

LAMPPIRAN

ISLAM



INDONESIA

UNIVERSITAS ISLAM INDONESIA

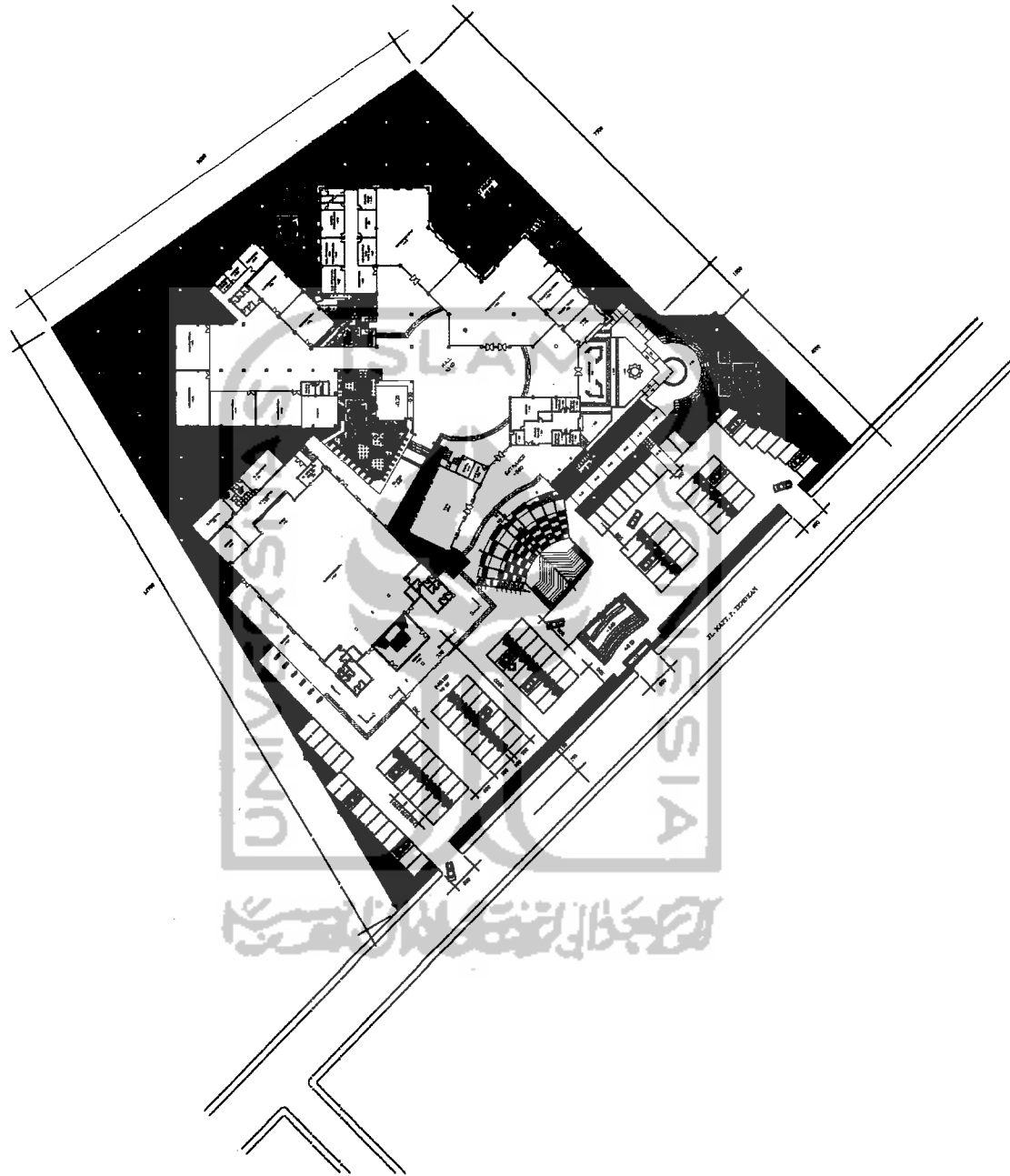

TUGAS AKHIR
 JURUSAN ARSITEKTUR
 FAKULTAS TEKNIK SIPIL DAN PERENCANAAN
 UNIVERSITAS ISLAM INDONESIA

PERIODE III
 SEMESTER GENAP
 TAHUN AKADEMIK
 2012 / 2013

**PUSAT KEGIATAN
 UMAT ISLAM BENGKULU**

DOSEN PEMBIMBING	IDENTITAS MAHASISWA	JUDUL GAMBAR	SKALA	LEMBAR KE	JUMLAH LEMBAR	PENYESAHAN
IR. TONY KUNTO WIBISONO	NAMA	EKO KASTION	SITE PLAN 1 : 1500			
	NO. MAHASISWA	98512028				
	TANDA TANGAN					

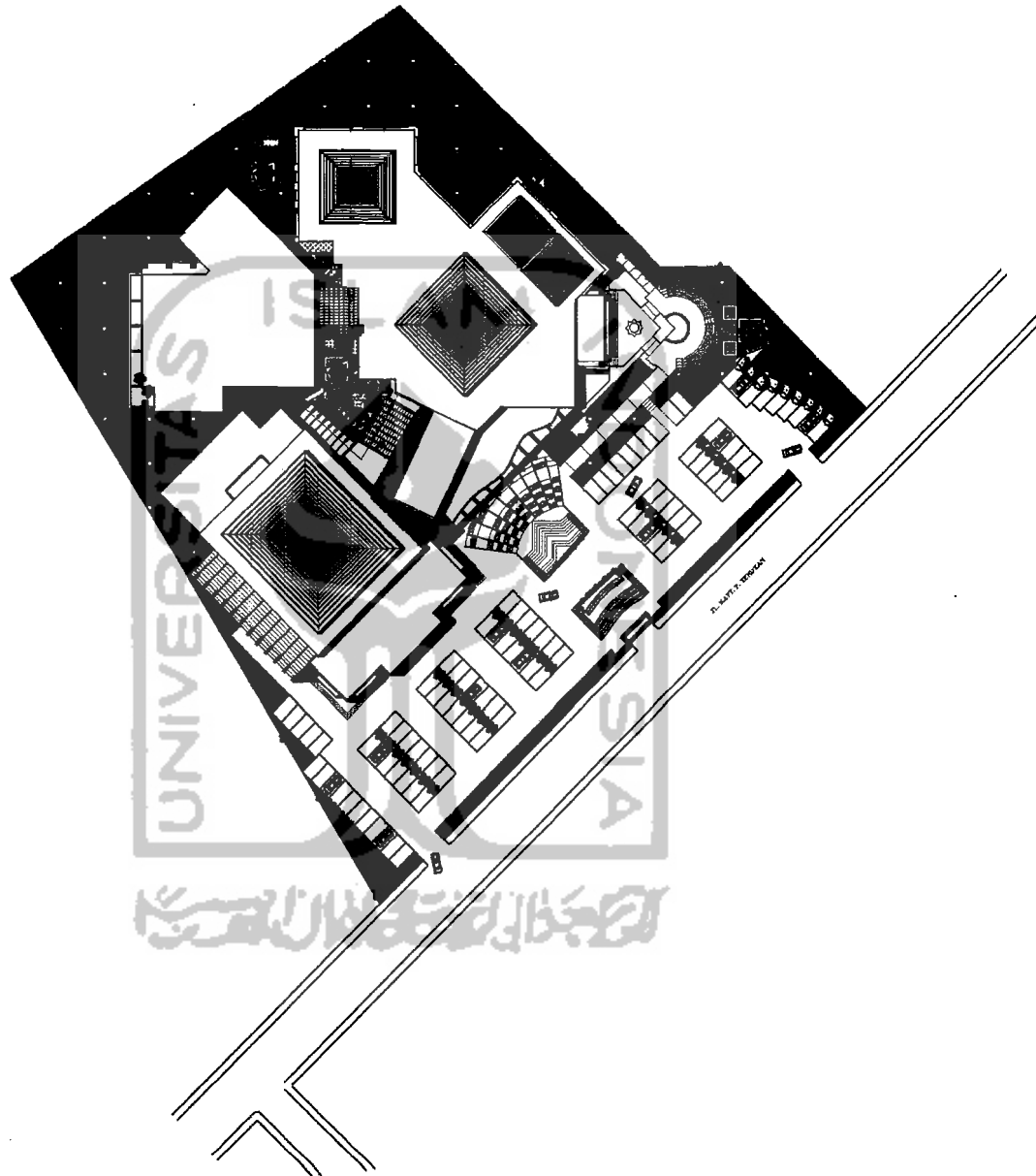

TUGAS AKHIR
 JURUSAN ARSITEKTUR
 FAKULTAS TEKNIK SIPIL DAN PERENCANAAN
 UNIVERSITAS ISLAM INDONESIA

PERIODE III
 SEMESTER GENAP
 TAHUN AKADEMIK
 2002 / 2003

**PUSAT KEGIATAN
 UMAT ISLAM BENGKULU**

DOSEN PEMBIMBING	IDENTITAS MAHASISWA		JUDUL GAMBAR	SKALA	LEMBAR KE	JUMLAH LEMBAR	PENGESAHAN
IR. TONY KUNTO WIBRONO	NAMA	EKO KASTON	SITUASI	1 : 200			
	NO MAHASISWA	06512008					
	TANDA TANGAN						

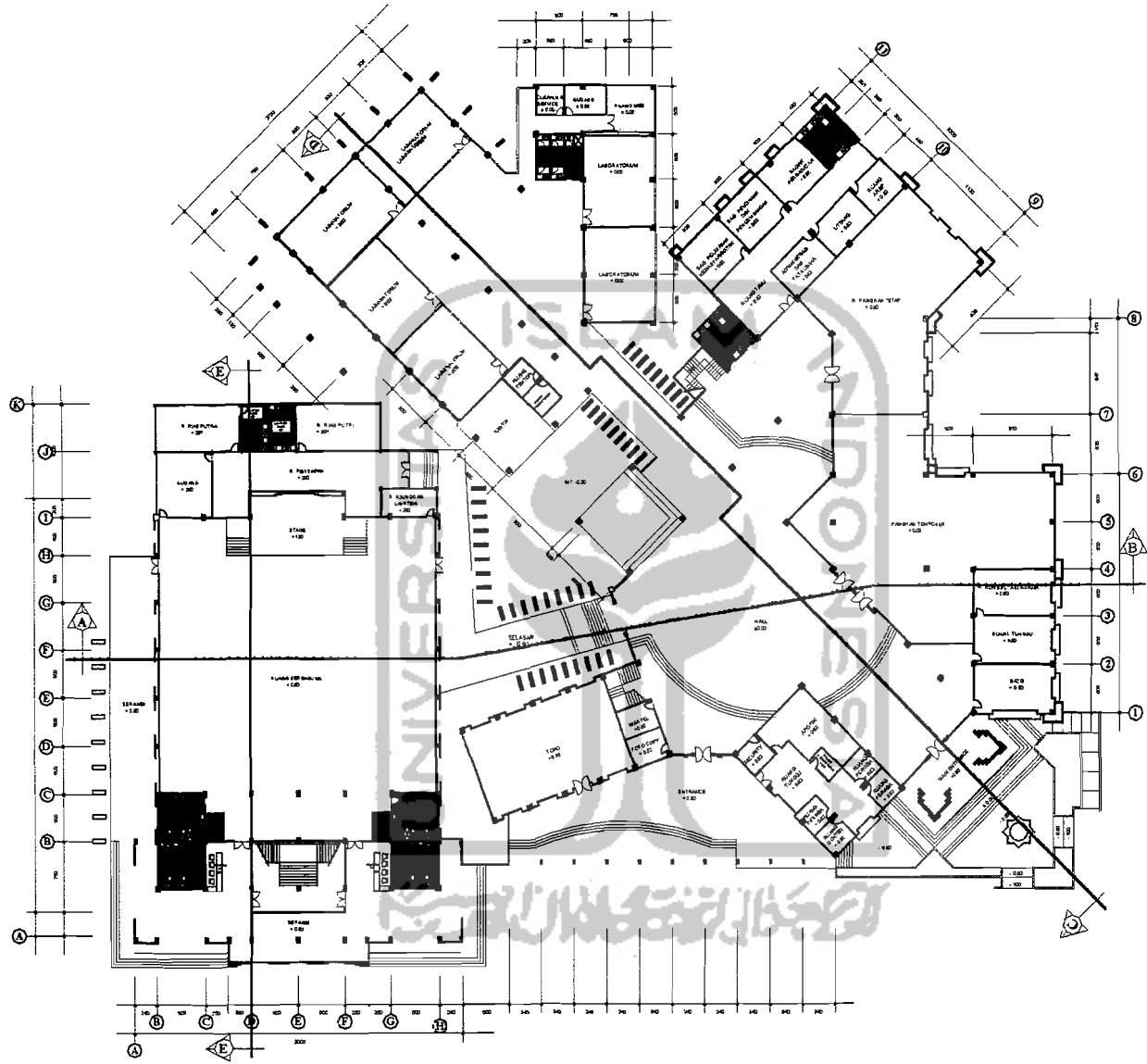

DENAH LANTAI
D A S A R



TUGAS AKHIR
JURUSAN ARSITEKTUR
FAKULTAS TEKNIK SIPIL DAN PERENCANAAN
UNIVERSITAS ISLAM INDONESIA

PERIODE III
SEMESTER GENAP
TAHUN AKADEMIK
2002 / 2003

**PUSAT KEGIATAN
UMAT ISLAM BENGKULU**

DOSEN PEMBIMBING	IDENTITAS MAHASISWA		JUDUL GAMBAR	SKALA	LEMBAR KE	JUMLAH LEMBAR	PENGESAHAN
IR. TONY HUNTO WIBISONO	NAMA	EKO ASTRON	DENAH LT. DASAR	1 : 750			
	NO MAHASISWA	98512008					
	TANGGA TANGAN						



TOTAL AKTIF
 JURUSAN ARSITEKTUR
 FAKULTAS TEKNIK SIPIL DAN PERENCANAAN
 UNIVERSITAS ISLAM BENGKULU

PERIODE III
 BANGUNAN
 TAHAP AKHIR
 2002/2003

**PUSAT KEGIATAN
 UMAT ISLAM BENGKULU**

COSEN PERENCANAAN
 IR. TOMY HANNO NURBANDI

NAMA	IDENTITAS MAHASISWA
NO. MAHASISWA	EKO KASTON
NAMA TAMBAH	

JUDUL GAMBAR
 DENAH L.T. SATU

SKALA
 1 : 750

LEMBAR
 JUMLAH LEMBAR
 PERENCANAAN

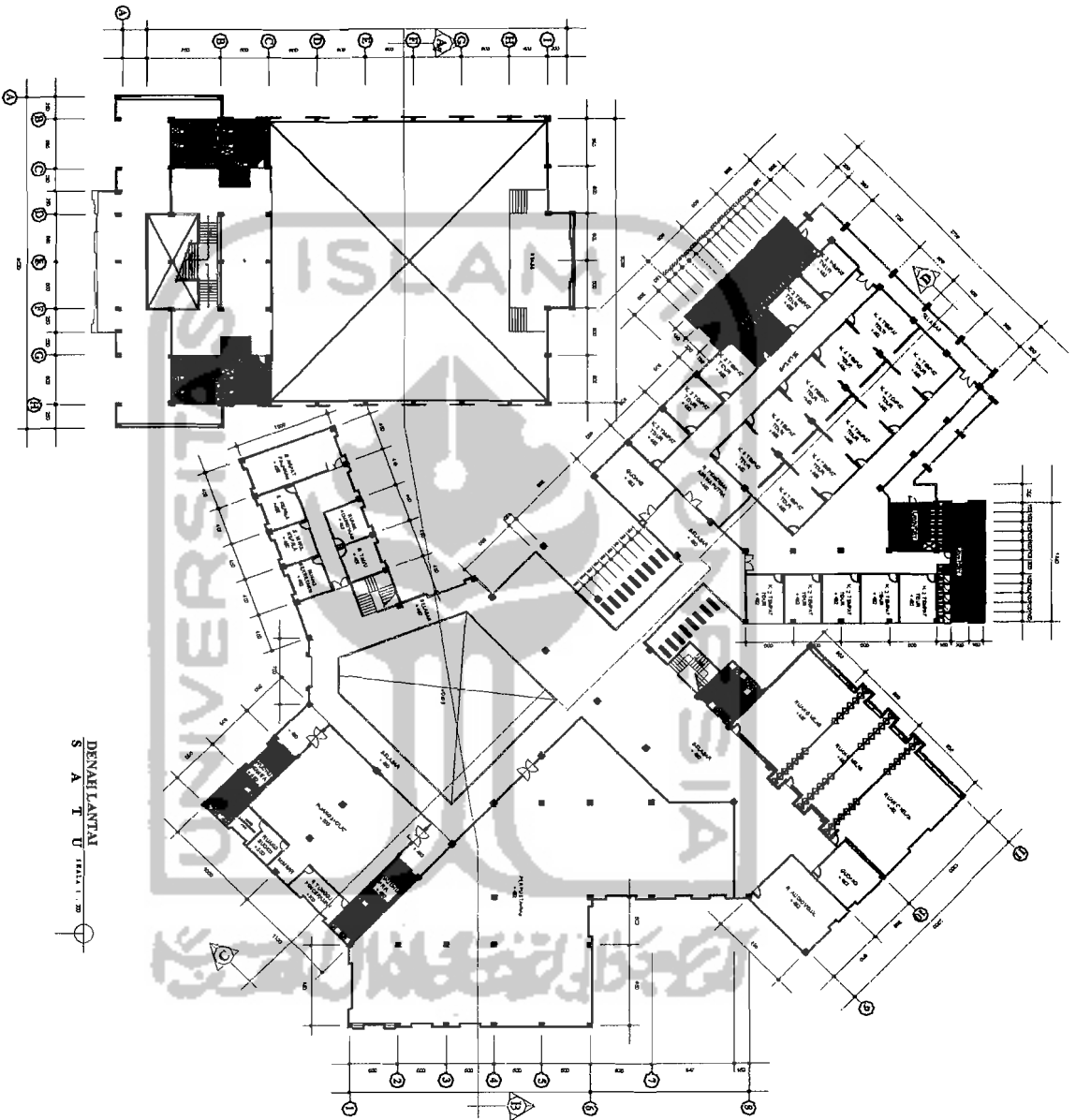

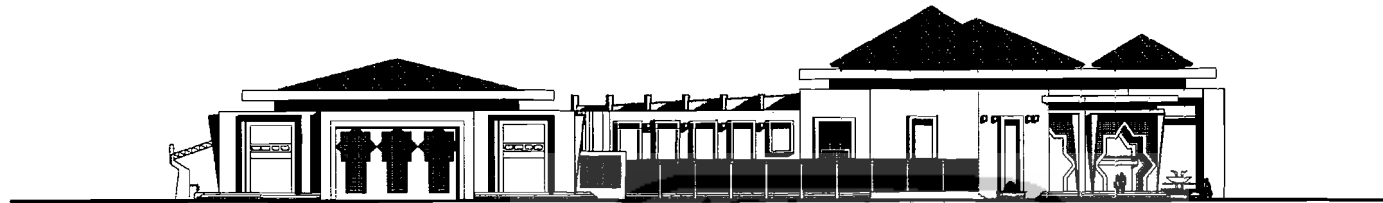

TAMPAK
A - B SKALA 1 : 20



TAMPAK
B A R A T SKALA 1 : 20



TAMPAK
C - D SKALA 1 : 20

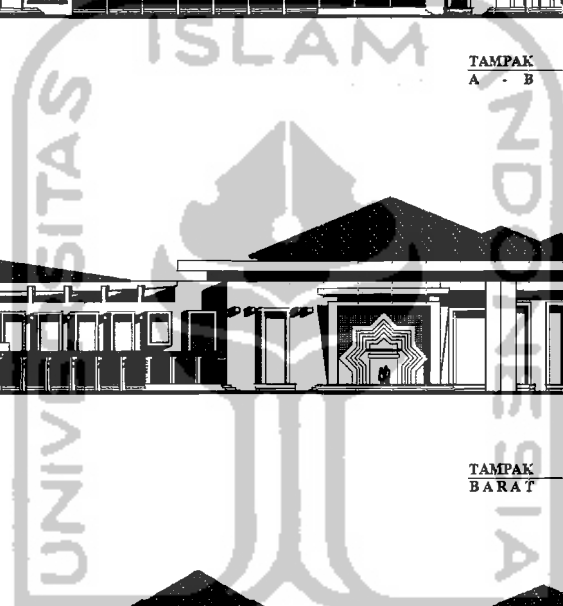

TUGAS AKHIR
JURUSAN ARSITEKTUR
FAKULTAS TEKNIK SIPIL DAN PERENCANAAN
UNIVERSITAS ISLAM INDONESIA

PERIODE III
SEMESTER GENAP
TAHUN AKADEMIK
2002 / 2003

**PUSAT KEGIATAN
UMAT ISLAM BENGKULU**

DOSEN PEMBIMBING	IDENTITAS MAHASISWA	JUJUL GAMBAR	SKALA	LEMBAR KE	JUMLAH LEMBAR	PENGESAHAN
IR. TONY KUNTO WIBISONO	NAMA	EKO KASTON	TAMPAK	1 : 750		
	NO MAHASISWA	08512009				
	TANDA TANGAN					

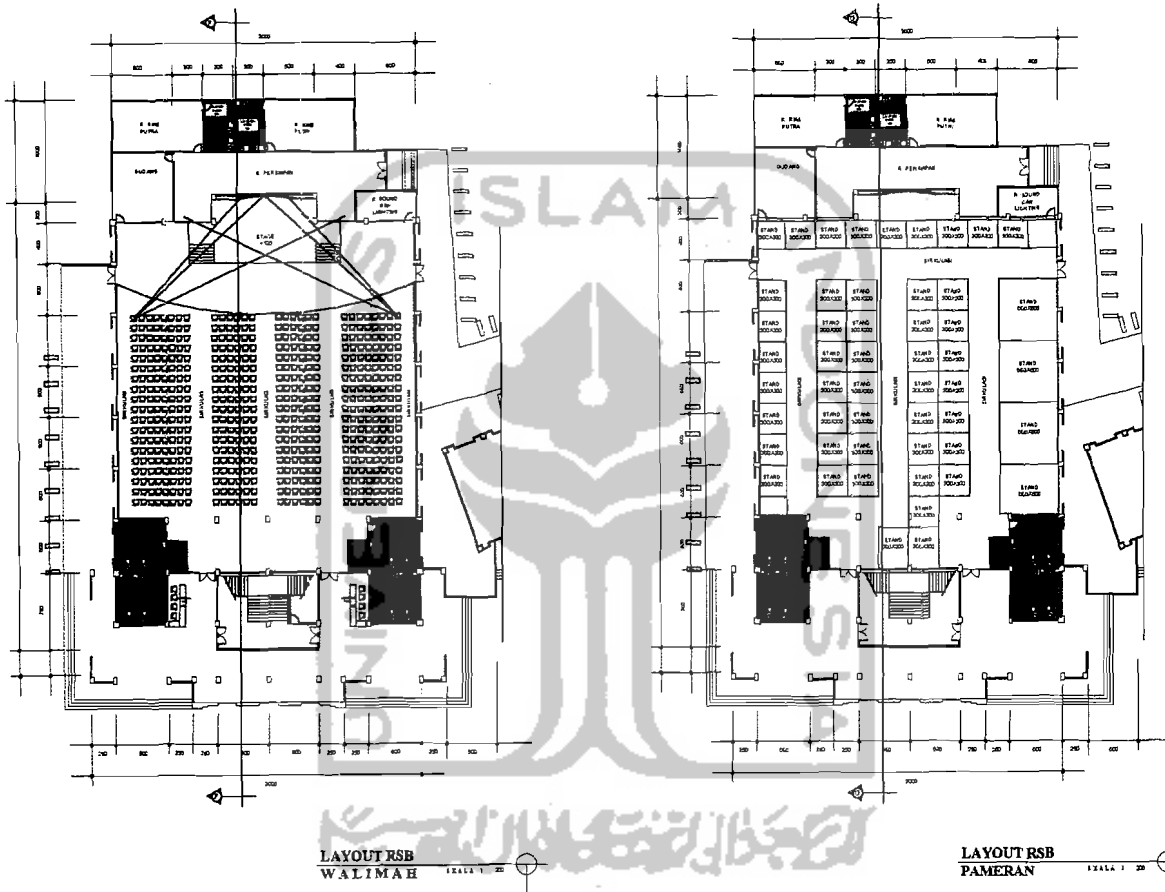

LAYOUT RSB
WALIMAH

LAYOUT RSB
PAMERAN



TUGAS AKHIR
JURUSAN ARSITEKTUR
FAKULTAS TEKNIK SIPIL DAN REKONSTRUKSI
UNIVERSITAS ISLAM INDONESIA

PERIODE III
SEMESTER GENAP
TAHUN AKADEMIK
2002 / 2003

**PUSAT KEGIATAN
UMAT ISLAM BENGKULU**

DOSEN PEMBIMBING	IDENTITAS MAHASISWA	JUDUL GAMBAR	SKALA	LEMBAR KE	JUMLAH LEMBAR	PENGESAHAN
IR. TONY KLIMTO WIBISONO	NAMA	EKO KASTIGI	LAY OUT RUANG	1 : 750		
	NO. MAHASISWA	89512008				
	TANDA TANGAN					

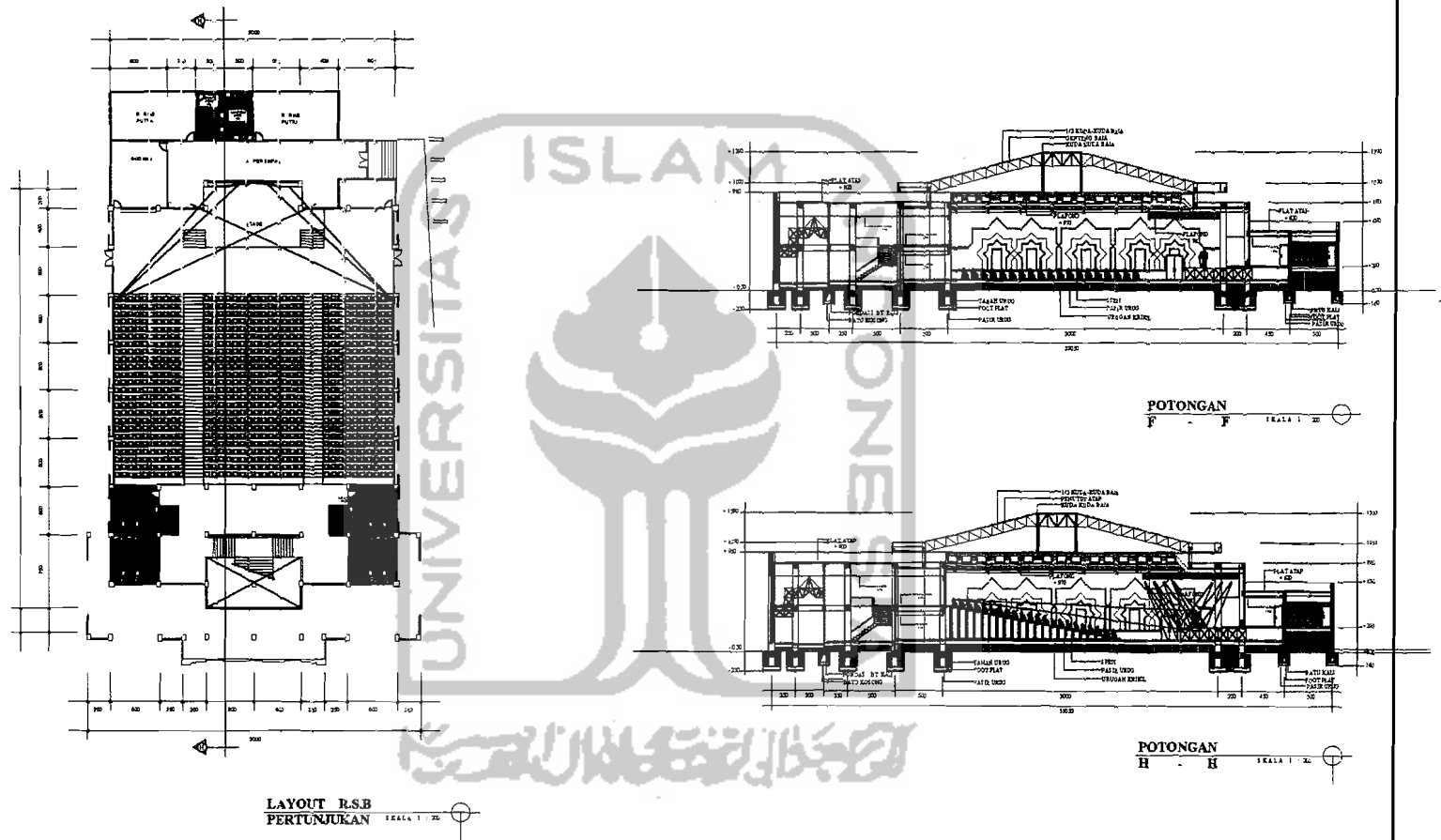

TUGAS AKHIR
JURUSAN ARSITEKTUR
FAKULTAS TEKNIK SIPIL DAN PERENCANAAN
UNIVERSITAS ISLAM INDONESIA

PERIODE III
SEMESTER GENAP
TAHUN AKADEMIK
2002 / 2003

**PUSAT KEGIATAN
UMAT ISLAM BENGKULU**

DOSEN PEMBIMBING	IDENTITAS MAHASISWA		JUDUL GAMBAR	SKALA	LEMBAR KE	JUMLAH LEMBAR	PENGESAHAN
IR. TONY KUNTO WIBISONO	NAMA	EKO KASTON	LAY OUT RUANG POTONGAN	1 : 750			
	NO. N.P./ASSIYA	98512008					
	TANDA TANGAN						

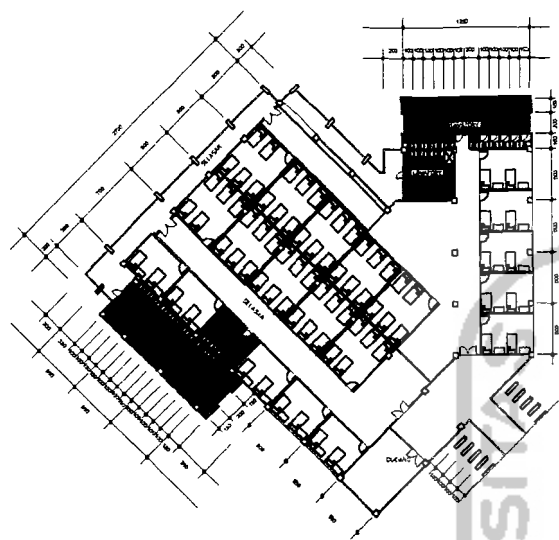

LAY OUT
RUANG ASRAMA

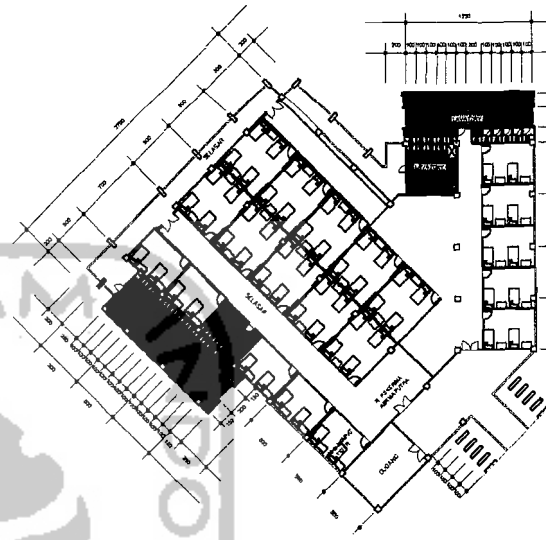

LAY OUT
RUANG ASRAMA

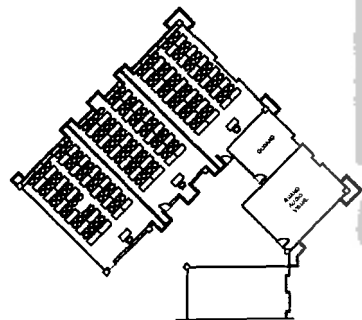

LAY OUT
RUANG KELAS

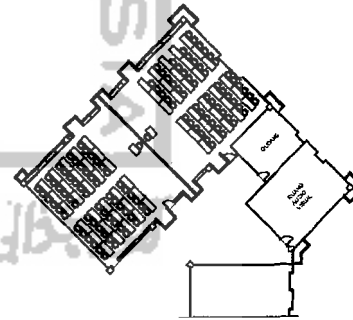

LAY OUT
RUANG KELAS

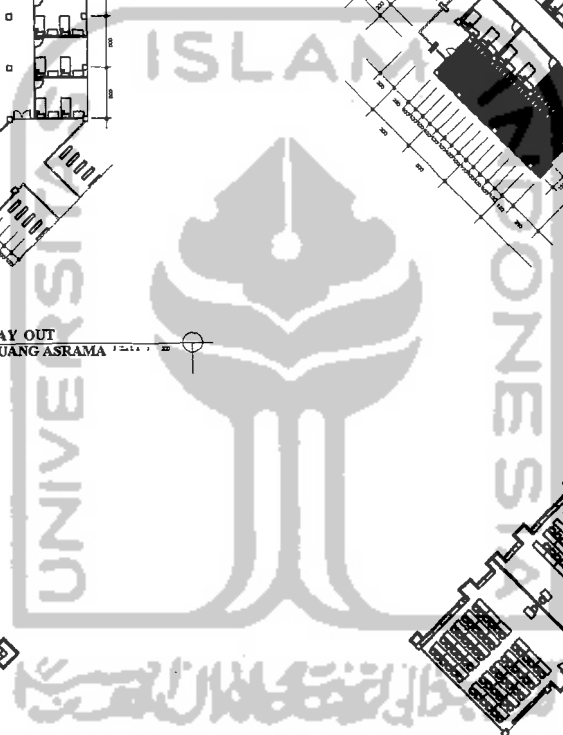

TUGAS AKHIR
JURUSAN ARSITEKTUR
FAKULTAS TEKNIK SIPIL DAN PERENCANAAN
UNIVERSITAS ISLAM INDONESIA

PERIODE III
SEMESTER GENAP
TAHUN AKADEMIK
2022 / 2023

**PUSAT KEGIATAN
UMAT ISLAM BENGKULU**

DOSEN PEMBIMBING	IDENTITAS MAHASISWA	JUDUL GAMBAR	SKALA	LEMBAR KE	JUMLAH LEMBAR	REVISI	PERSEKSESAN
IR. TONY KUNTO WIBISONO	NAMA: EKO KASTON NO MAHASISWA: 98512008 TANDA TANGAN:	LAY OUT RUANG	1 : 750				

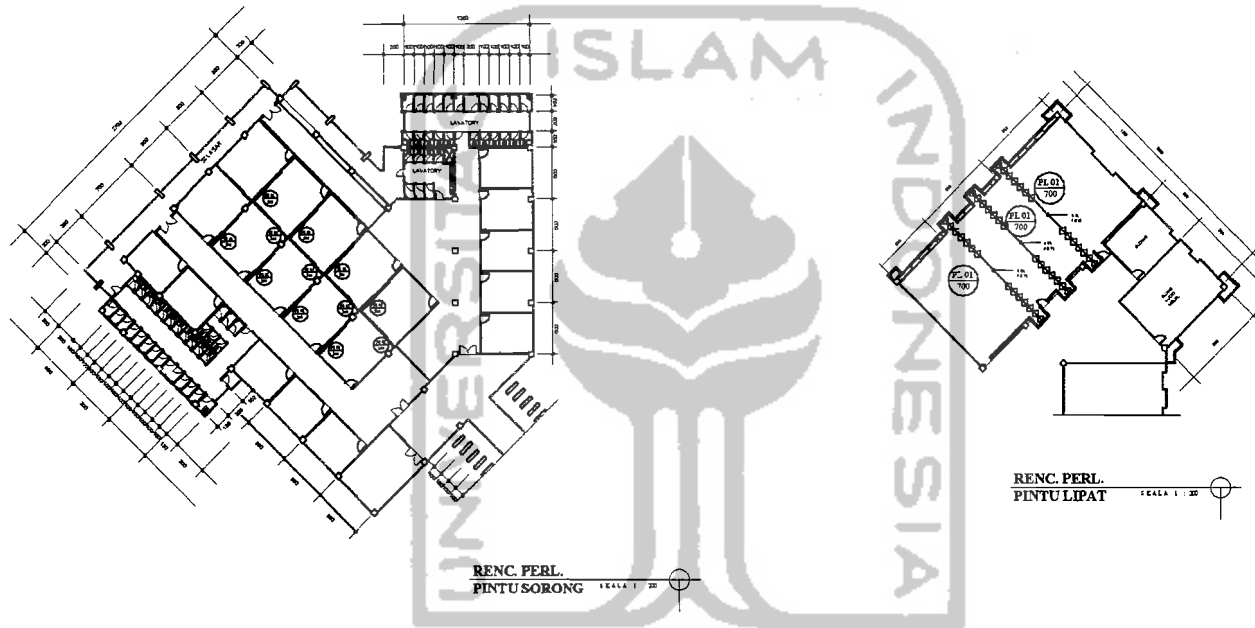

TUGAS AKHIR
 JURUSAN ARSITEKTUR
 FAKULTAS TEKNIK BILAI DAN PERENCANAAN
 UNIVERSITAS ISLAM INDONESIA

PERIODE III
 SEMESTER GENAP
 TAHUN AKADEMIK
 2022 / 2023

**PUSAT KEGIATAN
 UMAT ISLAM BENGKULU**

DOSEN PEMBIMBING	IDENTITAS MAHASISWA		JUDUL GAMBAR	SKALA	LEMBAR KE	JUMLAH LEMBAR	REVISI/REVISI
IR. TONY KUNTO WIBISONO	NAMA	ENOK KASTIEN	RENC. PERLETAKAN PINTU	1 : 750			
	NO MAHASISWA	88512008					
	TANDA TANGAN						

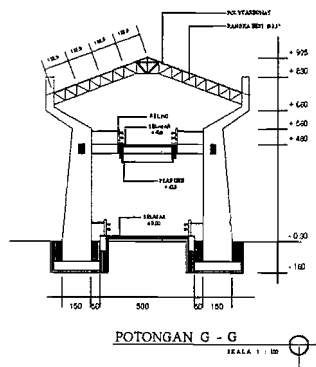
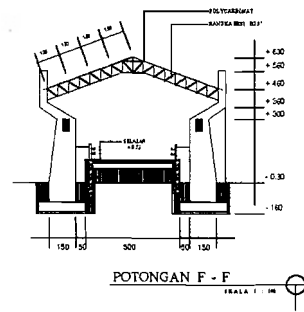
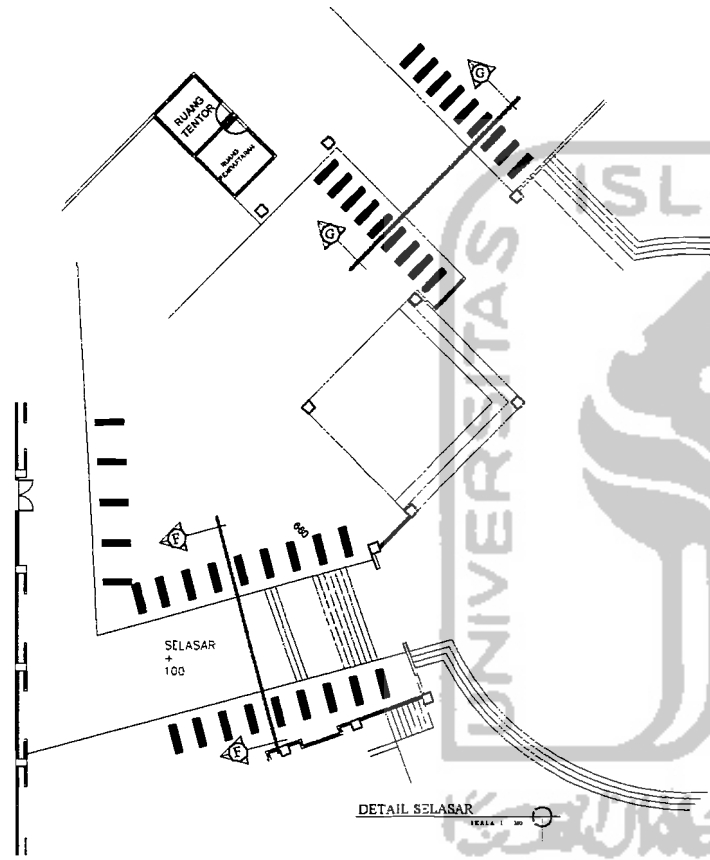

TUGAS AKHIR
JURUSAN ARSITEKTUR
FAKULTAS TEKNIK, REKREASI DAN PEMERIKHAAN
UNIVERSITAS ISLAM INDONESIA

PERIODE III
SEMESTER GENAP
TAJUK AKADEMIK
2002 / 2003

**PUSAT KEGIATAN
UMAT ISLAM BENGKULU**

Dosen Pembimbing
IR. TONY KUNTO WIBISONO

IDENTITAS MAHASISWA
NAMA: **EKO KASTON**
NOMOR NASISWA: **35512003**
TANDA TANGAN:

JUDUL GAMBAR
POTONGAN SELASAR

SKALA
1 : 400

LEMBAR KE: []
JUMLAH LEMBAR: []
PENGELOMPOK: []

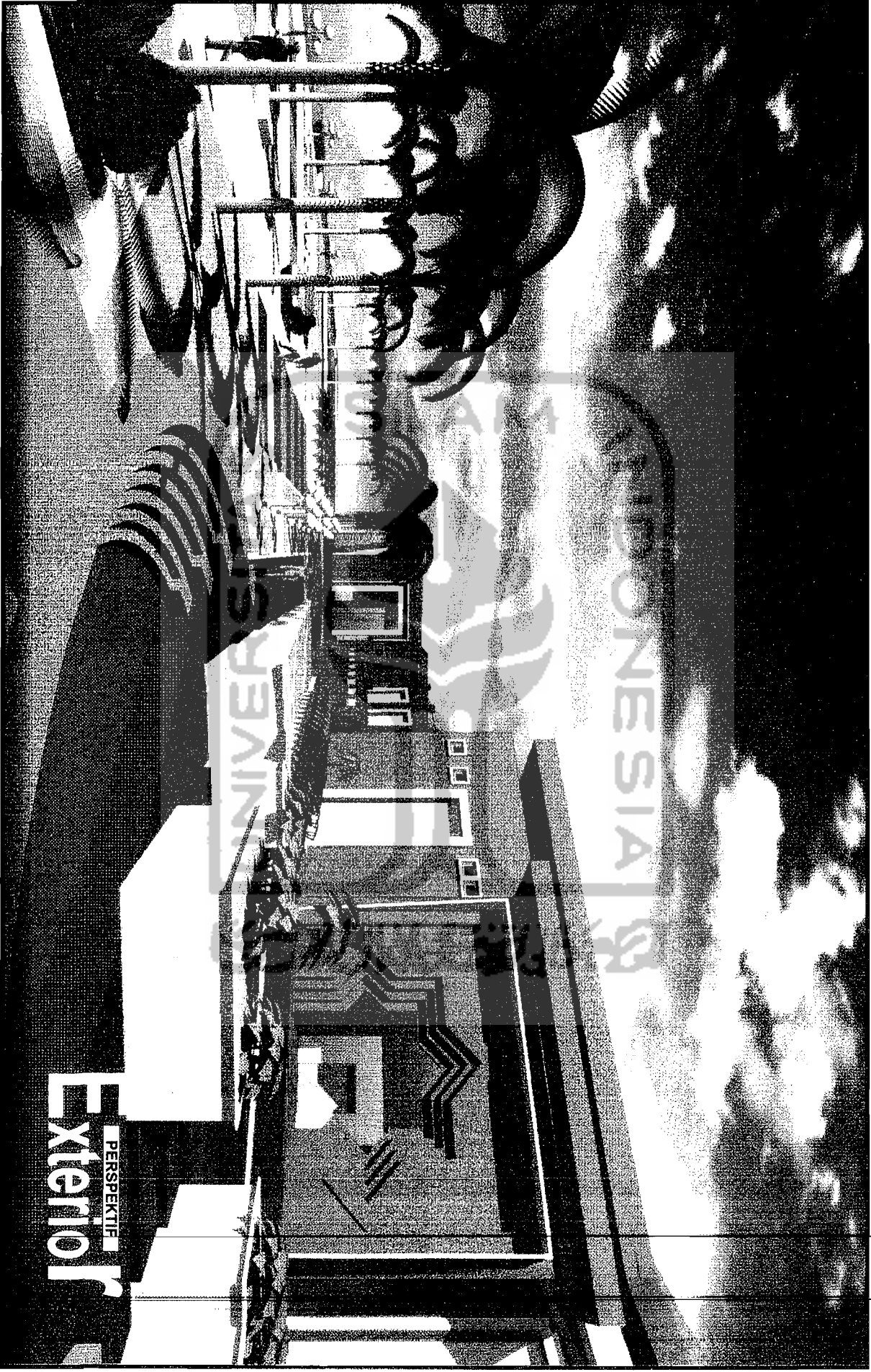

PERSPEKTIF
Exterior



UNIVERSITAI

PERSEKTI
Exterior

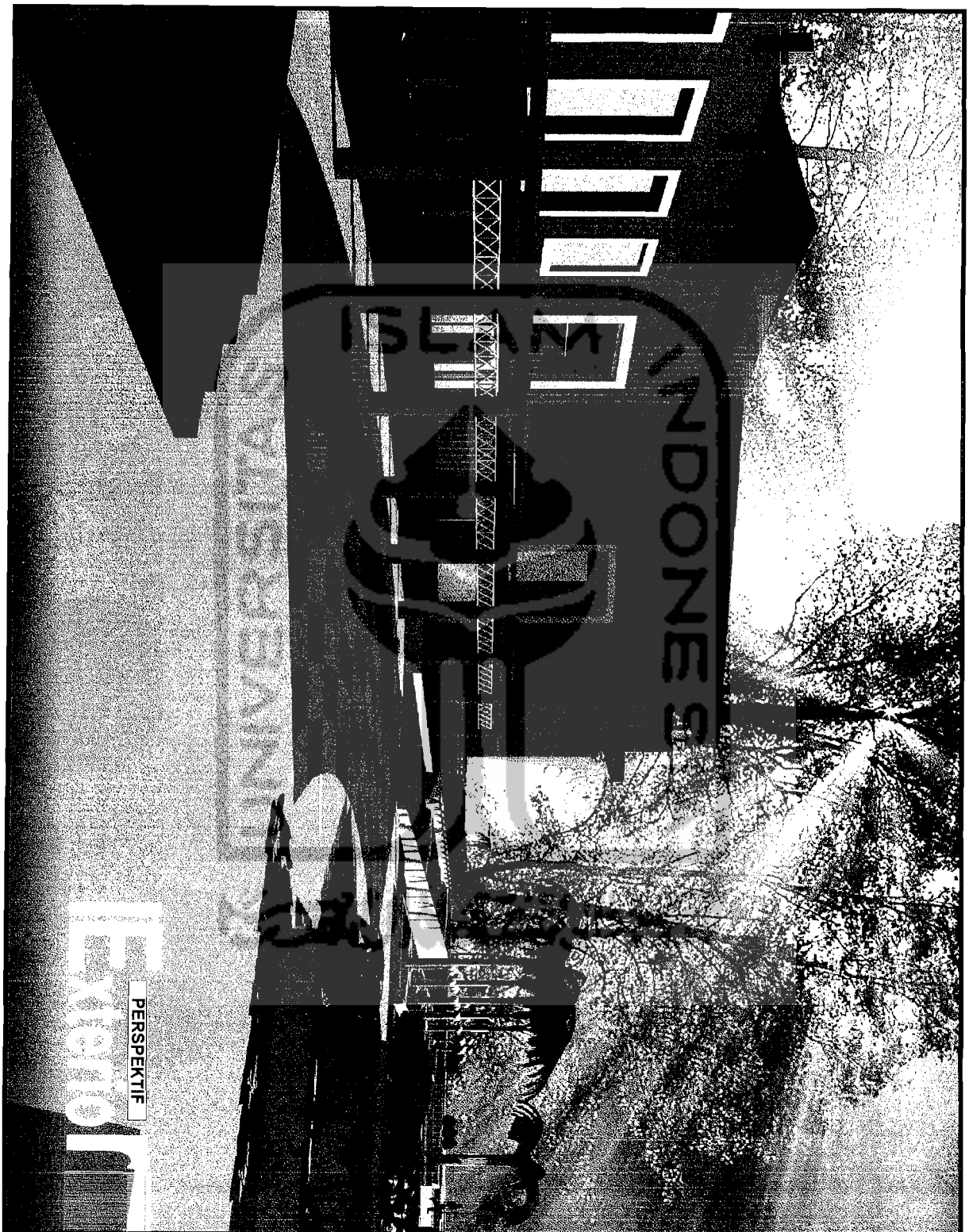

PERSPEKTIF
Ekstero



R INTERIOR
Ruang Sebaguna

HAL

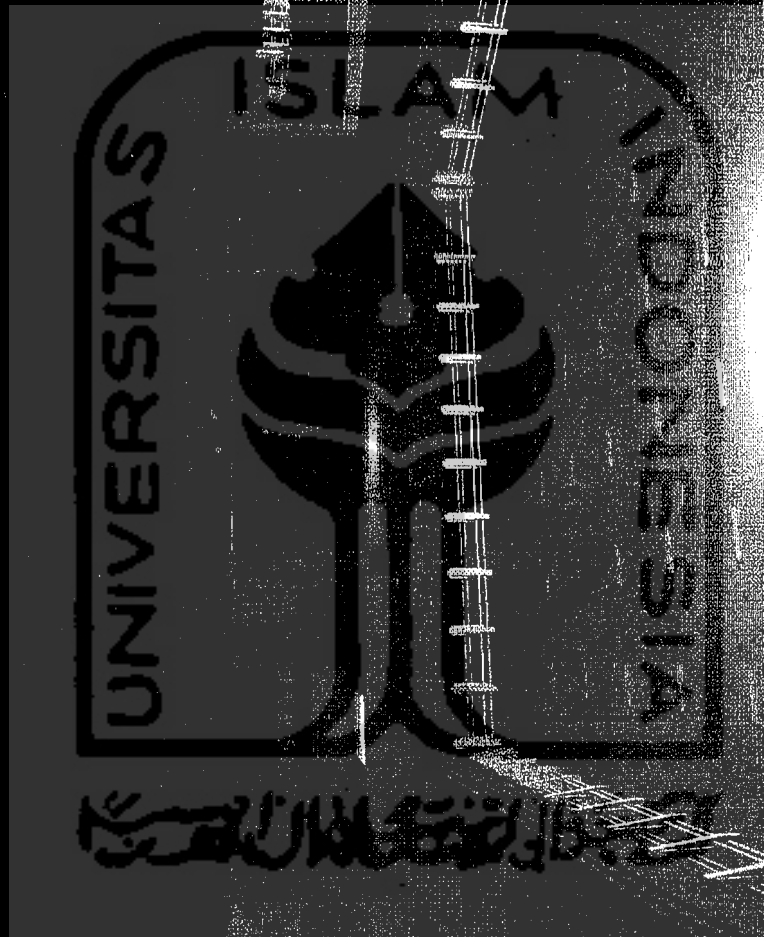



UNIVERSITAS
SIAM
PERSPEKTIF

Selasar
PERSPEKTIF

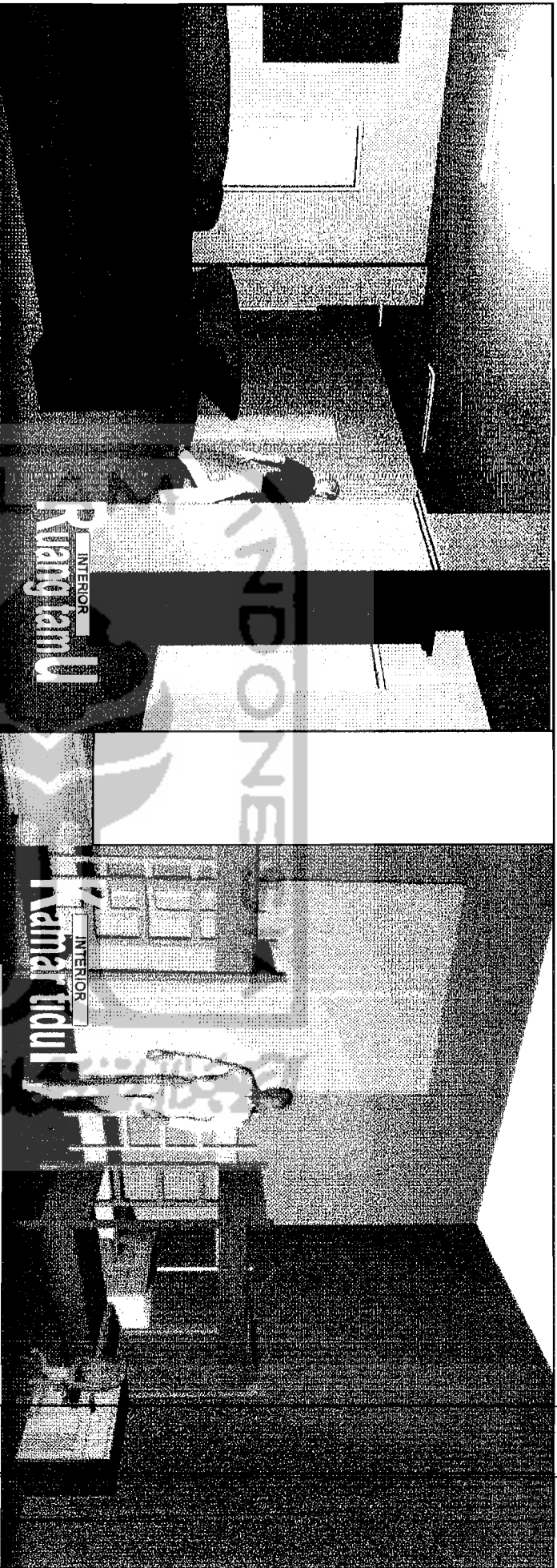

INTERIOR
Ruang tamu

INTERIOR
Kamar tidur



INTERIOR
Ruang tamu



INTERIOR
Asrama

