

○ SKEMA PENCAHAYAAN



JURUSAN ARSITEKTUR  
FAKULTAS TEKNIK SIPIL  
DAN PERENCANAAN  
UNIVERSITAS ISLAM  
INDONESIA

PROYEK AKHIR  
SARJANA



IDENTITAS  
MAHASISWA

Sholli Cholik Rifa,i  
14512168

DOSEN  
PEMBIMBING

Yulia Pratiwi, S.T., M.Eng

NAMA GAMBAR

Skema Pencahayaan

SKALA

KETERANGAN

NO OF PAGE

PAGE

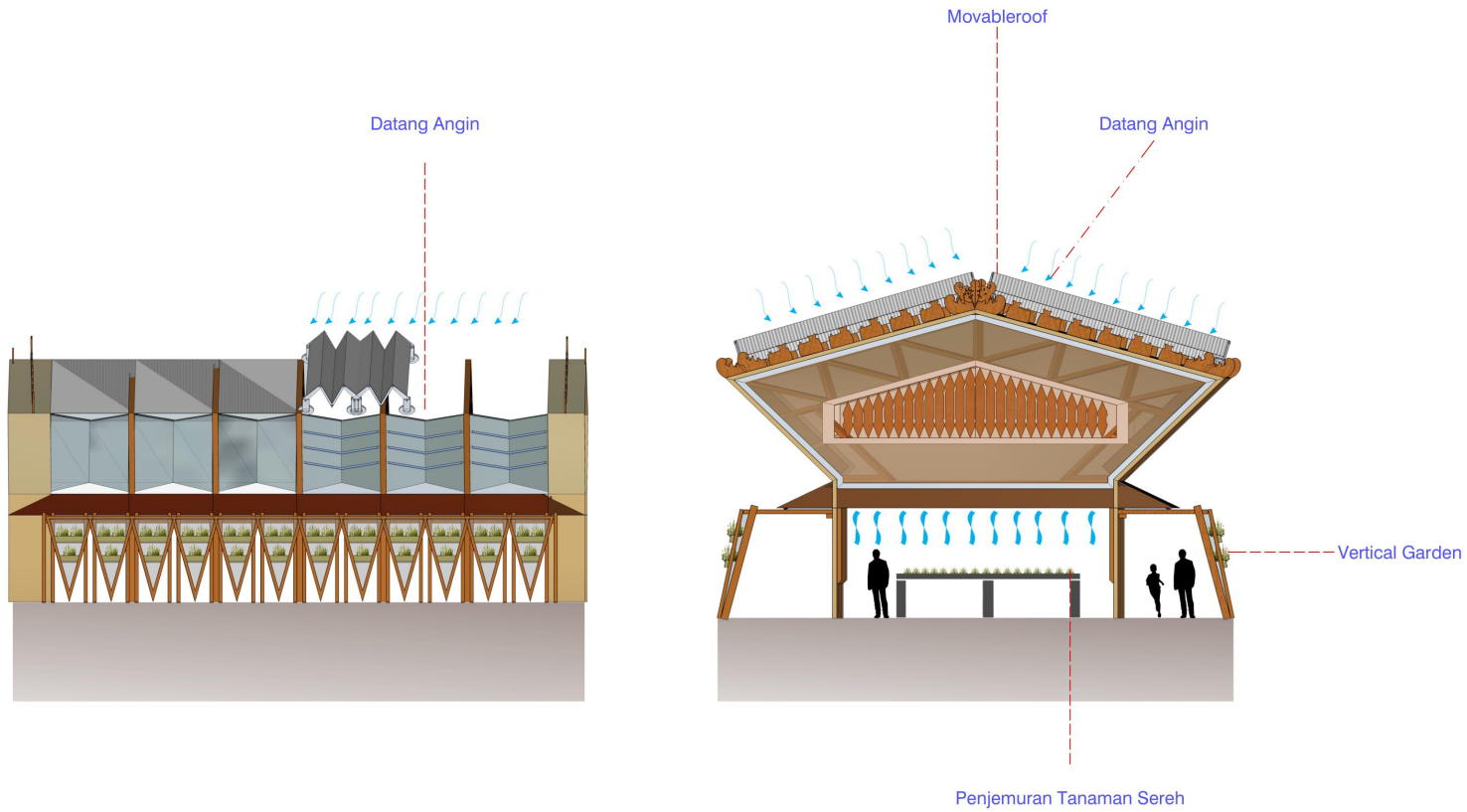

○ SKEMA PENGHAWAAN



JURUSAN ARSITEKTUR  
FAKULTAS TEKNIK SIPIL  
DAN PERENCANAAN  
UNIVERSITAS ISLAM  
INDONESIA

PROYEK AKHIR  
SARJANA



IDENTITAS  
MAHASISWA

Sholli Cholik Rifa,i  
14512168

DOSEN  
PEMBIMBING

Yulia Pratiwi, S.T., M.Eng

NAMA GAMBAR

Skema Penghawaan

SKALA

KETERANGAN

NO OF PAGE

PAGE



JURUSAN ARSITEKTUR  
FAKULTAS TEKNIK SIPIL  
DAN PERENCANAAN  
UNIVERSITAS ISLAM  
INDONESIA

PROYEK AKHIR  
SARJANA



IDENTITAS  
MAHASISWA

Sholli Cholik Rifa,i  
14512168

DOSEN  
PEMBIMBING

Yulia Pratiwi, S.T., M.Eng

NAMA GAMBAR

Skema Penanggulangan  
Kebakaran dan Sirkulasi Darurat

SKALA



Skala 1 : 500

KETERANGAN

NO OF PAGE

PAGE

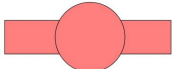
Legenda :

-  : Hydrant Box
-  : Hydrant Post
-  : Assambly Point
-  : Jalur Evakuasi



Skema Kebakaran dan Sirkulasi Darurat  
Skala 1 : 500

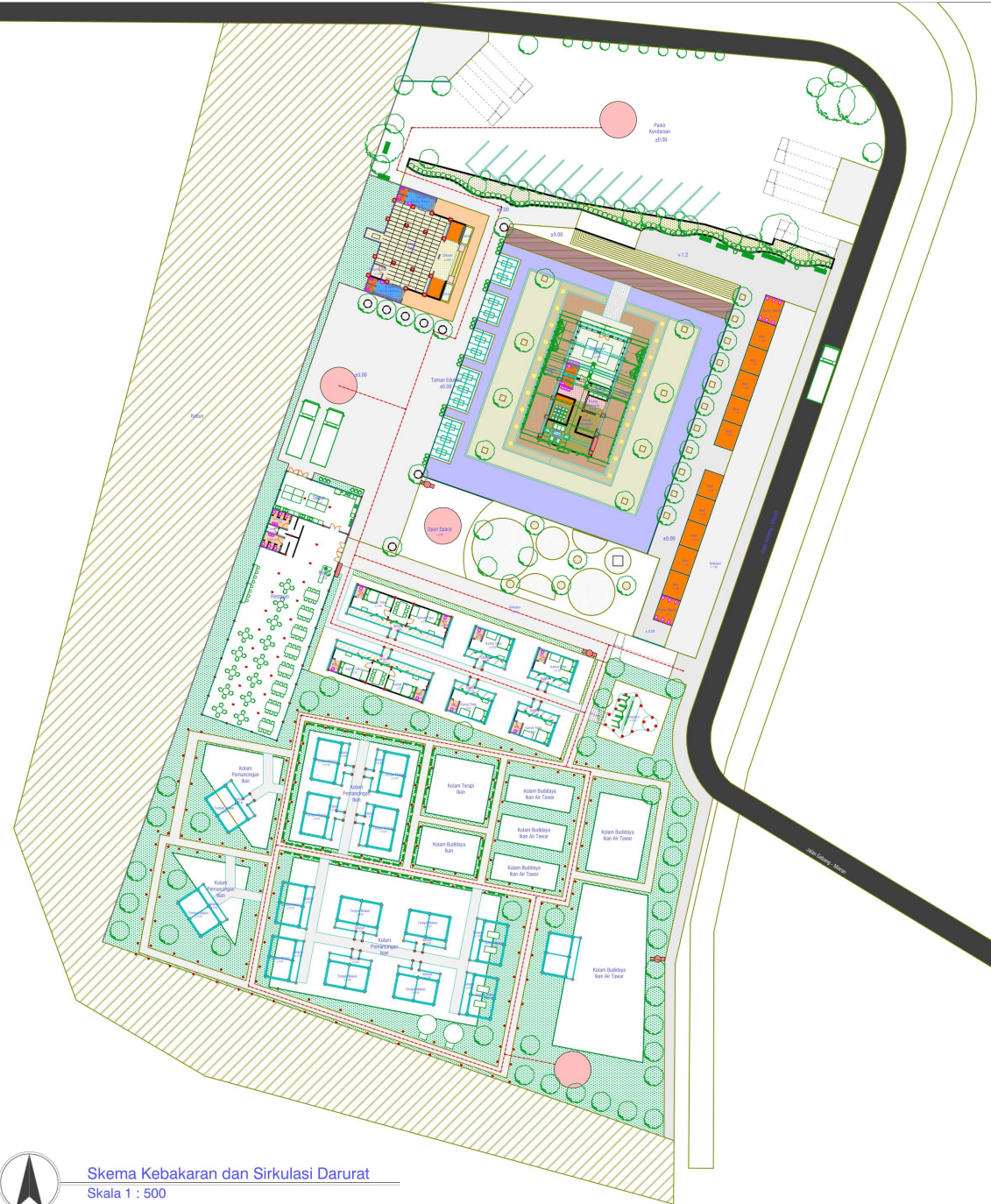



JURUSAN ARSITEKTUR  
FAKULTAS TEKNIK SIPIL  
DAN PERENCANAAN  
UNIVERSITAS ISLAM  
INDONESIA

PROYEK AKHIR  
SARJANA



IDENTITAS  
MAHASISWA

Sholli Cholik Rifa,i  
14512168

DOSEN  
PEMBIMBING

Yulia Pratiwi, S.T., M.Eng

NAMA GAMBAR

Skema Barrier 1

SKALA

Skala 1: 100

KETERANGAN

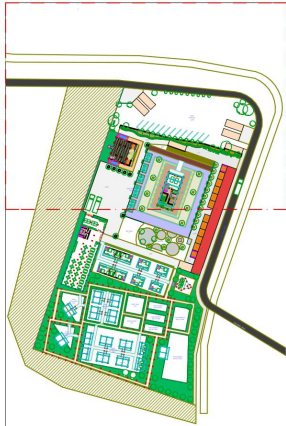

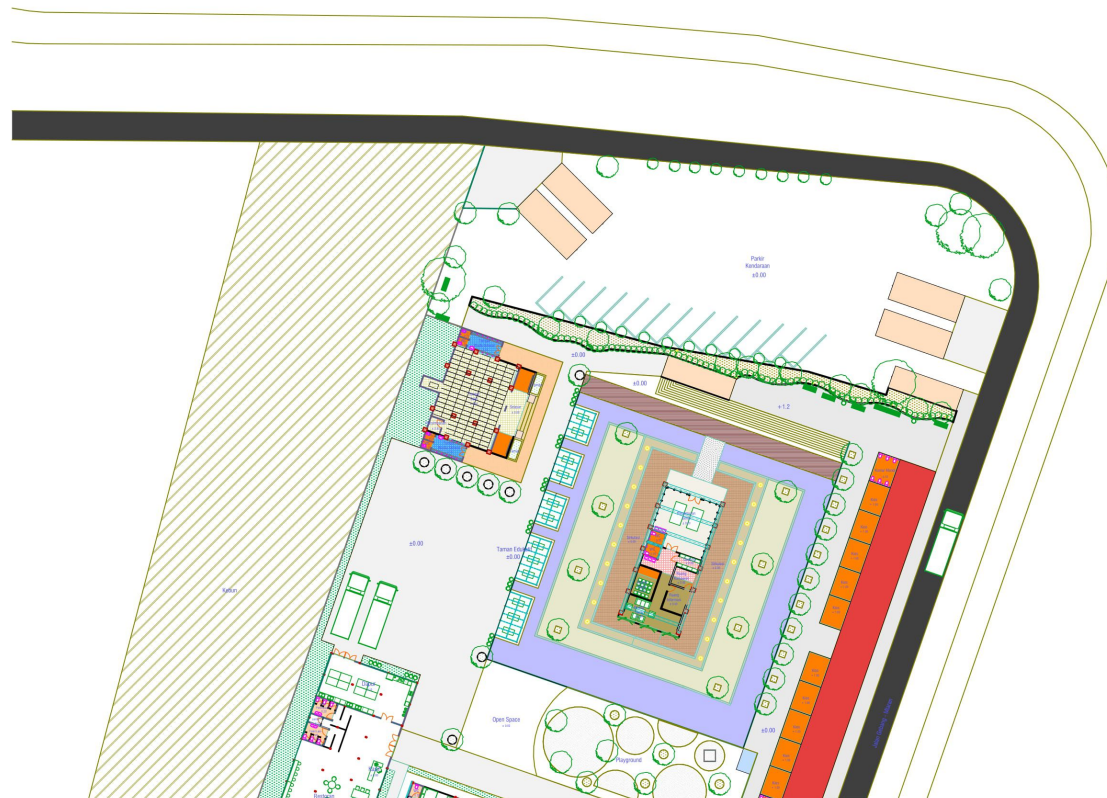

Masterplane  
Skala 1 : 2000



Skema Barrier Siteplane 1  
Skala 1 : 100

Legenda :

-  : Ramp
-  : Tangga
-  : Dropoff Difable

NO OF PAGE

PAGE



JURUSAN ARSITEKTUR  
FAKULTAS TEKNIK SIPIL  
DAN PERENCANAAN  
UNIVERSITAS ISLAM  
INDONESIA

PROYEK AKHIR  
SARJANA



IDENTITAS  
MAHASISWA

Sholli Cholik Rifa,i  
14512168

DOSEN  
PEMBIMBING

Yulia Pratiwi, S.T., M.Eng

NAMA GAMBAR

Skema Barrier 2

SKALA

Skala 1 : 100

KETERANGAN

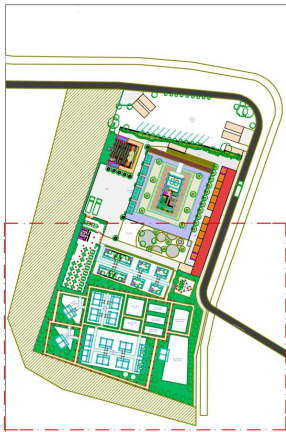

Masterplane  
Skala 1 : 2000



Skema Barrier Siteplane 2  
Skala 1 : 100

Legenda :

-  : Ramp
-  : Tangga
-  : Dropoff Difable

NO OF PAGE

PAGE



JURUSAN ARSITEKTUR  
FAKULTAS TEKNIK SIPIL  
DAN PERENCANAAN  
UNIVERSITAS ISLAM  
INDONESIA

PROYEK AKHIR  
SARJANA



IDENTITAS  
MAHASISWA

Sholli Cholik Rifa'i  
14512168

DOSEN  
PEMBIMBING

Yulia Pratiwi, S.T., M.Eng

NAMA GAMBAR

Detail Selubung

SKALA

KETERANGAN

NO OF PAGE

PAGE

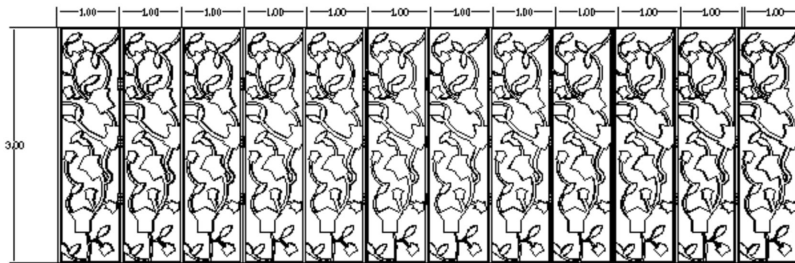

TAMPAK SAMPING

Skala 1 : 50

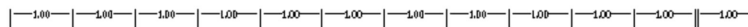

TAMPAK ATAS

Skala 1 : 100

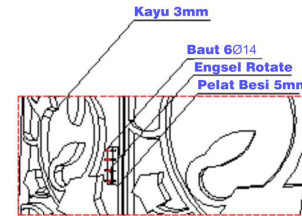

DETAIL

Skala 1 : 20

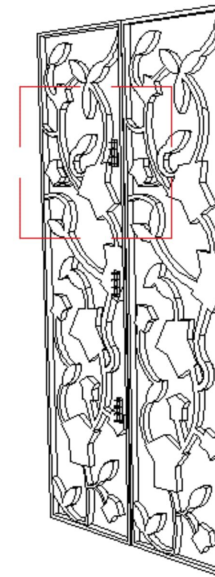

AKSONOMETRI



JURUSAN ARSITEKTUR  
FAKULTAS TEKNIK SIPIL  
DAN PERENCANAAN  
UNIVERSITAS ISLAM  
INDONESIA

PROYEK AKHIR  
SARJANA



IDENTITAS  
MAHASISWA

Sholli Cholik Rifa,i  
14512168

DOSEN  
PEMBIMBING

Yulia Pratiwi, S.T., M.Eng

NAMA GAMBAR

Detail Interior

SKALA

KETERANGAN

NO OF PAGE

PAGE

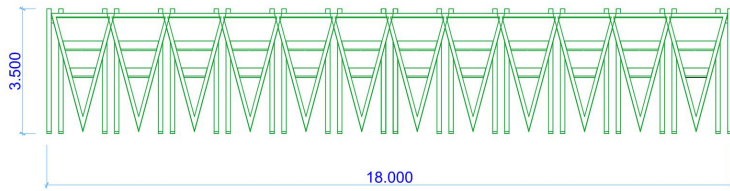

Tampak Samping  
Skala 1 : 100

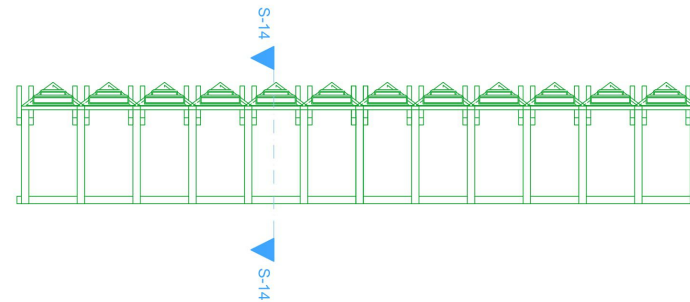

Tampak Atas  
Skala 1 : 100

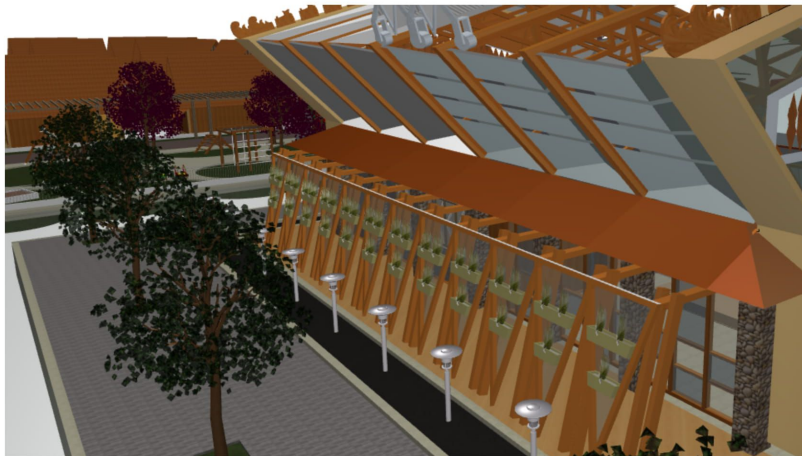

AKSONOMETRI

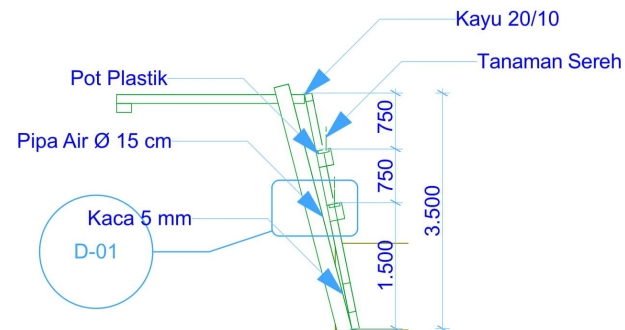

Potongan A-A'  
Skala 1 : 50

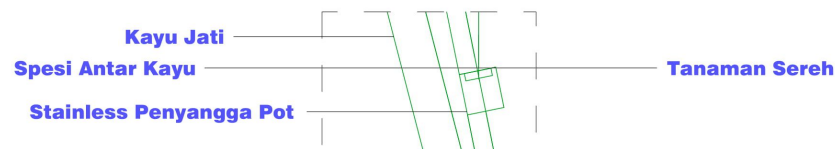

Detail 1  
Skala 1 : 20



JURUSAN ARSITEKTUR  
FAKULTAS TEKNIK SIPIL  
DAN PERENCANAAN  
UNIVERSITAS ISLAM  
INDONESIA

PROYEK AKHIR  
SARJANA



IDENTITAS  
MAHASISWA

Sholli Cholik Rifa,i  
14512168

DOSEN  
PEMBIMBING

Yulia Pratiwi, S.T., M.Eng

NAMA GAMBAR

Detail Arsitektur

SKALA

KETERANGAN

NO OF PAGE

PAGE

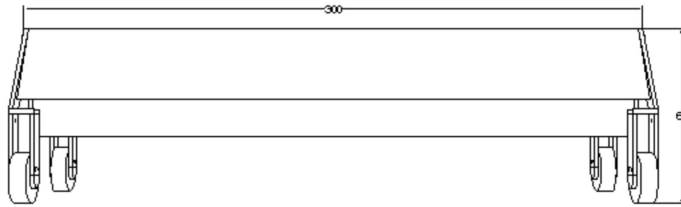

TAMPAK DEPAN  
Skala 1 : 50

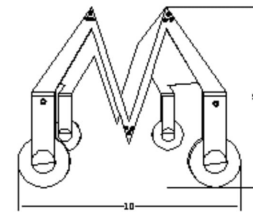

TAMPAK SAMPING  
Skala 1 : 50

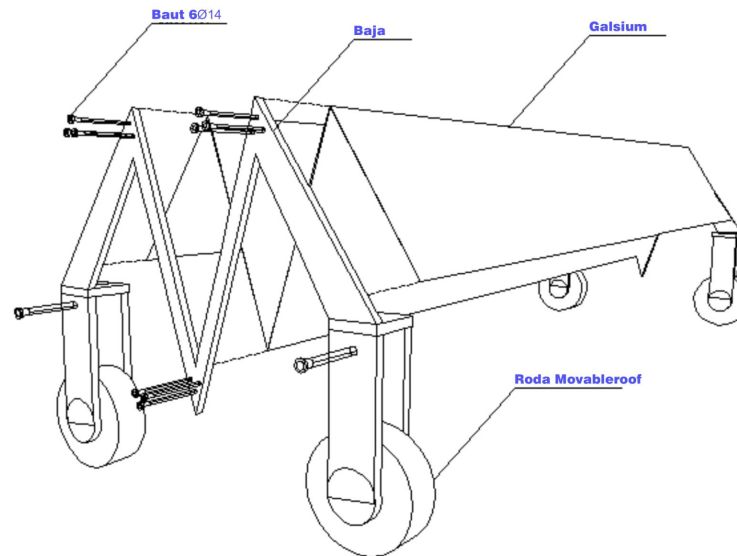

AKSONOMETRI DAN SAMBUNGAN





Openspace

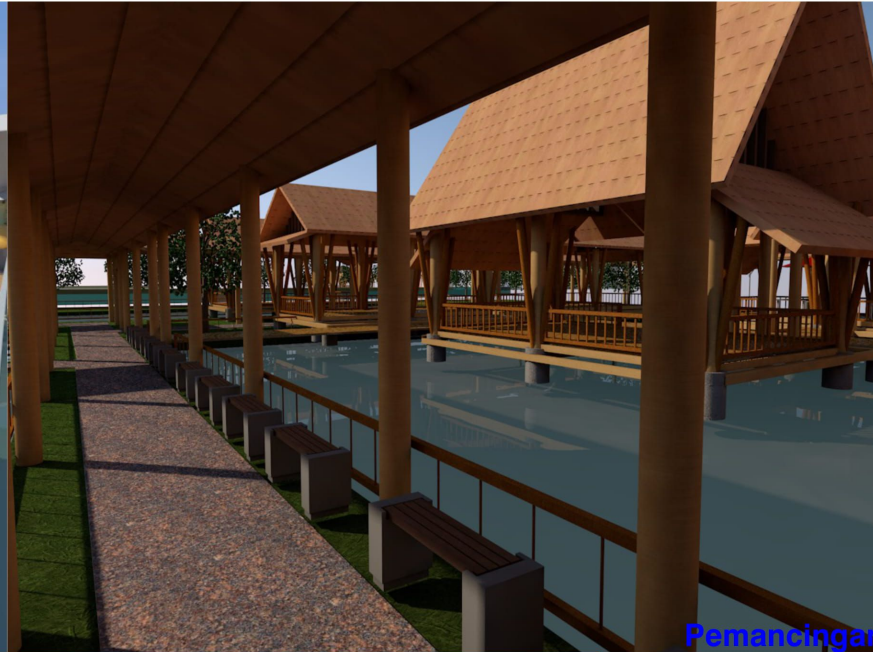

Pemancingan



Bungalow Resort



JURUSAN ARSITEKTUR  
FAKULTAS TEKNIK SIPIL  
DAN PERENCANAAN  
UNIVERSITAS ISLAM  
INDONESIA

PROYEK AKHIR  
SARJANA



IDENTITAS  
MAHASISWA

Sholli Cholik Rifa,i  
14512168

DOSEN  
PEMBIMBING

Yulia Pratiwi, S.T., M.Eng

NAMA GAMBAR

Perspektif Eksterior

SKALA

KETERANGAN

NO OF PAGE

PAGE

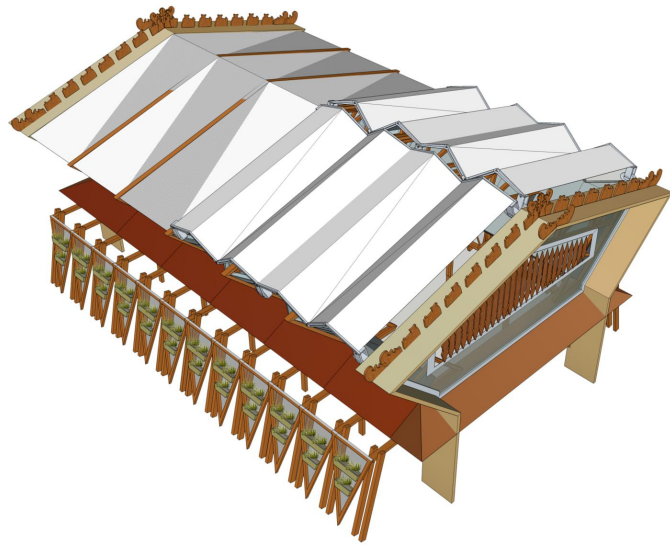

**Movableroof Posisi Tertutup**

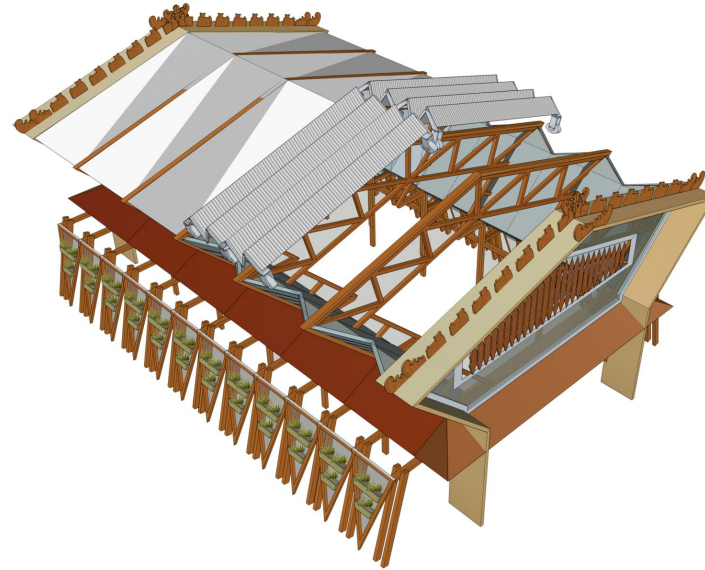

**Movableroof Posisi Terbuka**



**Suasana di Dalam**



JURUSAN ARSITEKTUR  
FAKULTAS TEKNIK SIPIL  
DAN PERENCANAAN  
UNIVERSITAS ISLAM  
INDONESIA

PROYEK AKHIR  
SARJANA



IDENTITAS  
MAHASISWA

Sholli Cholik Rifa,i  
14512168

DOSEN  
PEMBIMBING

Yulia Pratiwi, S.T., M.Eng

NAMA GAMBAR

Movableroof

SKALA

KETERANGAN

NO OF PAGE

PAGE



JURUSAN ARSITEKTUR  
FAKULTAS TEKNIK SIPIL  
DAN PERENCANAAN  
UNIVERSITAS ISLAM  
INDONESIA

PROYEK AKHIR  
SARJANA



IDENTITAS  
MAHASISWA

Sholli Cholik Rifa,i  
14512168

DOSEN  
PEMBIMBING

Yulia Pratiwi, S.T., M.Eng

NAMA GAMBAR

Perspektif Interior

SKALA

KETERANGAN

NO OF PAGE

PAGE

