

**D. ARSITEKTURAL "DINDING"**  
 SCALE - 1 : 50

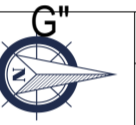

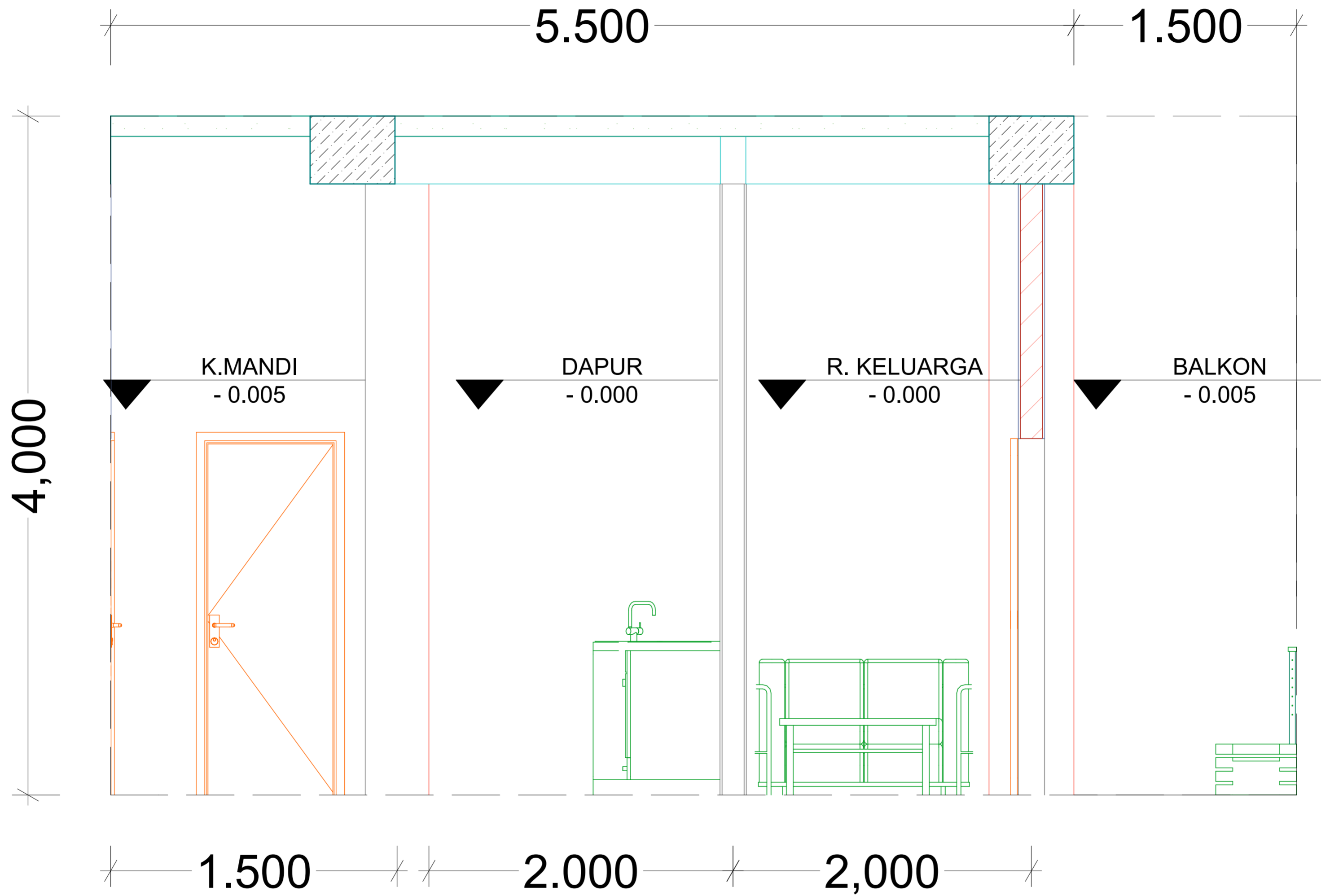

**DETAIL INTERIOR UNIT TYPE A**  
SCALE - 1 : 50

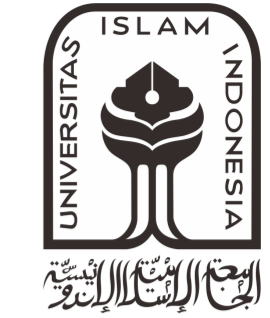

NUMBER OF PAGE	PAGE	LAYOUT ID
		A.01

APPROVED STAMP



**PROJECT NAME**  
 HUNIAN VERTIKAL DAN RETAIL,  
 GAMPINGAN, "RUMAH RAKYAT"  
 YOGYAKARTA



Jalan KH Ahmad Dahlan,  
 Gampingan, Kota Yogyakarta,  
 Daerah Istimewa Yogyakarta  
 Th. 2017/2018

**DRAWING BY**

MUHAMMAD FIQRON NASYWAN

**NIM**

14512178

**APPROVAL**

IR. SUPRIYANTA, M.SI

**DRAWING TITLE**

**DRAWING SUBTITLE**

**PERSPEKTIF EKSTERIOR)**

**DRAWING SCALE**

@A2, @A3  
 1 : 200



**DRAWING STATUS**

DED

**DESCRIPTION**

**PERSPEKTIF EKSTERIOR**

NUMBER OF PAGE	PAGE	LAYOUT ID
		A.01

**APPROVED STAMP**



<b>PROJECT NAME</b> HUNIAN VERTIKAL DAN RETAIL, GAMPINGAN, "RUMAH RAKYAT" YOGYAKARTA	
Jalan KH Ahmad Dahlan, Gampingan, Kota Yogyakarta, Daerah Istimewa Yogyakarta Tn. 2017/2018	

<b>DRAWING BY</b> MUHAMMAD FIQRON NASYWAN
<b>NIM</b> 14512178

<b>APPROVAL</b> IR. SUPRIYANTA, M.SI
-----------------------------------------

<b>DRAWING TITLE</b>
----------------------

<b>DRAWING SUBTITLE</b>
-------------------------

<b>PERSPEKTIF EKSTERIOR)</b>
------------------------------

<b>DRAWING SCALE</b> @A2, @A3 1 : 200		<b>DRAWING STATUS</b> DED
<b>DESCRIPTION</b>		

<b>DESCRIPTION</b>		

NUMBER OF PAGE	PAGE	LAYOUT ID
		A.01

<b>APPROVED STAMP</b>
-----------------------

 **PERSPEKTIF EKSTERIOR**



<b>PROJECT NAME</b> HUNIAN VERTIKAL DAN RETAIL, GAMPINGAN, "RUMAH RAKYAT" YOGYAKARTA	
Jalan KH Ahmad Dahlan, Gampingan, Kota Yogyakarta, Daerah Istimewa Yogyakarta Tn. 2017/2018	

<b>DRAWING BY</b> MUHAMMAD FIQRON NASYWAN
<b>NIM</b> 14512178

<b>APPROVAL</b> IR. SUPRIYANTA, M.SI
-----------------------------------------

<b>DRAWING TITLE</b>
----------------------

<b>DRAWING SUBTITLE</b>
-------------------------

**PERSPEKTIF EKSTERIOR)**

<b>DRAWING SCALE</b> @A2, @A3 1 : 200		<b>DRAWING STATUS</b> DED
---------------------------------------------	--	------------------------------

**DESCRIPTION**

NUMBER OF PAGE	PAGE	LAYOUT ID
		A.01

**APPROVED STAMP**

# PERSPEKTIF EKSTERIOR

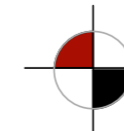

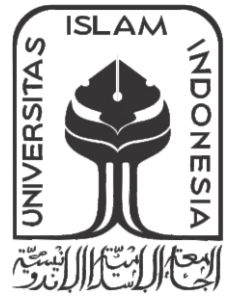

**PROJECT NAME**

HUNIAN VERTIKAL DAN RETAIL,  
 GAMPINGAN, "RUMAH RAKYAT"  
 YOGYAKARTA

Jalan KH Ahmad Dahlan,  
 Gampingan, Kota Yogyakarta,  
 Daerah Istimewa Yogyakarta  
 Th. 2017/2018



**DRAWING BY**

MUHAMMAD FIQRON NASYWAN

**NIM**

14512178

**APPROVAL**

IR. SUPRIYANTA, M.SI

**DRAWING TITLE**

**DRAWING SUBTITLE**

**PERSPEKTIF INTERIOR**

**DRAWING SCALE**

@A2, @A3  
 1 : 200

**DRAWING STATUS**

DED

**DESCRIPTION**

NUMBER OF PAGE	PAGE	LAYOUT ID
		A.01

**APPROVED STAMP**

**PERSPEKTIF INTERIOR**

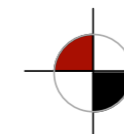



## PERSPEKTIF INTERIOR

PROJEK AKHIR SARJANA

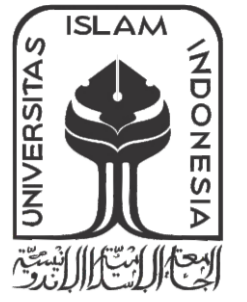

UNIVERSITAS ISLAM INDONESIA

JL. KALIURANG KM 14.5, KAB. SLEMAN,  
DAERAH ISTIMEWA YOGYAKARTA

PROJECT NAME

HUNIAN VERTIKAL DAN RETAIL,  
GAMPINGAN, "RUMAH RAKYAT"  
YOGYAKARTA

Jalan KH Ahmad Dahlan,  
Gampingan, Kota Yogyakarta,  
Daerah Istimewa Yogyakarta  
Tn. 2017/2018



DRAWING BY

MUHAMMAD FIQRON NASYWAN

NIM

14512178

APPROVAL

IR. SUPRIYANTA, M.SI

DRAWING TITLE

DRAWING SUBTITLE

PERSPEKTIF INTERIOR

DRAWING SCALE

@A2, @A3  
1 : 200



DRAWING STATUS

DED

DESCRIPTION

NUMBER OF PAGE

PAGE

LAYOUT ID

A.01

APPROVED STAMP



<b>PROJECT NAME</b> HUNIAN VERTIKAL DAN RETAIL, GAMPINGAN, "RUMAH RAKYAT" YOGYAKARTA Jalan KH Ahmad Dahlan, Gampingan, Kota Yogyakarta, Daerah Istimewa Yogyakarta Tn. 2017/2018	
-------------------------------------------------------------------------------------------------------------------------------------------------------------------------------------------------------	-------------------------------------------------------------------------------------

**DRAWING BY**

MUHAMMAD FIQRON NASYWAN

**NIM**

14512178

**APPROVAL**

IR. SUPRIYANTA, M.SI

**DRAWING TITLE**

**DRAWING SUBTITLE**

**PERSPEKTIF INTERIOR**

**DRAWING SCALE**

@A2, @A3  
1 : 200



**DRAWING STATUS**

DED

**DESCRIPTION**

**NUMBER OF PAGE**

**PAGE**

**LAYOUT ID**

A.01

**APPROVED STAMP**

**PERSPEKTIF INTERIOR**

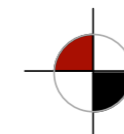





<b>PROJECT NAME</b> HUNIAN VERTIKAL DAN RETAIL, GAMPINGAN, "RUMAH RAKYAT" YOGYAKARTA	
Jalan KH Ahmad Dahlan, Gampingan, Kota Yogyakarta, Daerah Istimewa Yogyakarta Tn. 2017/2018	

<b>DRAWING BY</b> MUHAMMAD FIQRON NASYWAN
----------------------------------------------

<b>NIM</b> 14512178
------------------------

<b>APPROVAL</b> IR. SUPRIYANTA, M.SI
-----------------------------------------

<b>DRAWING TITLE</b>	
----------------------	--

<b>DRAWING SUBTITLE</b>
-------------------------

<b>SITUASI</b>
----------------

<b>DRAWING SCALE</b> @A2, @A3 1 : 200		<b>DRAWING STATUS</b> DED
---------------------------------------------	--	------------------------------

<b>DESCRIPTION</b>
--------------------

<b>NUMBER OF PAGE</b>	<b>PAGE</b>	<b>LAYOUT ID</b>
		A.01

<b>APPROVED STAMP</b>
-----------------------



**SITUASI**

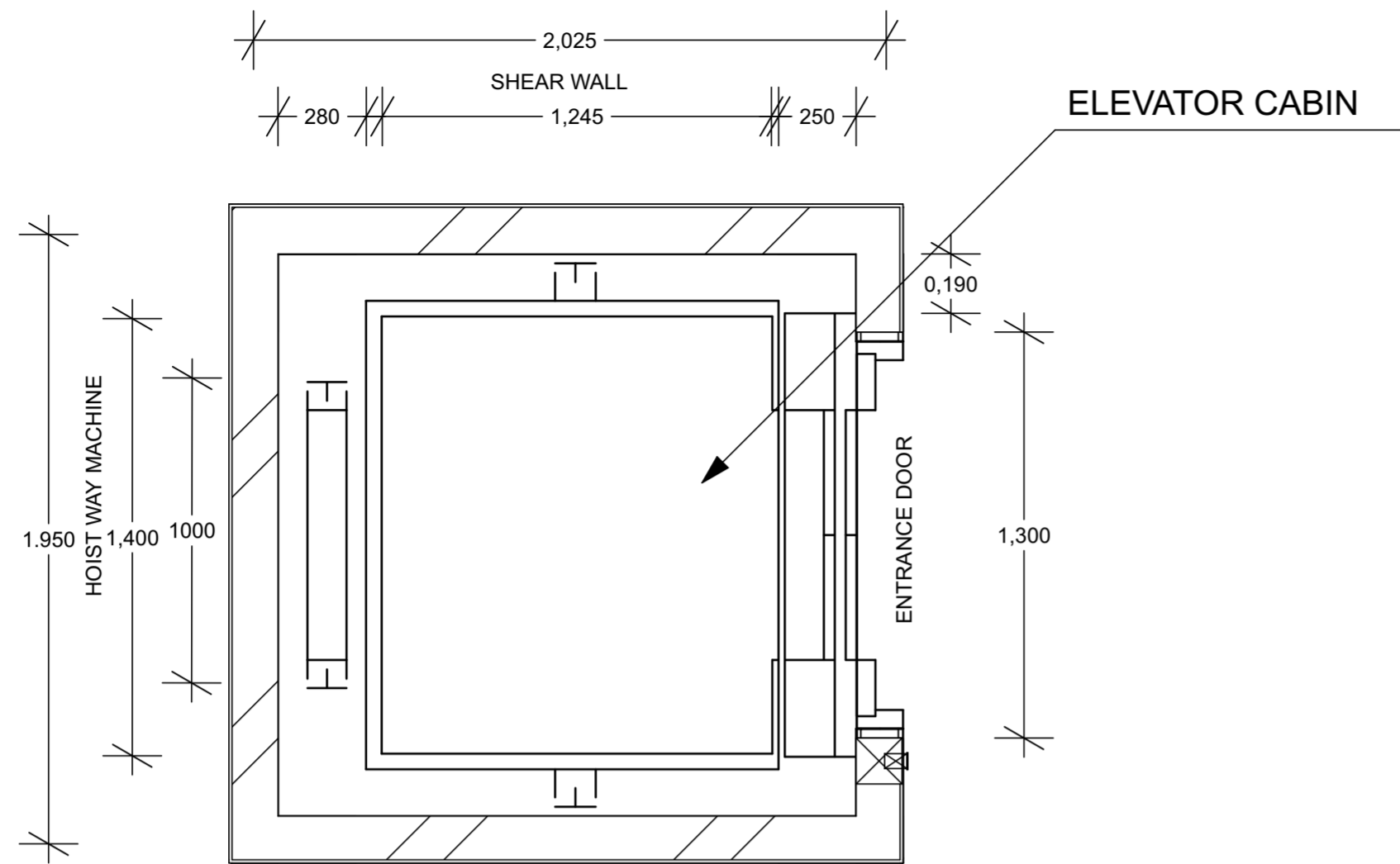

PASSENGER ELEVATOR PLAN  
SCALE 1:20

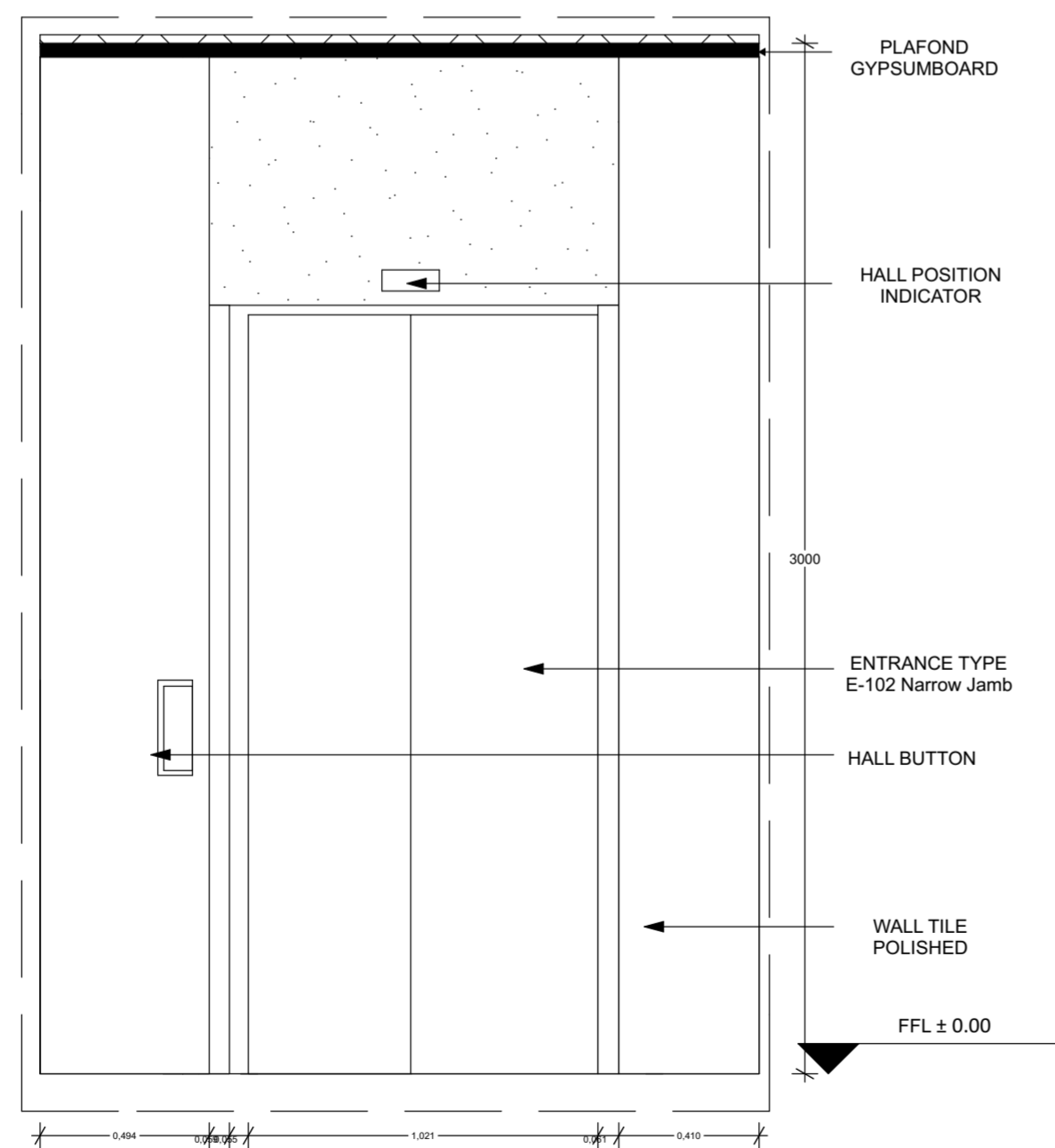

PASSANGER ELEVATOR ELEVATION

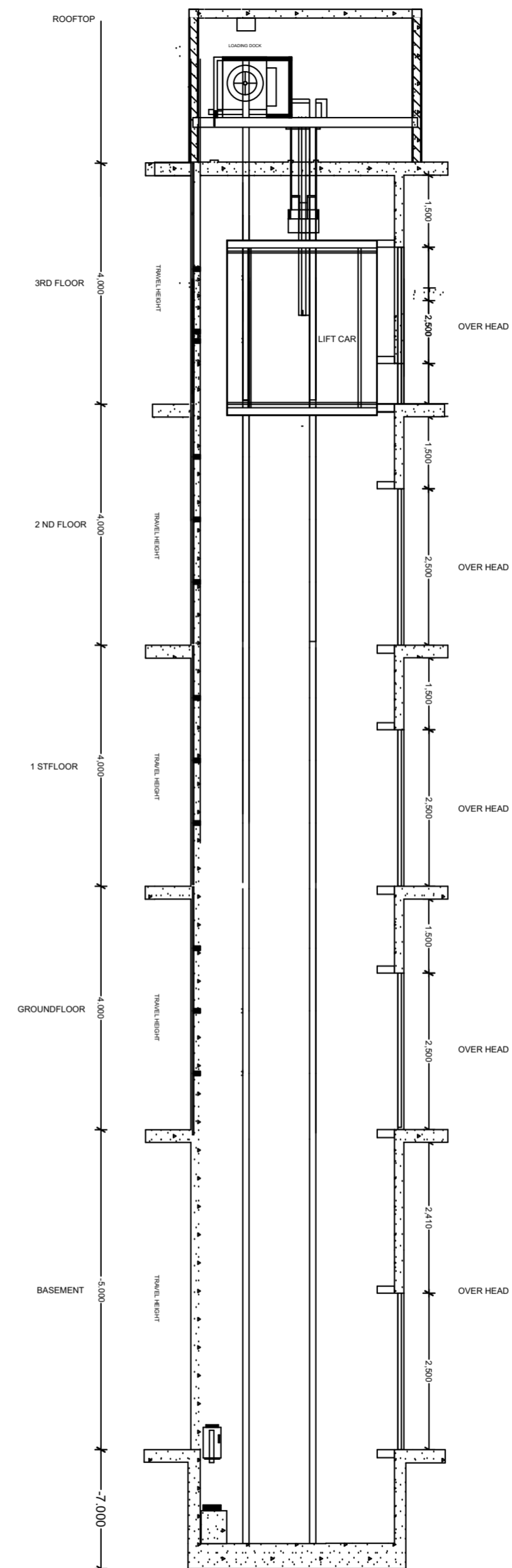

SKEMA TRASPORTASI VERTIKAL (LIFT)

SCALE - 1 : 20, 1 : 100



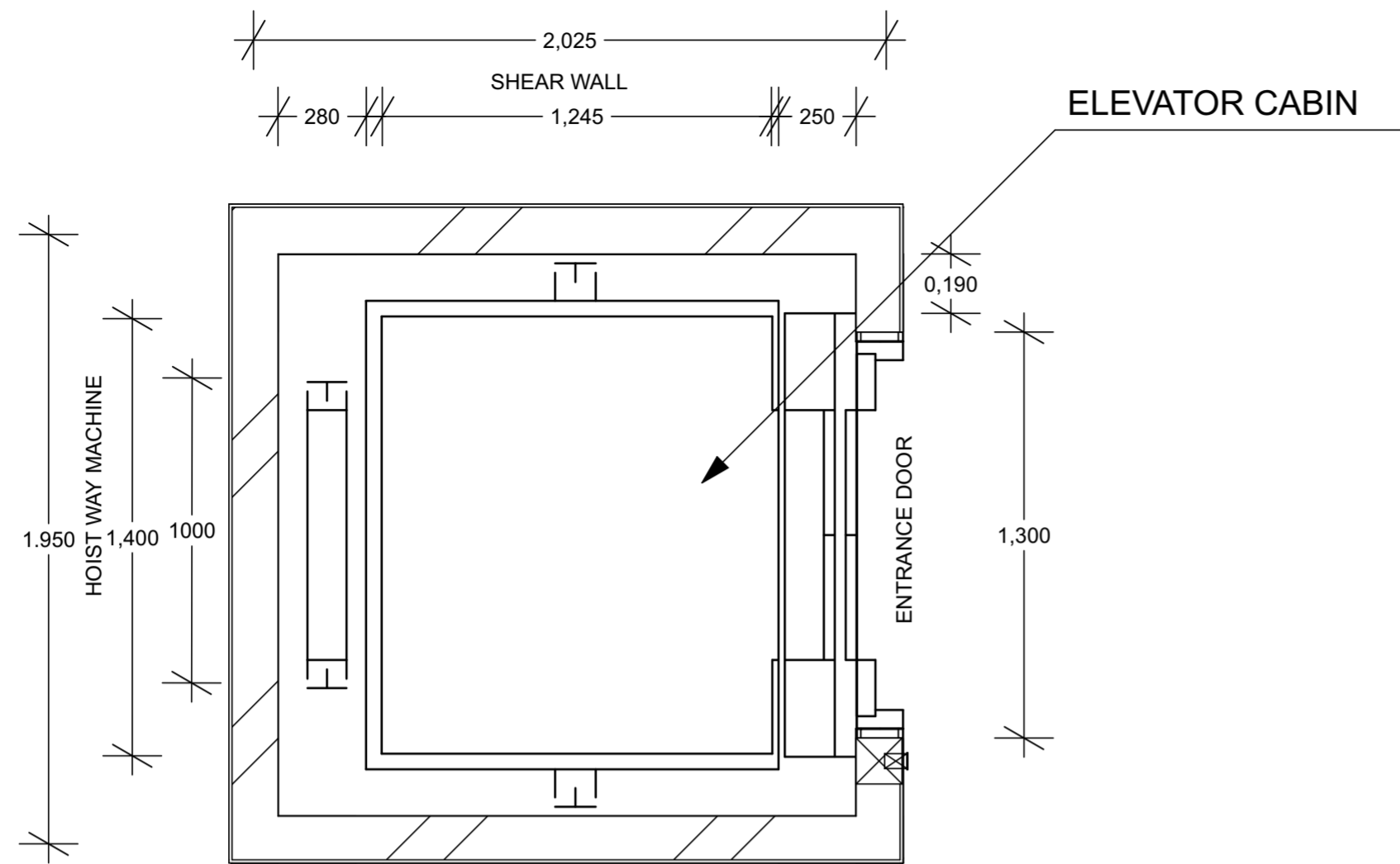

PASSENGER ELEVATOR PLAN  
SCALE 1:20

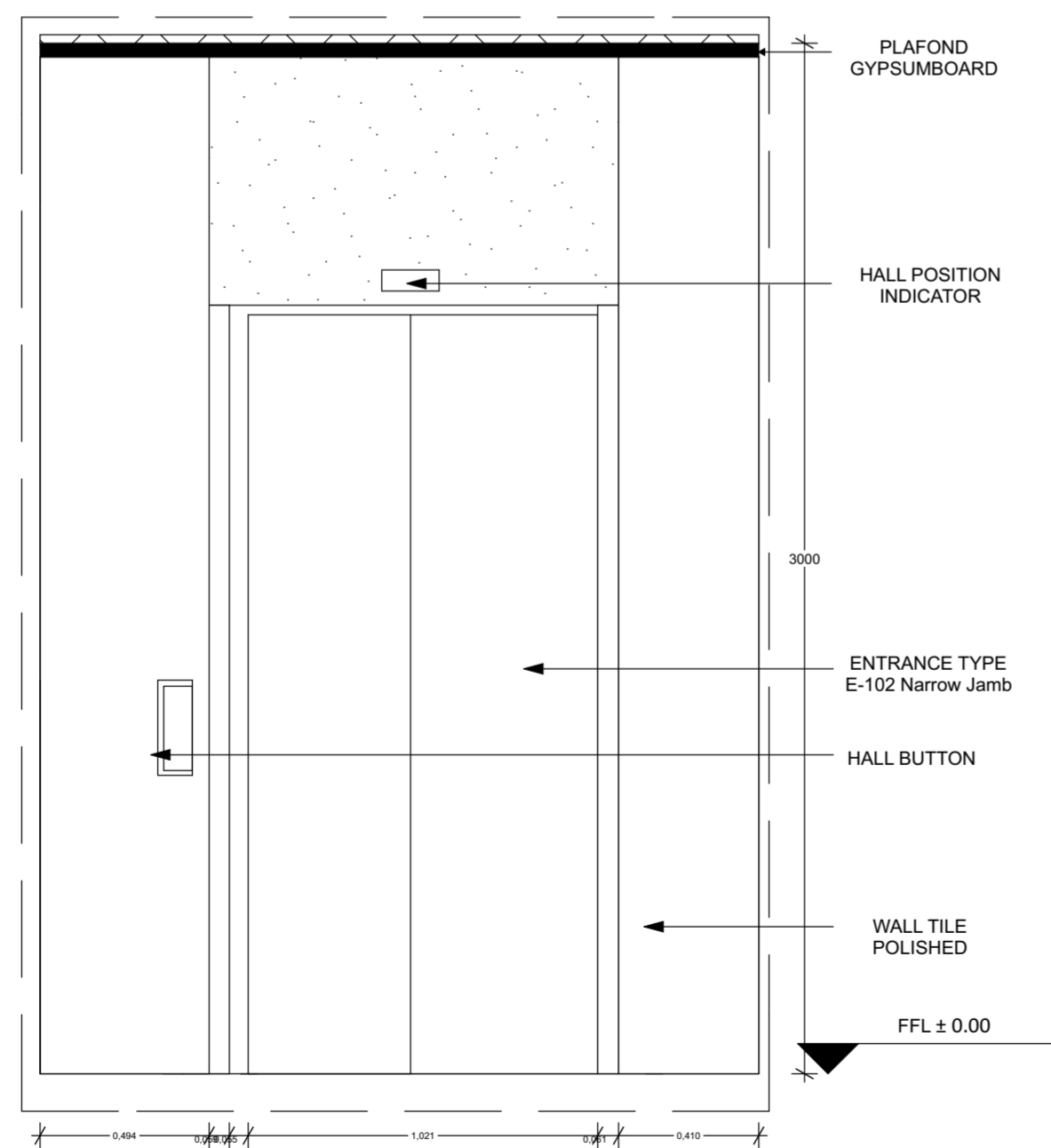

PASSANGER ELEVATOR ELEVATION

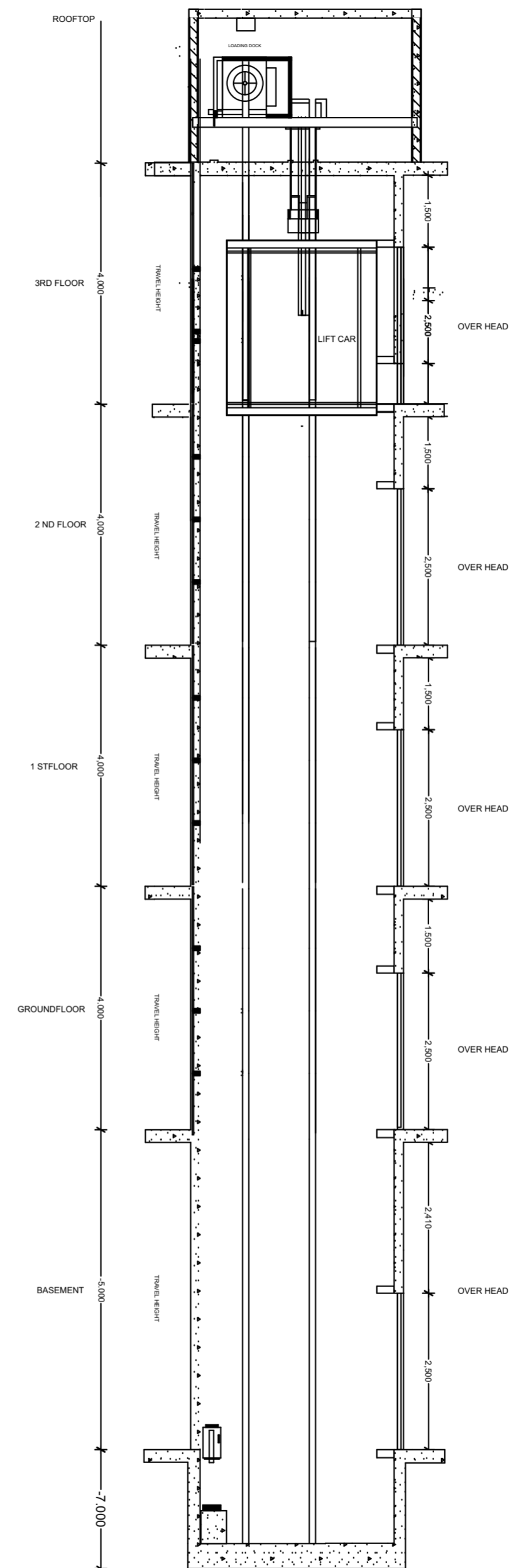

SKEMA TRASPORTASI VERTIKAL (LIFT)

SCALE - 1 : 20, 1 : 100



PROJECT NAME

HUNIAN VERTIKAL DAN RETAIL,  
GAMPINGAN, "RUMAH RAKYAT"  
YOGYAKARTA

Jalan KH Ahmad Dahlan,  
Gampingan, Kota Yogyakarta,  
Daerah Istimewa Yogyakarta  
Tn. 2017/2018



DRAWING BY

MUHAMMAD FIQRON NASYWAN

NIM

14512178

APPROVAL

IR. SUPRIYANTA, M.SI

DRAWING TITLE

RANCANGAN  
SKEMATIK

DRAWING SUBTITLE

SKEMA TRASPORTASI  
VERTIKAL (LIFT)

DRAWING SCALE

@A2, @A3  
1 : 200

DRAWING STATUS

DED

DESCRIPTION

NUMBER OF PAGE	PAGE	LAYOUT ID
		A.01

APPROVED STAMP



NUMBER OF PAGE	PAGE	LAYOUT ID
		A.01

**APPROVED STAMP**

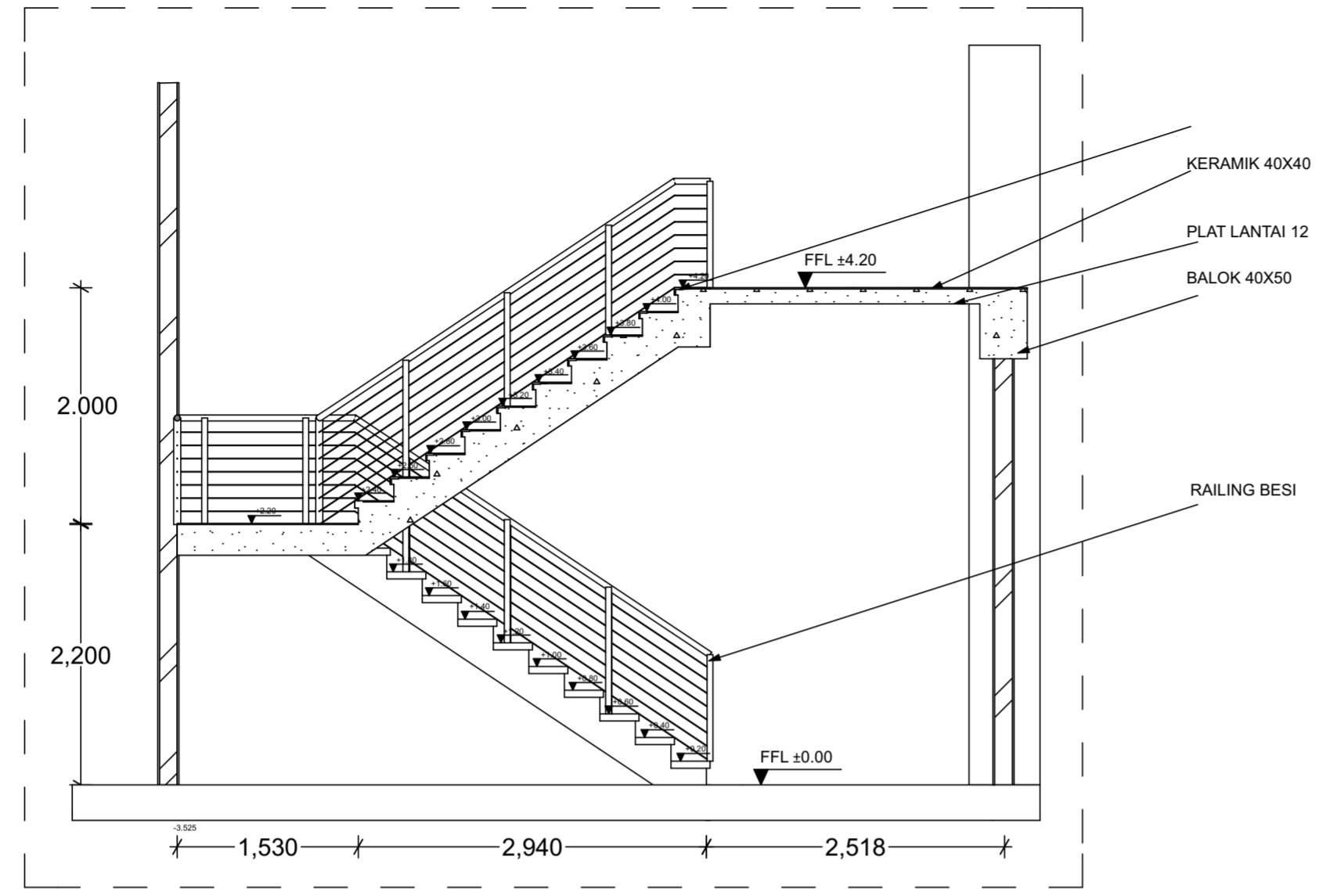

**MAIN STAIRS SECTION**  
 SCALE 1:50

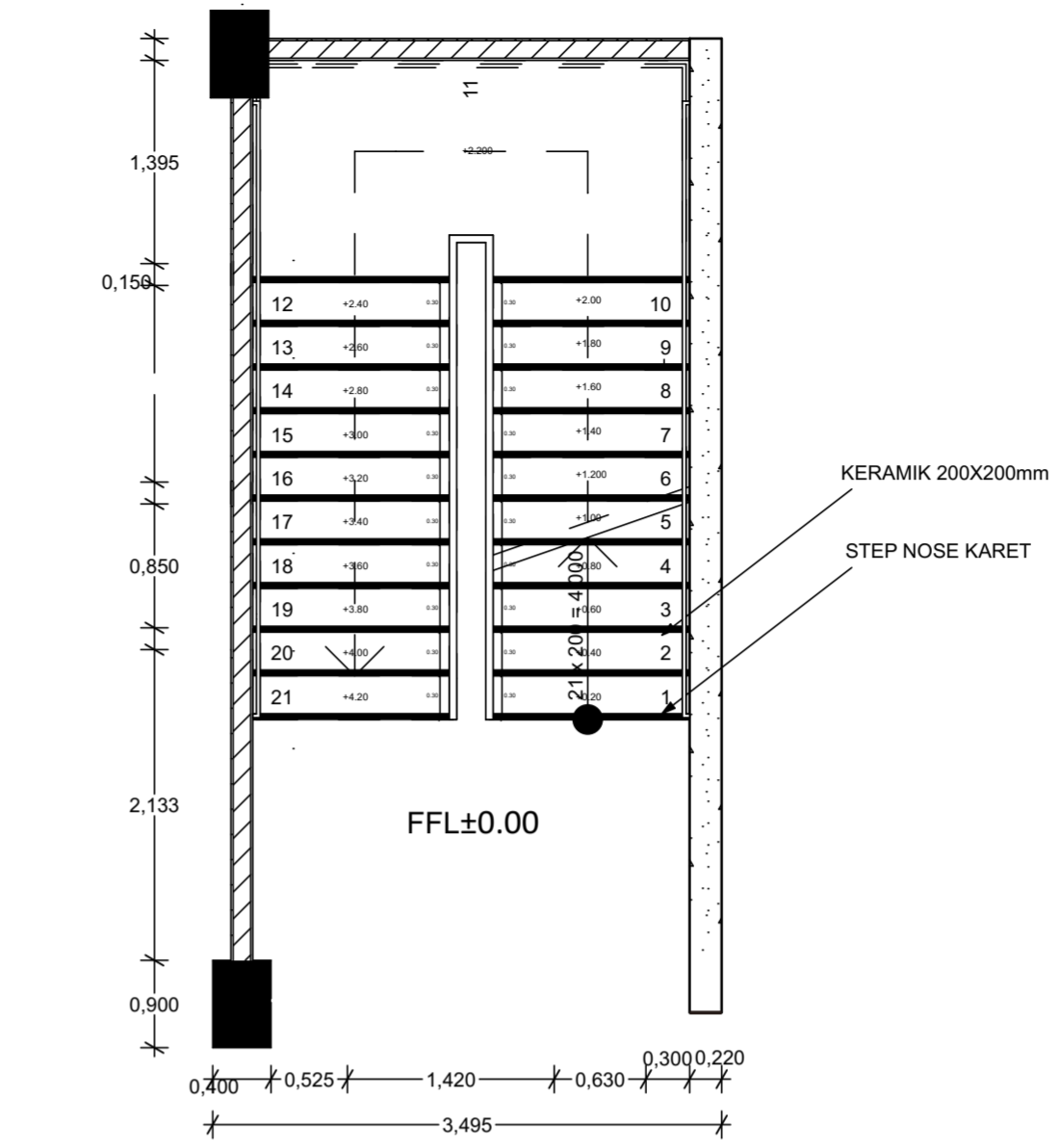

**MAIN STAIRS PLAN**  
 SCALE 1:50

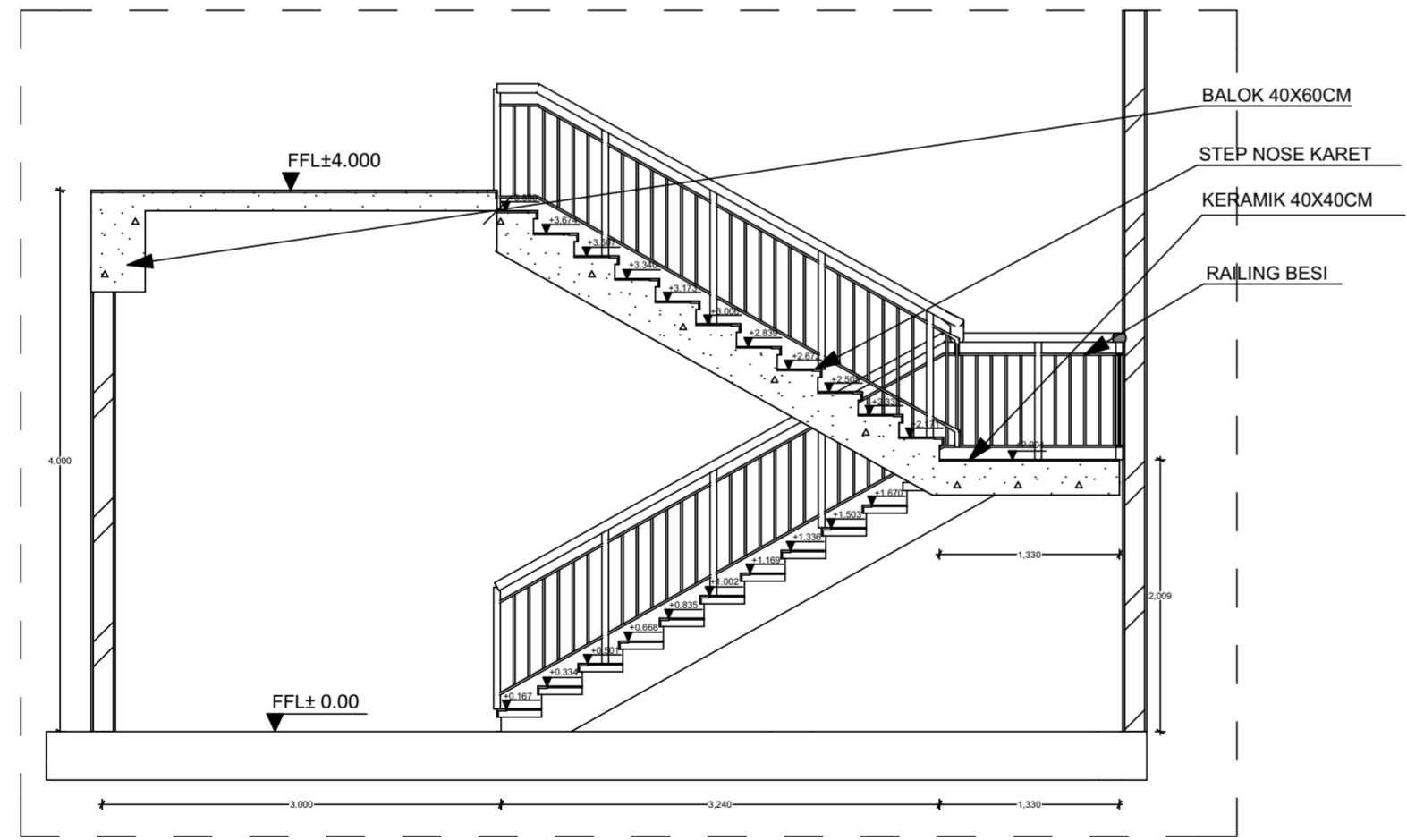

**EMERGENCY STAIRS SECTION**  
 SCALE 1:50

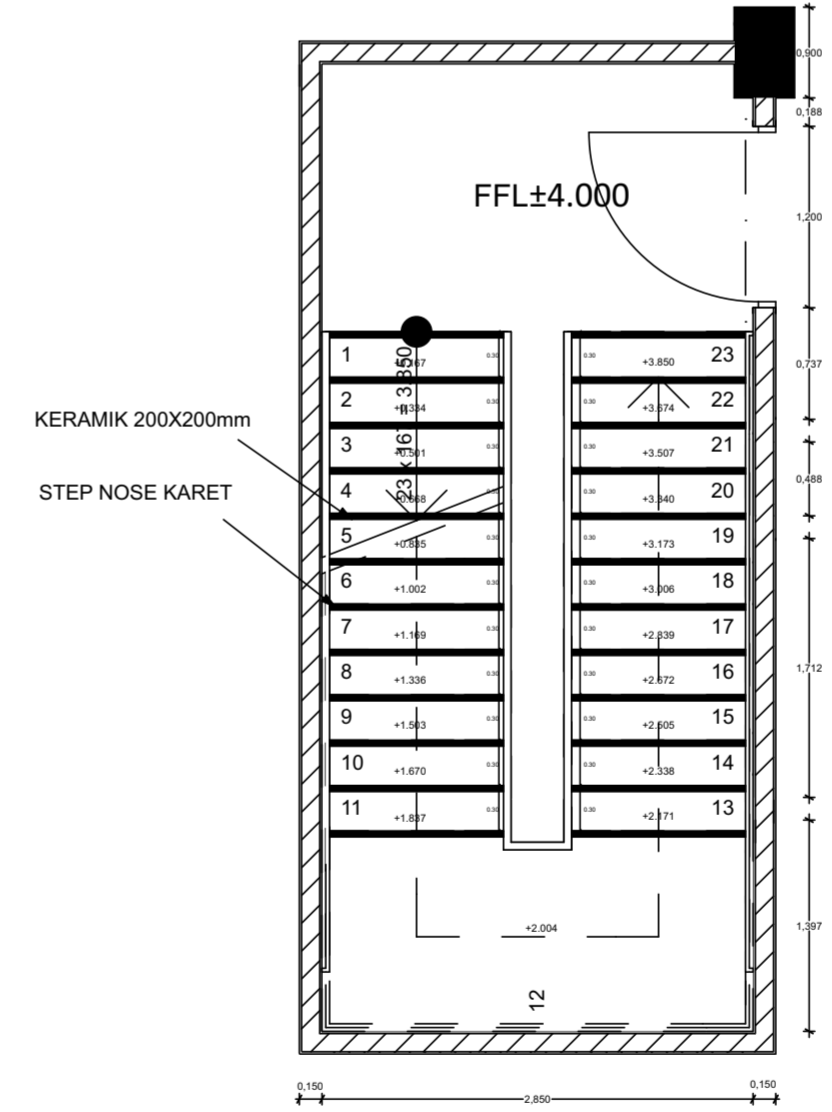

**EMERGENCY STAIRS**  
 SCALE 1:50

**SKEMA TRASPORTASI VERTIKAL (STAIR)**  
 SCALE - 1 : 50

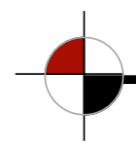



PROJECT NAME

HUNIAN VERTIKAL DAN RETAIL,  
 GAMPINGAN, "RUMAH RAKYAT"  
 YOGYAKARTA



Jalan KH Ahmad Dahlan,  
 Gampingan, Kota Yogyakarta,  
 Daerah Istimewa Yogyakarta  
 Th. 2017/2018

DRAWING BY

MUHAMMAD FIQRON NASYWAN

NIM

14512178

APPROVAL

IR. SUPRIYANTA, M.SI

DRAWING TITLE

STRUKTURAL RS-04

DRAWING SUBTITLE

GROUND FLOOR BEAM PLAN

DRAWING SCALE

@A2, @A3  
 1 : 200



DRAWING STATUS

DED

DESCRIPTION

BEAM CODE(S) :  
 - B1 = 400 x 400  
 - B2 = 150 x 150

NUMBER OF PAGE

PAGE

LAYOUT ID

A.02

APPROVED STAMP

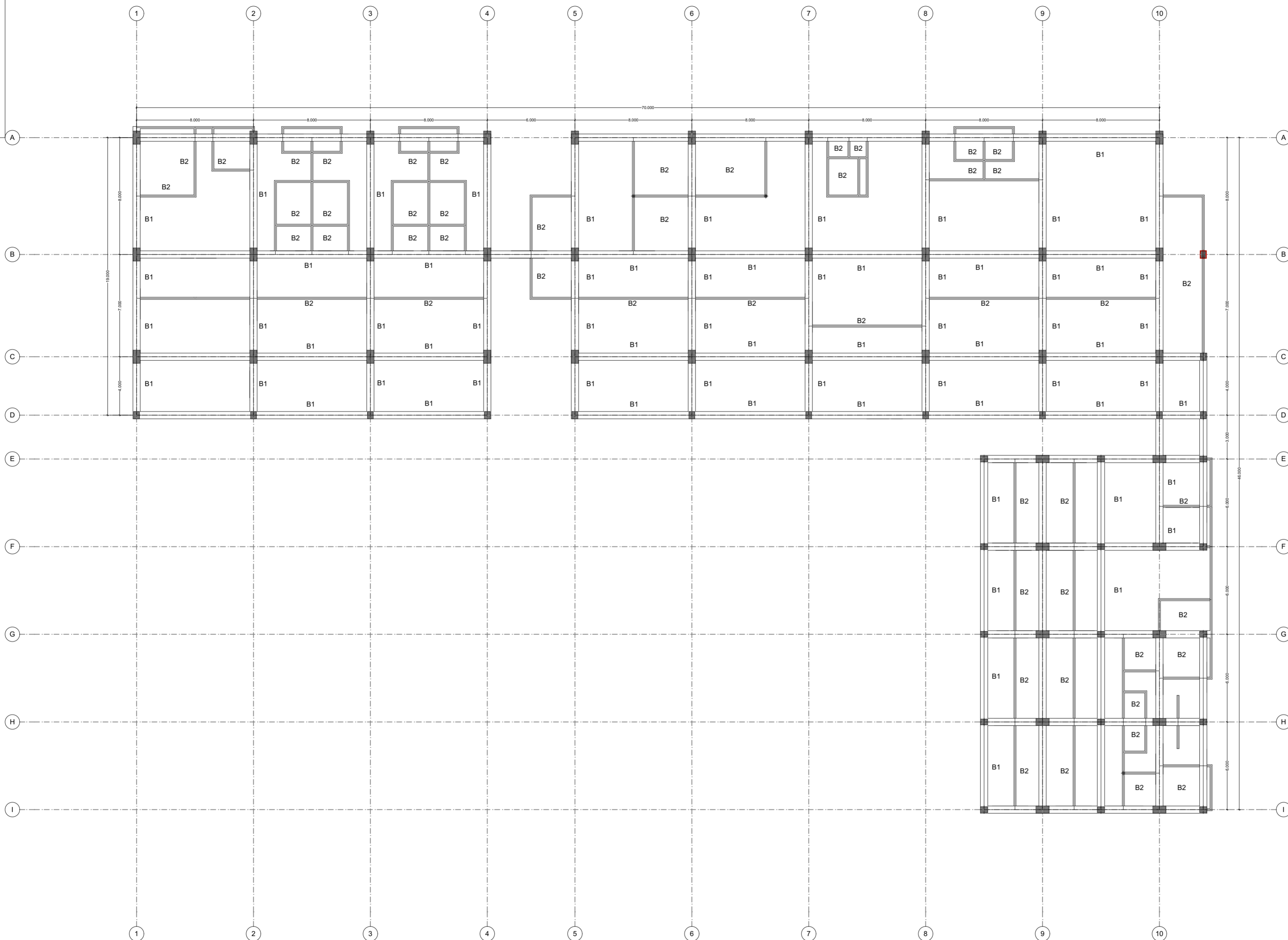

GROUND FLOOR BEAM PLAN

SCALE - 1 : 200

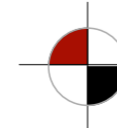

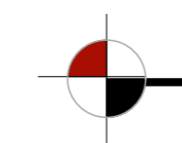
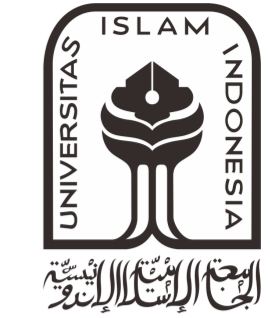
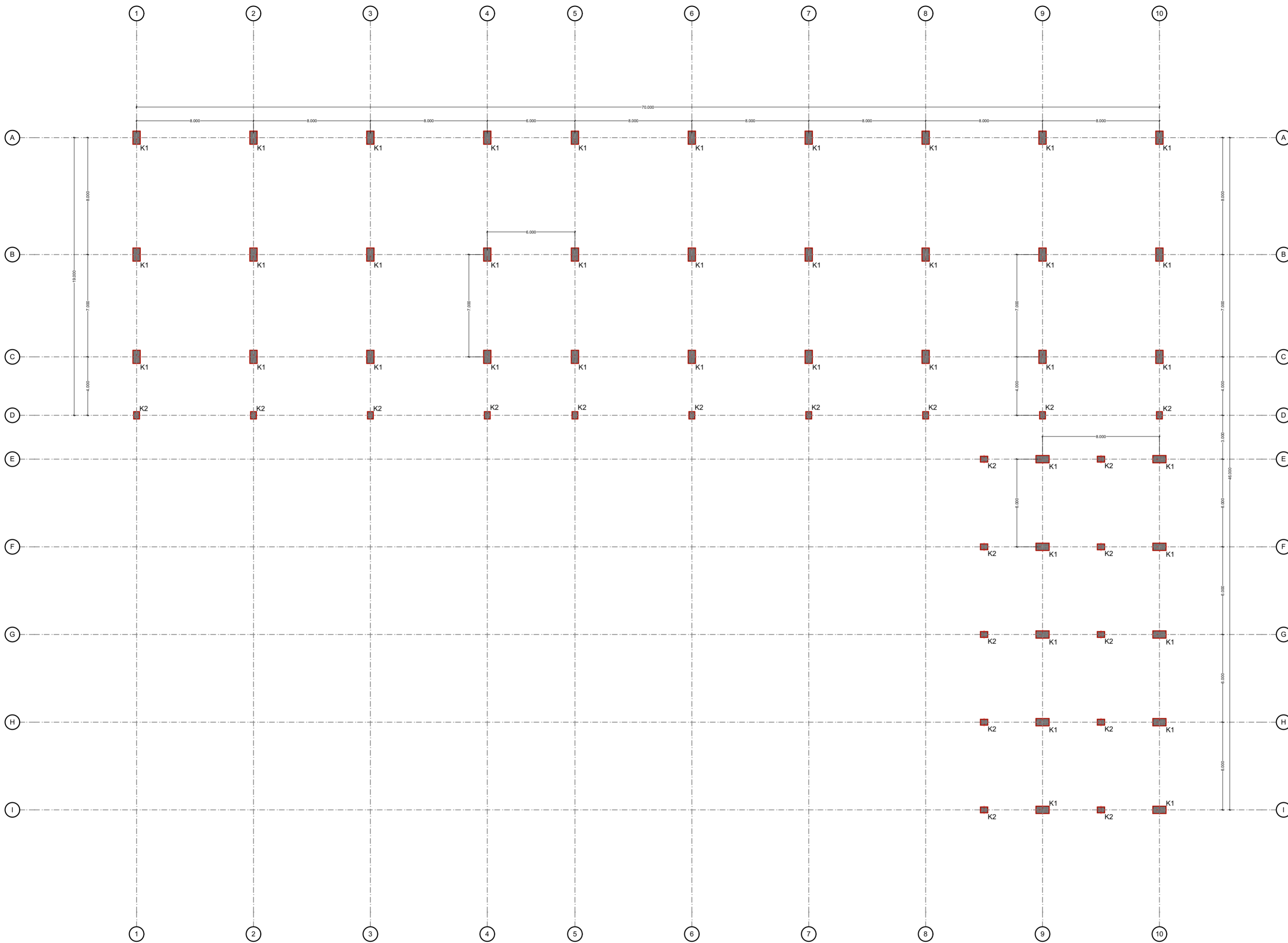

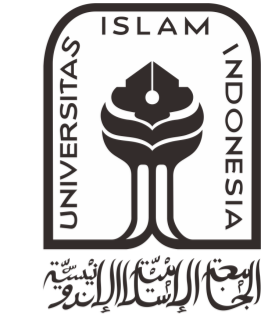

BEAM CODE(S) :  
 - B1 = 400 x 400  
 - B2 = 150 x 150

NUMBER OF PAGE	PAGE	LAYOUT ID
		A.01

APPROVED STAMP

TYPICAL FLOOR BEAM PLAN  
 SCALE - 1 : 200



PROJECT NAME

HUNIAN VERTIKAL DAN RETAIL,  
 GAMPINGAN, "RUMAH RAKYAT"  
 YOGYAKARTA

Jalan KH Ahmad Dahlan,  
 Gampingan, Kota Yogyakarta,  
 Daerah Istimewa Yogyakarta  
 Th. 2017/2018



DRAWING BY

MUHAMMAD FIQRON NASYWAN

NIM

14512178

APPROVAL

IR. SUPRIYANTA, M.SI

DRAWING TITLE

STRUKTURAL RS-02

DRAWING SUBTITLE

TYPICAL FLOOR COLUMN PLAN

DRAWING SCALE

@A2, @A3  
 1 : 200



DRAWING STATUS

DED

DESCRIPTION

COLUMN CODE(S) :  
 - K1 = 400 x 900  
 - K2 = 400 x 500

NUMBER OF PAGE

PAGE

LAYOUT ID

A.04

APPROVED STAMP

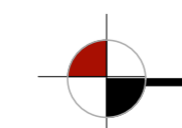
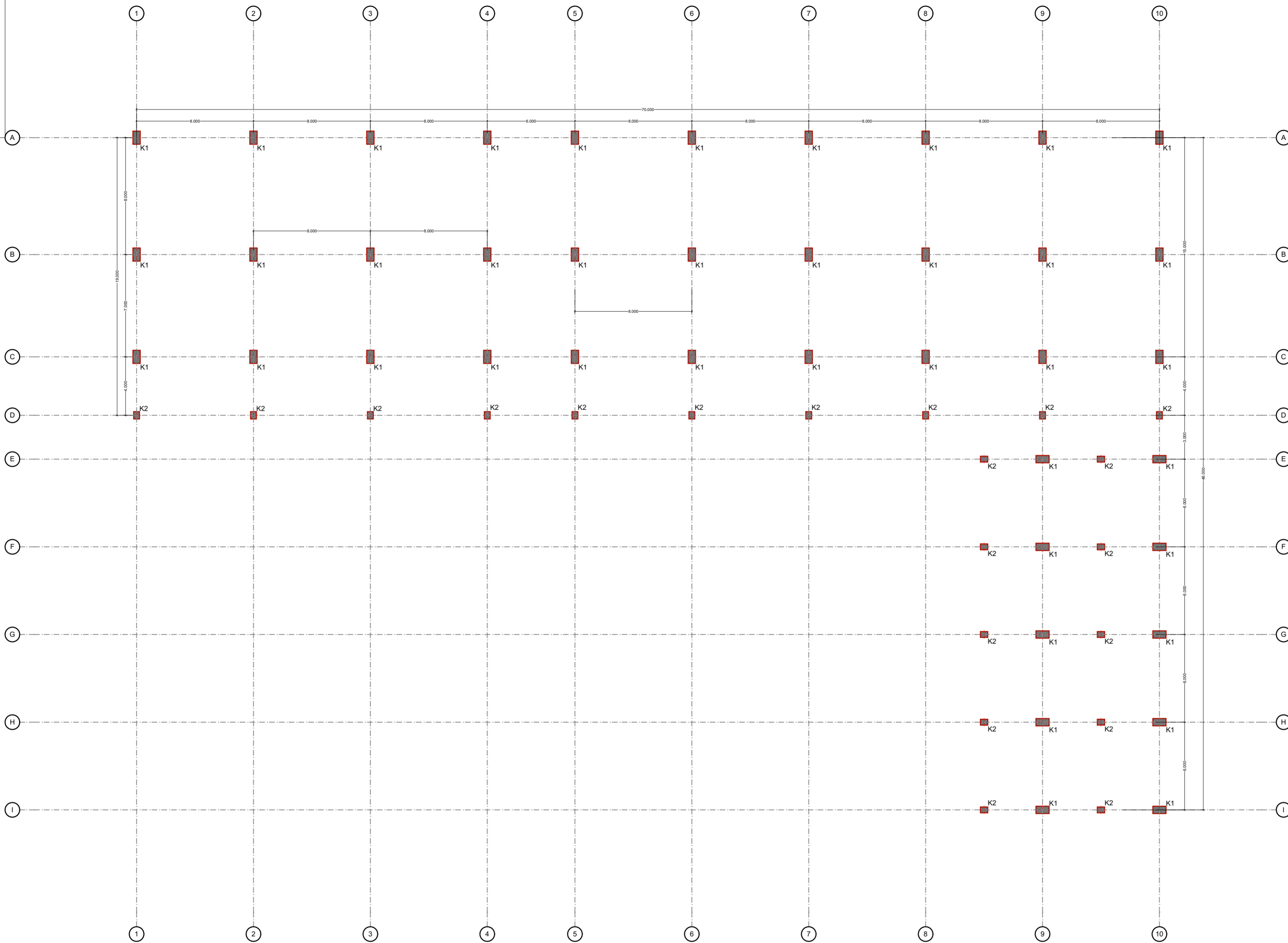

TYPICAL FLOOR COLUMN PLAN

SCALE - 1 : 200



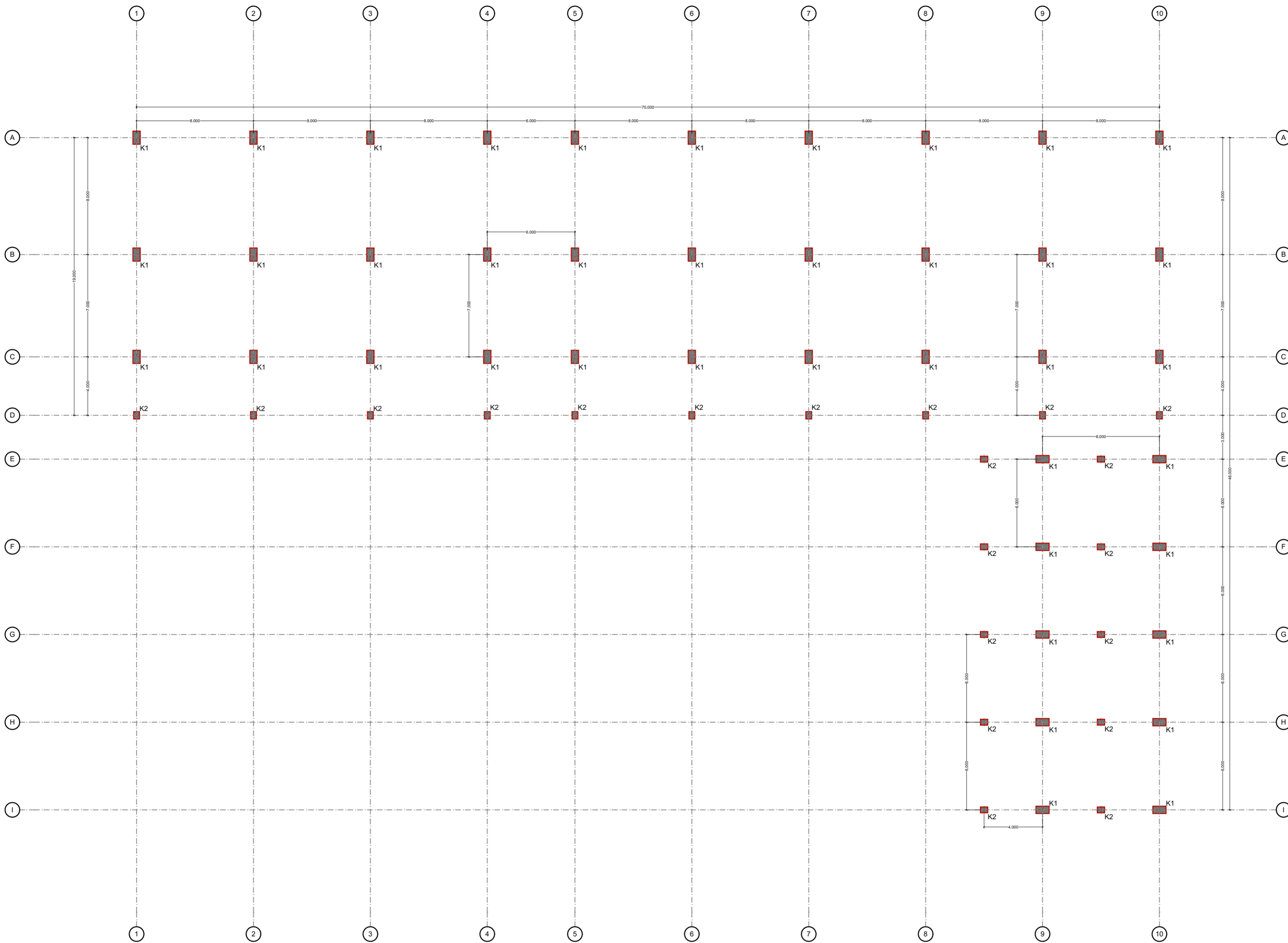

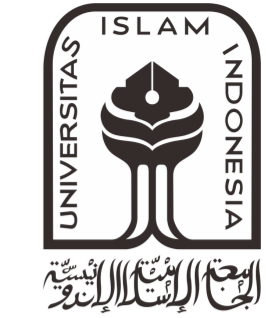

**BASEMENT COLUMN PLAN**  
**SCALE - 1 : 200**

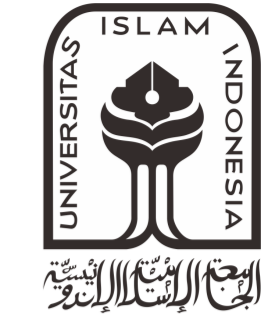
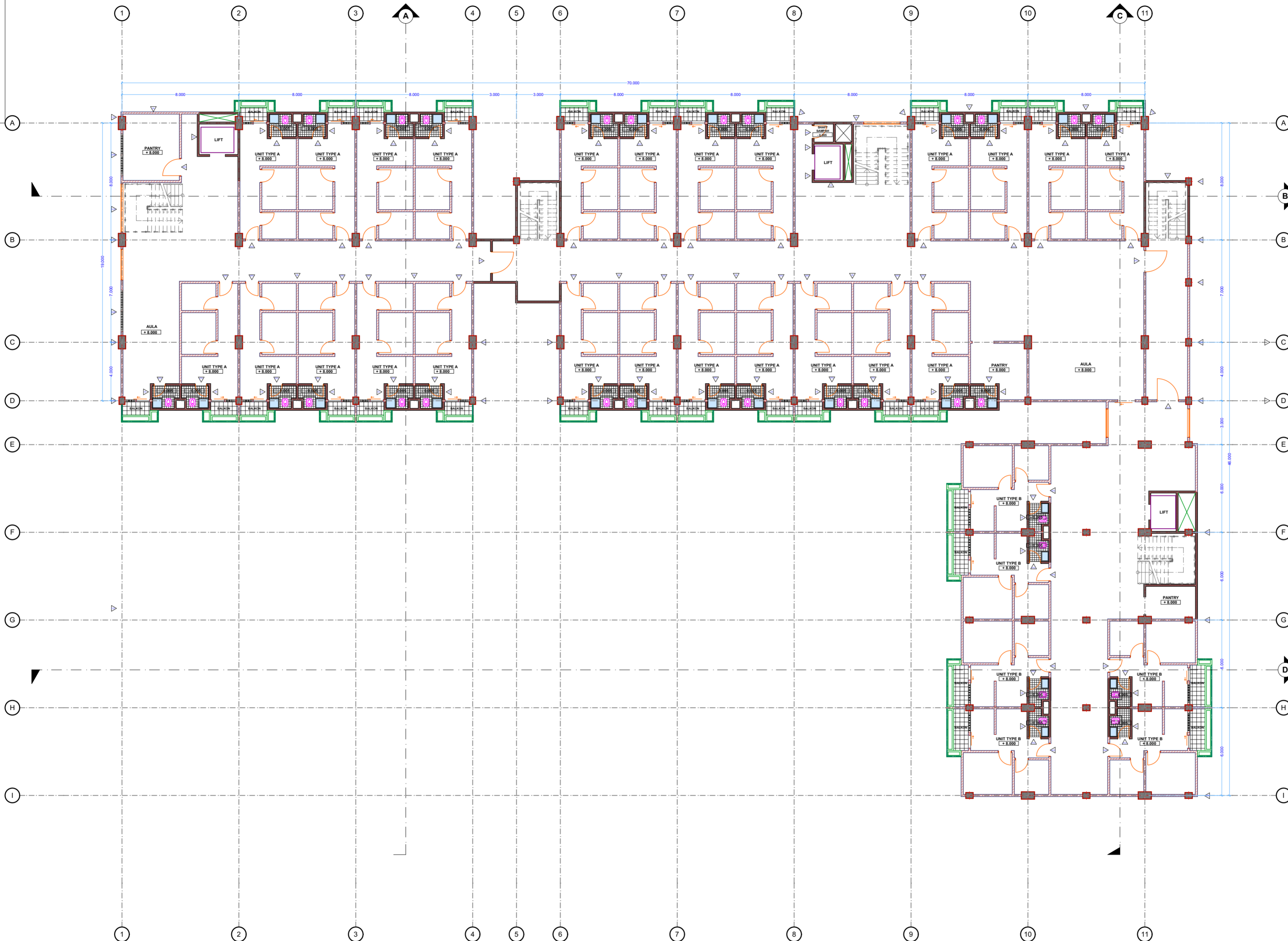

NUMBER OF PAGE	PAGE	LAYOUT ID
		A.03

**APPROVED STAMP**



DESCRIPTION

BE	BRICKWALL PLASTERED & PAINTED W/ ACRYLIC EMULSION PAINT
CE	CONCRETEWALL PLASTERED & PAINTED W/ WATERPROOF PAINT
CCE	CONCRETE COLUMN PLASTERED & PAINTED W/ ACRYLIC EMULSION PAINT
HPD	HONEYCOMB PVC WOODEN DOOR w/ PVC WOOD FRAME & DOUBLE HMR PVC FINISHING
PFD	PVC TOILET DOOR w/ PVC SOLID COLOR FINISHING
FLD	FRAMELESS DOOR w/ 12mm TEMPERED TINTED GLASS
SFD	SINGLE STEEL FIRE DOOR w/ STEEL 2MM FRAME ROCKWOOL & FINISHING DUCO PAINT BRASS
ACW	ALUMINIUM POWDER COATING CASEMENT WINDOW (WHITE COLOR) w/ 5mm TINTED GLASS
ASD	ALUMINIUM POWDER COATING SLIDING WINDOW (WHITE COLOR) w/ 5mm TINTED GLASS
CW	CURTAIN WALL w/ 12mm TEMPERED TINTED GLASS
BWB	BRICKWALL W/ BOTTLE PARTITION
CBW	CONCRETE BASEMENTWALL W/ SOLID COLOR FINISHING
SD	STEEL DOOR W/ STEEL FRAME (WHITE COLOR) "PINTU ANGKAT"

EXCLUDED:  
 -FLOOR FINISHING  
 -RAILING  
 -STAIR CASE

NUMBER OF PAGE	PAGE	LAYOUT ID
		A.08

APPROVED STAMP

DENAH LANTAI 2 - TYPICAL

SCALE - 1 : 200

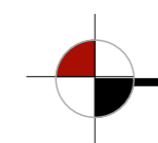

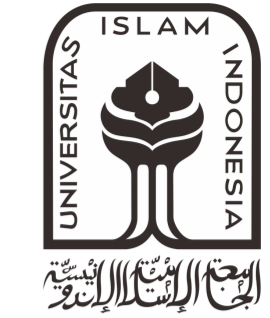
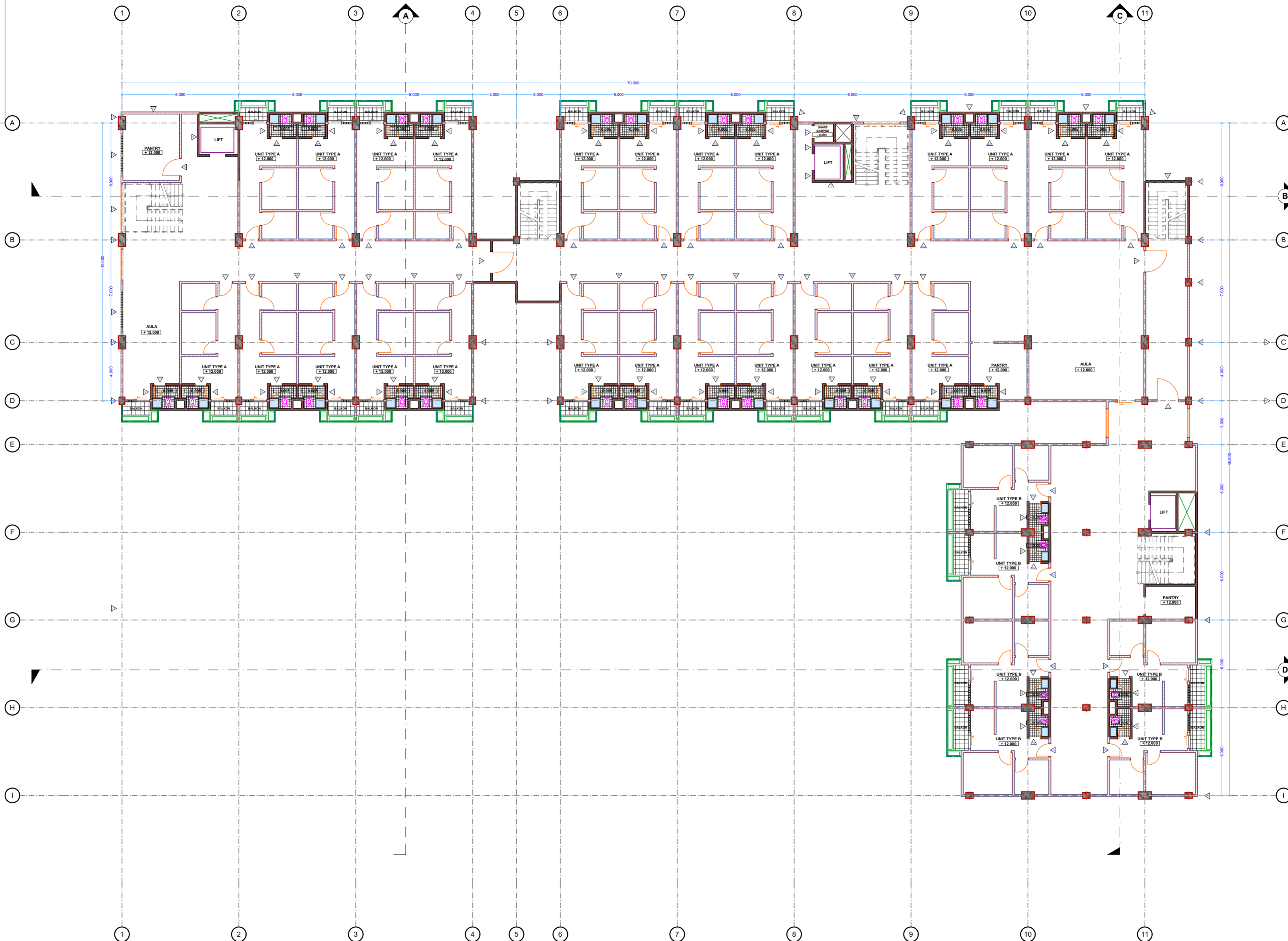

DESCRIPTION

BE	BRICKWALL PLASTERED & PAINTED W/ ACRYLIC EMULSION PAINT
CE	CONCRETEWALL PLASTERED & PAINTED W/ WATERPROOF PAINT
CCE	CONCRETE COLUMN PLASTERED & PAINTED W/ ACRYLIC EMULSION PAINT
HPD	HONEYCOMB PVC WOODEN DOOR w/ PVC WOOD FRAME & DOUBLE HMR PVC FINISHING
PFD	PVC TOILET DOOR w/ PVC SOLID COLOR FINISHING
FLD	FRAMELESS DOOR w/ 12mm TEMPERED TINTED GLASS
SFD	SINGLE STEEL FIRE DOOR w/ STEEL 2MM FRAME ROCKWOOL & FINISHING DUCO PAINT BRASS
ACW	ALUMINIUM POWDER COATING CASEMENT WINDOW (WHITE COLOR) w/ 5mm TINTED GLASS
ASD	ALUMINIUM POWDER COATING SLIDING WINDOW (WHITE COLOR) w/ 5mm TINTED GLASS
CW	CURTAIN WALL w/ 12mm TEMPERED TINTED GLASS
BWB	BRICKWALL W/ BOTTLE PARTITION
CBW	CONCRETE BASEMENTWALL W/ SOLID COLOR FINISHING
SD	STEEL DOOR W/ STEEL FRAME (WHITE COLOR) "PINTU ANGKAT"

EXCLUDED:  
 -FLOOR FINISHING  
 -RAILING  
 -STAIR CASE

NUMBER OF PAGE	PAGE	LAYOUT ID
		A.07

APPROVED STAMP

DENAH LANTAI 3 - TYPICAL

SCALE - 1 : 200

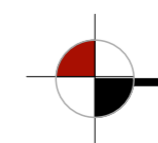

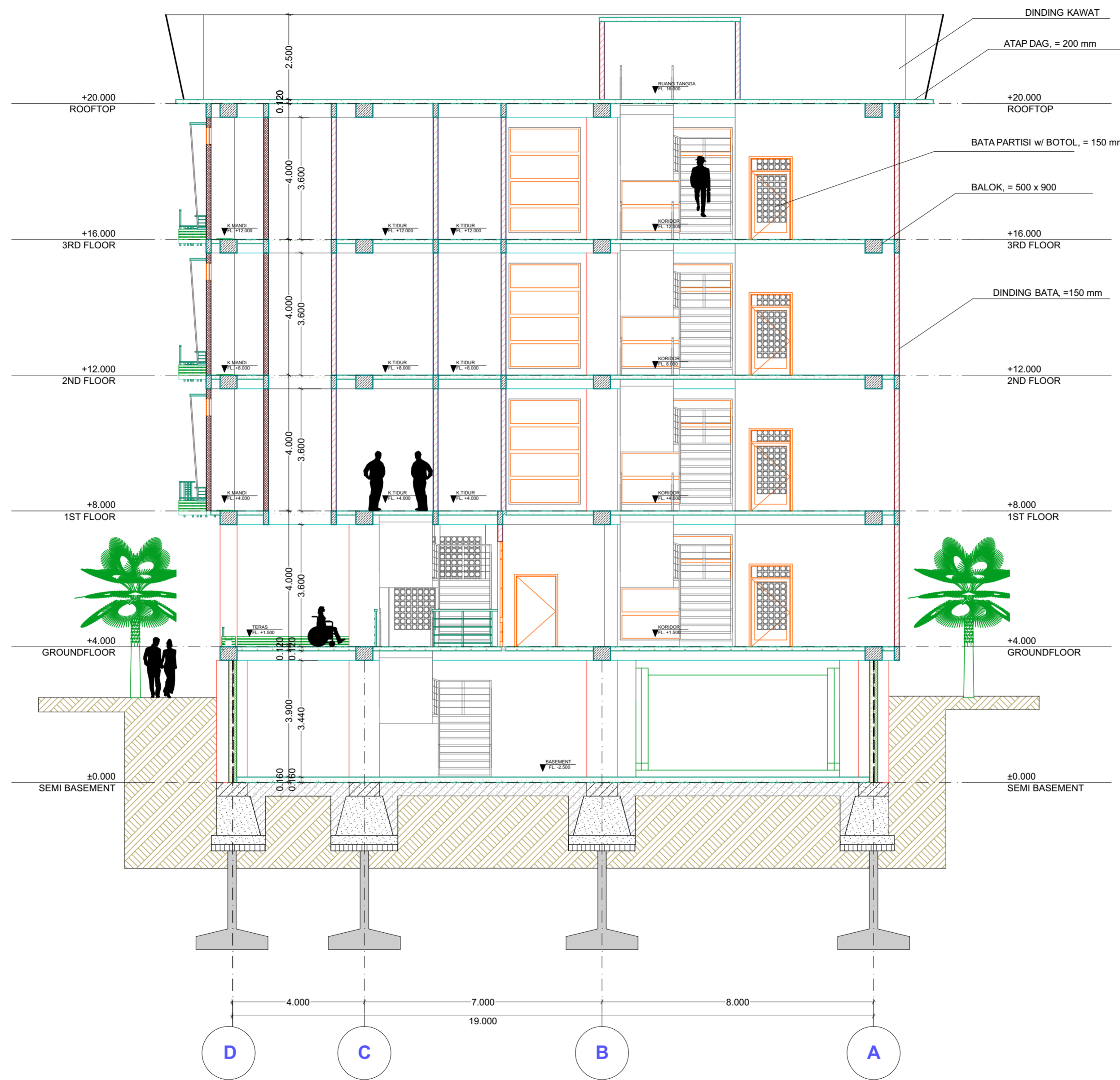

POTONGAN A - A'  
SCALE - 1 : 200

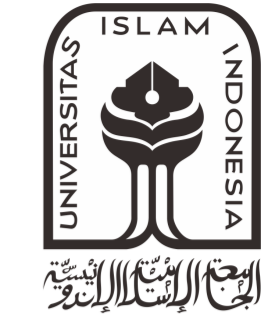

NUMBER OF PAGE	PAGE	LAYOUT ID
		A.13

APPROVED STAMP



PROJECT NAME

HUNIAN VERTIKAL DAN RETAIL,  
 GAMPINGAN, "RUMAH RAKYAT"  
 YOGYAKARTA



Jalan KH Ahmad Dahlan,  
 Gampingan, Kota Yogyakarta,  
 Daerah Istimewa Yogyakarta  
 Th. 2017/2018

DRAWING BY

MUHAMMAD FIQRON NASYWAN

NIM

14512178

APPROVAL

IR. SUPRIYANTA, M.SI

DRAWING TITLE

POTONGAN

BS-02

DRAWING SUBTITLE

POTONGAN B - B'

DRAWING SCALE

@A2, @A3  
 1 : 200



DRAWING STATUS

DED

DESCRIPTION

NUMBER OF PAGE	PAGE	LAYOUT ID
----------------	------	-----------

A.14

APPROVED STAMP

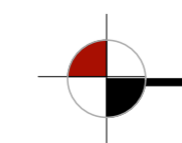
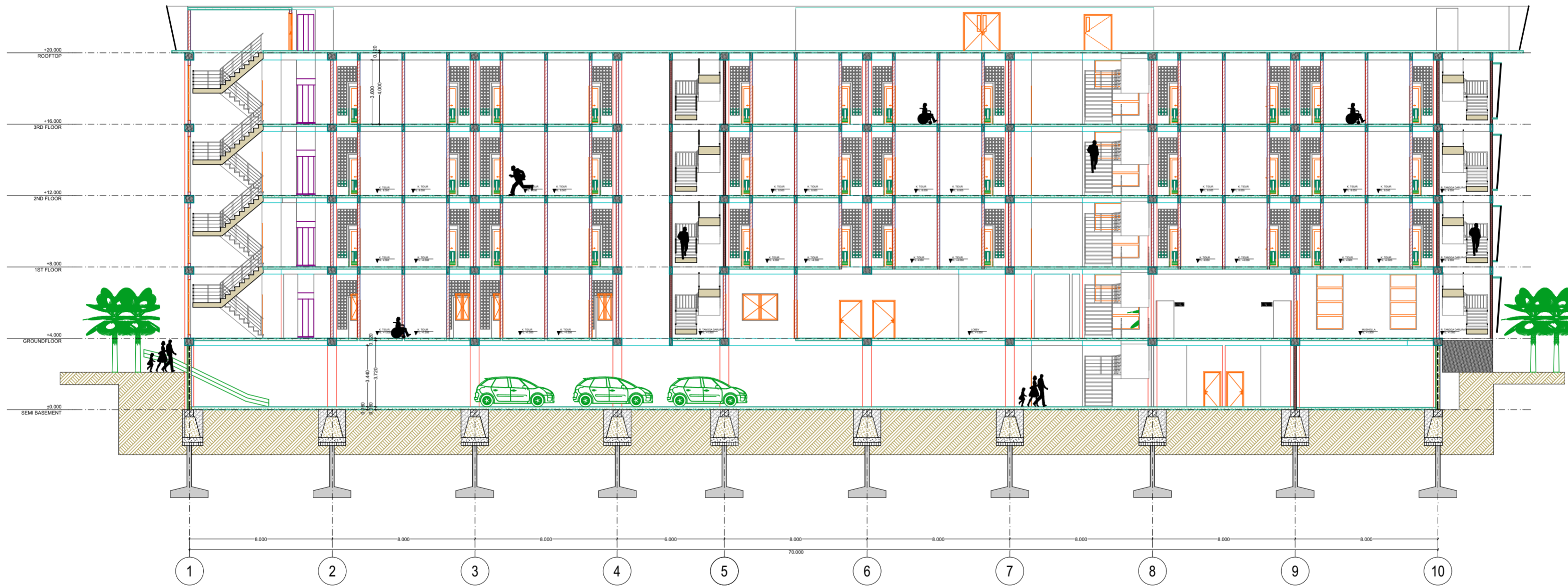

POTONGAN B - B'

SCALE - 1 : 200



PROJECT NAME

HUNIAN VERTIKAL DAN RETAIL,  
 GAMPINGAN, "RUMAH RAKYAT"  
 YOGYAKARTA



Jalan KH Ahmad Dahlan,  
 Gampingan, Kota Yogyakarta,  
 Daerah Istimewa Yogyakarta  
 Th. 2017/2018

DRAWING BY

MUHAMMAD FIQRON NASYWAN

NIM

14512178

APPROVAL

IR. SUPRIYANTA, M.SI

DRAWING TITLE

POTONGAN BS-03

DRAWING SUBTITLE

POTONGAN C - C'

DRAWING SCALE

@A2, @A3  
 1 : 200

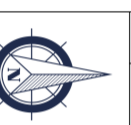

DRAWING STATUS

DED

DESCRIPTION

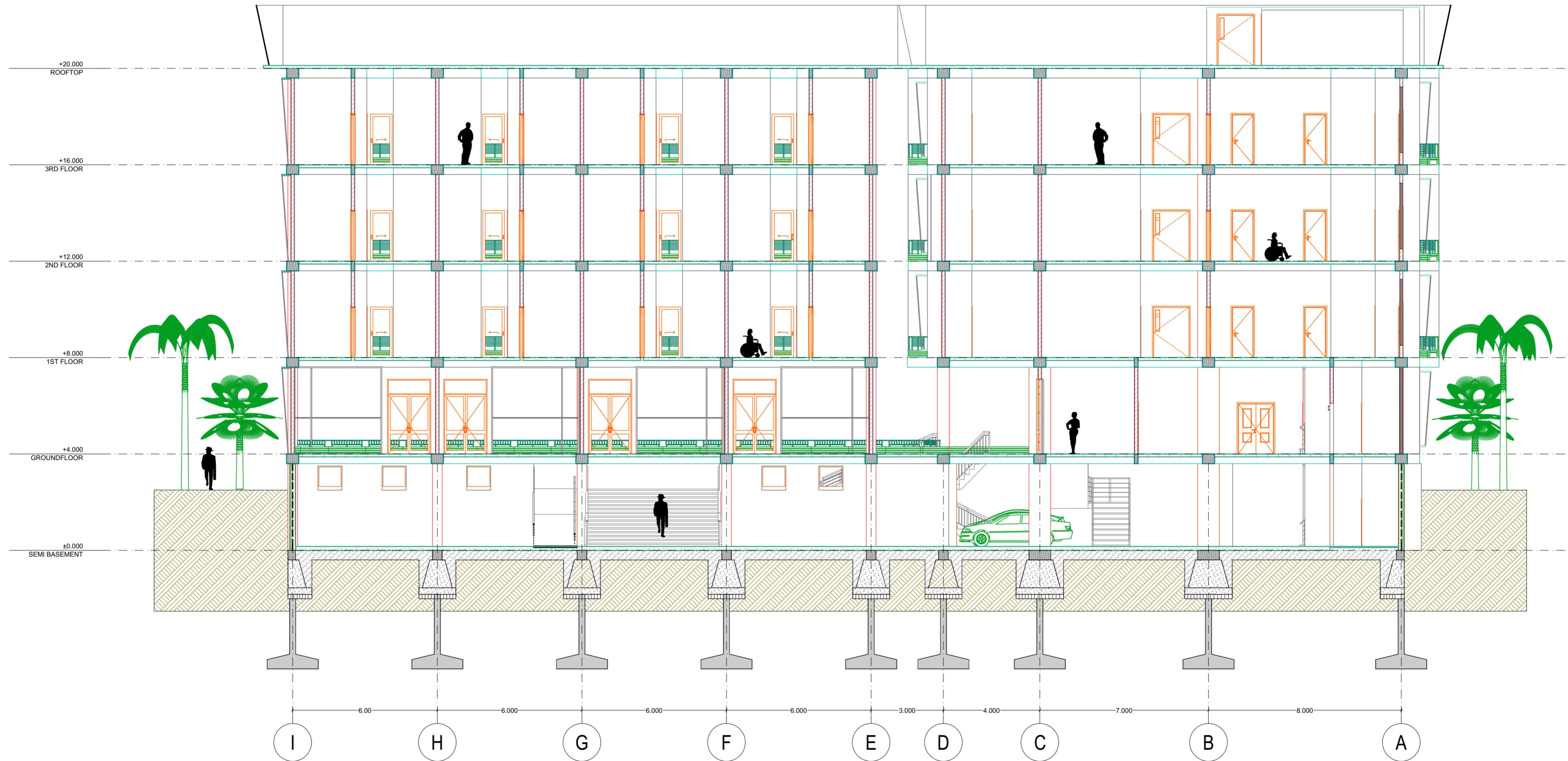

NUMBER OF PAGE	PAGE	LAYOUT ID
		A.16

A.16

APPROVED STAMP

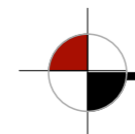

POTONGAN C - C'

SCALE - 1 : 200

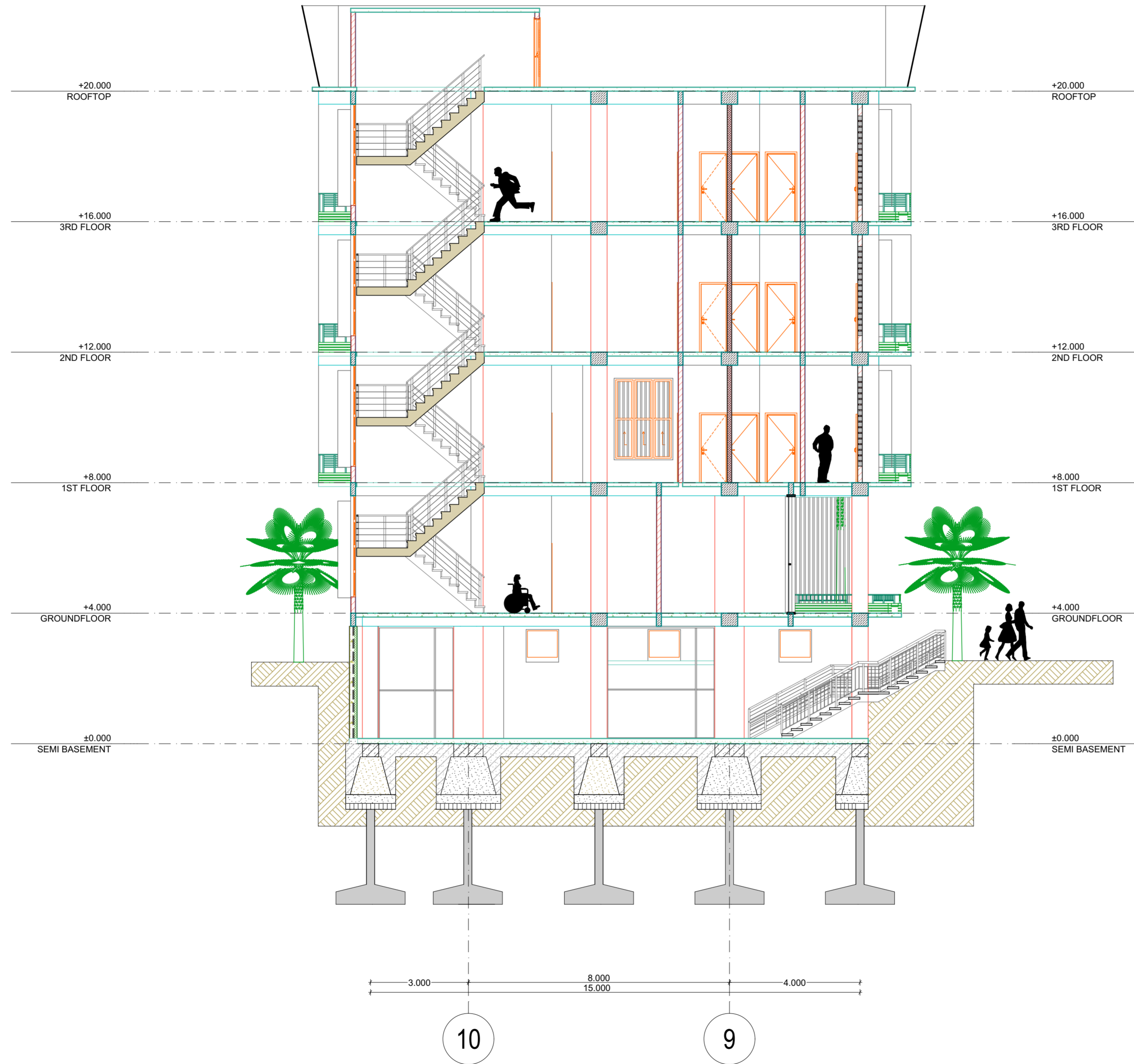

POTONGAN D - D'  
SCALE - 1 : 200

PROJEK AKHIR SARJANA



UNIVERSITAS ISLAM INDONESIA  
JL. KALIURANG KM 14.5, KAB. SLEMAN,  
DAERAH ISTIMEWA YOGYAKARTA

**PROJECT NAME**  
HUNIAN VERTIKAL DAN RETAIL,  
GAMPINGAN, "RUMAH RAKYAT"  
YOGYAKARTA  
Jalan KH Ahmad Dahlan,  
Gampingan, Kota Yogyakarta,  
Daerah Istimewa Yogyakarta  
Th. 2017/2018



**DRAWING BY**  
MUHAMMAD FIQRON NASYWAN

**NIM**  
14512178

**APPROVAL**  
IR. SUPRIYANTA, M.SI

**DRAWING TITLE**  
POTONGAN BS-04

**DRAWING SUBTITLE**  
POTONGAN D - D'

**DRAWING SCALE**  
@A2, @A3  
1 : 200

**DRAWING STATUS**  
DED



**DESCRIPTION**

NUMBER OF PAGE	PAGE	LAYOUT ID
		A.15

**APPROVED STAMP**



PROJECT NAME

HUNIAN VERTIKAL DAN RETAIL,  
GAMPINGAN, "RUMAH RAKYAT"  
YOGYAKARTA



Jalan KH Ahmad Dahlan,  
Gampingan, Kota Yogyakarta,  
Daerah Istimewa Yogyakarta  
Th. 2017/2018

DRAWING BY

MUHAMMAD FIQRON NASYWAN

NIM

14512178

APPROVAL

IR. SUPRIYANTA, M.SI

DRAWING TITLE

DRAWING SUBTITLE

ROOFTOP

DRAWING SCALE

@A2, @A3  
1 : 200



DRAWING STATUS

DED

DESCRIPTION

NUMBER OF PAGE

PAGE

LAYOUT ID

A.06

APPROVED STAMP

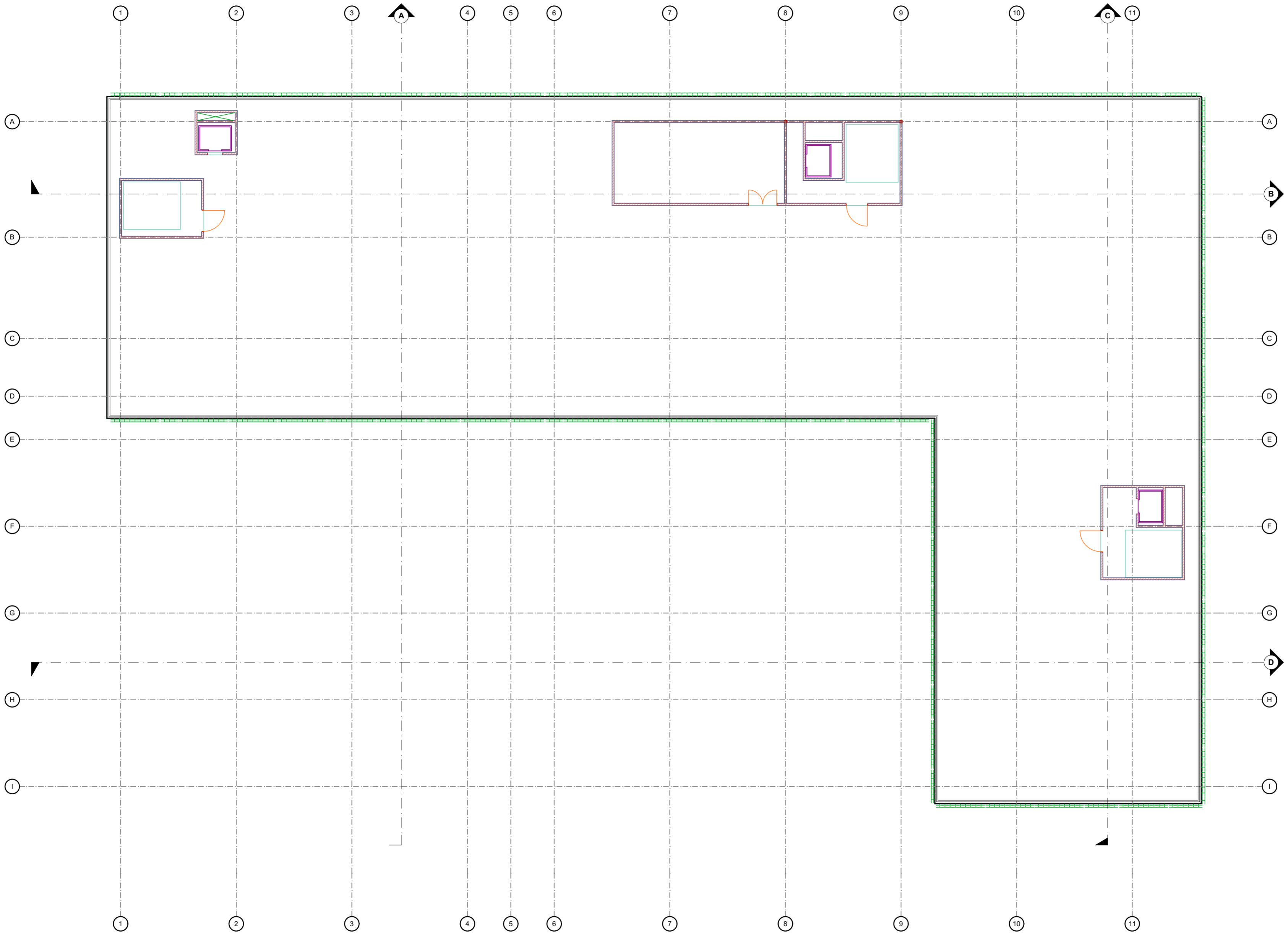





UNIVERSITAS ISLAM INDONESIA

JL. KALIURANG KM 14.5, KAB. SLEMAN, DAERAH ISTIMEWA YOGYAKARTA

PROJECT NAME

HUNIAN VERTIKAL DAN RETAIL, GAMPINGAN, "RUMAH RAKYAT" YOGYAKARTA

Jalan KH Ahmad Dahlan, Gampingan, Kota Yogyakarta, Daerah Istimewa Yogyakarta Th. 2017/2018



DRAWING BY

MUHAMMAD FIQRON NASYWAN

NIM

14512178

APPROVAL

IR. SUPRIYANTA, M.SI

DRAWING TITLE

MASTERPLAN M-00

DRAWING SUBTITLE

SITEPLAN

DRAWING SCALE

@A2, @A3  
1 : 200

DRAWING STATUS

DED

DESCRIPTION

NUMBER OF PAGE	PAGE	LAYOUT ID
		A.11

APPROVED STAMP



Jalan KH. Ahmad Dahlan

**SITEPLAN**  
SCALE - 1 : 200

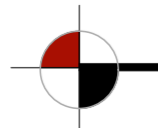



PROJECT NAME

HUNIAN VERTIKAL DAN RETAIL,  
 GAMPINGAN, "RUMAH RAKYAT"  
 YOGYAKARTA

Jalan KH Ahmad Dahlan,  
 Gampingan, Kota Yogyakarta,  
 Daerah Istimewa Yogyakarta  
 Th. 2017/2018



DRAWING BY

MUHAMMAD FIQRON NASYWAN

NIM

14512178

APPROVAL

IR. SUPRIYANTA, M.SI

DRAWING TITLE

TAMPAK

E-02

DRAWING SUBTITLE

TAMPAK BARAT

DRAWING SCALE

@A2, @A3  
 1 : 200



DRAWING STATUS

DED

DESCRIPTION

NUMBER OF PAGE

PAGE

LAYOUT ID

A.03

APPROVED STAMP

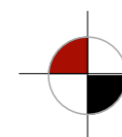

TAMPAK BARAT  
 SCALE - 1 : 200



PROJECT NAME

HUNIAN VERTIKAL DAN RETAIL  
 GAMPINGAN "RUMAH RAKYAT"  
 YOGYAKARTA

Jalan KH Ahmad Dahlan,  
 Gampingan, Kota Yogyakarta,  
 Daerah Istimewa Yogyakarta  
 Th. 2017/2018



DRAWING BY

MUHAMMAD FIQRON NASYWAN

NIM

14512178

APPROVAL

IR. SUPRIYANTA, M.SI

DRAWING TITLE

TAMPAK

E-01

DRAWING SUBTITLE

TAMPAK SELATAN

DRAWING SCALE

@A2, @A3  
 1 : 200



DRAWING STATUS

DED

DESCRIPTION

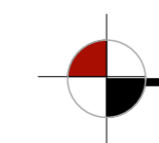
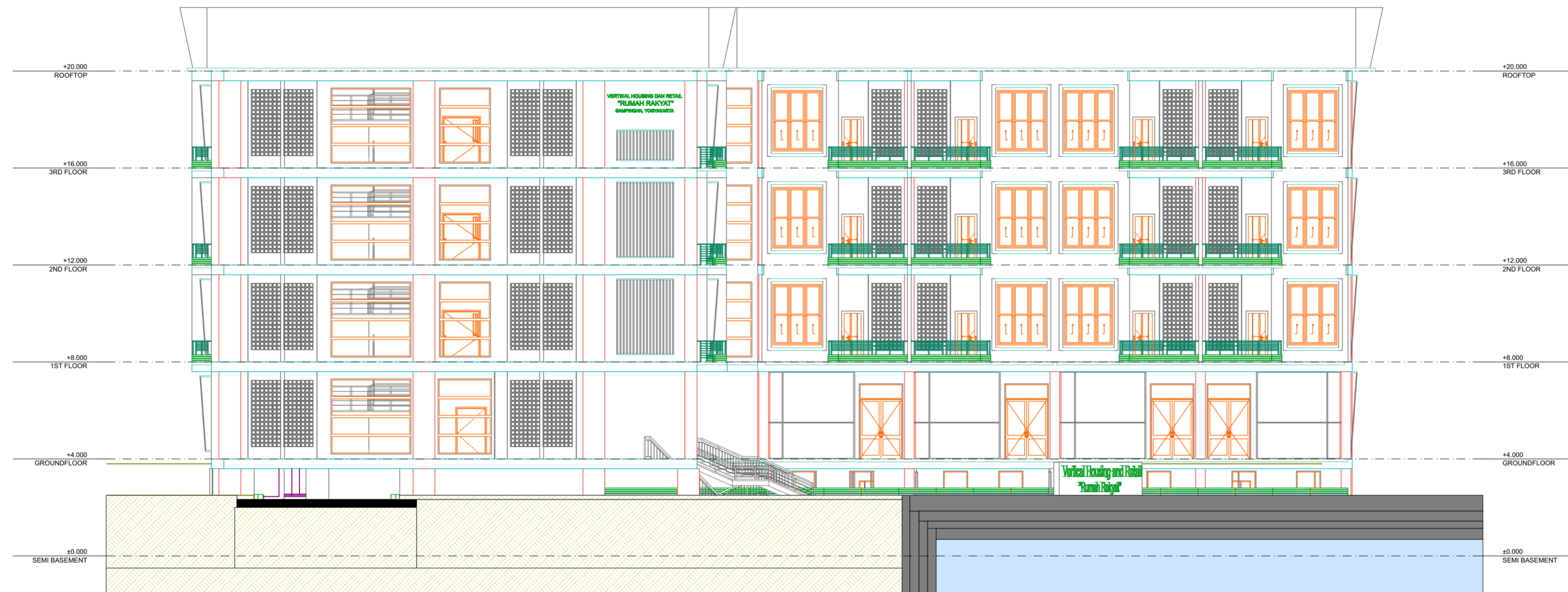

TAMPAK SELATAN  
 SCALE - 1 : 200

NUMBER OF PAGE	PAGE	LAYOUT ID
		A.01

APPROVED STAMP



PROJECT NAME

HUNIAN VERTIKAL DAN RETAIL,  
 GAMPINGAN, "RUMAH RAKYAT"  
 YOGYAKARTA

Jalan KH Ahmad Dahlan,  
 Gampingan, Kota Yogyakarta,  
 Daerah Istimewa Yogyakarta  
 Th. 2017/2018



DRAWING BY

MUHAMMAD FIQRON NASYWAN

NIM

14512178

APPROVAL

IR. SUPRIYANTA, M.SI

DRAWING TITLE

TAMPAK

E-04

DRAWING SUBTITLE

TAMPAK TIMUR

DRAWING SCALE

@A2, @A3  
 1 : 200



DRAWING STATUS

DED

DESCRIPTION

NUMBER OF PAGE

PAGE

LAYOUT ID

A.01

APPROVED STAMP

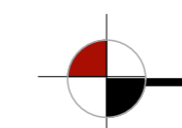

TAMPAK TIMUR  
 SCALE - 1 : 200



PROJECT NAME

HUNIAN VERTIKAL DAN RETAIL  
GAMPINGAN, "RUMAH RAKYAT"  
YOGYAKARTA



Jalan KH Ahmad Dahlan,  
Gampingan, Kota Yogyakarta,  
Daerah Istimewa Yogyakarta  
Th. 2017/2018

DRAWING BY

MUHAMMAD FIQRON NASYWAN

NIM

14512178

APPROVAL

IR. SUPRIYANTA, M.SI

DRAWING TITLE

TAMPAK

E-03

DRAWING SUBTITLE

TAMPAK UTARA

DRAWING SCALE

@A2, @A3  
1 : 200



DRAWING STATUS

DED

DESCRIPTION

NUMBER OF PAGE

PAGE

LAYOUT ID

A.02

APPROVED STAMP

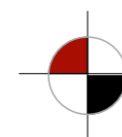

TAMPAK UTARA  
SCALE - 1 : 200

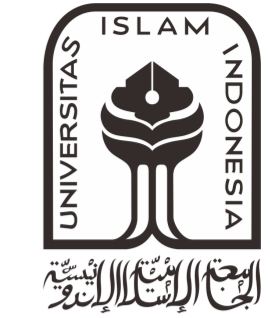
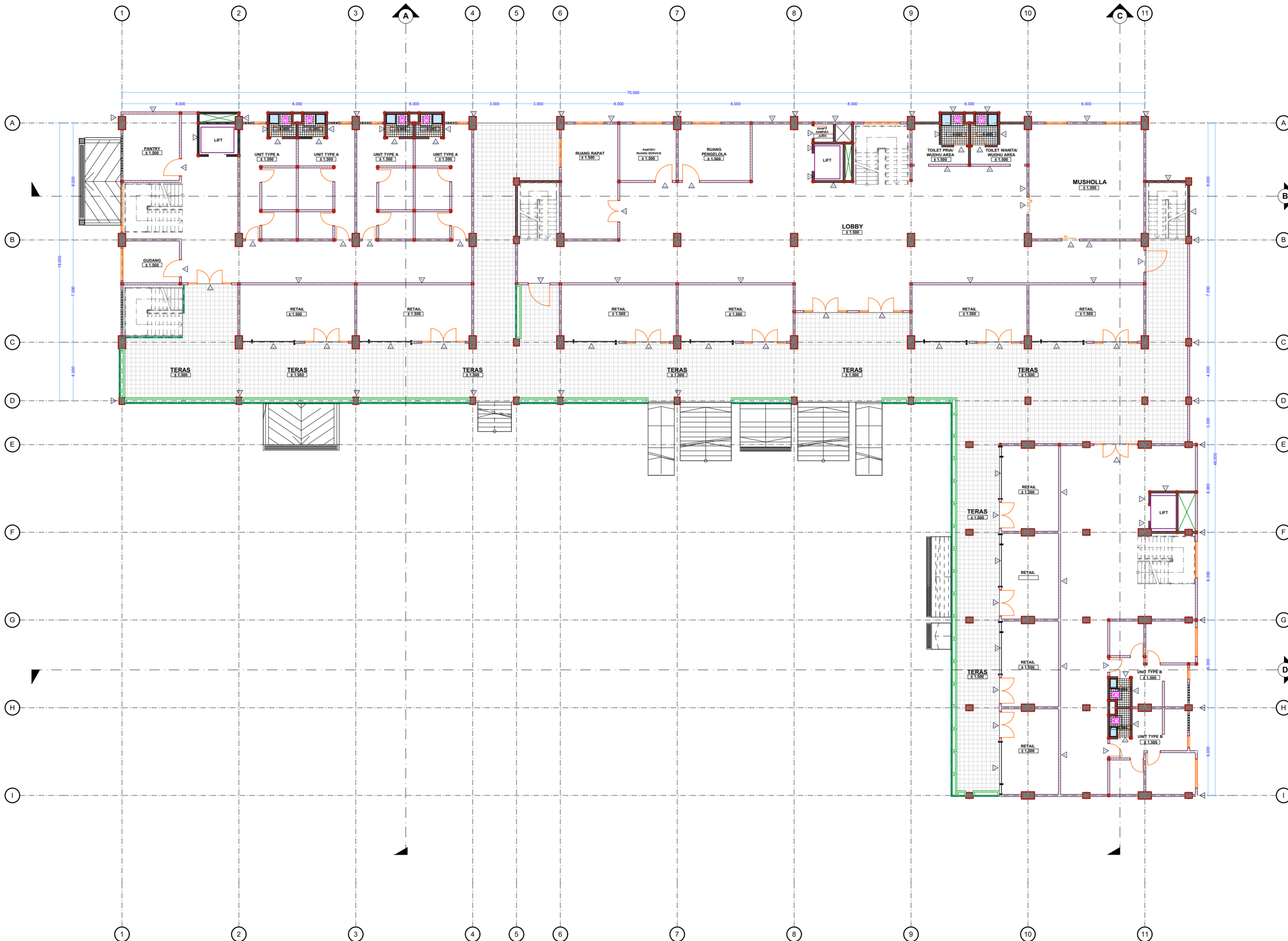

DESCRIPTION

BE	BRICKWALL PLASTERED & PAINTED W/ ACRYLIC EMULSION PAINT
CE	CONCRETEWALL PLASTERED & PAINTED W/ WATERPROOF PAINT
CCE	CONCRETE COLUMN PLASTERED & PAINTED W/ ACRYLIC EMULSION PAINT
HPD	HONEYCOMB PVC WOODEN DOOR w/ PVC WOOD FRAME & DOUBLE HMR PVC FINISHING
PFD	PVC TOILET DOOR w/ PVC SOLID COLOR FINISHING
FLD	FRAMELESS DOOR w/ 12mm TEMPERED TINTED GLASS
SFD	SINGLE STEEL FIRE DOOR w/ STEEL 2MM FRAME ROCKWOOL & FINISHING DUCO PAINT BRASS
ACW	ALUMINIUM POWDER COATING CASEMENT WINDOW (WHITE COLOR) w/ 5mm TINTED GLASS
ASD	ALUMINIUM POWDER COATING SLIDING WINDOW (WHITE COLOR) w/ 5mm TINTED GLASS
CW	CURTAIN WALL w/ 12mm TEMPERED TINTED GLASS
BWB	BRICKWALL W/ BOTTLE PARTITION
CBW	CONCRETE BASEMENTWALL W/ SOLID COLOR FINISHING
SD	STEEL DOOR W/ STEEL FRAME (WHITE COLOR) "PINTU ANGKAT"

EXCLUDED:  
 -FLOOR FINISHING  
 -RAILING  
 -STAIR CASE

NUMBER OF PAGE	PAGE	LAYOUT ID
		A.10

APPROVED STAMP

GROUND FLOOR  
 SCALE - 1 : 200



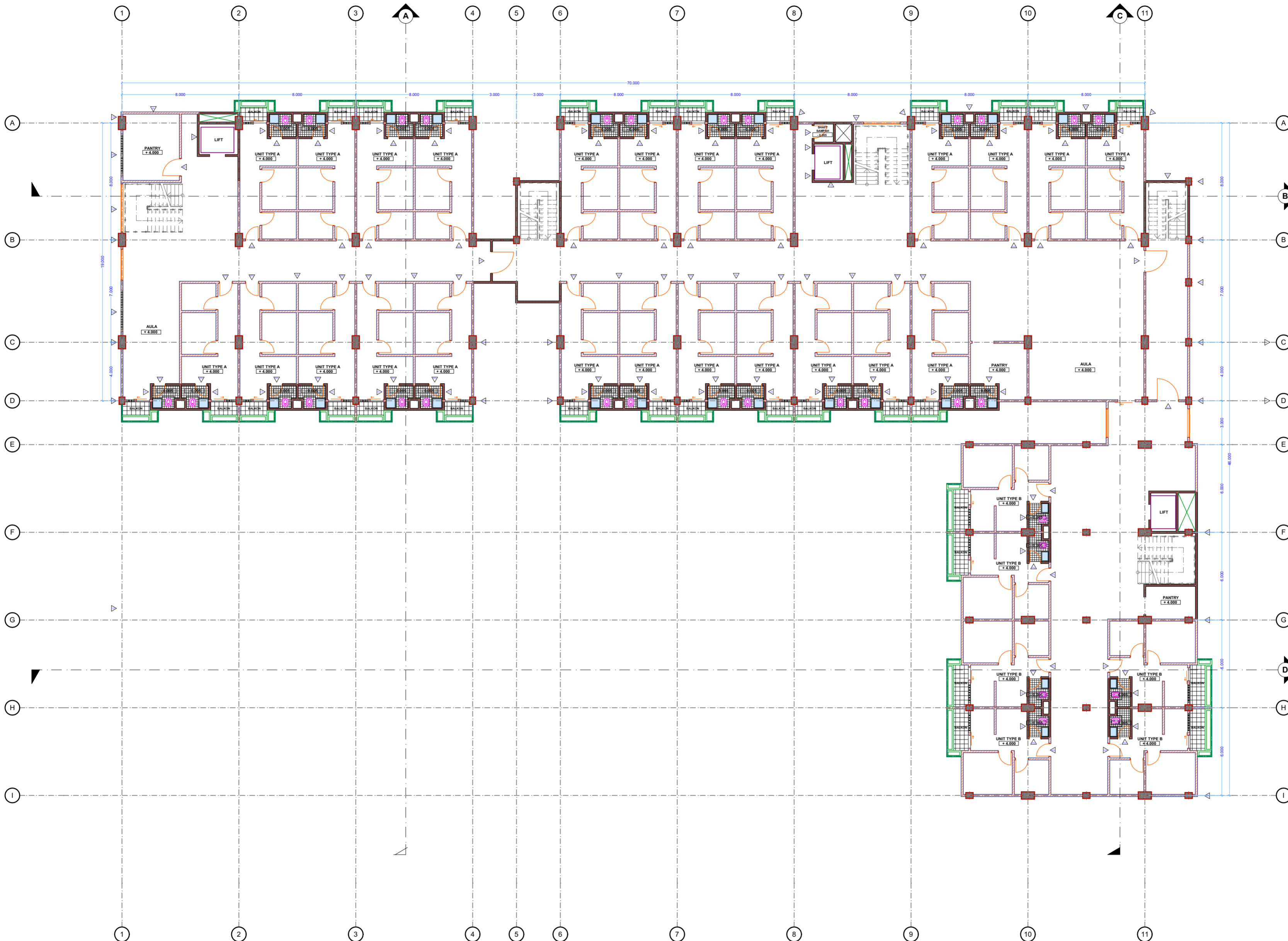

**DENAH LANTAI 1 - TYPICAL**  
 SCALE - 1 : 200

**PROJEK AKHIR SARJANA**



**UNIVERSITAS ISLAM INDONESIA**  
 JL. KALURANG KM 14.5, KAB. SLEMAN, DAERAH ISTIMEWA YOGYAKARTA

**PROJECT NAME**  
 HUNIAN VERTIKAL DAN RETAIL, GAMPINGAN, "RUMAH RAKYAT" YOGYAKARTA



**DRAWING BY**  
 MUHAMMAD FIGRON NASYWAN

**NIM**  
 14512178

**APPROVAL**  
 IR. SUPRIYANTA, M.SI

**DRAWING TITLE**  
 DENAH D-02

**DRAWING SUBTITLE**  
 DENAH LANTAI 1 - TYPICAL

**DRAWING SCALE**  
 @A2, @A3  
 1 : 200

**DRAWING STATUS**  
 DED

**DESCRIPTION**

BE	BRICKWALL PLASTERED & PAINTED W/ ACRYLIC EMULSION PAINT
CE	CONCRETEWALL PLASTERED & PAINTED W/ WATERPROOF PAINT
CCE	CONCRETE COLUMN PLASTERED & PAINTED W/ ACRYLIC EMULSION PAINT
HPD	HONEYCOMB PVC WOODEN DOOR w/ PVC WOOD FRAME & DOUBLE HMR PVC FINISHING
PFD	PVC TOILET DOOR w/ PVC SOLID COLOR FINISHING
FLD	FRAMELESS DOOR w/ 12mm TEMPERED TINTED GLASS
SFD	SINGLE STEEL FIRE DOOR w/ STEEL 2MM FRAME ROCKWOOL & FINISHING DUCO PAINT BRASS
ACW	ALUMINIUM POWDER COATING CASEMENT WINDOW (WHITE COLOR) w/ 5mm TINTED GLASS
ASD	ALUMINIUM POWDER COATING SLIDING WINDOW (WHITE COLOR) w/ 5mm TINTED GLASS
CW	CURTAIN WALL w/ 12mm TEMPERED TINTED GLASS
BWB	BRICKWALL W/ BOTTLE PARTITION
CBW	CONCRETE BASEMENTWALL W/ SOLID COLOR FINISHING
SD	STEEL DOOR W/ STEEL FRAME (WHITE COLOR) "PINTU ANGKAT"

EXCLUDED:  
 -FLOOR FINISHING  
 -RAILING  
 -STAIR CASE

NUMBER OF PAGE	PAGE	LAYOUT ID
		A.09

**APPROVED STAMP**



PROJECT NAME

HUNIAN VERTIKAL DAN RETAIL,  
 GAMPINGAN, "RUMAH RAKYAT"  
 YOGYAKARTA



Jalan KH Ahmad Dahlan,  
 Gampingan, Kota Yogyakarta,  
 Daerah Istimewa Yogyakarta  
 Th. 2017/2018

DRAWING BY

MUHAMMAD FIGRON NASYWAN

NIM

14512178

APPROVAL

IR. SUPRIYANTA, M.SI

DRAWING TITLE

RENCANA  
 SKEMATIK

RS-01

DRAWING SUBTITLE

SKEMA FIRE PROTECTION DAN  
 TITIK KUMPUL

DRAWING SCALE

@A2, @A3  
 1 : 200



DRAWING STATUS

DED

DESCRIPTION

	HYDRANTBOX "TYPE A1"
	APAR " Viking " 6 Kg
	MANUAL CALLPOINT, FA-05-01, HORING LIH
	FIRE STROBE LIGHT, FA 04-02
	FIRE ALARM BELL, FA04-01

JALUR EVAKUASI

TANGGA DARURAT

TITIK KUMPUL SAVING POINT

NUMBER OF PAGE	PAGE	LAYOUT ID
----------------	------	-----------

A.01

APPROVED STAMP

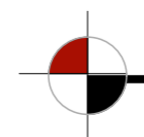
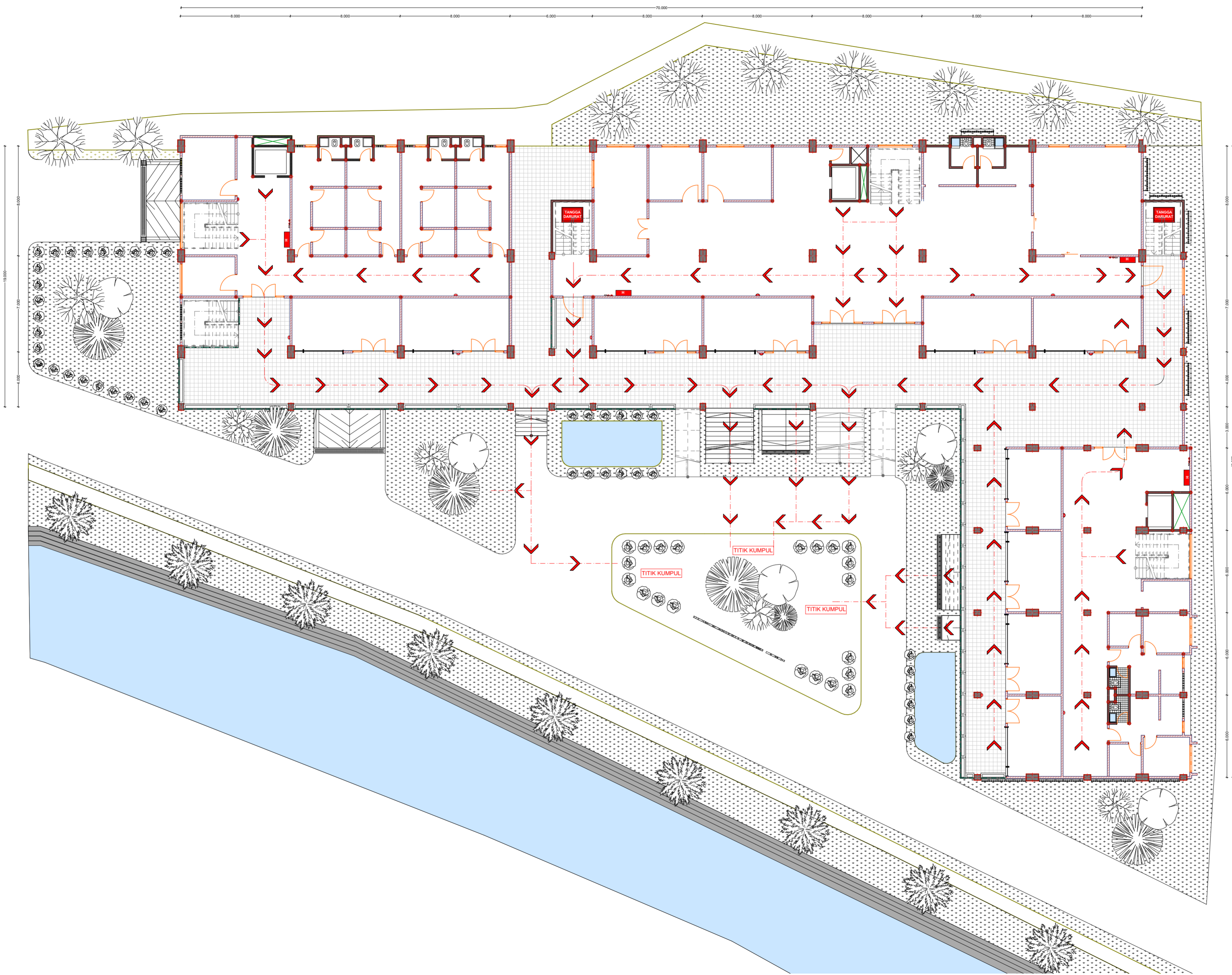

SKEMA FIRE PROTECTION DAN TITIK KUMPUL

SCALE - 1 : 200



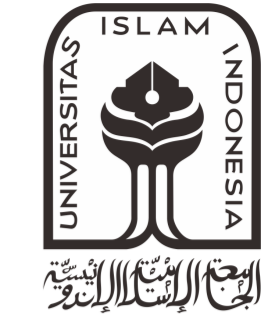
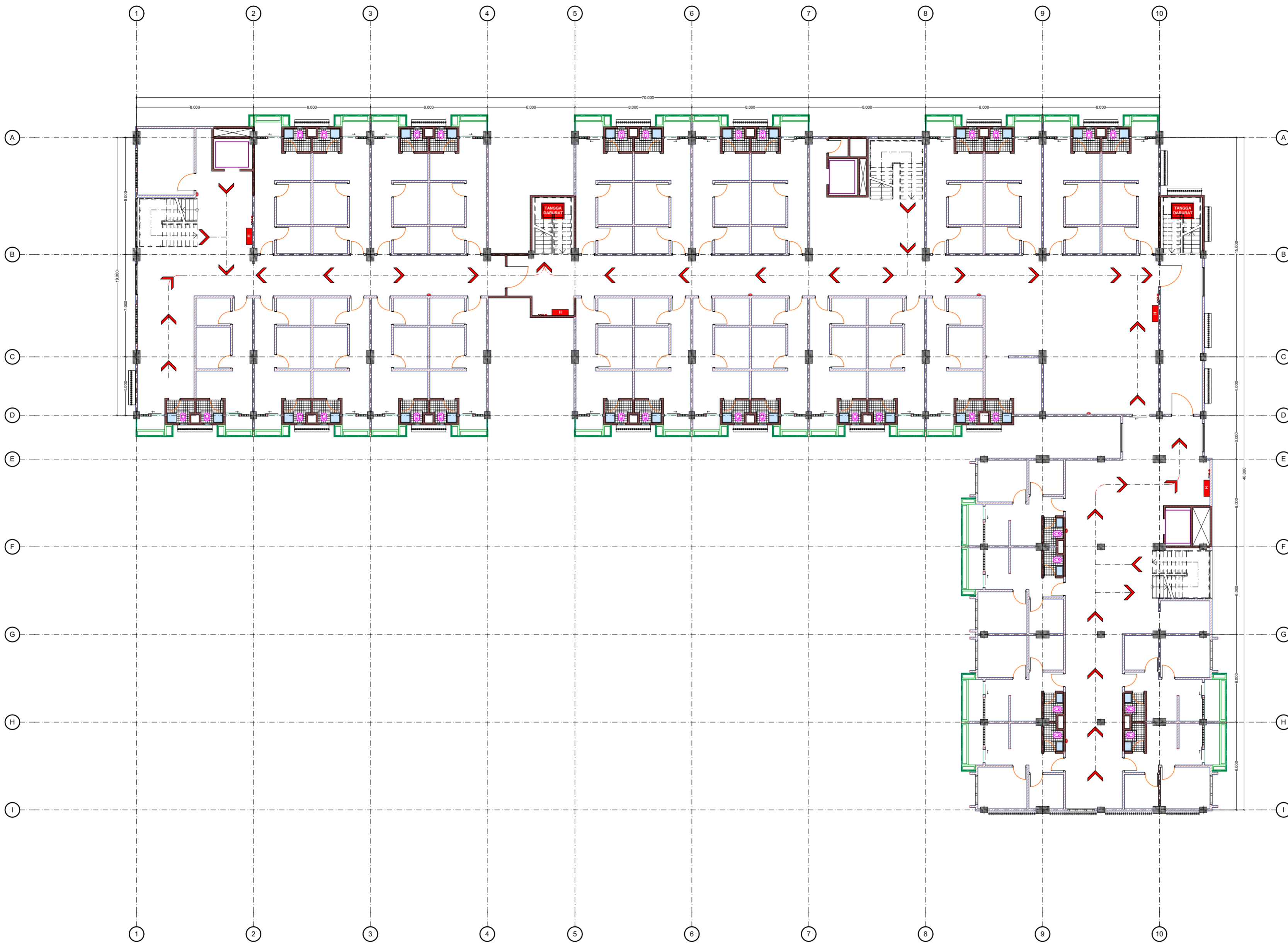

DESCRIPTION

- H** HYDRANTBOX "TYPE A1"
- A** APAR " Viking " 6 Kg
- M** MANUAL CALLPOINT, FA-05-01,  
HORING LIH
- S** FIRE STROBE LIGHT, FA 04-02
- B** FIRE ALARM BELL, FA04-01

JALUR EVAKUASI

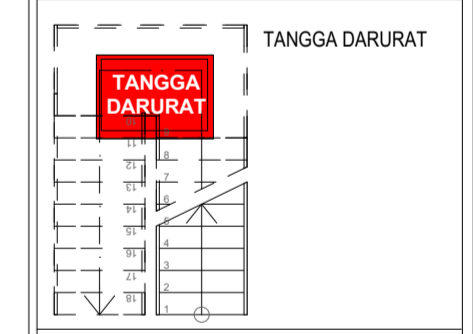

TITIK KUMPUL SAVING POINT

NUMBER OF PAGE	PAGE	LAYOUT ID
		A.02

APPROVED STAMP



PROJECT NAME

HUNIAN VERTIKAL DAN RETAIL,  
 GAMPINGAN, "RUMAH RAKYAT"  
 YOGYAKARTA



Jalan KH Ahmad Dahlan,  
 Gampingan, Kota Yogyakarta,  
 Daerah Istimewa Yogyakarta  
 Th. 2017/2018

DRAWING BY

MUHAMMAD FIGRON NASYWAN

NIM

14512178

APPROVAL

IR. SUPRIYANTA, M.SI

DRAWING TITLE

RENCANA  
 SKEMATIK

DRAWING SUBTITLE

SKEMA AIR BERSIH

DRAWING SCALE

@A2, @A3  
 1 : 200

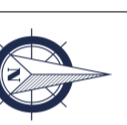

DRAWING STATUS

DED

DESCRIPTION

JALUR AIR DINGIN

JALUR AIR PANAS

NUMBER OF PAGE	PAGE	LAYOUT ID
		A.01

APPROVED STAMP

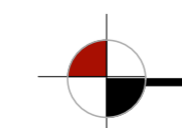
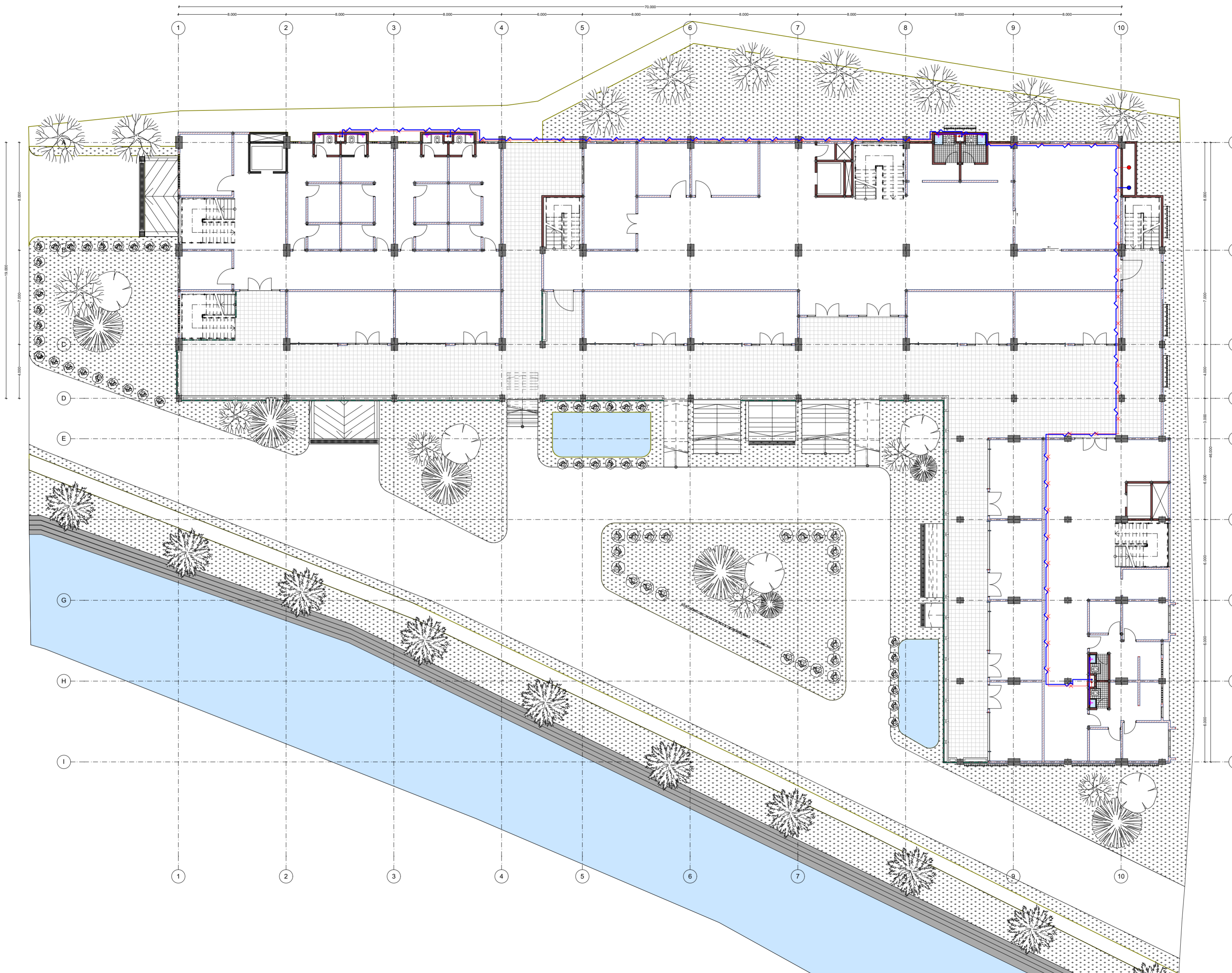

SKEMA AIR BERSIH

SCALE - 1 : 200

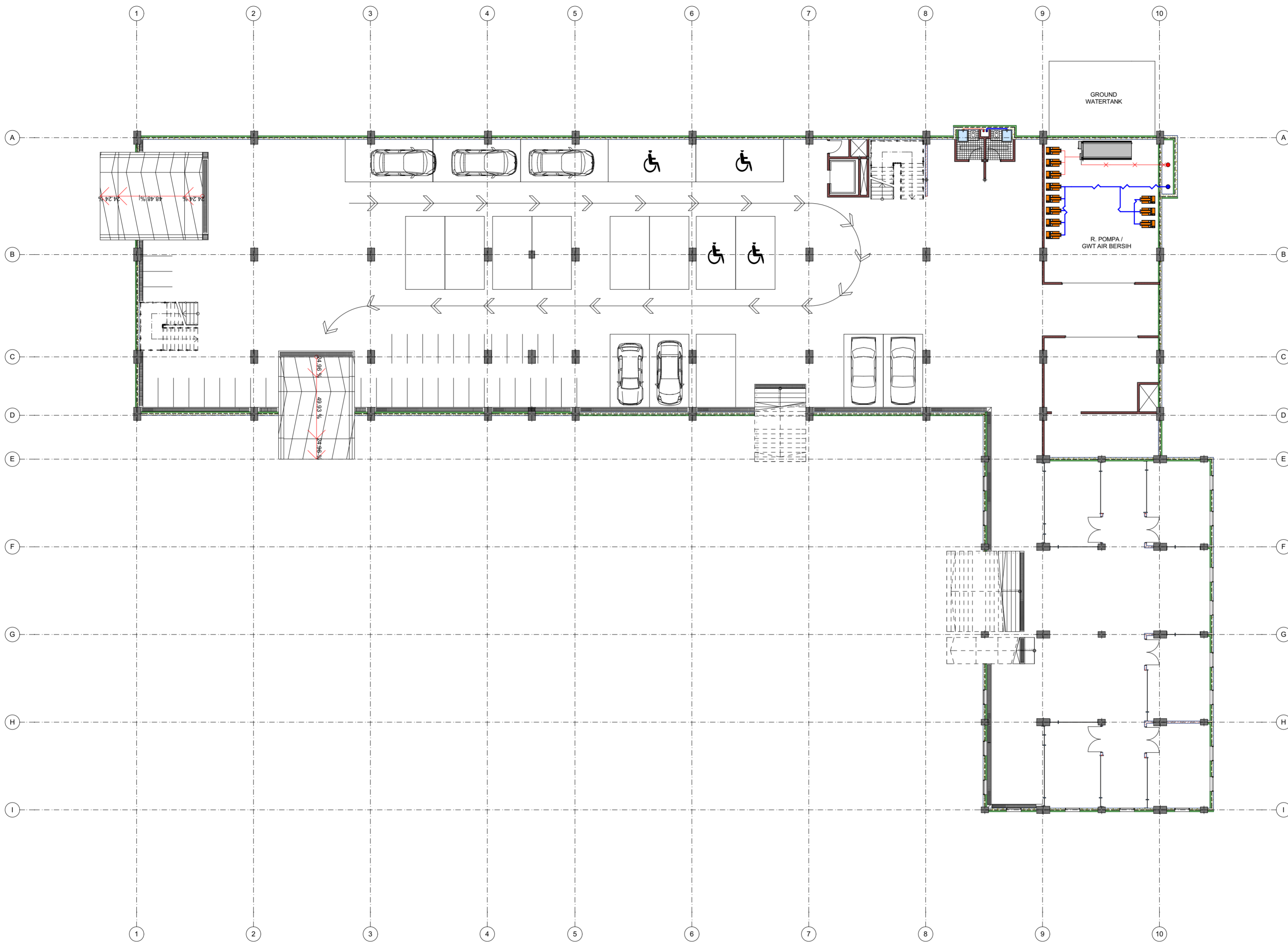



**SKEMA AIR BERSIH DAN GWT BASEMENT**  
**SCALE - 1 : 200**

**PROJEK AKHIR SARJANA**



**UNIVERSITAS ISLAM INDONESIA**  
 Jl. Kaliurang Km 14.5, Kab. Sleman,  
 Daerah Istimewa Yogyakarta

<b>PROJECT NAME</b>		
Hunian Vertikal dan Retail, Gampingan, "RUMAH RAKYAT" Yogyakarta		
<b>DRAWING BY</b>		
MUHAMMAD FIQRON NASYWAN		
<b>NIM</b>		
14512178		
<b>APPROVAL</b>		
IR. SUPRIYANTA, M.Si		
<b>DRAWING TITLE</b>		
RENCANA SKEMATIK		
<b>DRAWING SUBTITLE</b>		
SKEMA AIR BERSIH DAN GWT BASEMENT		
<b>DRAWING SCALE</b>		<b>DRAWING STATUS</b>
@A2, @A3 1 : 200		DED
<b>DESCRIPTION</b>		
<u>JALUR AIR DINGIN</u> <u>JALUR AIR PANAS</u>		
<b>NUMBER OF PAGE</b>	<b>PAGE</b>	<b>LAYOUT ID</b>
		A.02
<b>APPROVED STAMP</b>		

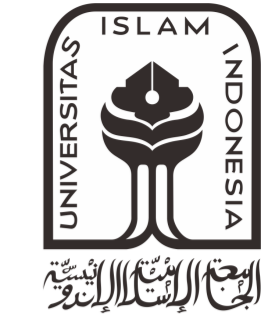
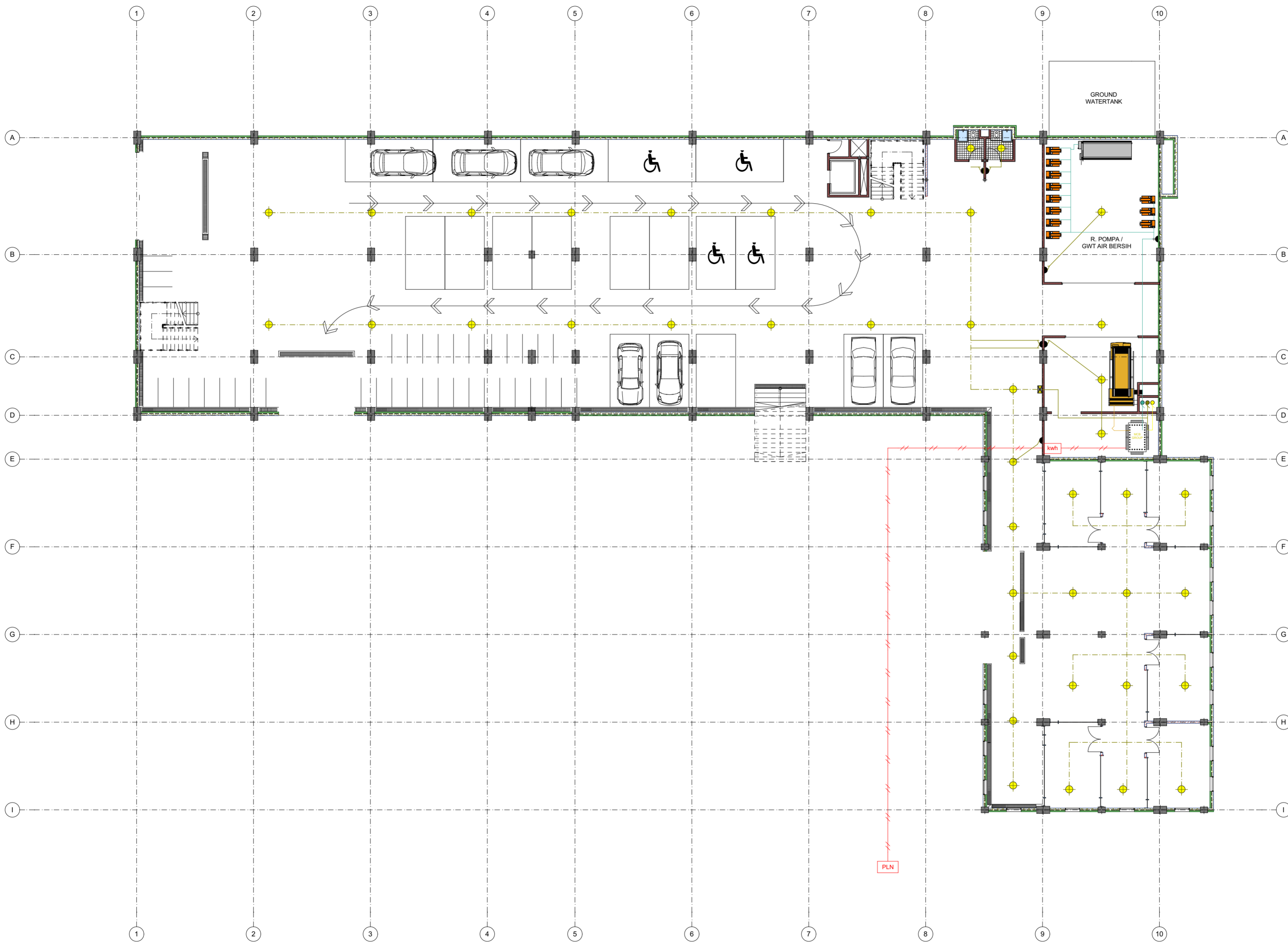

DESCRIPTION

	PLN
JALUR PLN	
	LAMPU
	Kwh Box
	METERAN BOX
	SAKLAR GANDA, TUNGGAL
	MESIN GENSET
	ARUS POMPA AIR
	ARUS GROUP 1 BASEMENT - LT 1
	GROUP 2, LT2 - LT3 LIFT
	MCB GROUP

NUMBER OF PAGE	PAGE	LAYOUT ID
		A.01

APPROVED STAMP