

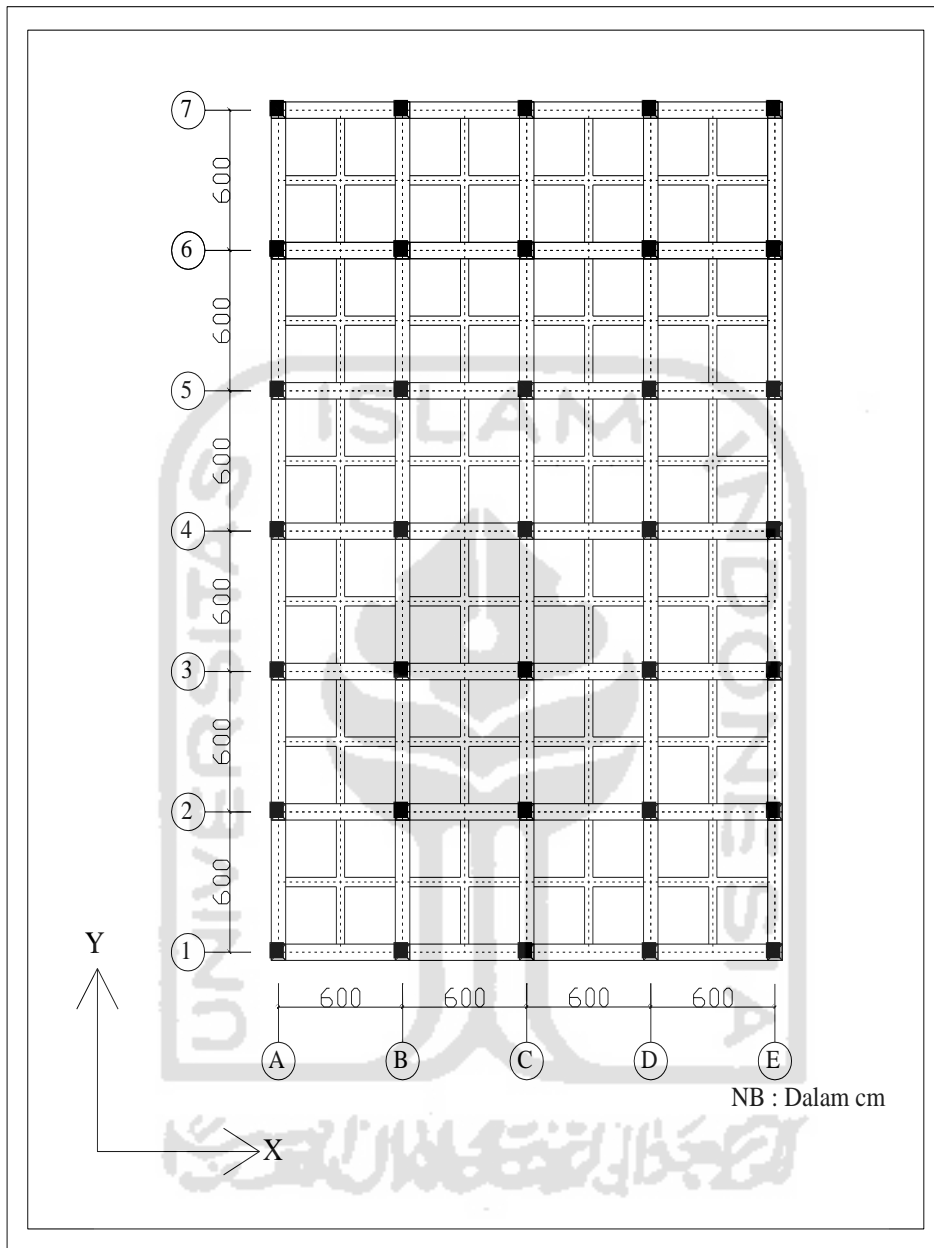

Lampiran 1. Denah Bangunan pada Kedua Gedung



Lampiran 2. Detail Balok Induk (B1) Lantai 1

Lantai	Dimensi Balok B1 (250 x 400)		
Lantai 1			
Dacrah	Tum Kiri	Lapangan	Tum Kanan
Tul Atas	6D22	3D22	6D22
Tul Bawah	3D22	6D22	3D22
Sengkang	P10 - 90	P10 - 200	P10 - 90

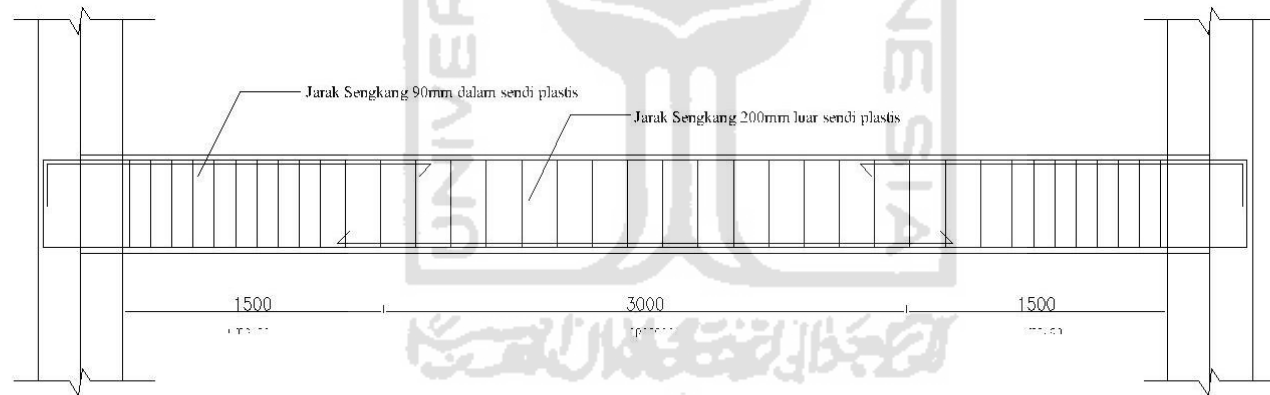

POTONGAN MEMANJANG B1 LANTAI 1

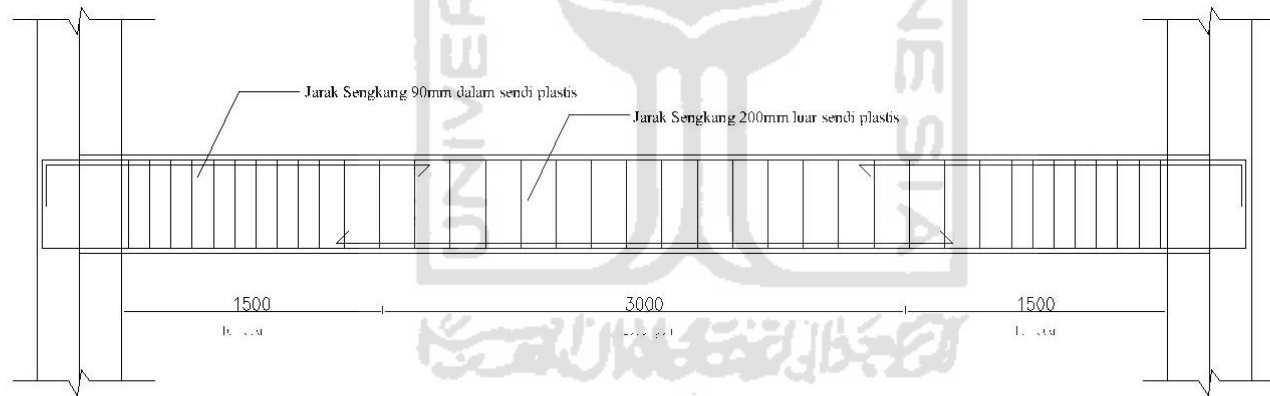

Lampiran 3. Detail Balok Induk (B1) Lantai 2

Dimensi		Balok B1 (250 x 400)		
Lantai				
Lantai 2				
Dacrah		Tum Kiri	Lapangan	Tum Kanan
Tul Atas		6D22	3D22	6D22
Tul Bawah		3D22	6D22	3D22
Sengkang		P10 - 90	P10 - 200	P10 - 90



POTONGAN MEMANJANG B1 LANTAI 2

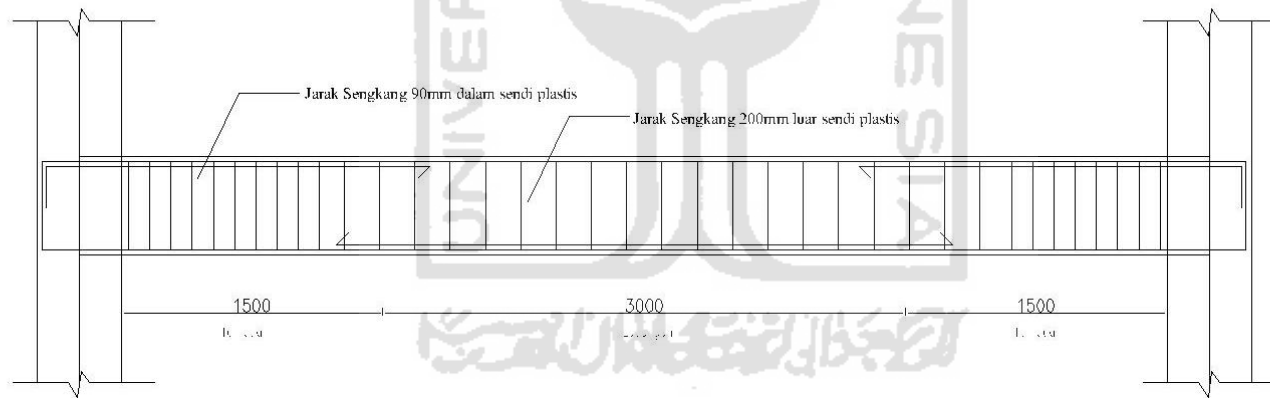

Lampiran 4. Detail Balok Induk (B1) Lantai 3

Dimensi	Balok B1 (250 x 400)		
Lantai			
Lantai 3			
Dacrah	Tum Kiri	Lapangan	Tum Kanan
Tul Atas	6D22	3D22	6D22
Tul Bawah	3D22	6D22	3D22
Sengkang	P10 - 90	P10 - 200	P10 - 90



POTONGAN MEMANJANG B1 LANTAI 3

Lampiran 5. Detail Balok Induk (B1) Lantai 4

Dimensi		Balok B1 (250 x 400)		
Lantai				
Lantai 3				
Dacrah		Tum Kiri	Lapangan	Tum Kanan
Tul Atas		4D22	3D22	4D22
Tul Bawah		3D22	4D22	3D22
Sengkang		P10 - 90	P10 - 200	P10 - 90

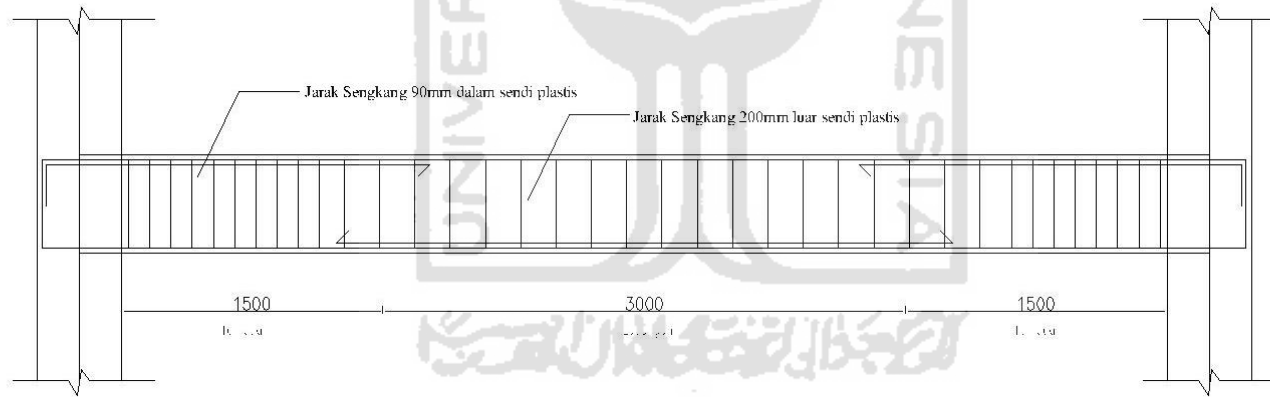

POTONGAN MEMANJANG B1 LANTAI 4

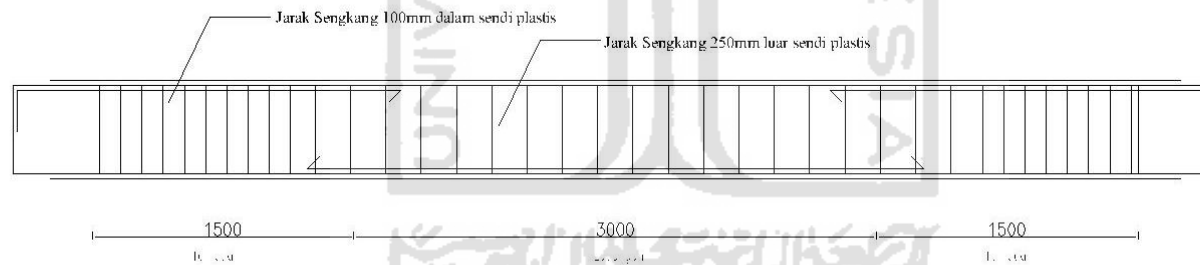

Lampiran 6. Detail Balok Anak (Ba1) Lantai 1

Dimensi	Balok B1 (250 x 300)		
Lantai			
Lantai 1			
Dacrah	Tum Kiri	Lapangan	Tum Kanan
Tul Atas	4D19	3D19	4D19
Tul Bawah	3D19	4D19	3D19
Sengkang	P10 - 100	P10 - 250	P10 - 100



POTONGAN MEMANJANG Ba1 LANTAI 1

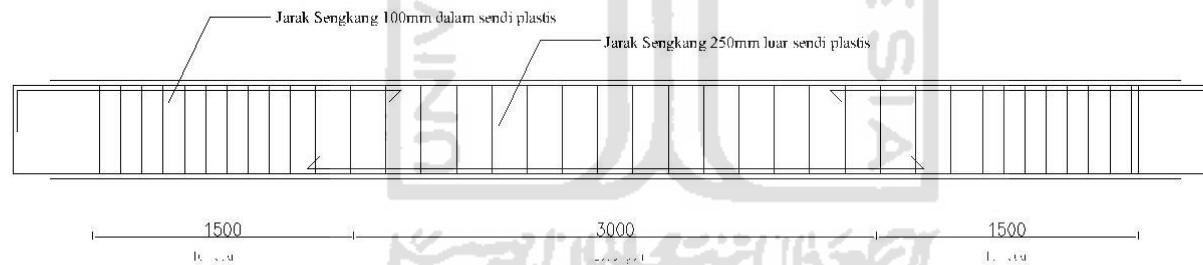

Lampiran 7. Detail Balok Anak (Ba1) Lantai 2

Dimensi	Balok Ba1 (200 x 300)		
Lantai			
Lantai 2			
Dacrah	Tum Kiri	Lapangan	Tum Kanan
Tul Atas	4D19	3D19	4D19
Tul Bawah	3D19	4D19	3D19
Sengkang	P10 - 100	P10 - 250	P10 - 100



POTONGAN MEMANJANG Ba1 LANTAI 2

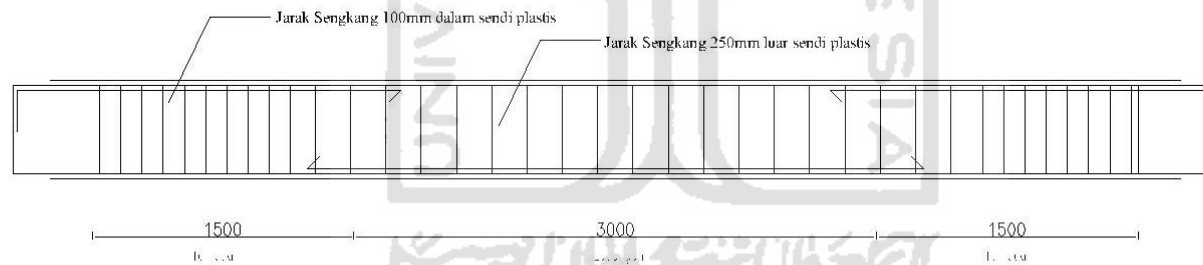

Lampiran 8. Detail Balok Anak (Ba1) Lantai 3

Dimensi	Balok Ba1 (200 x 300)		
Lantai			
Lantai 3			
Dacrah	Tum Kiri	Lapangan	Tum Kanan
Tul Atas	4D19	3D19	4D19
Tul Bawah	3D19	4D19	3D19
Sengkang	P10 - 100	P10 - 250	P10 - 100



POTONGAN MEMANJANG Ba1 LANTAI 3

Lampiran 9. Detail Balok Anak (Ba1) Lantai 4

Dimensi		Balok Ba1 (200 x 300)		
Lantai				
Lantai 4				
Dacrah		Tum Kiri	Lapangan	Tum Kanan
Tul Atas		4D19	3D19	4D19
Tul Bawah		3D19	4D19	3D19
Sengkang		P10 - 100	P10 - 250	P10 - 100

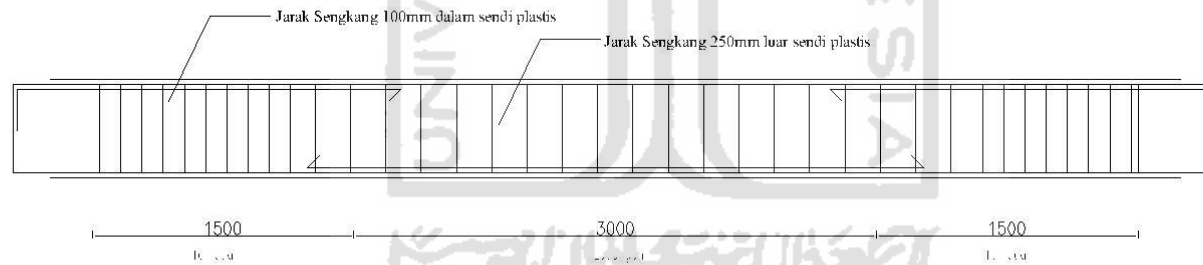

POTONGAN MEMANJANG Ba1 LANTAI 4

Lampiran 10. Detail Kolom 1 dan Kolom 2

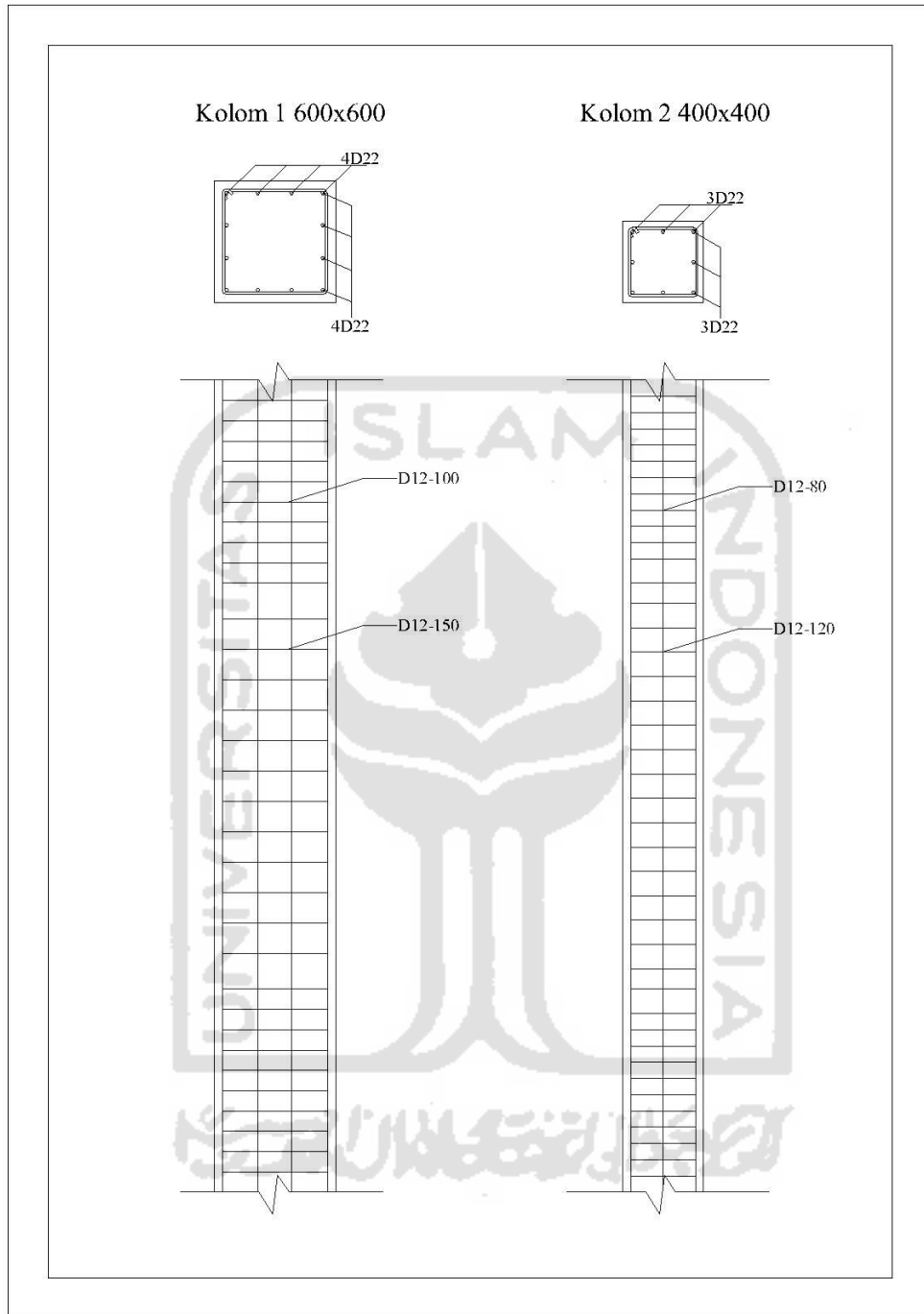

Lampiran 11. Sendi Plastis Arah X Gedung 1 pada Step-1 dan Step-2

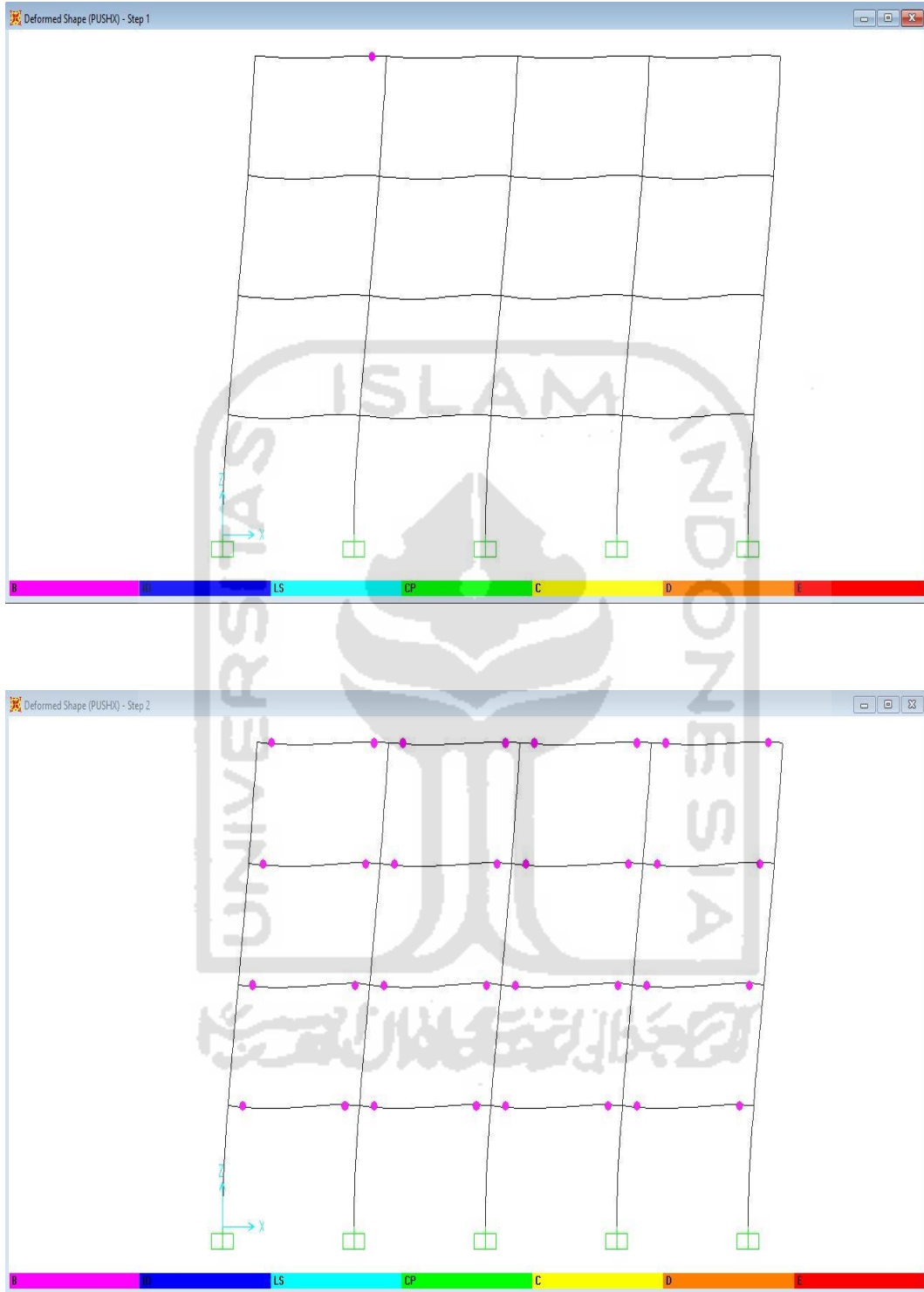

Lampiran 12. Sendi Plastis Arah X Gedung 1 pada Step-3 dan Step-4

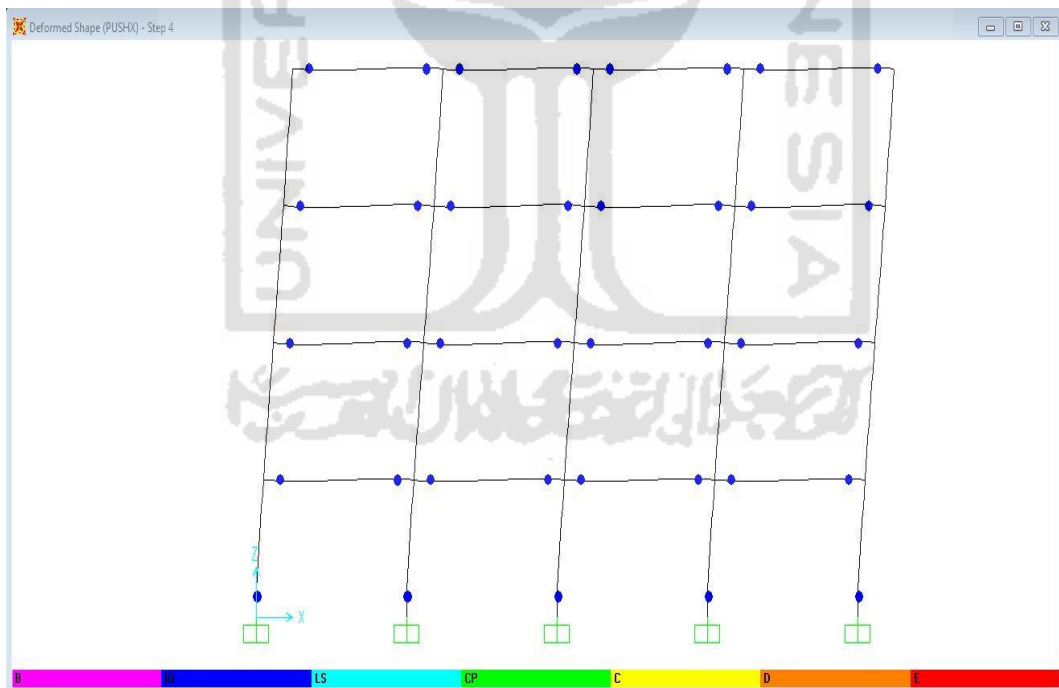
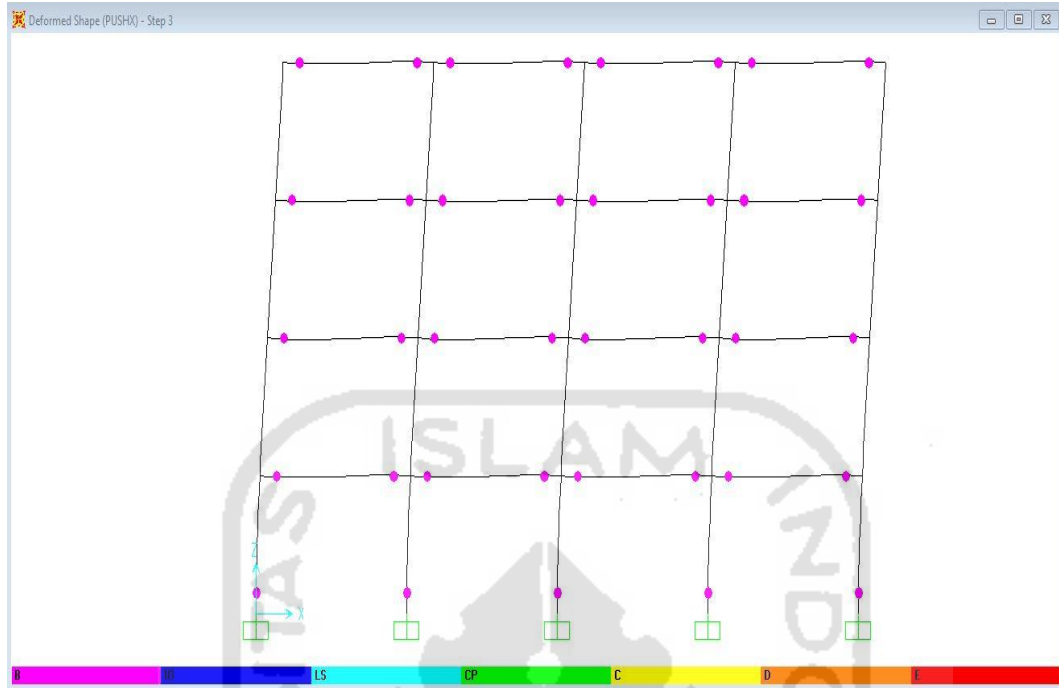

Lampiran 13. Sendi Plastis Arah X Gedung 1 pada Step-5 dan Step-6

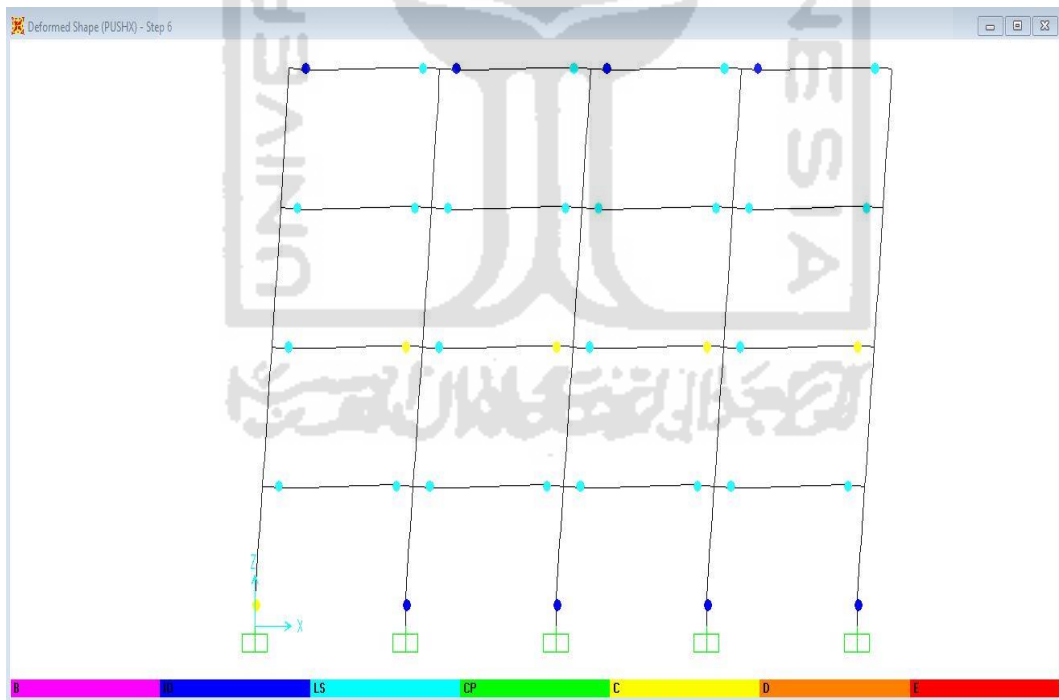
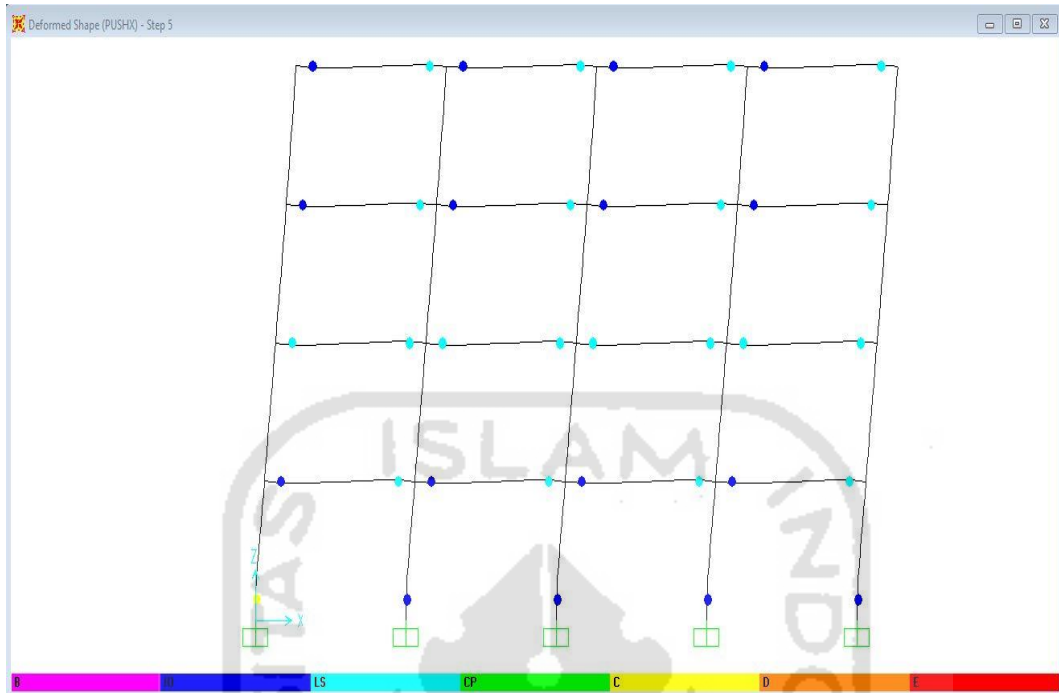

Lampiran 14. Sendi Plastis Arah X Gedung 1 pada Step-7 dan Step-8

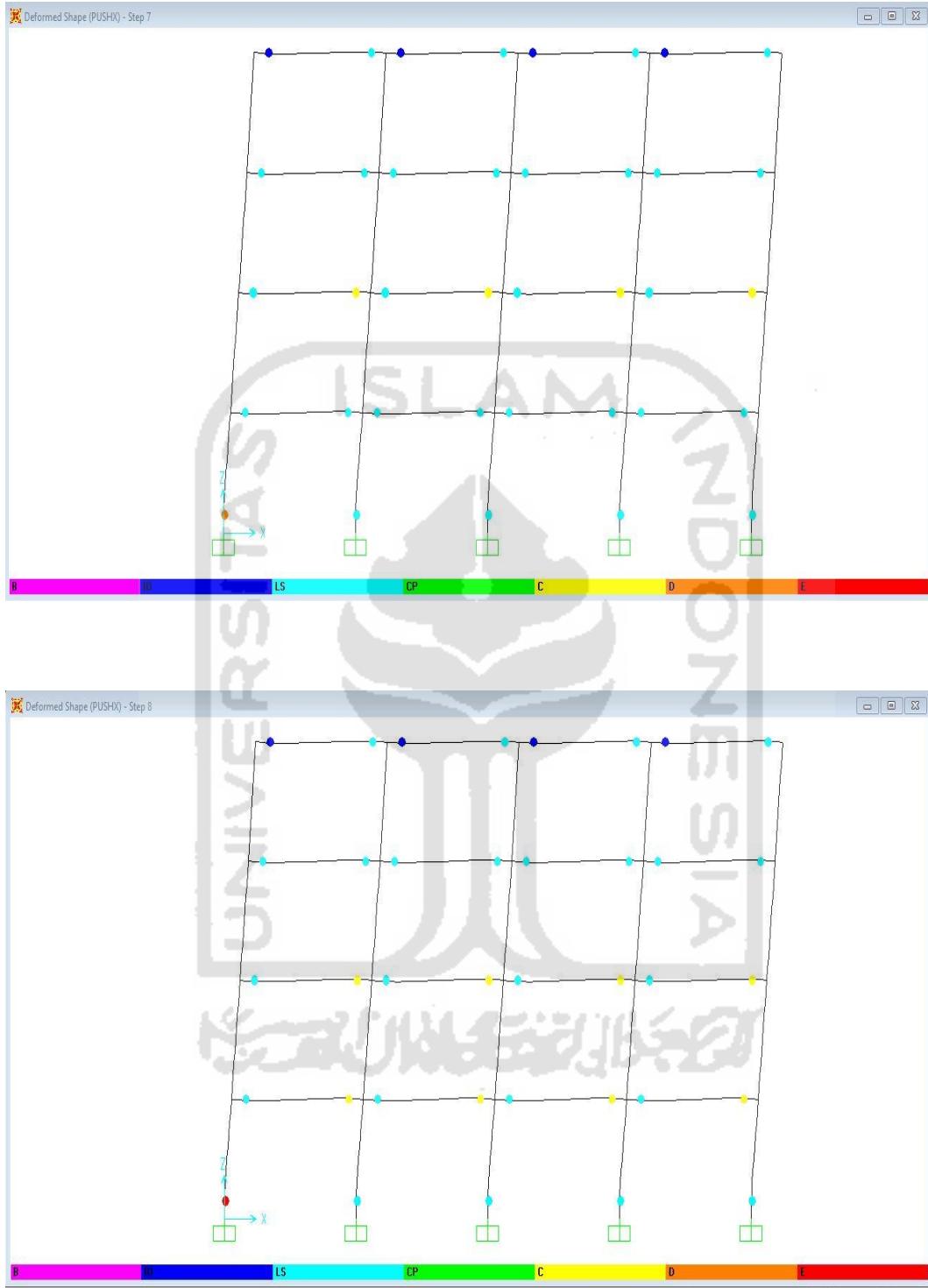

Lampiran 15. Sendi Plastis Arah Y Gedung 1 pada Step-1 dan Step-2

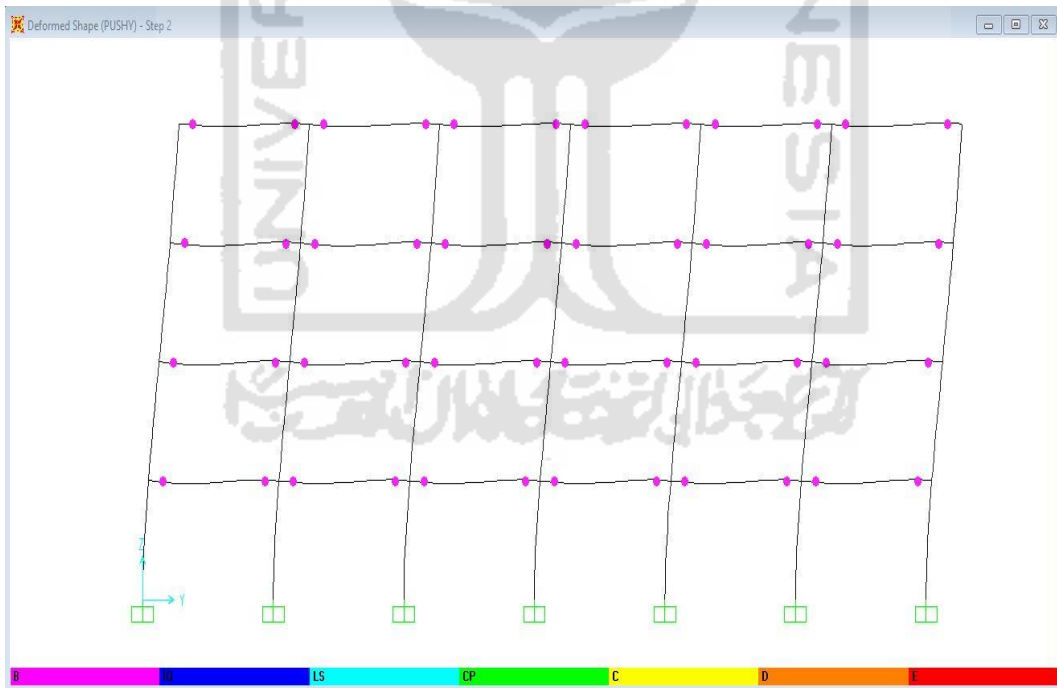
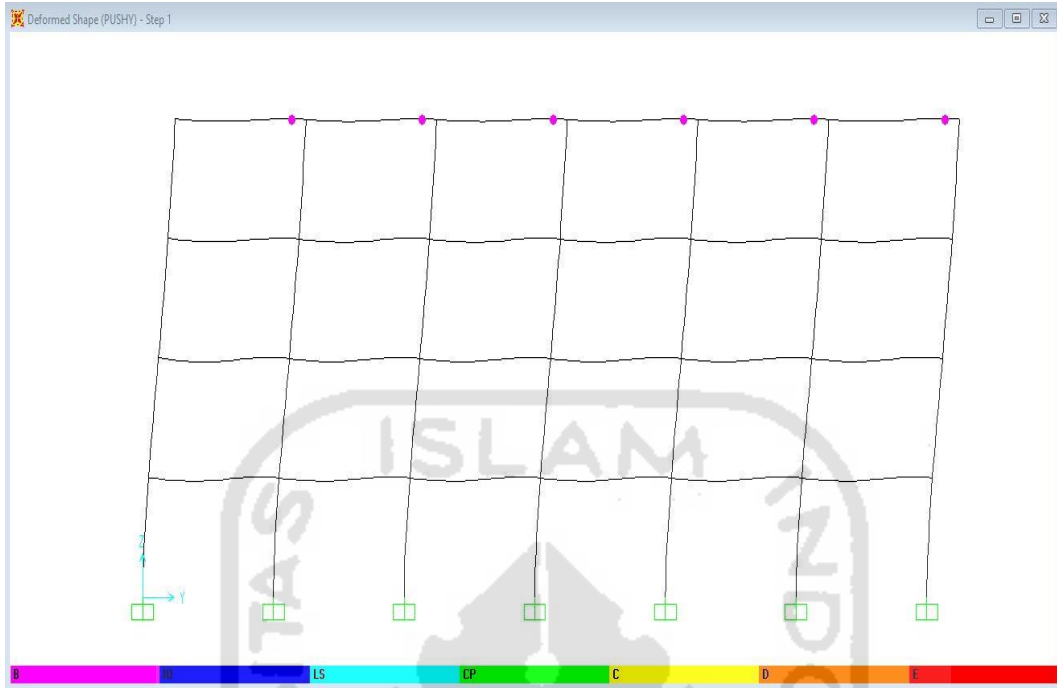

Lampiran 16. Sendi Plastis Arah Y Gedung 1 pada Step-3 dan Step-4

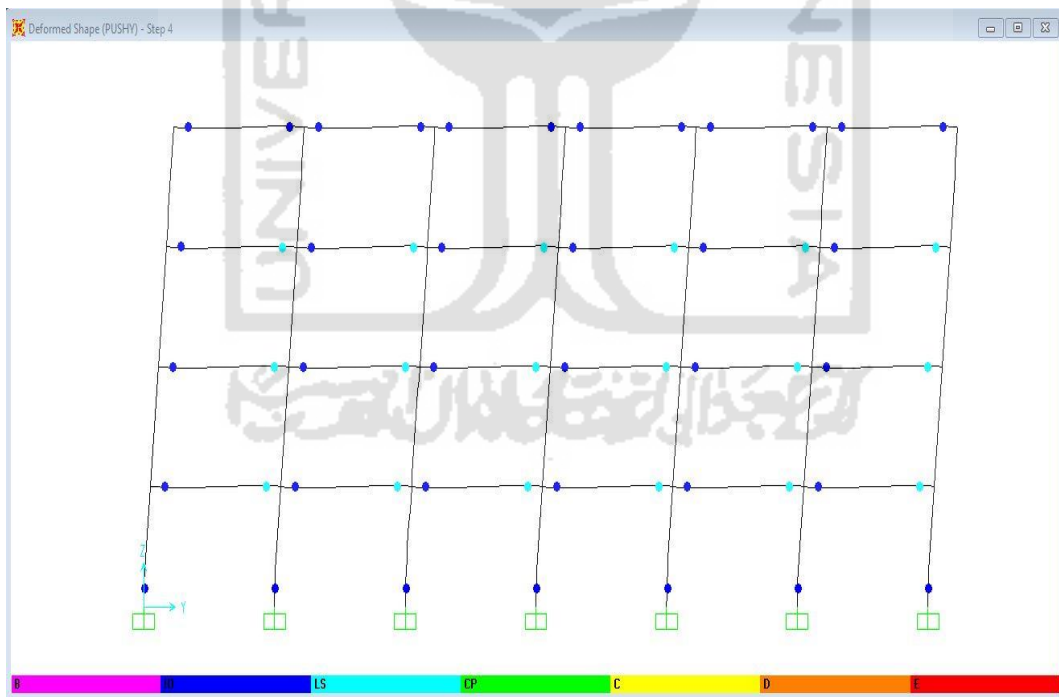
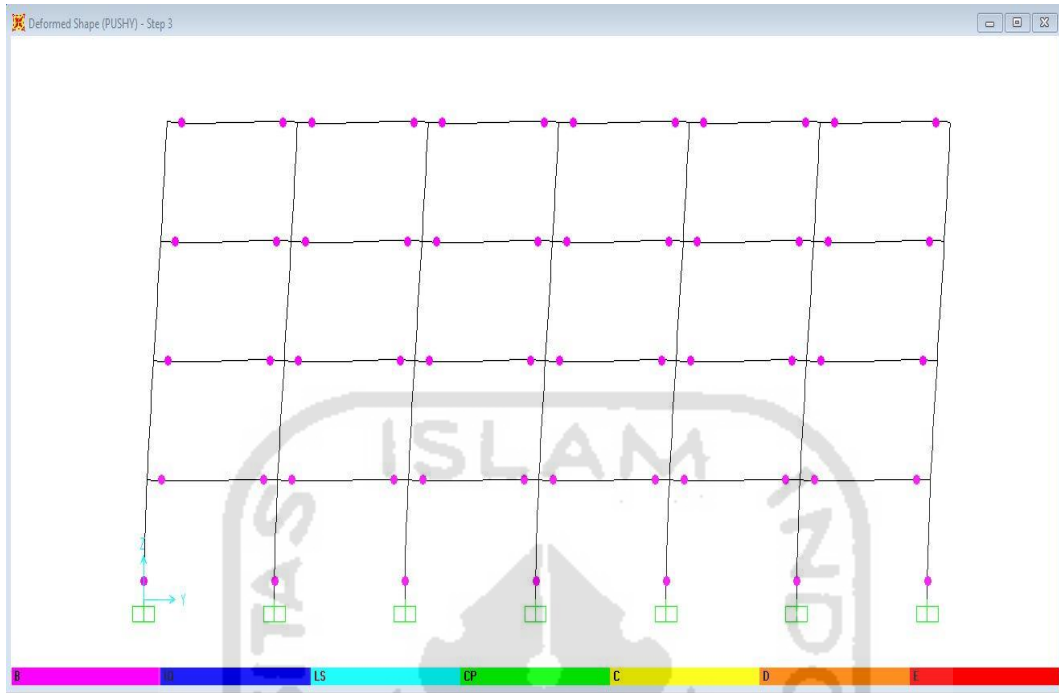

Lampiran 17. Sendi Plastis Arah Y Gedung 1 pada Step-5 dan Step-6

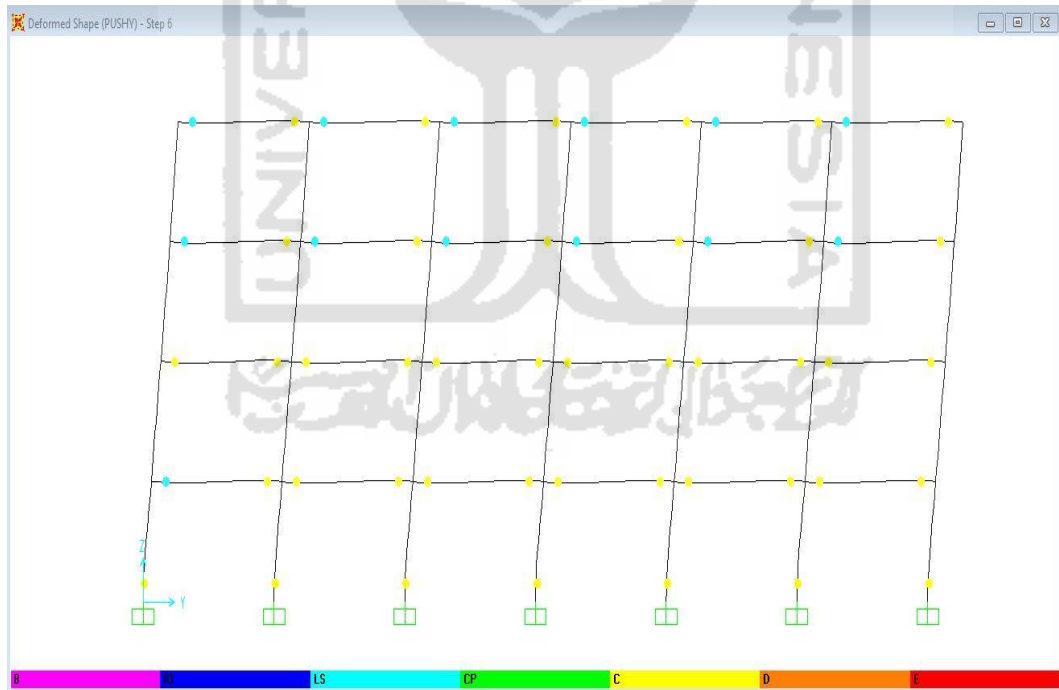
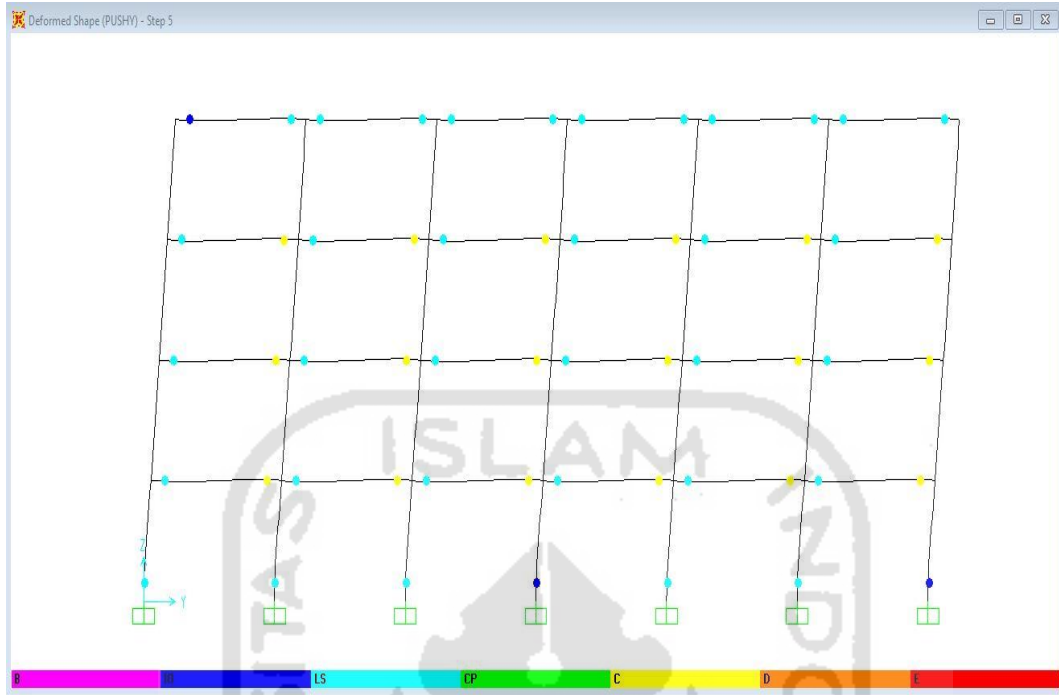

Lampiran 18. Sendi Plastis Arah X Gedung 2 pada Step-1 dan Step-2

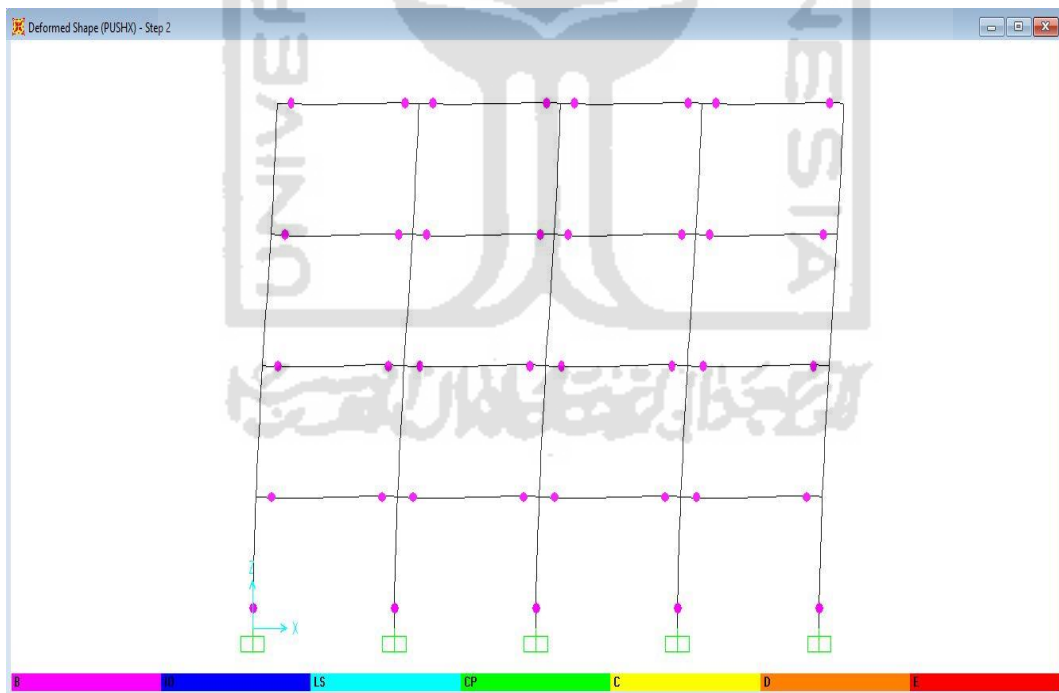
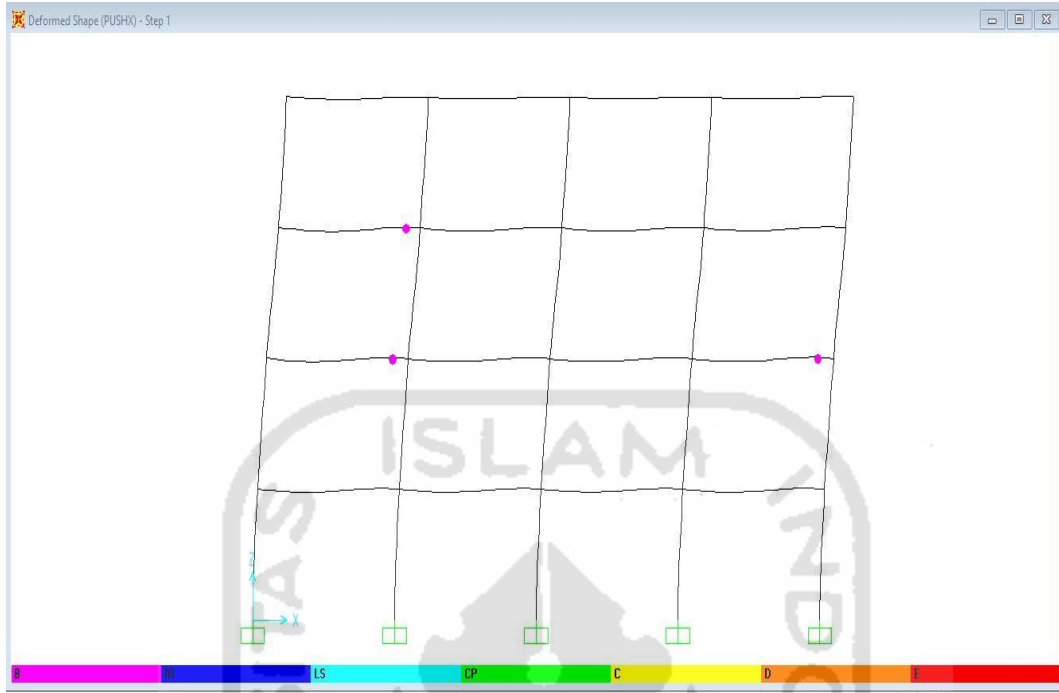

Lampiran 19. Sendi Plastis Arah X Gedung 2 pada Step-3 dan Step-4

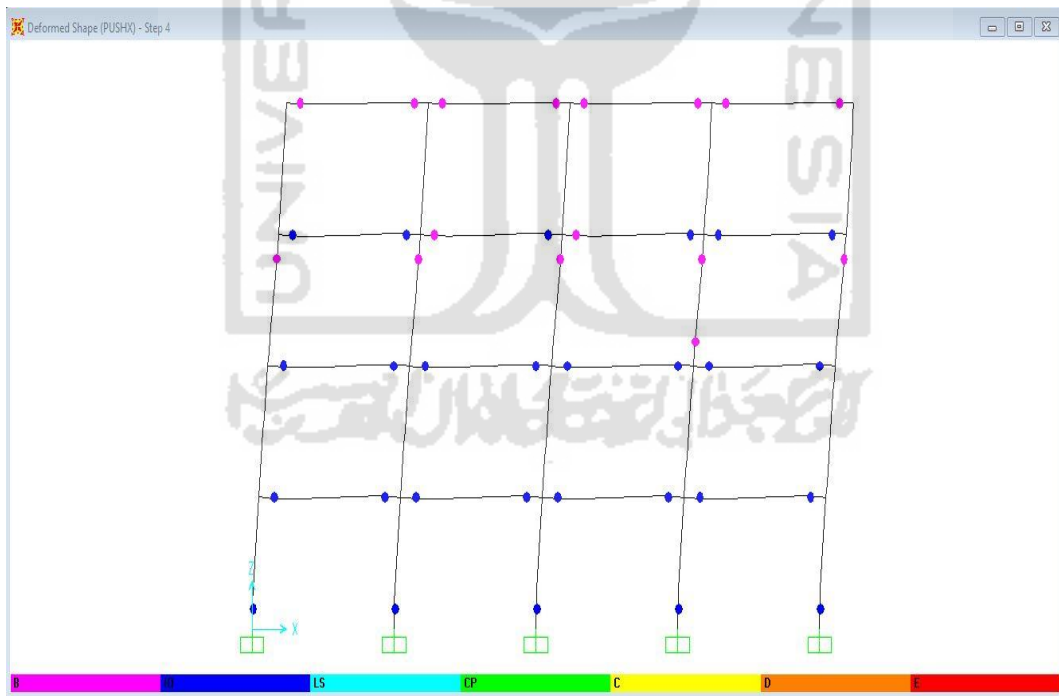
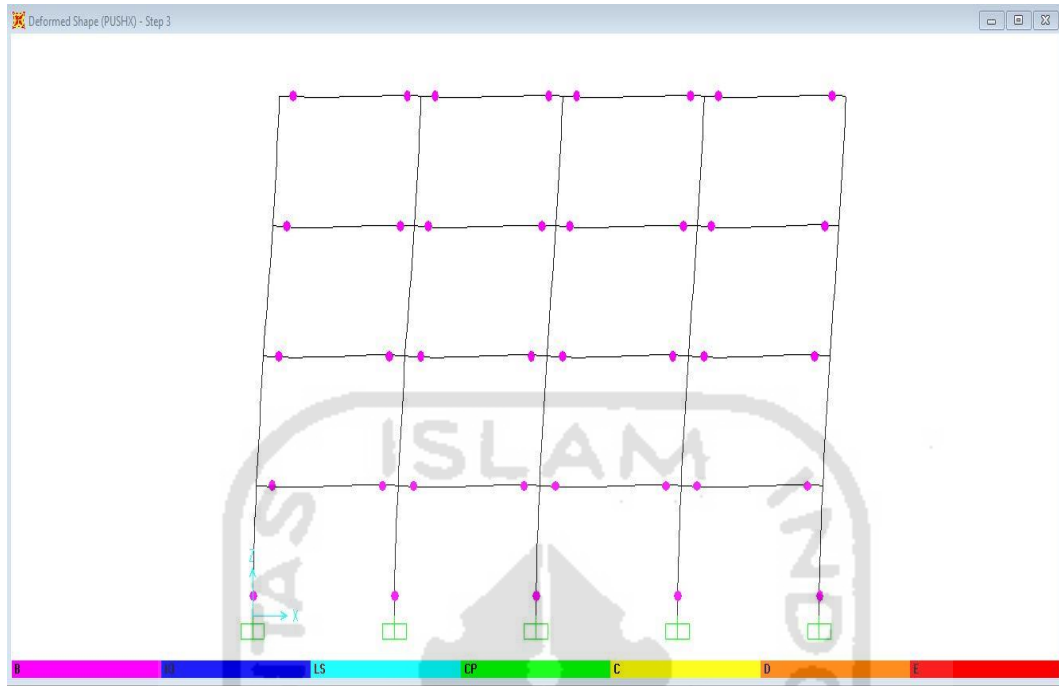

Lampiran 20. Sendi Plastis Arah X Gedung 2 pada Step-5 dan Step-6

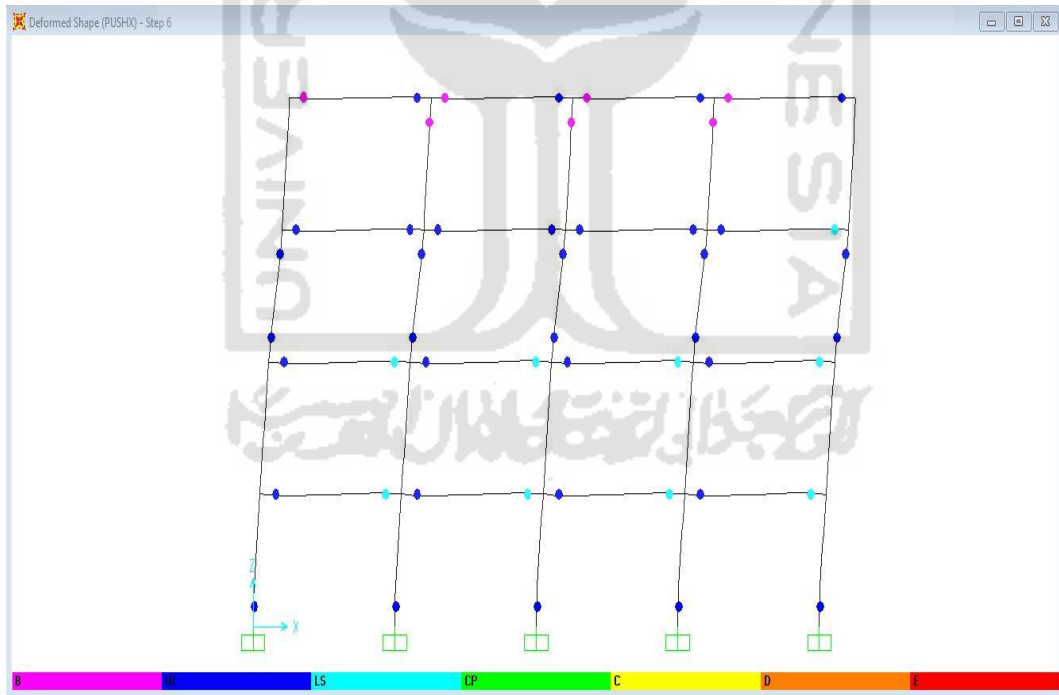
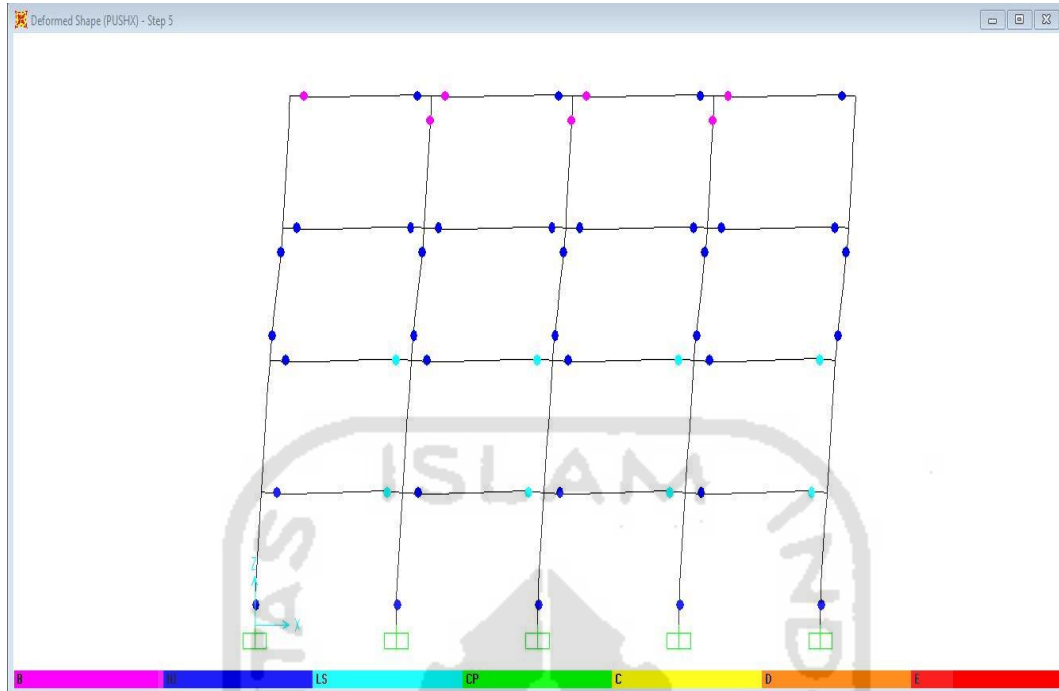

Lampiran 21. Sendi Plastis Arah X Gedung 2 pada Step-7 dan Step-8

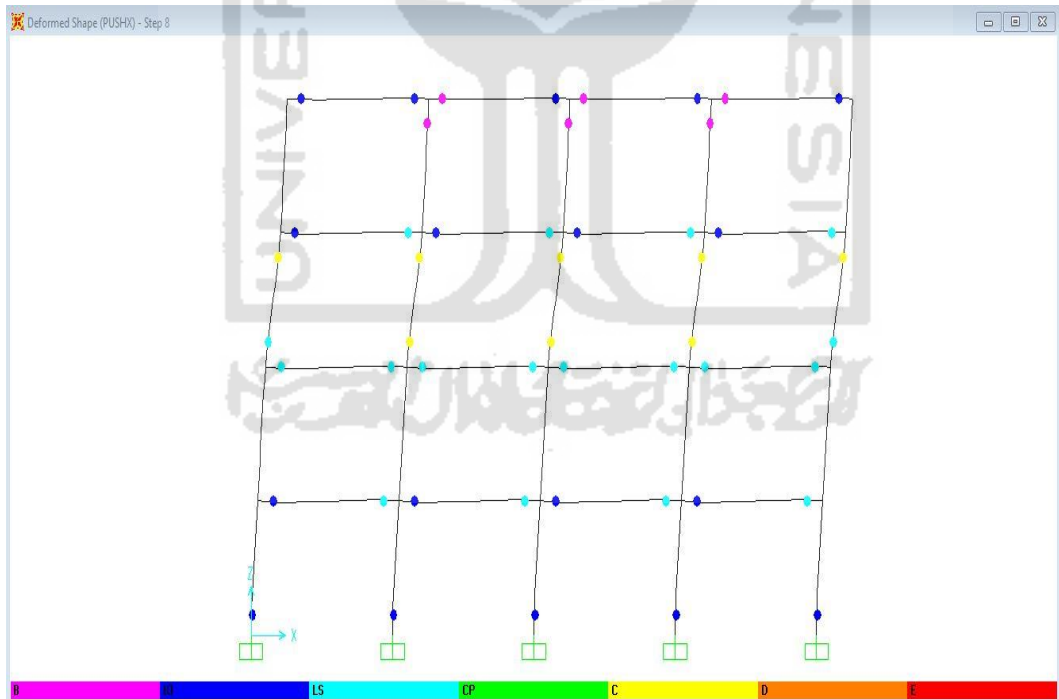
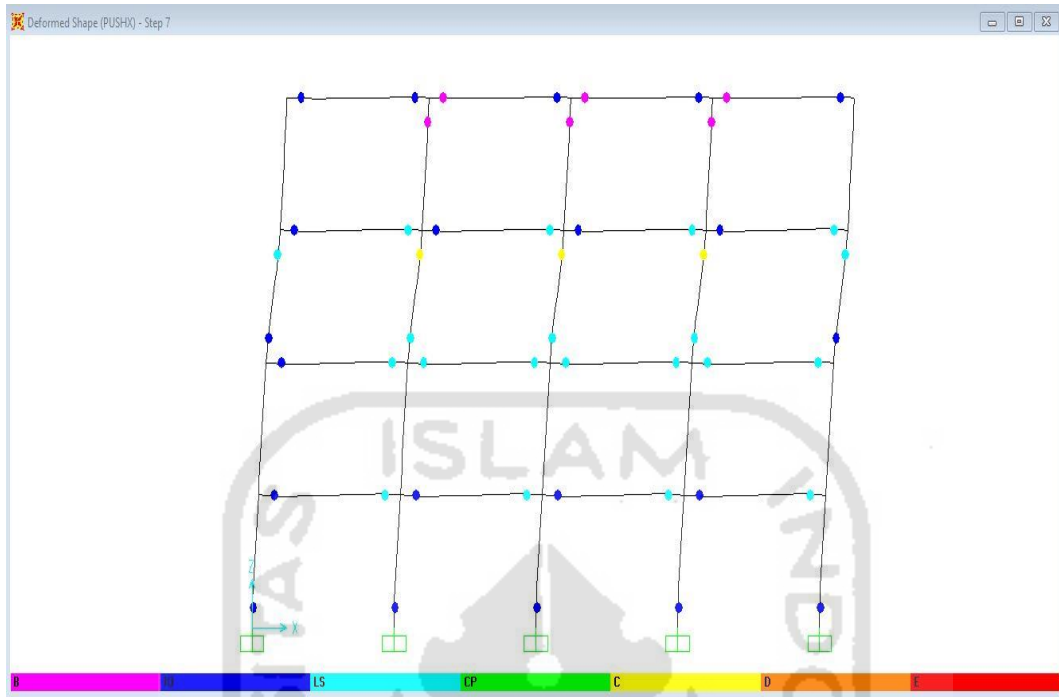

Lampiran 22. Sendi Plastis Arah X Gedung 2 pada Step-9 dan Step-10

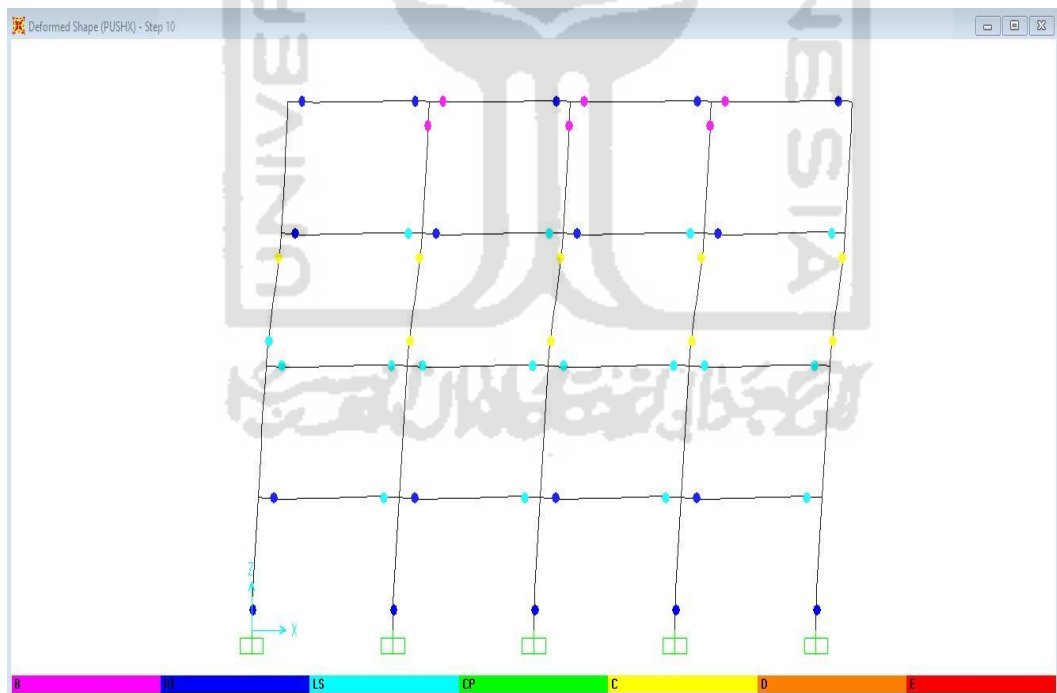
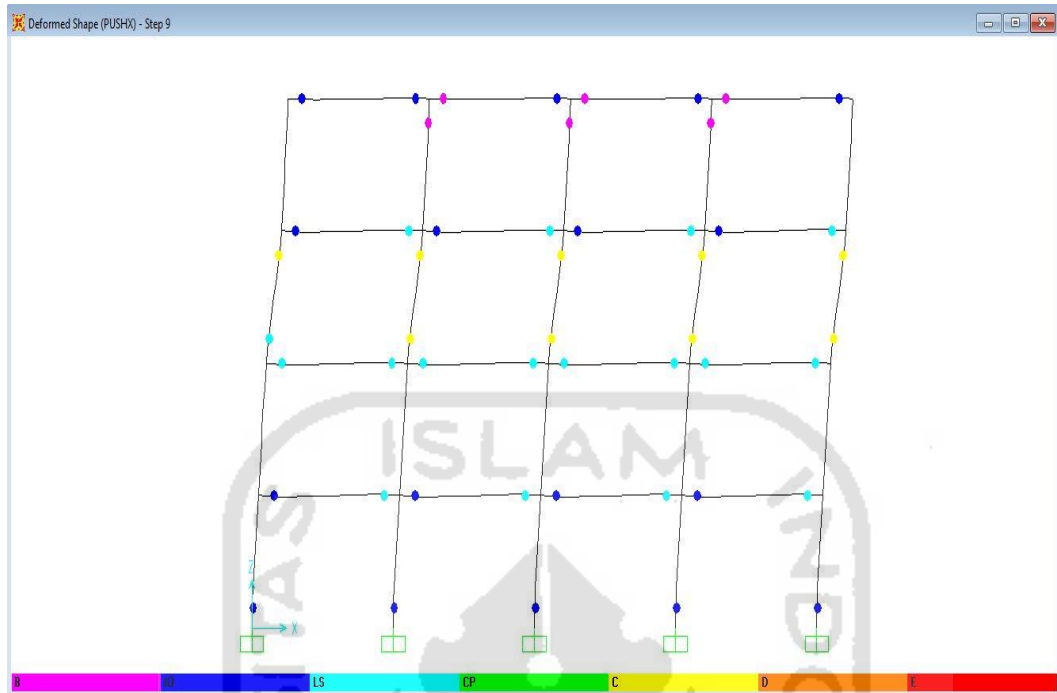

Lampiran 23. Sendi Plastis Arah X Gedung 2 pada Step-11 dan Step-12

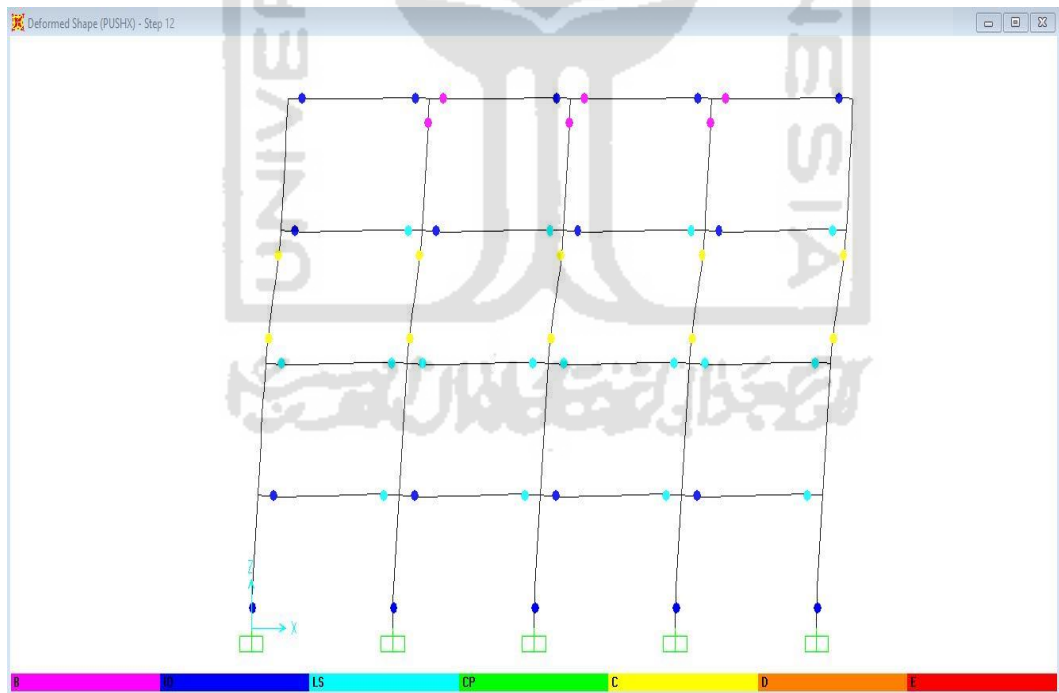
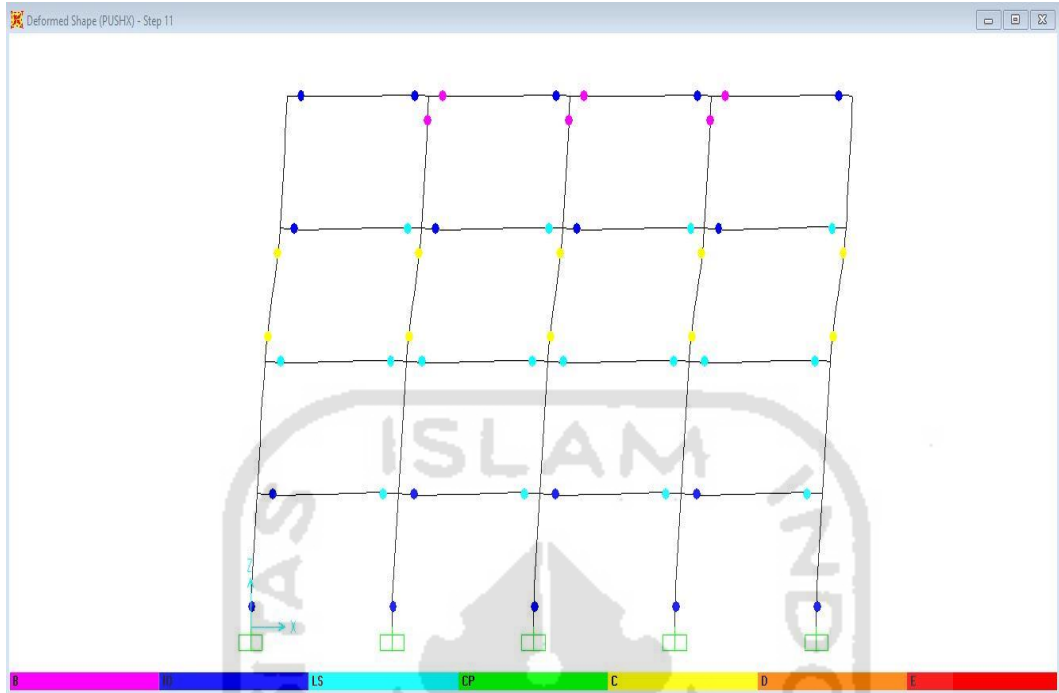

Lampiran 24. Sendi Plastis Arah X Gedung 2 pada Step-13 dan Step-14

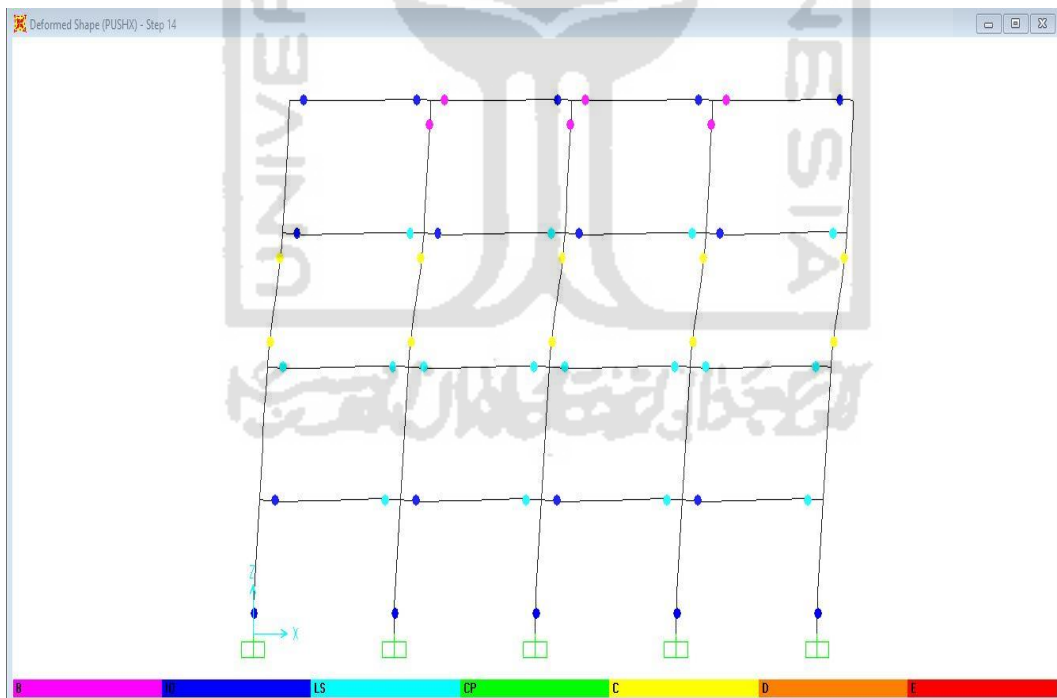
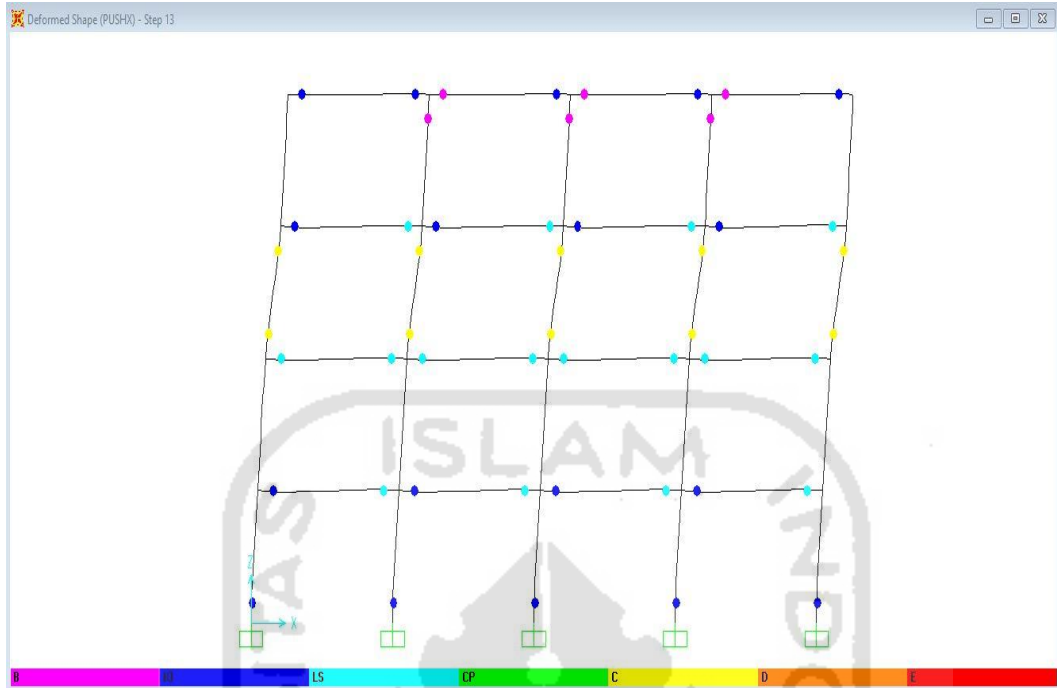

Lampiran 25. Sendi Plastis Arah X Gedung 2 pada Step-15 dan Step-16

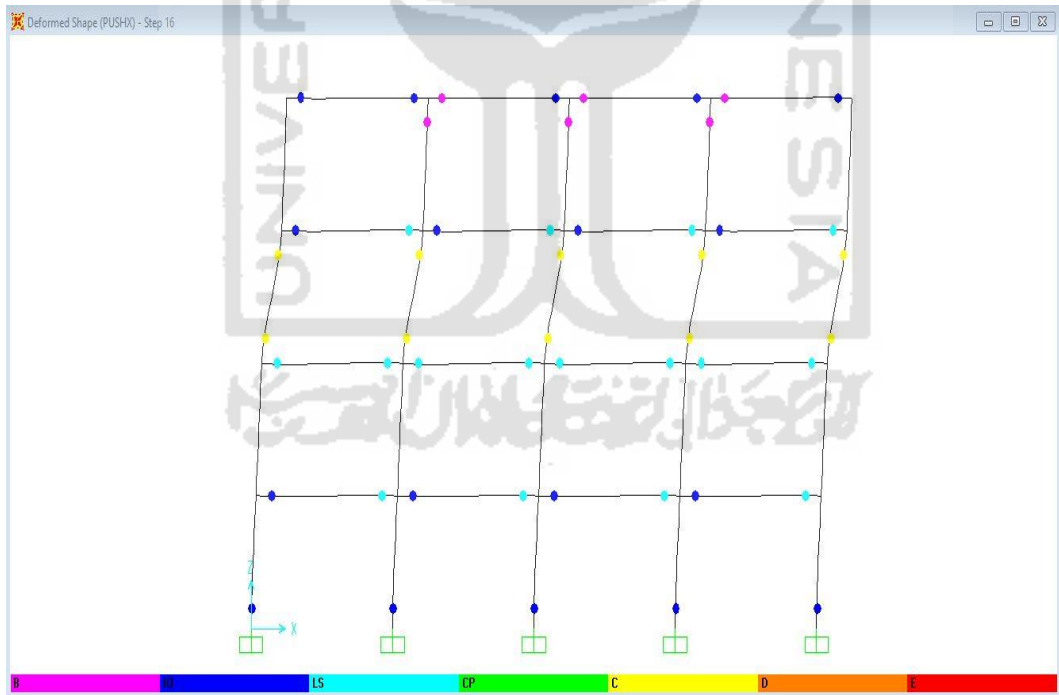
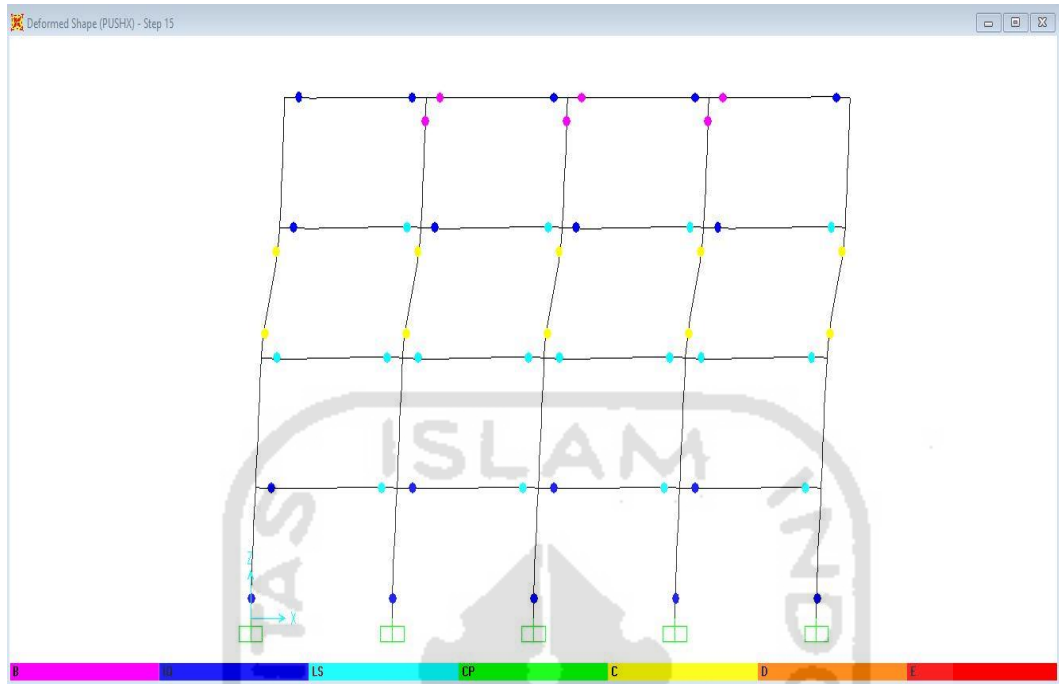

Lampiran 26. Sendi Plastis Arah X Gedung 2 pada Step-17 dan Step-18

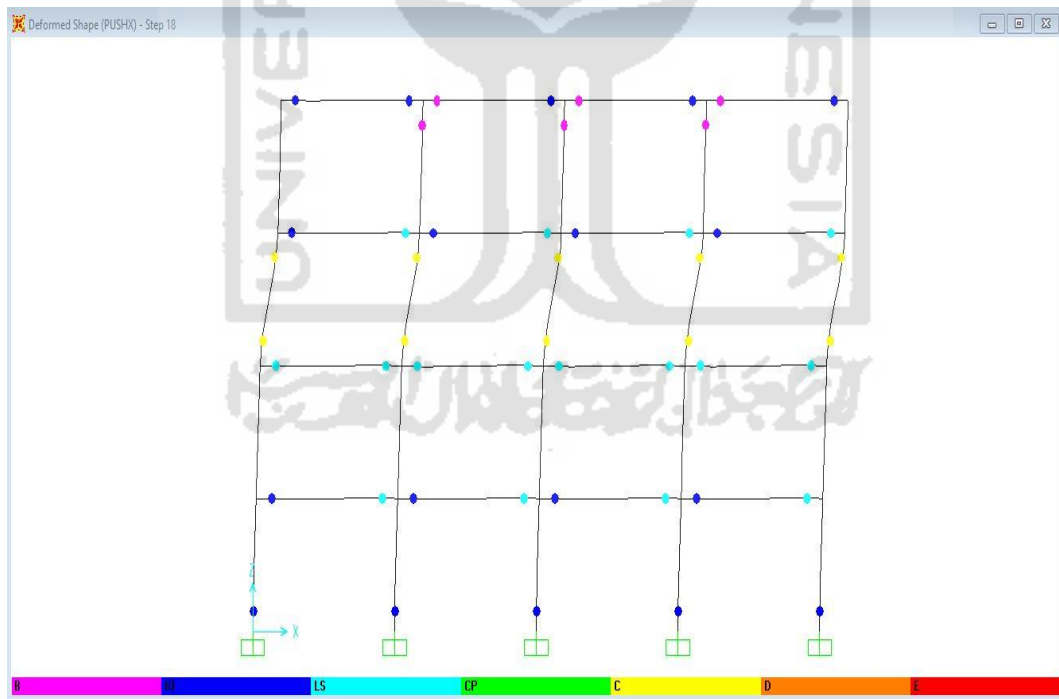
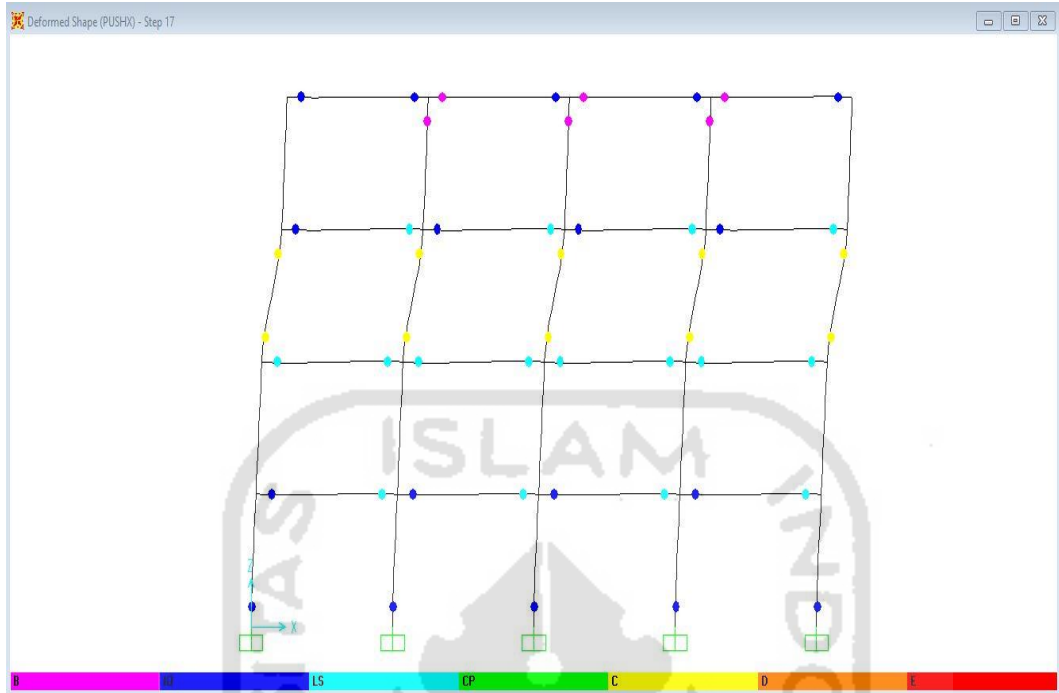

Lampiran 27. Sendi Plastis Arah X Gedung 2 pada Step-19 dan Step-20

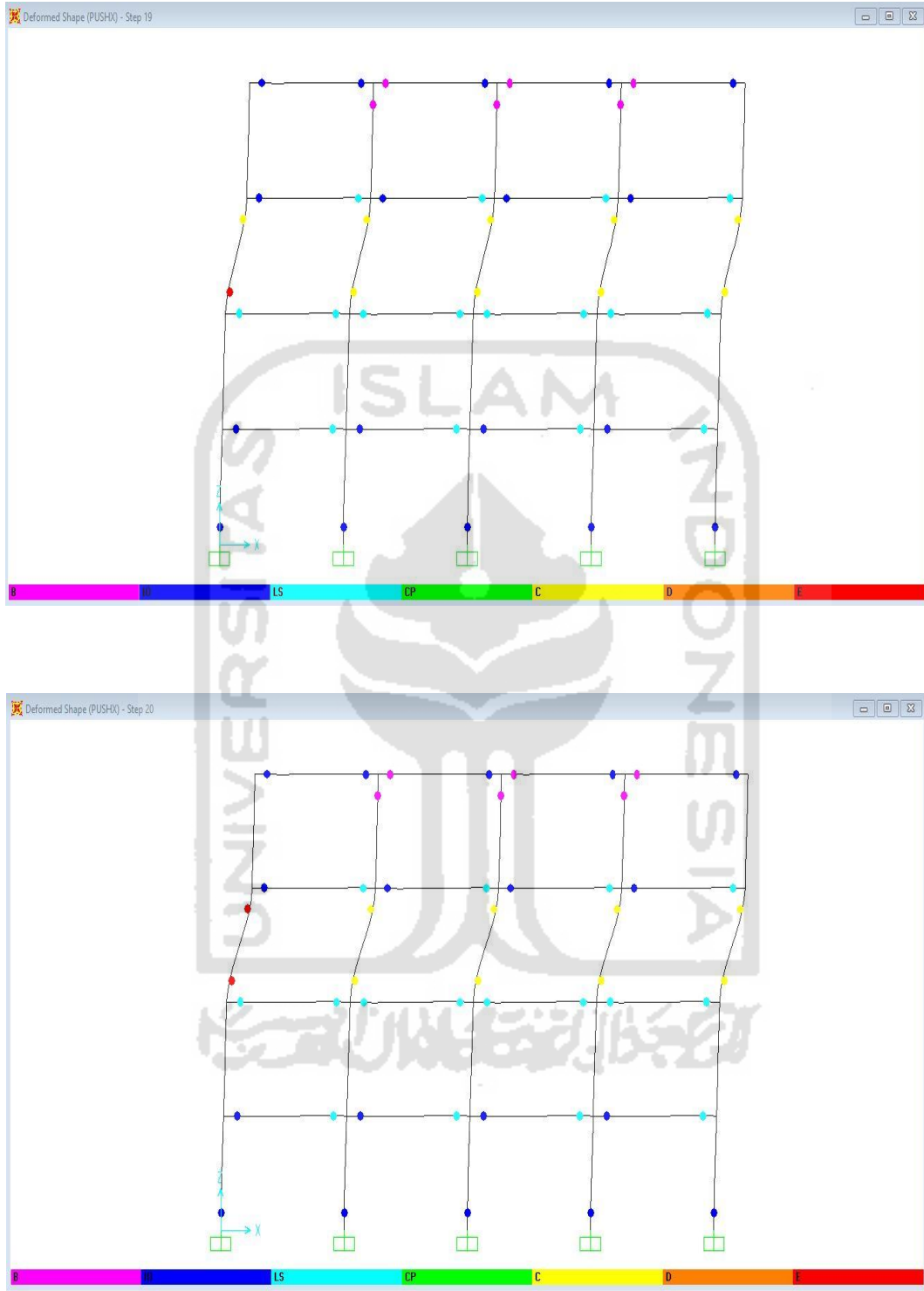

Lampiran 28. Sendi Plastis Arah X Gedung 2 pada Step-21 dan Step-22

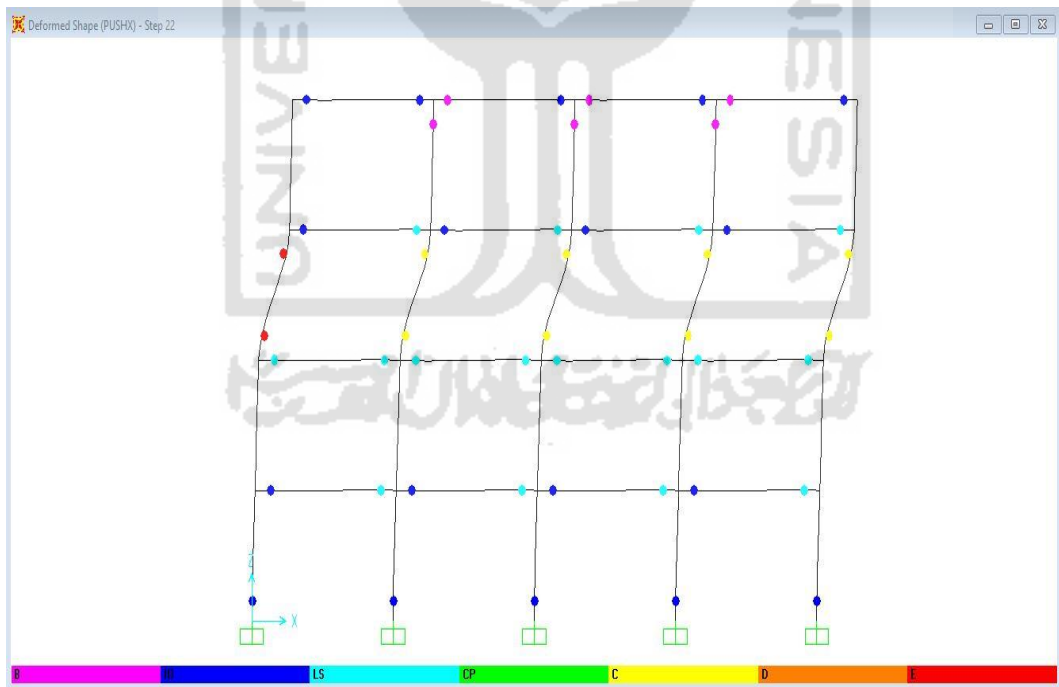
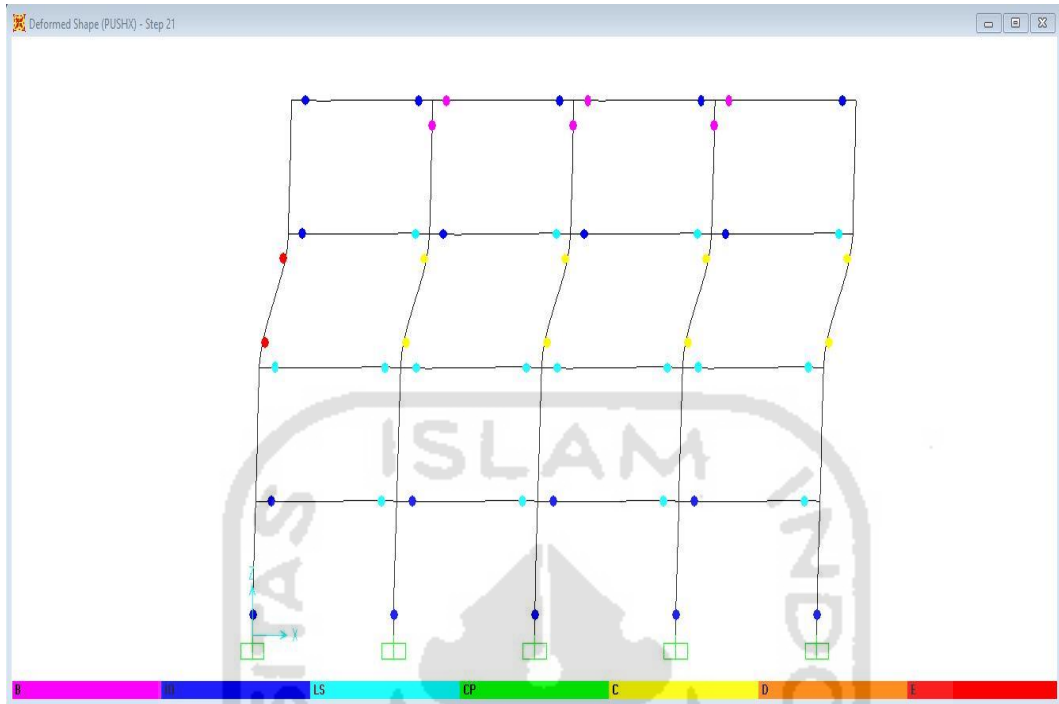

Lampiran 29. Sendi Plastis Arah X Gedung 2 pada Step-23 dan Step-24

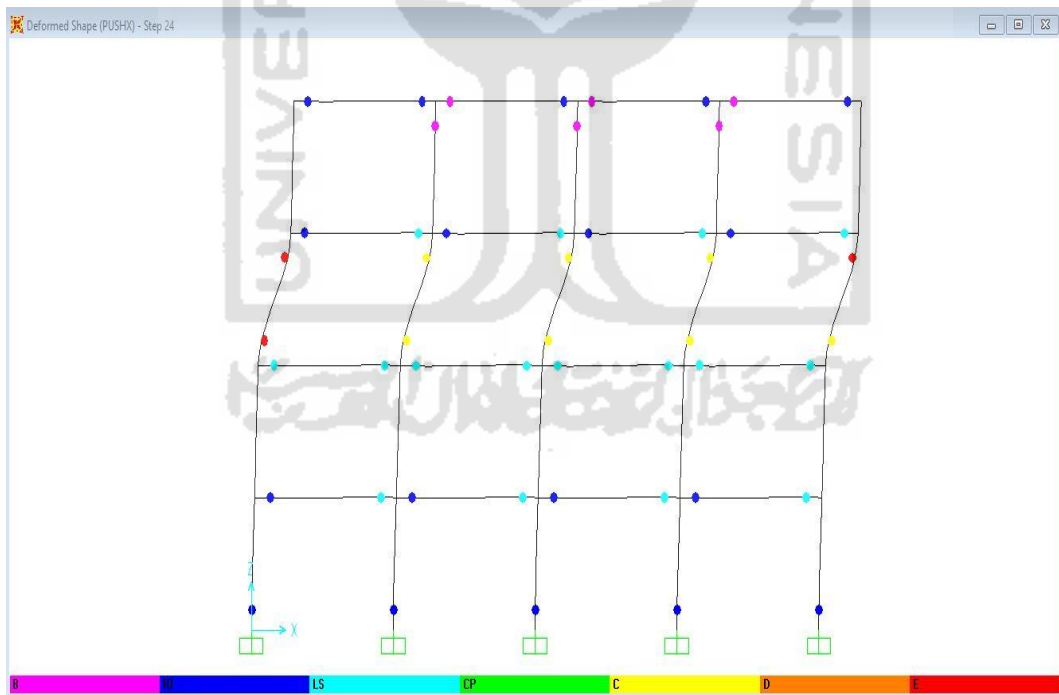
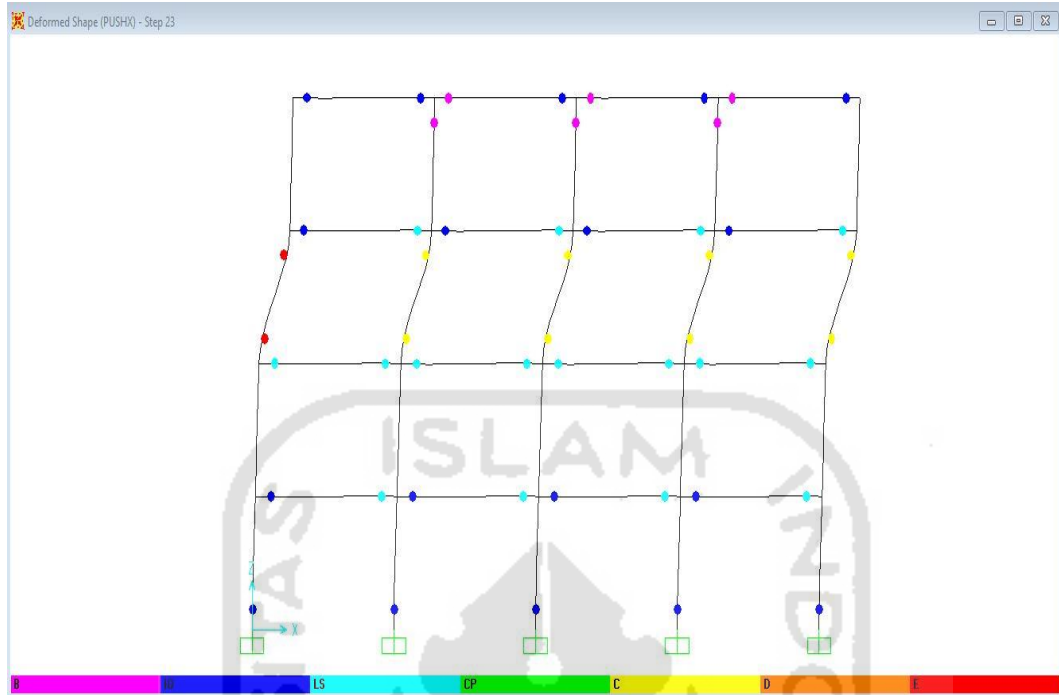

Lampiran 30. Sendi Plastis Arah X Gedung 2 pada Step-25 dan Step-26

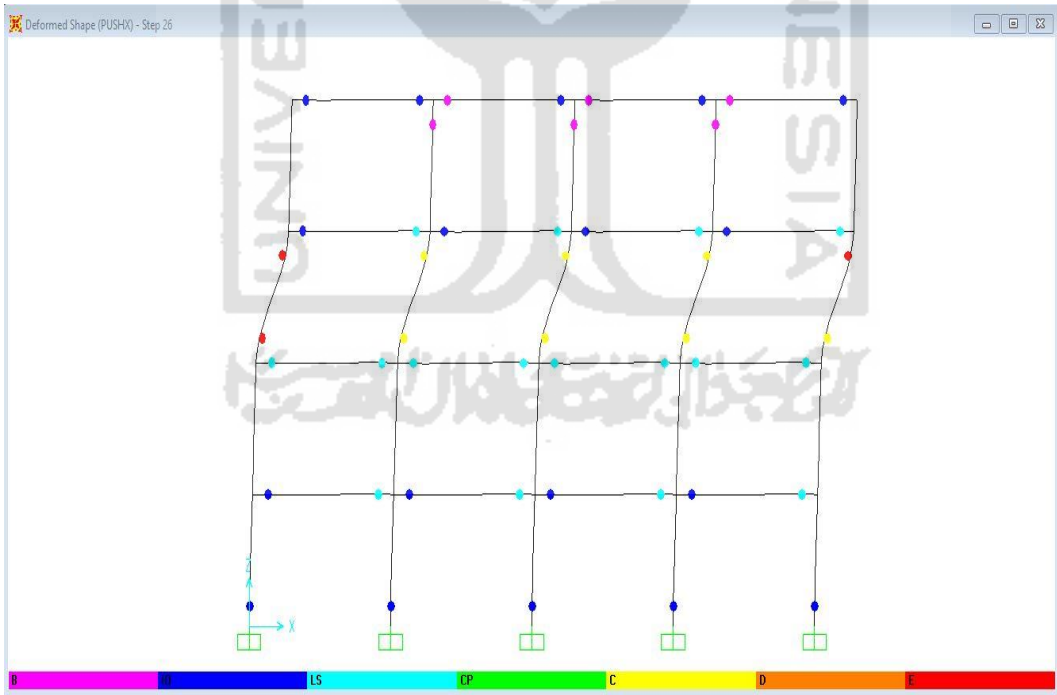
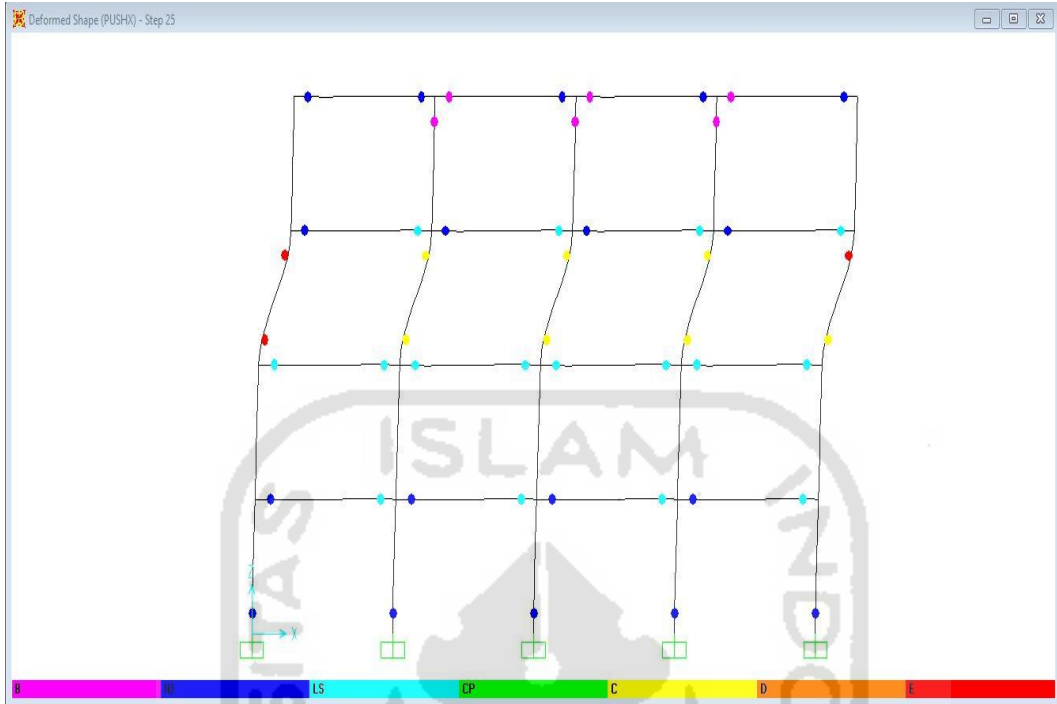

Lampiran 31. Sendi Plastis Arah Y Gedung 2 pada Step-1 dan Step-2

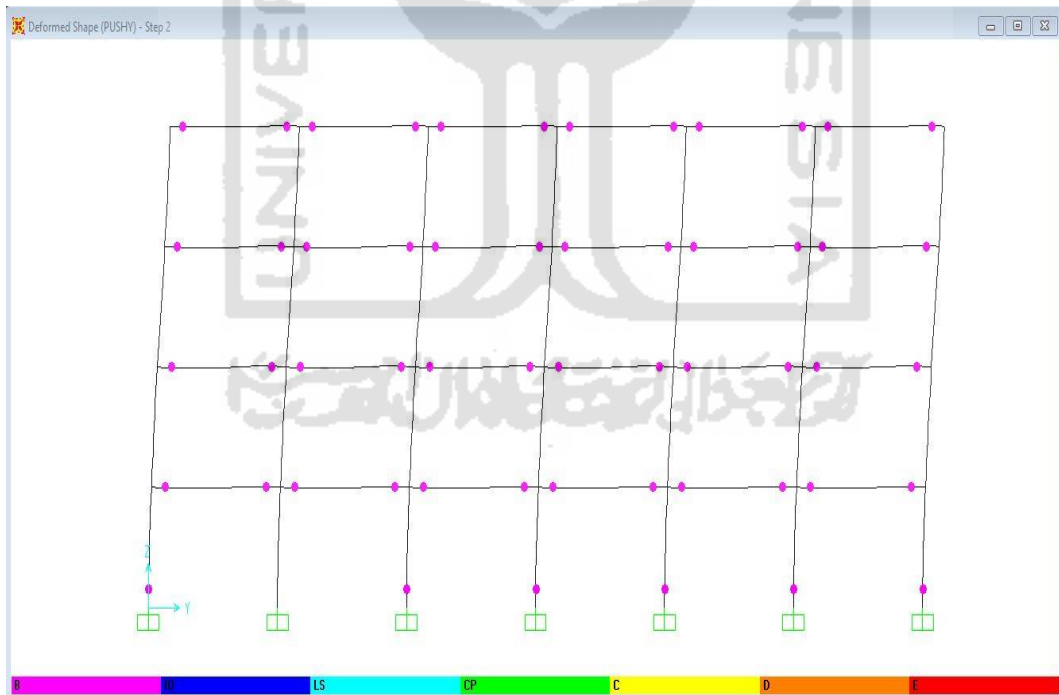
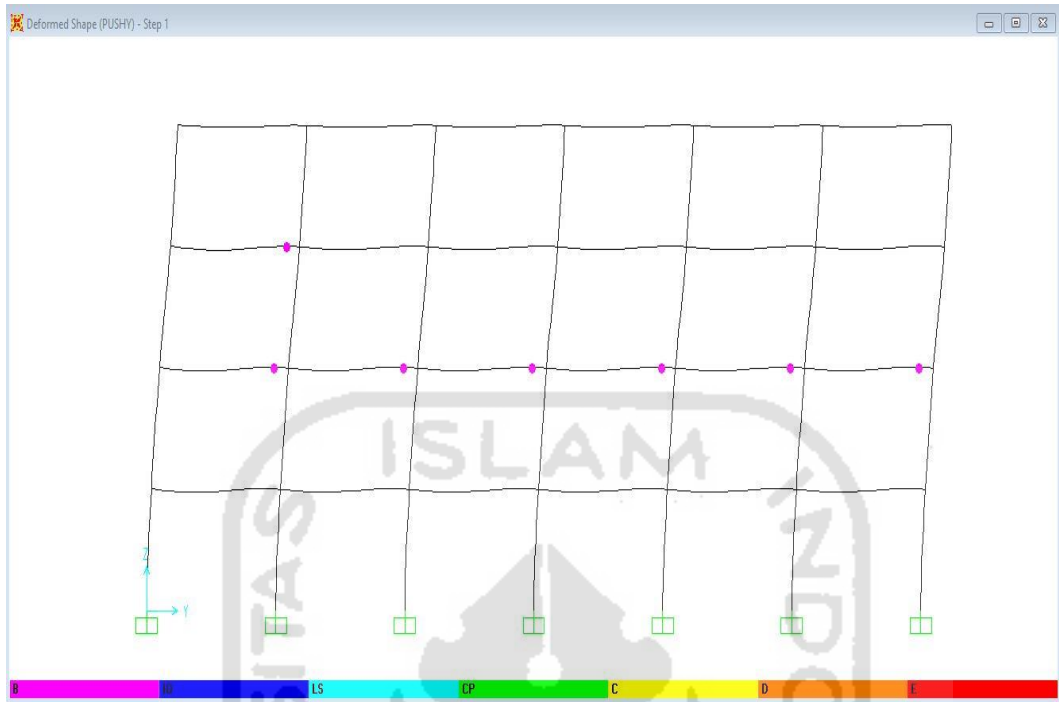

Lampiran 32. Sendi Plastis Arah Y Gedung 2 pada Step-3 dan Step-4

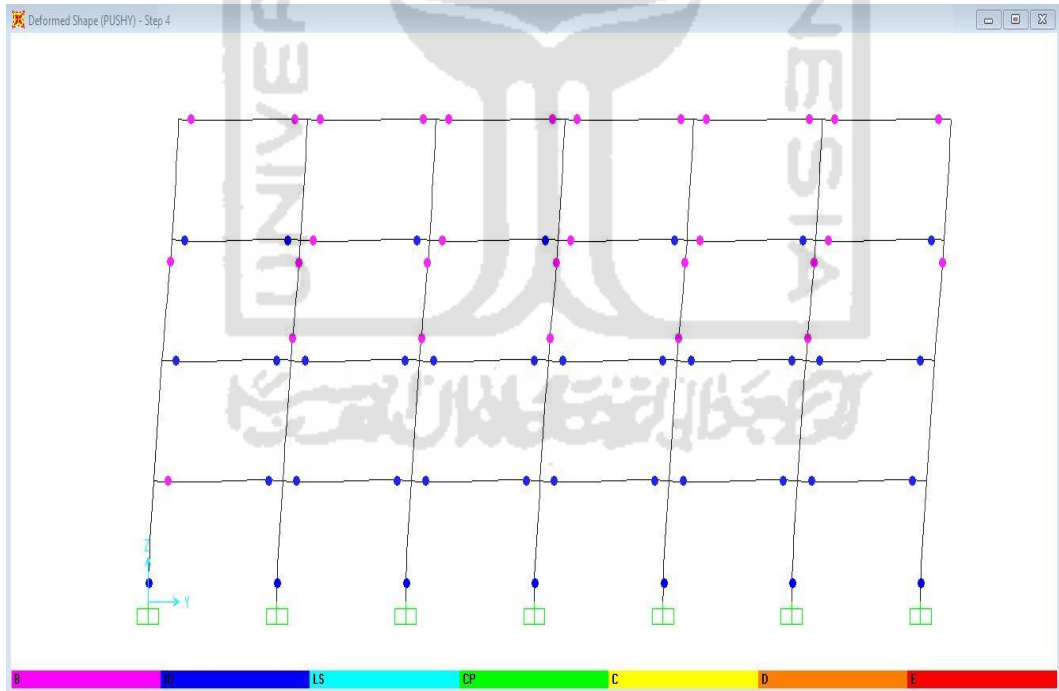
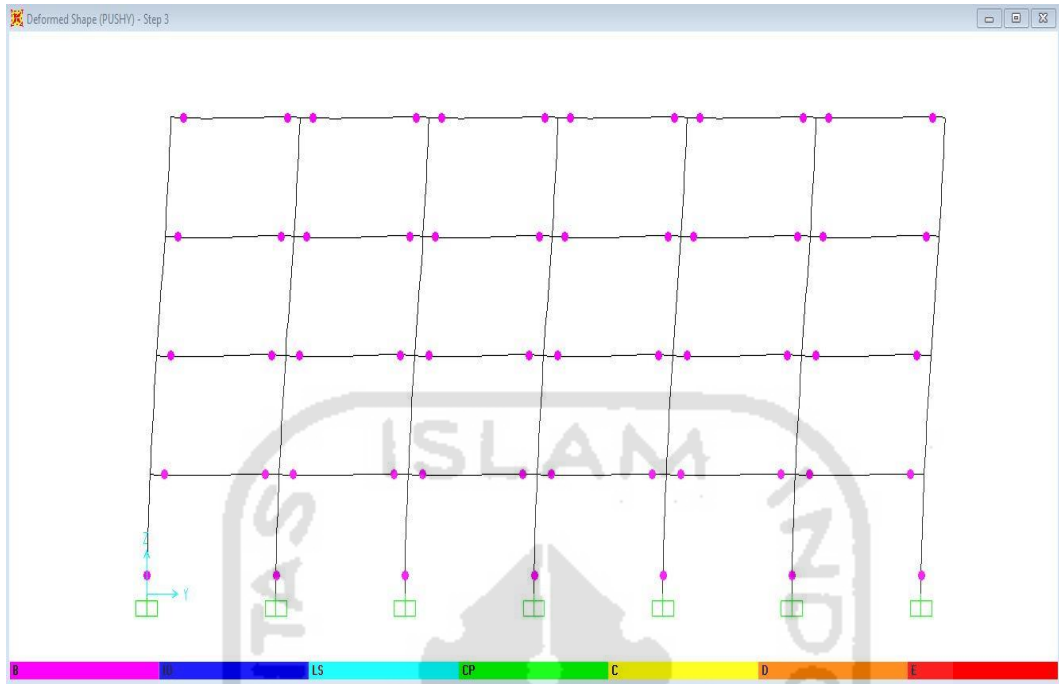

Lampiran 33. Sendi Plastis Arah Y Gedung 2 pada Step-5 dan Step-6

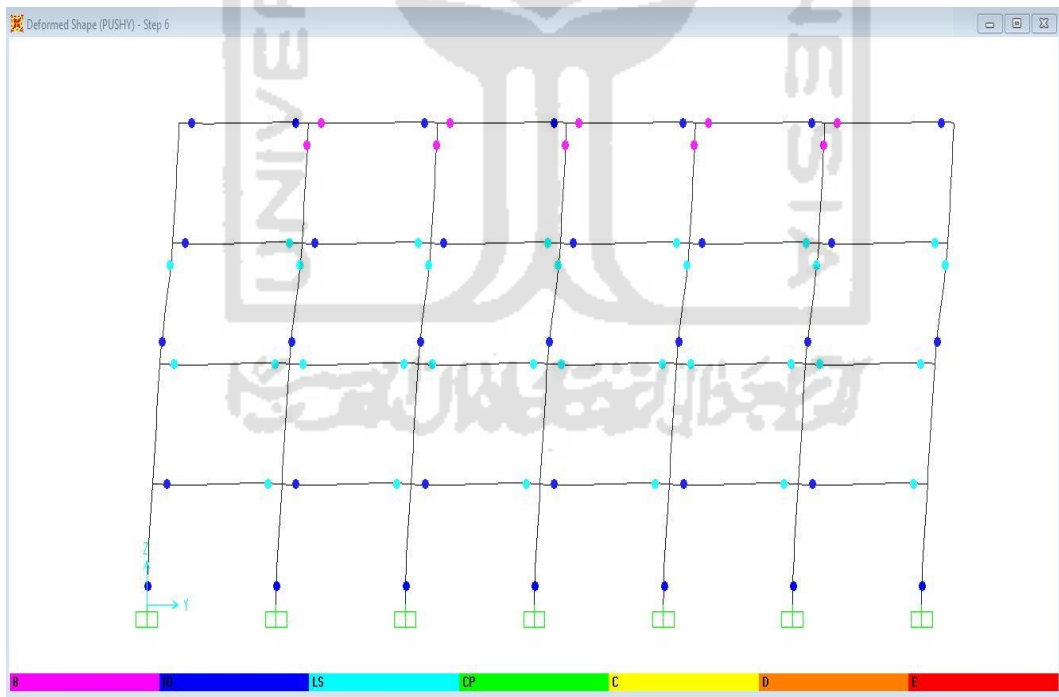
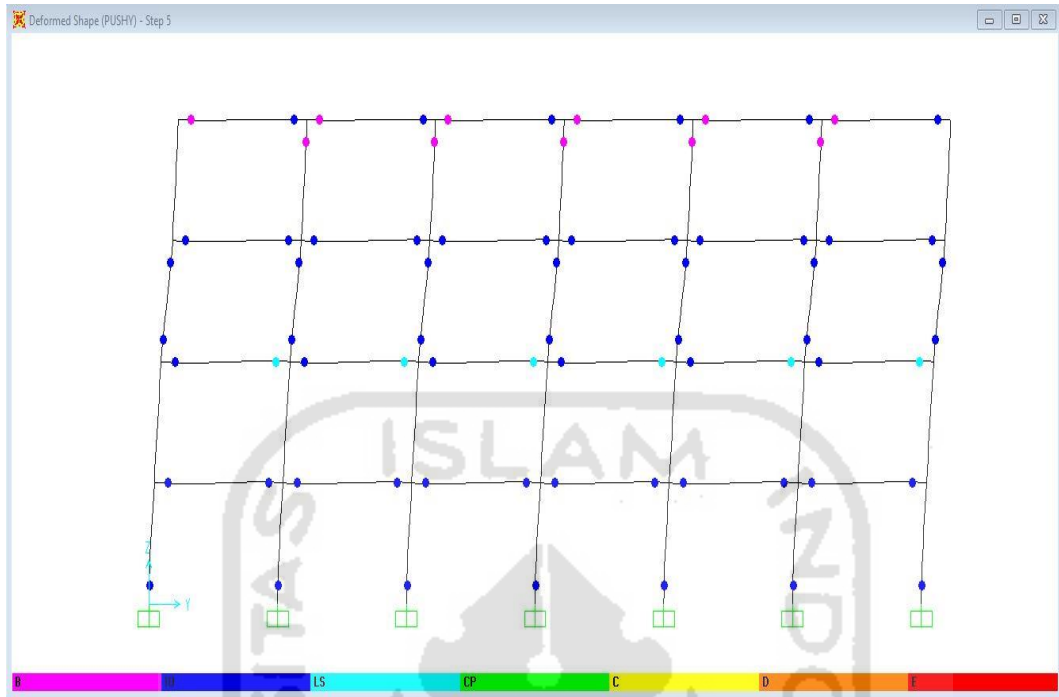

Lampiran 34. Sendi Plastis Arah Y Gedung 2 pada Step-7 dan Step-8

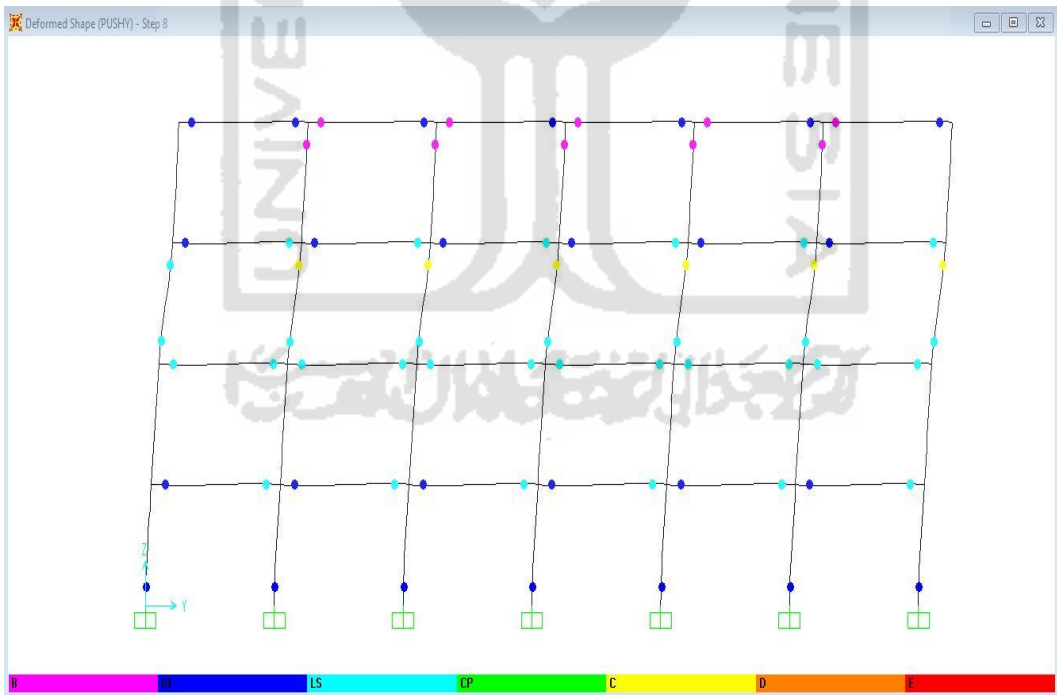
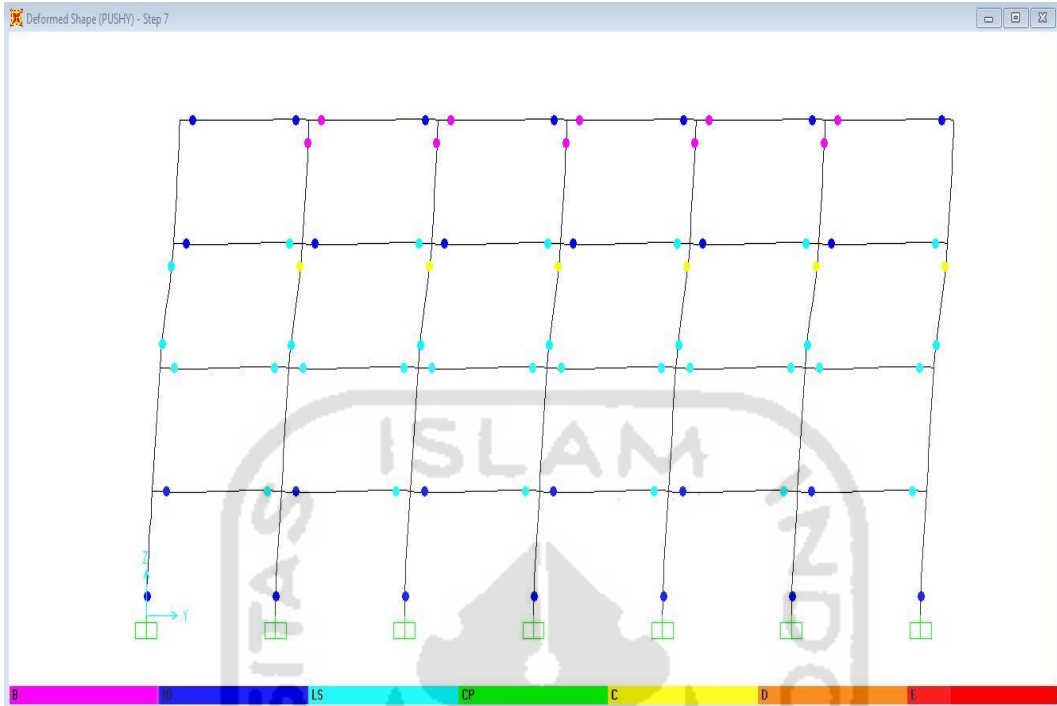

Lampiran 35. Sendi Plastis Arah Y Gedung 2 pada Step-9 dan Step-10

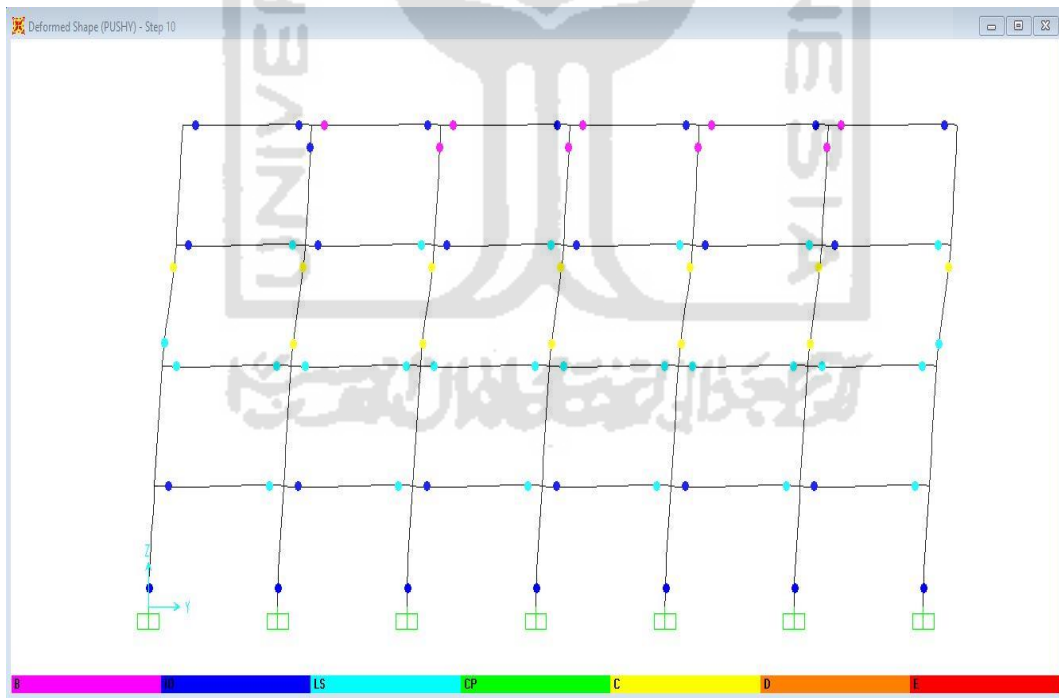
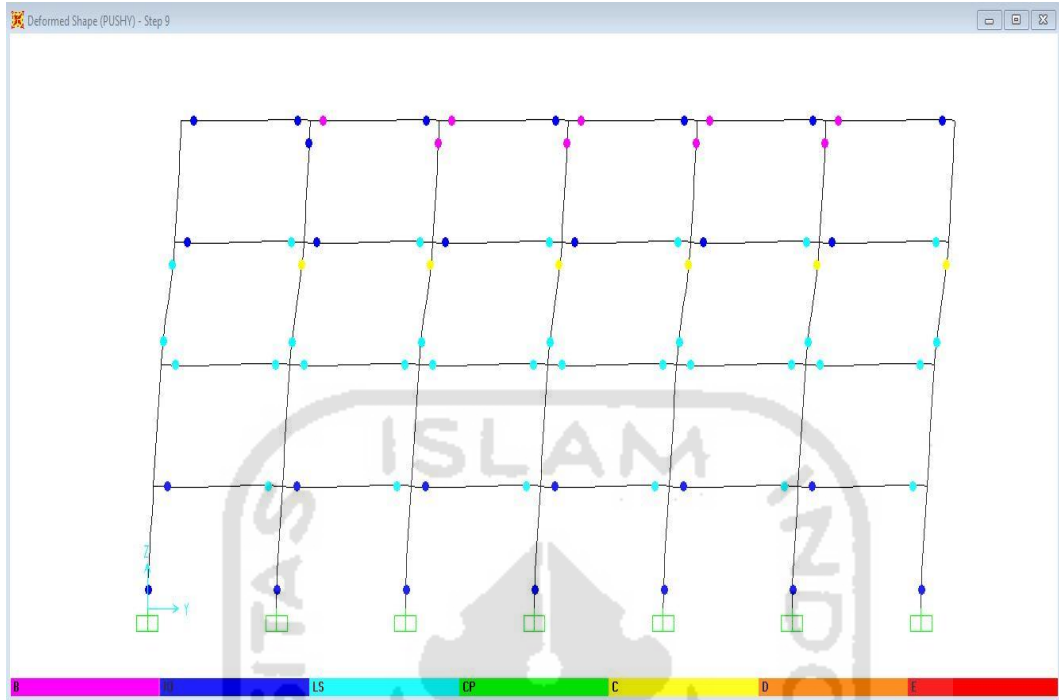

Lampiran 36. Sendi Plastis Arah Y Gedung 2 pada Step-11 dan Step-12

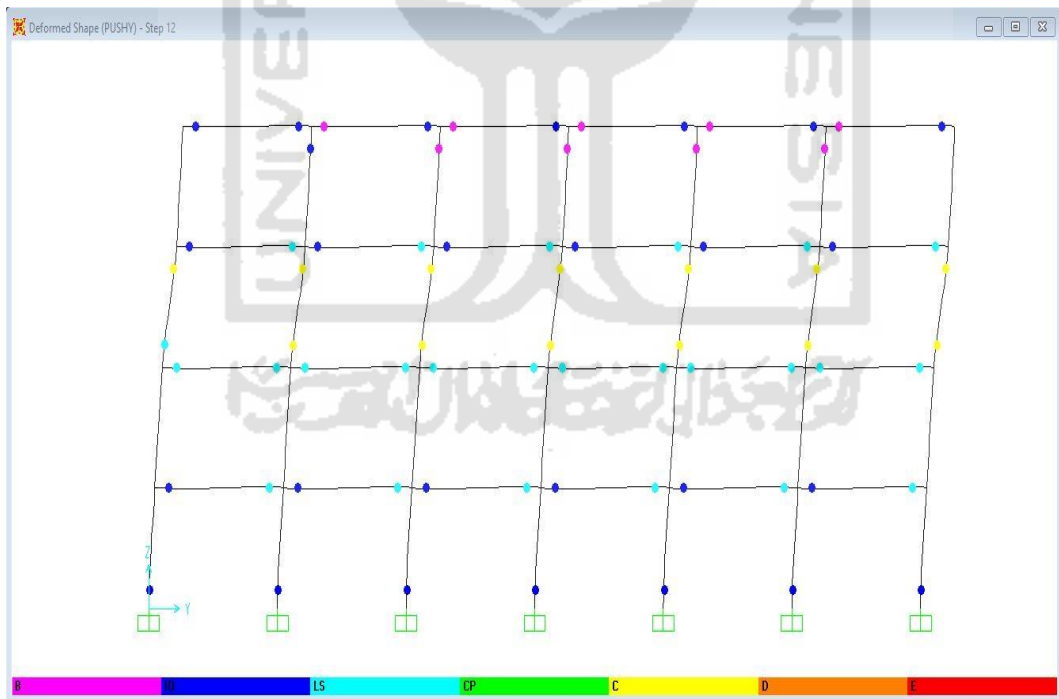
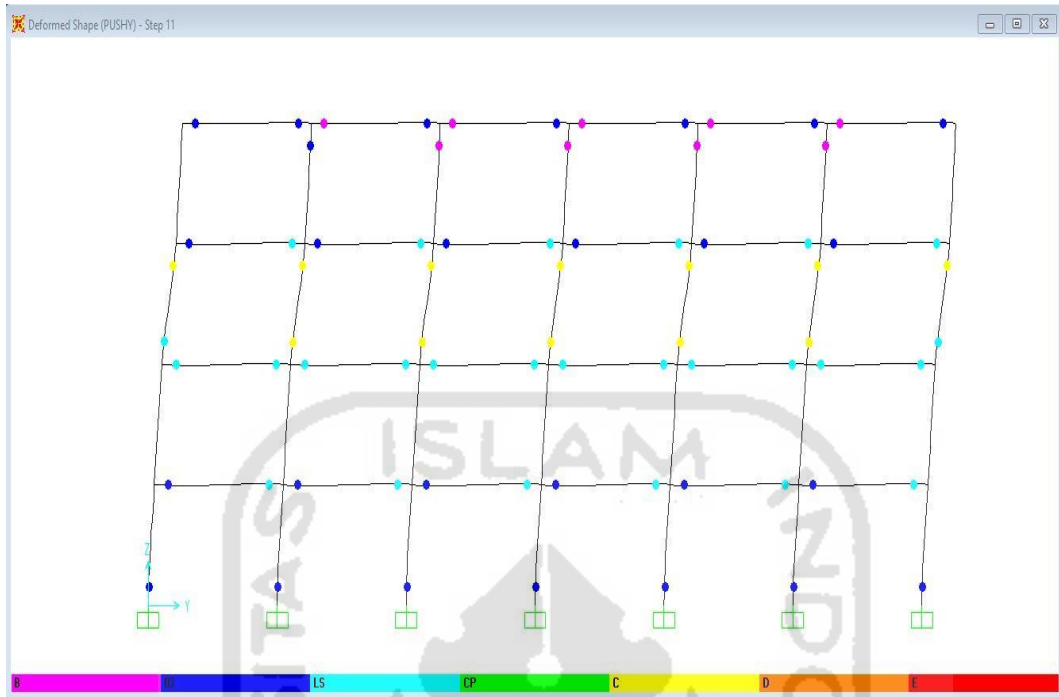

Lampiran 37. Sendi Plastis Arah Y Gedung 2 pada Step-13 dan Step-14

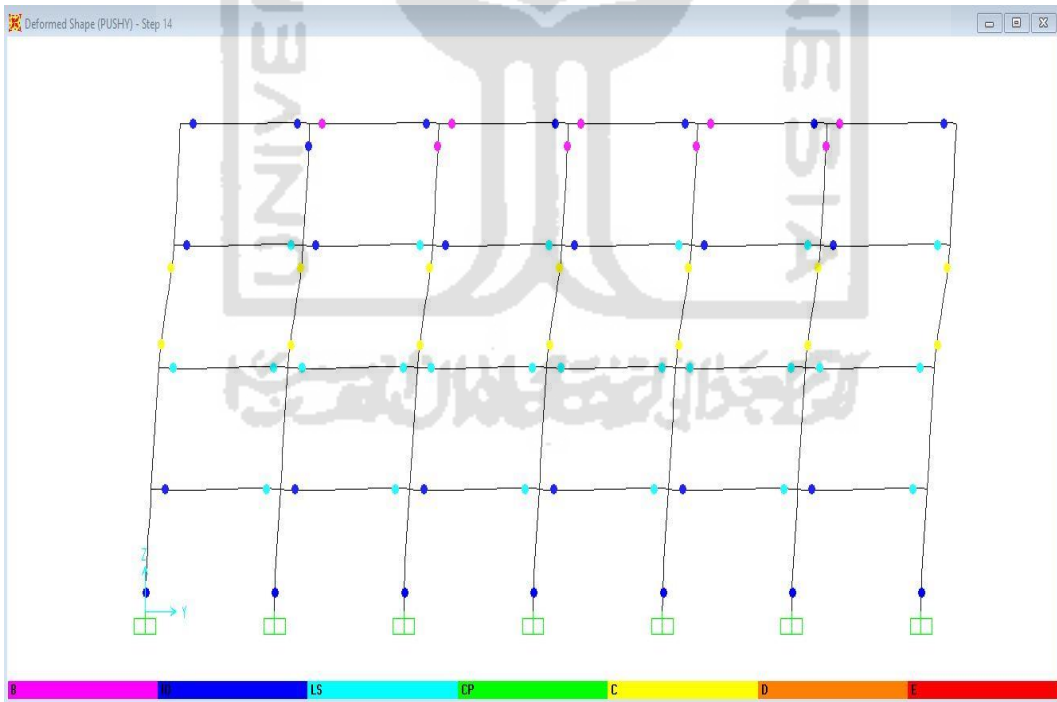
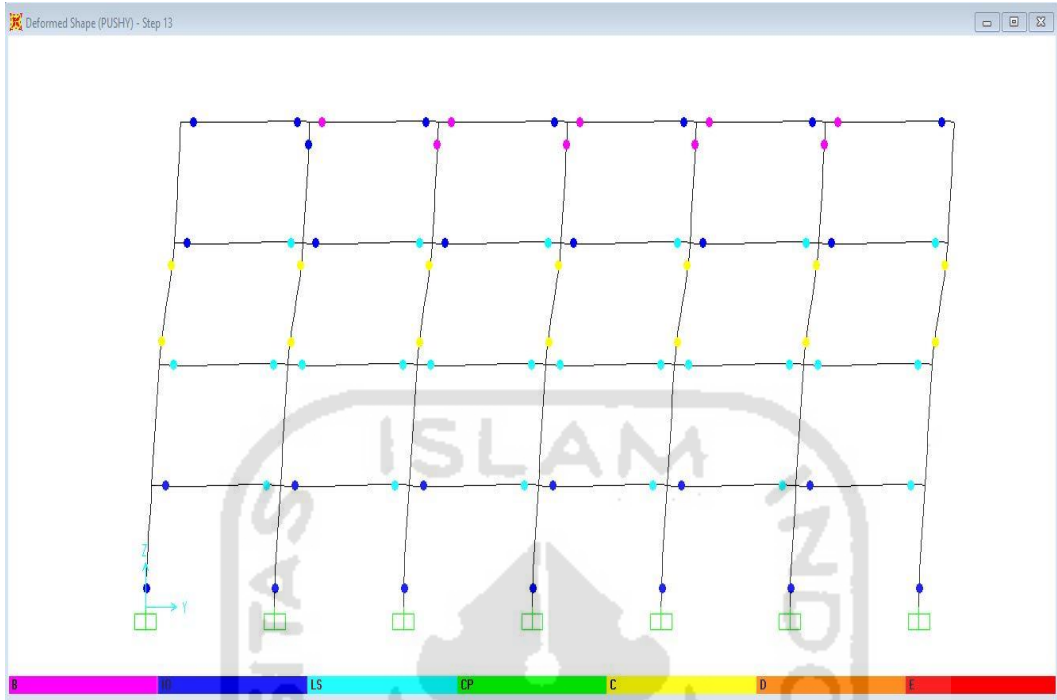



LAMPIRAN