

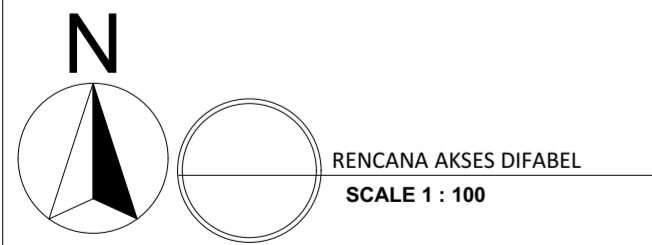

KETERANGAN	
Wc	Water Closet
Wd	Water Closet Difable
Ur	Urinoir
Ws	Wastafel
Stv	Stove
Sn	Sink



 Final Project Title	Project Name NITIPRAYAN ART AND CULTURAL CENTER	Student ID TIDI AYU LESTARI 12512164	Drawing Title	Drawing Scale	Sheet Number
	Project Location NITIPRAYAN, BANTUL, YOGYAKARTA	Supervisor IR. FAJRIYANTO	Drawing ID	Total Sheet	

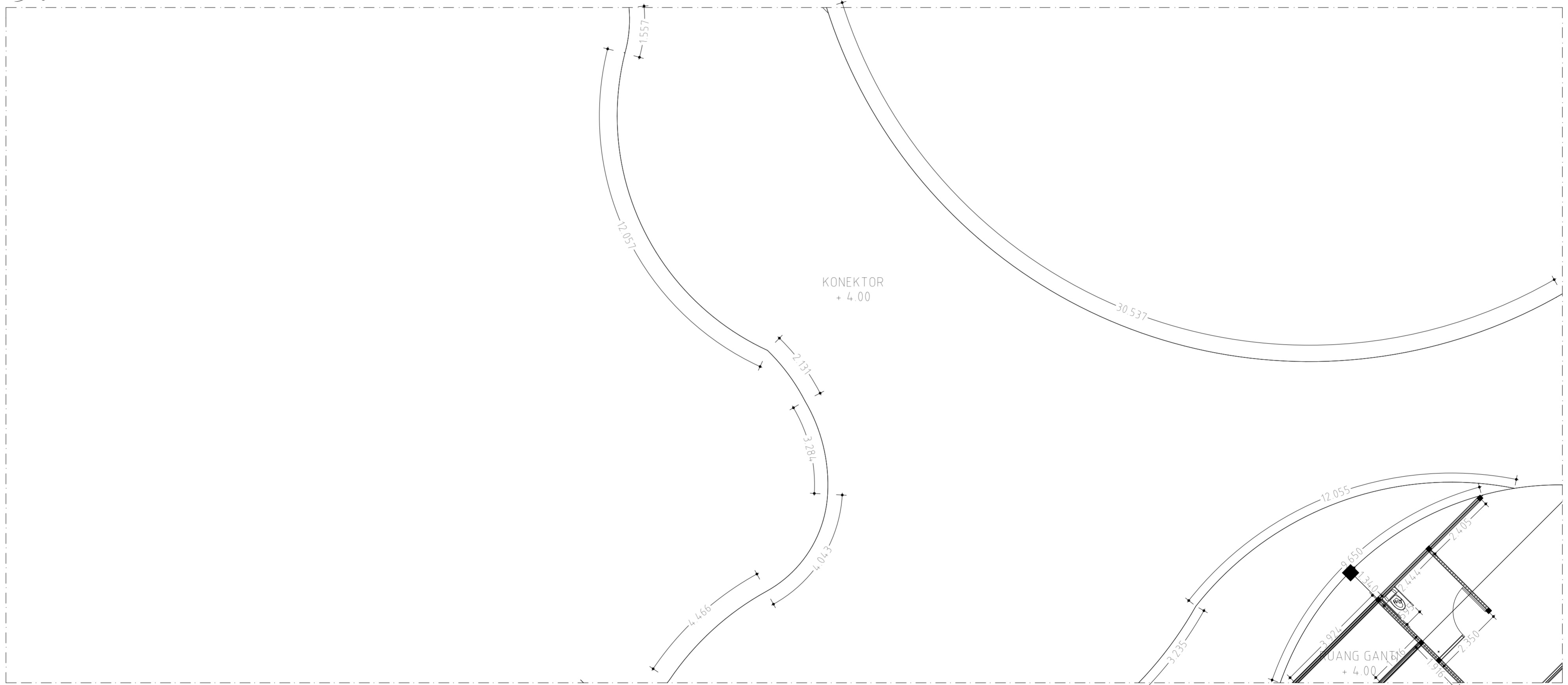
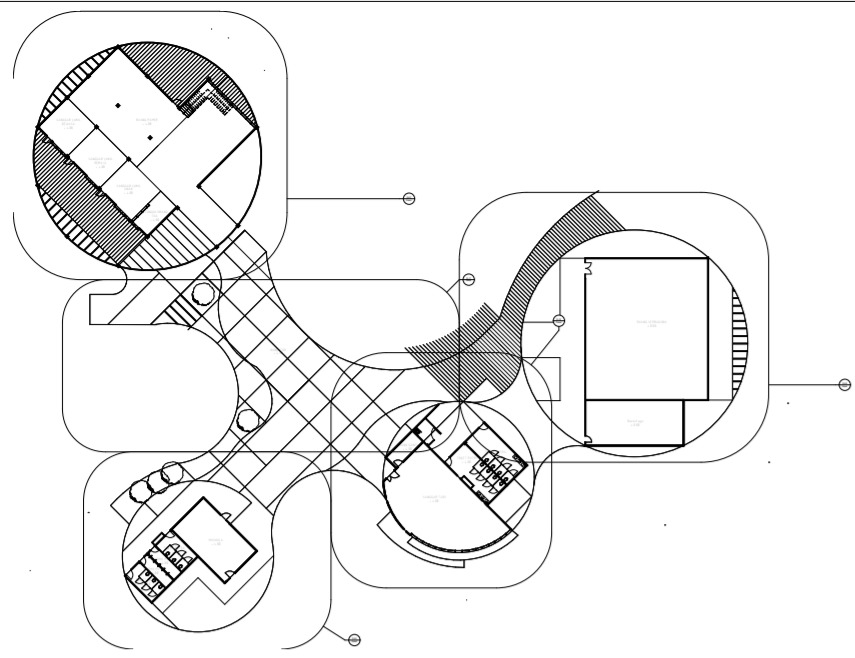

KETERANGAN	
Wc	Water Closet
Wd	Water Closet Difable
Ur	Urinoir
Ws	Wastafel
Stv	Stove
Sn	Sink

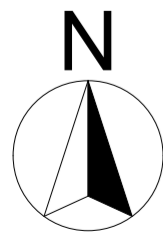

D.02.P11 DENAH PARSIAL LANTAI 2
SCALE 1 : 100

	Project Name	Student ID	Drawing Title	Drawing Scale	Sheet Number
	NITIPRAYAN ART AND CULTURAL CENTER	TIDI AYU LESTARI 12512164			
Final Project Title	Project Location	Supervisor	Drawing ID	Total Sheet	
	NITIPRAYAN, BANTUL, YOGYAKARTA	IR. FAJRIYANTO			

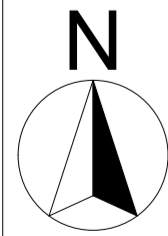
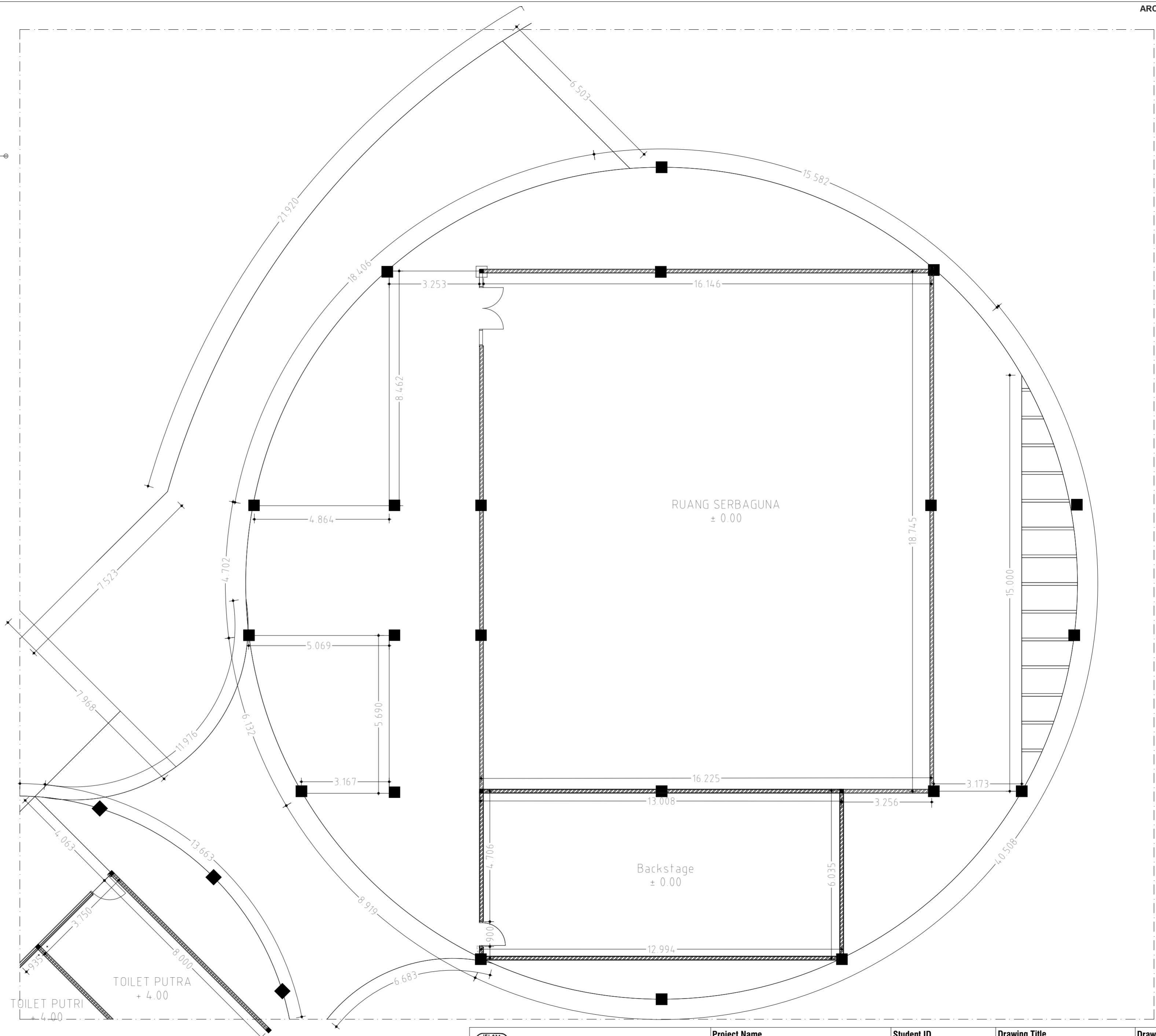
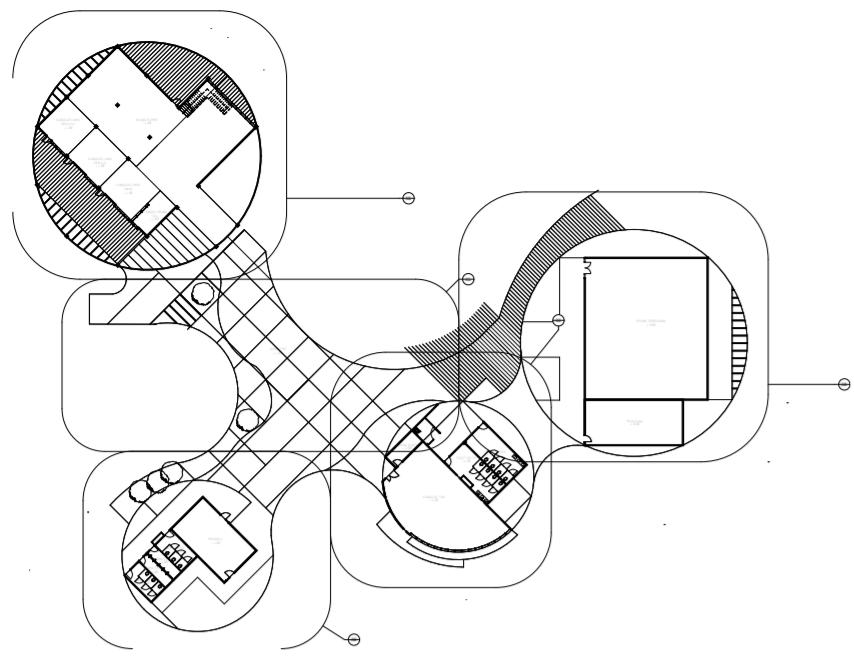

D.02.P8 DENAH PARSIAL LANTAI 2
SCALE 1 : 100

TOILET PUTRI
+ 4.00

TOILET PUTRA
+ 4.00

 Final Project Title	Project Name NITIPRAYAN ART AND CULTURAL CENTER	Student ID TIDI AYU LESTARI 12512164	Drawing Title	Drawing Scale	Sheet Number
	Project Location NITIPRAYAN, BANTUL, YOGYAKARTA	Supervisor IR. FAJRIYANTO			

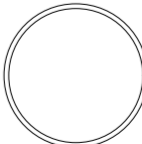
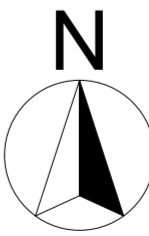
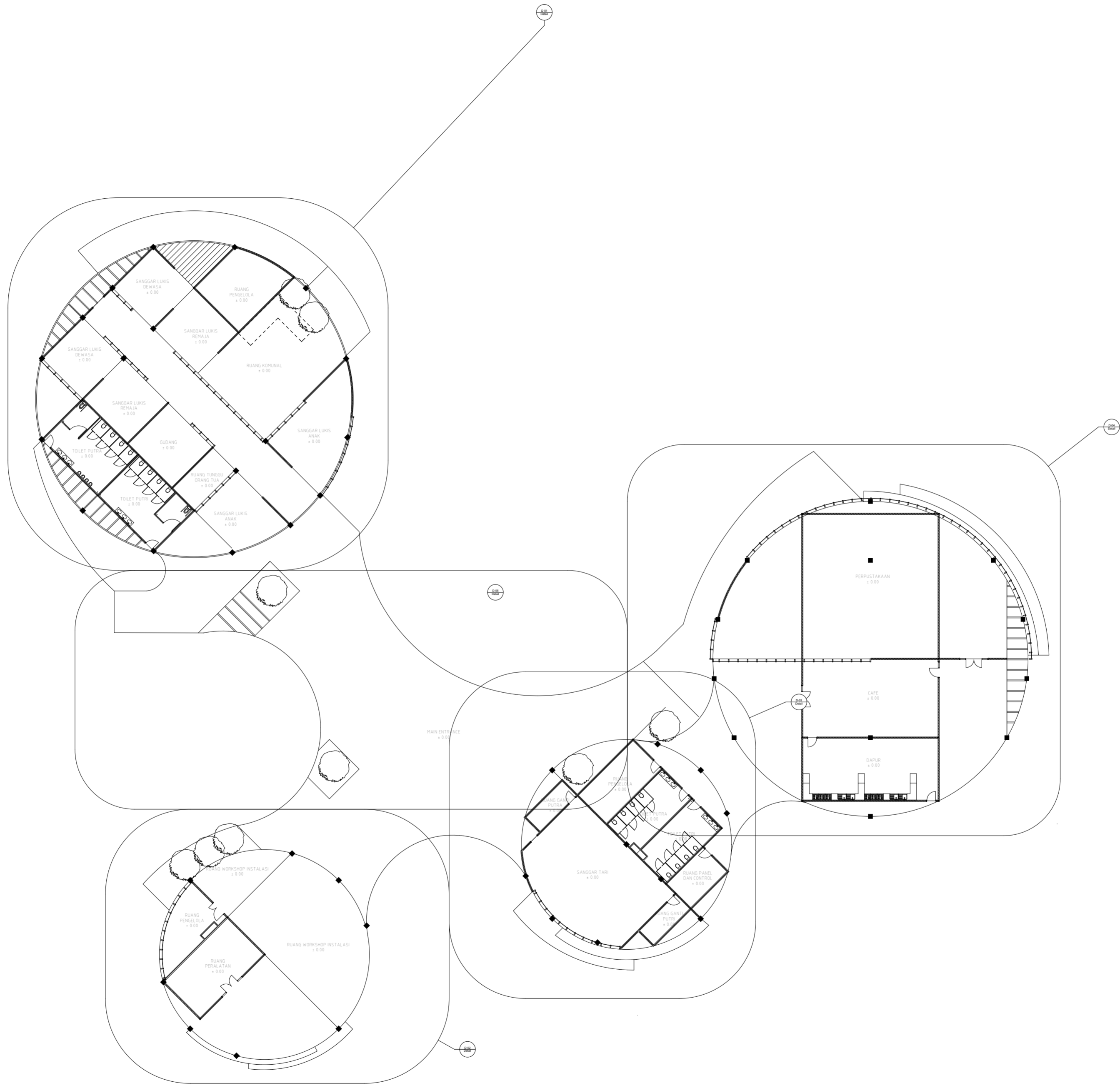

KEYPLAN DENAH LANTAI 1
SCALE 1:300

 Final Project Title	Project Name	Student ID	Drawing Title	Drawing Scale	Sheet Number
	NITIPRAYAN ART AND CULTURAL CENTER	TIDI AYU LESTARI 12512164		Drawing ID	Total Sheet
	Project Location	Supervisor			
	NITIPRAYAN, BANTUL, YOGYAKARTA	IR. FAJRIYANTO			

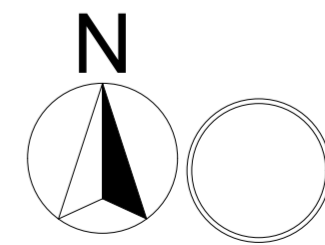
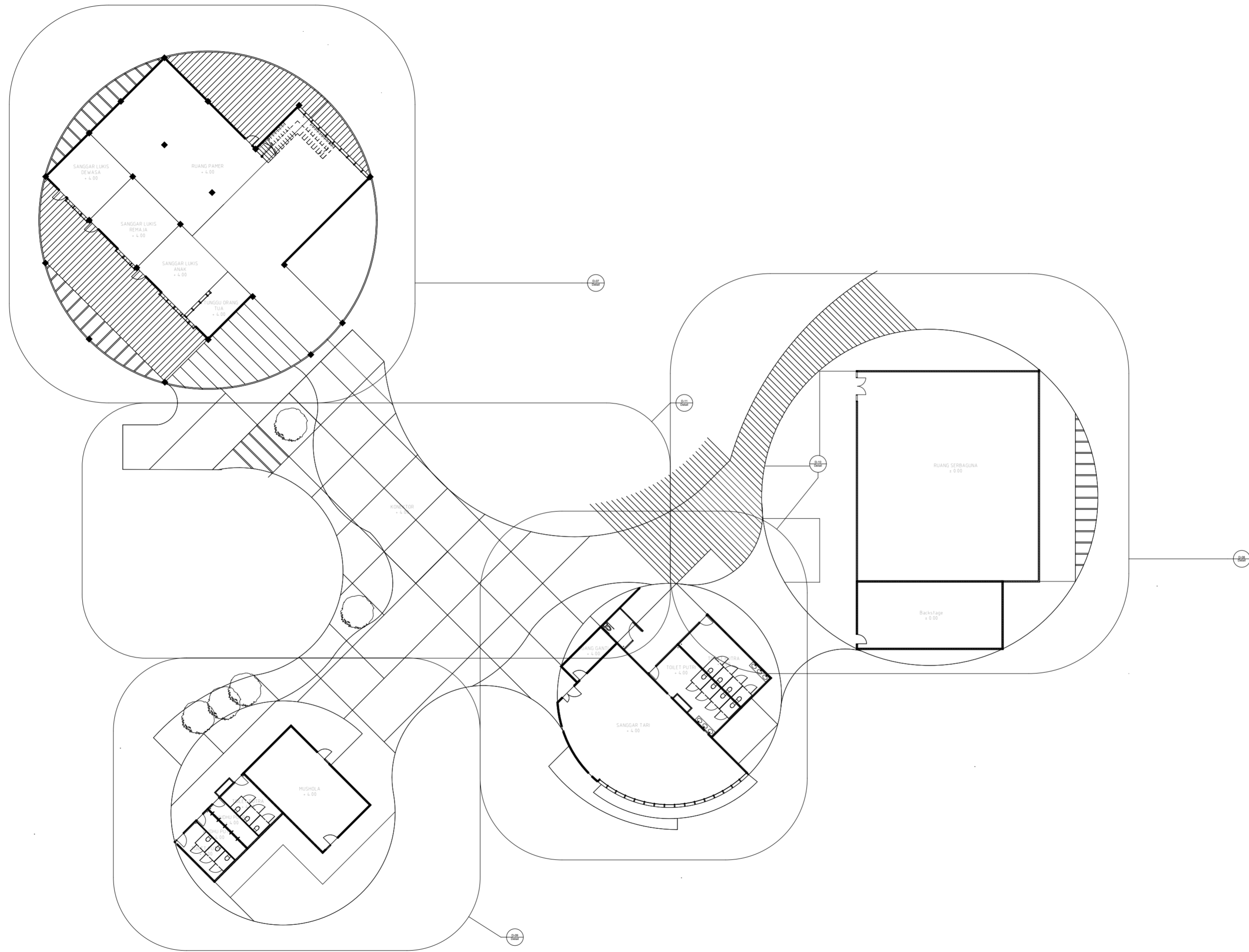

KEYPLAN DENAH LANTAI 2
 SCALE 1:300

 Final Project Title	Project Name	Student ID	Drawing Title	Drawing Scale	Sheet Number
	NITIPRAYAN ART AND CULTURAL CENTER	TIDI AYU LESTARI 12512164		Drawing ID	Total Sheet
	Project Location	Supervisor			
	NITIPRAYAN, BANTUL, YOGYAKARTA	IR. FAJRIYANTO			

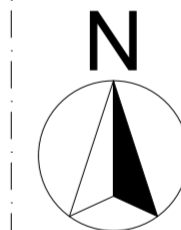
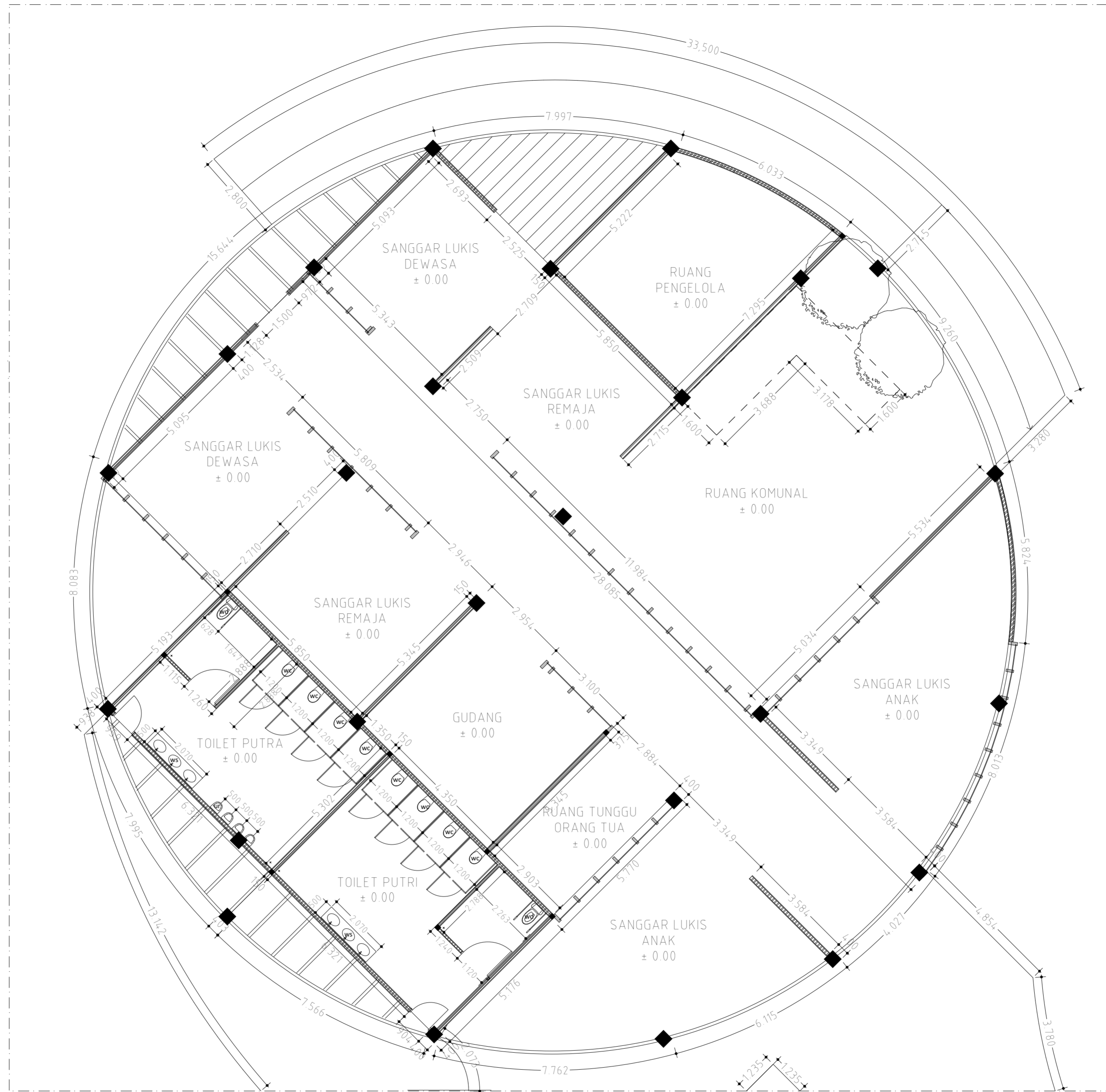
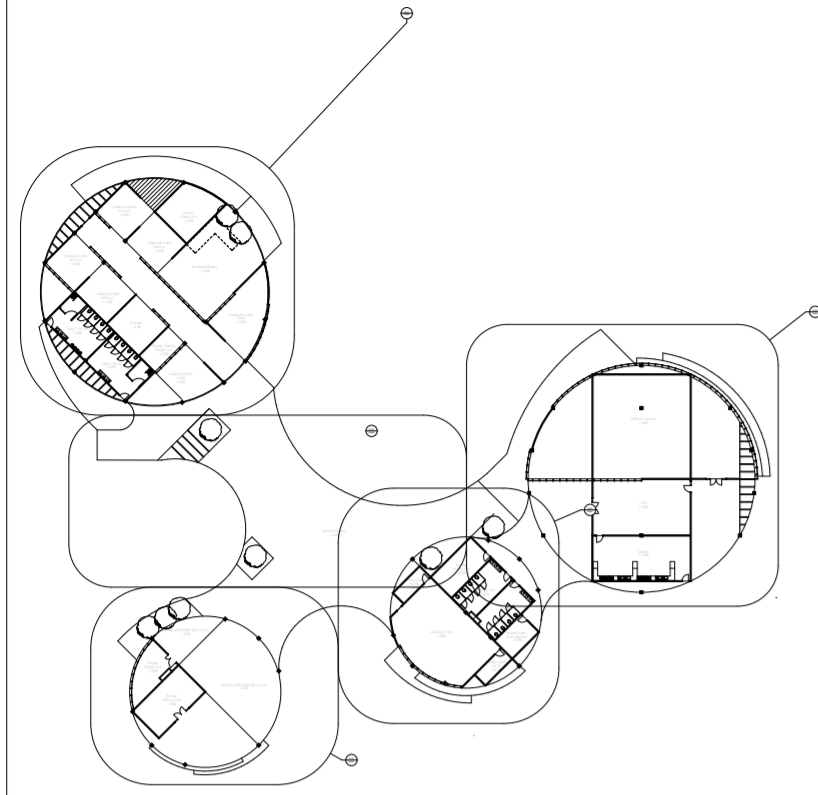

KETERANGAN	
Wc	Water Closet
Wd	Water Closet Difable
Ur	Urinoir
Ws	Wastafel
Stv	Stove
Sn	Sink

D.01.P
SCALE 1 : 100

 Final Project Title	Project Name NITIPRAYAN ART AND CULTURAL CENTER	Student ID TIDI AYU LESTARI 12512164	Drawing Title	Drawing Scale	Sheet Number
	Project Location NITIPRAYAN, BANTUL, YOGYAKARTA	Supervisor IR. FAJRIYANTO		Drawing ID	Total Sheet

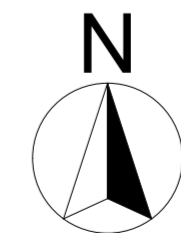
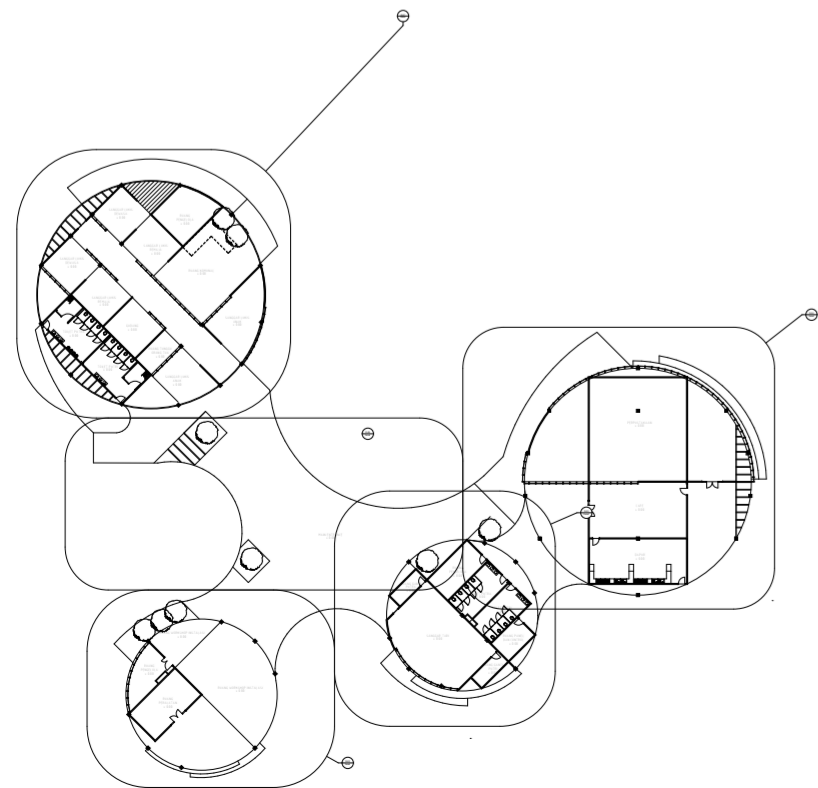
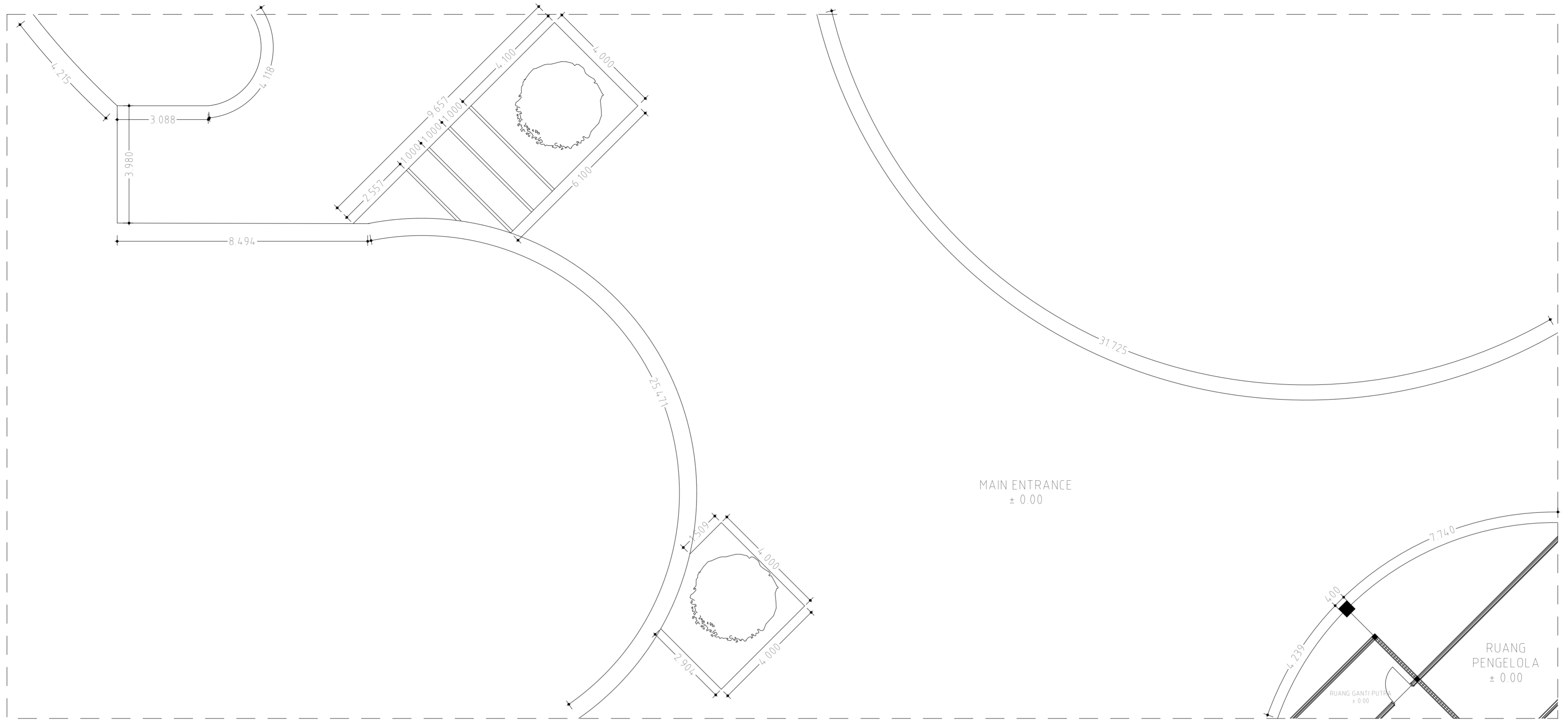

D.02.P

SCALE 1 : 100

	Project Name	Student ID	Drawing Title	Drawing Scale	Sheet Number
	NITIPRAYAN ART AND CULTURAL CENTER	TIDI AYU LESTARI 12512164			
Final Project Title	Project Location	Supervisor	Drawing ID	Total Sheet	
	NITIPRAYAN, BANTUL, YOGYAKARTA	IR. FAJRIYANTO			

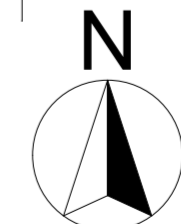
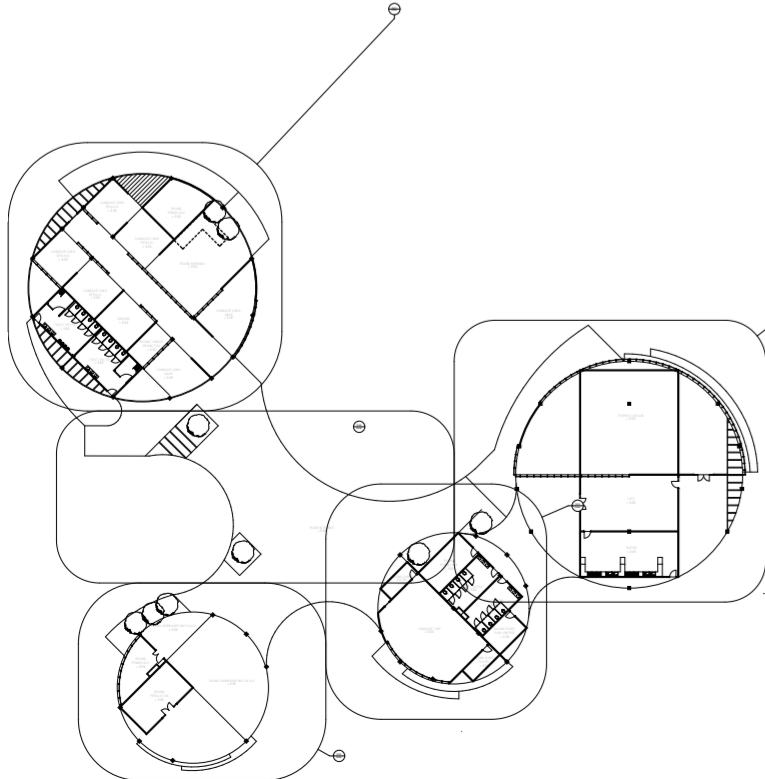
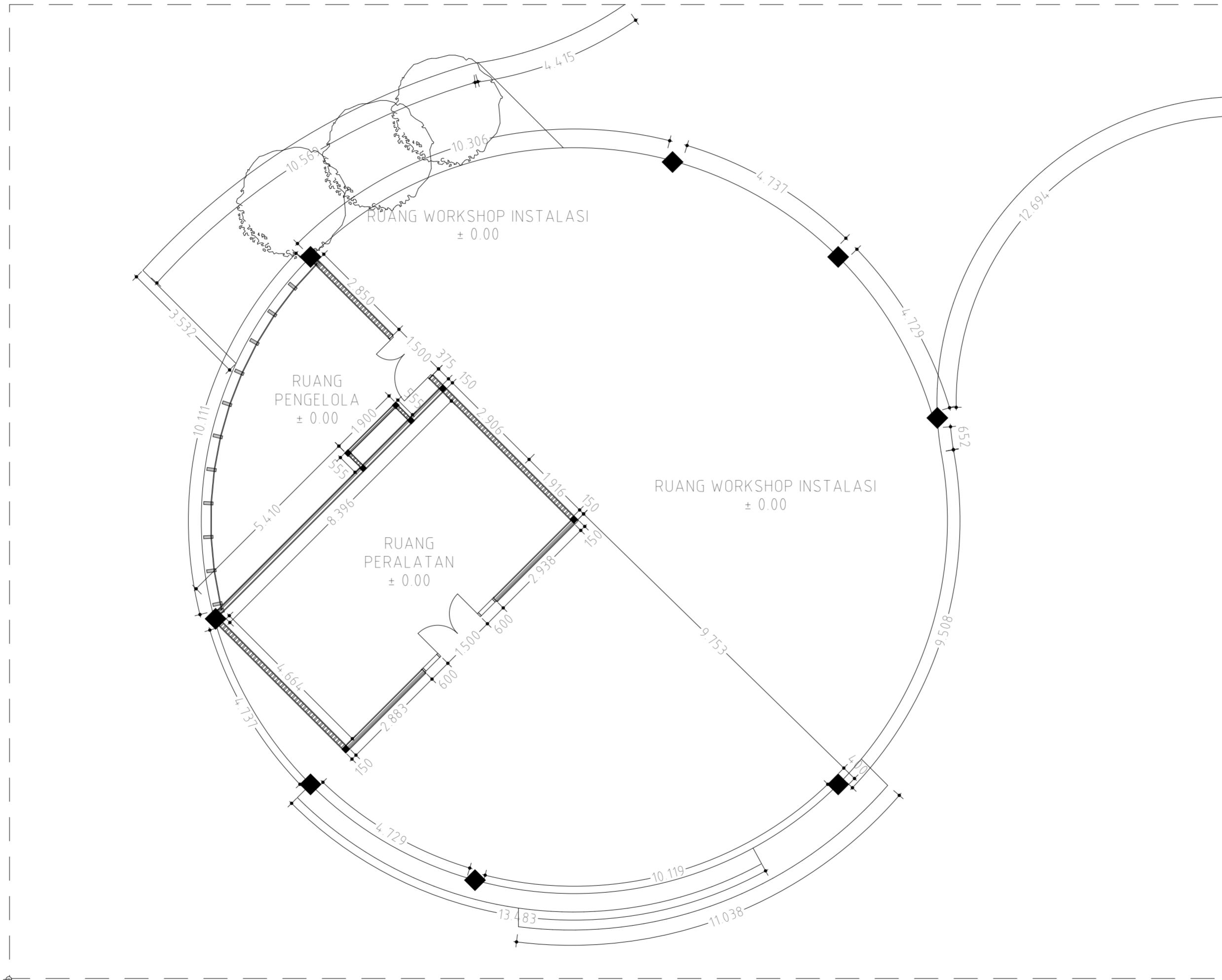

D.03.P

SCALE 1 : 100

	Project Name	Student ID	Drawing Title	Drawing Scale	Sheet Number
	NITIPRAYAN ART AND CULTURAL CENTER	TIDI AYU LESTARI 12512164			
Final Project Title	Project Location	Supervisor	Drawing ID	Total Sheet	
	NITIPRAYAN, BANTUL, YOGYAKARTA	IR. FAJRIYANTO			

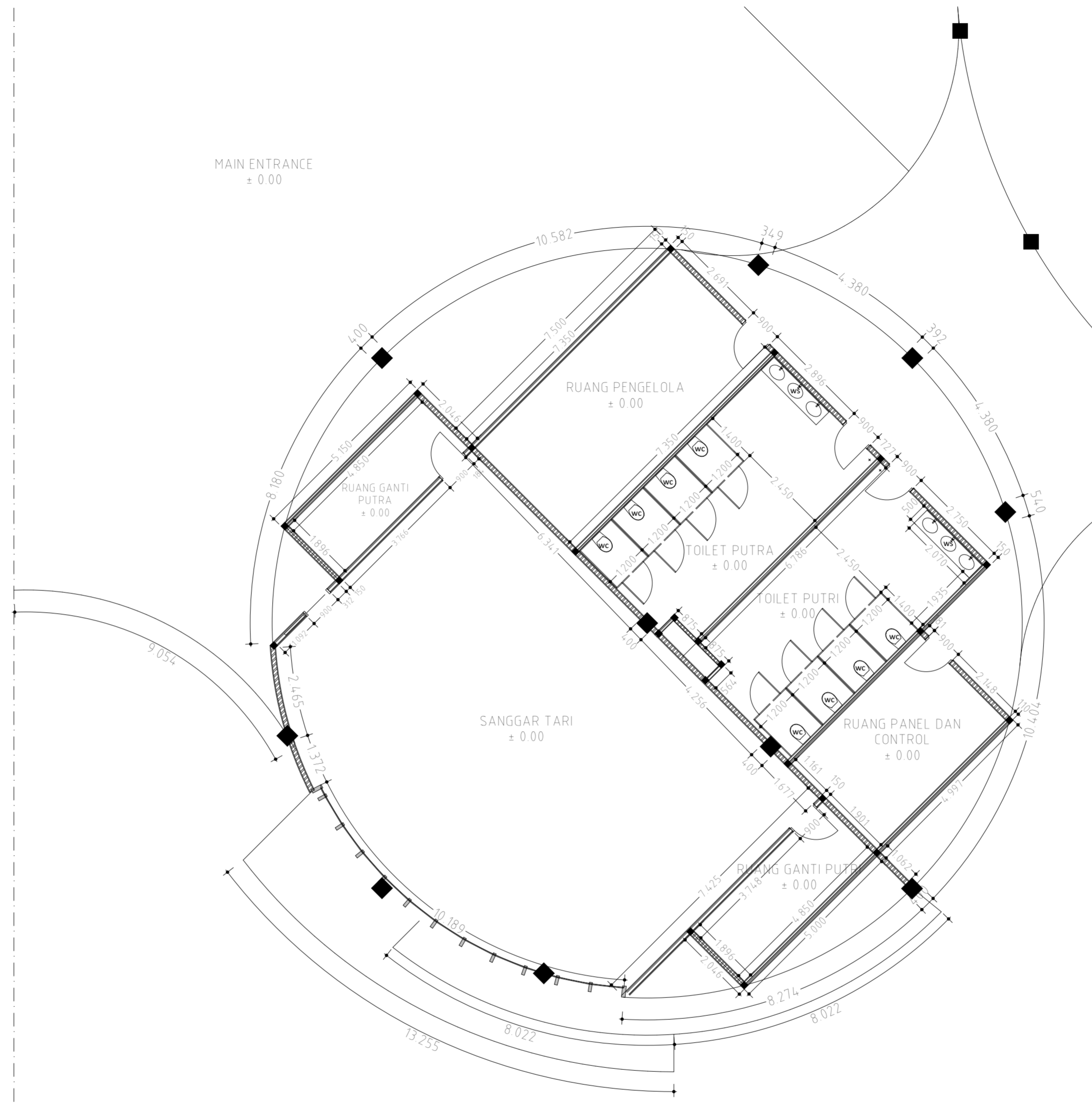

KETERANGAN	
Wc	Water Closet
Wd	Water Closet Difable
Ur	Urinoir
Ws	Wastafel
Stv	Stove
Sn	Sink

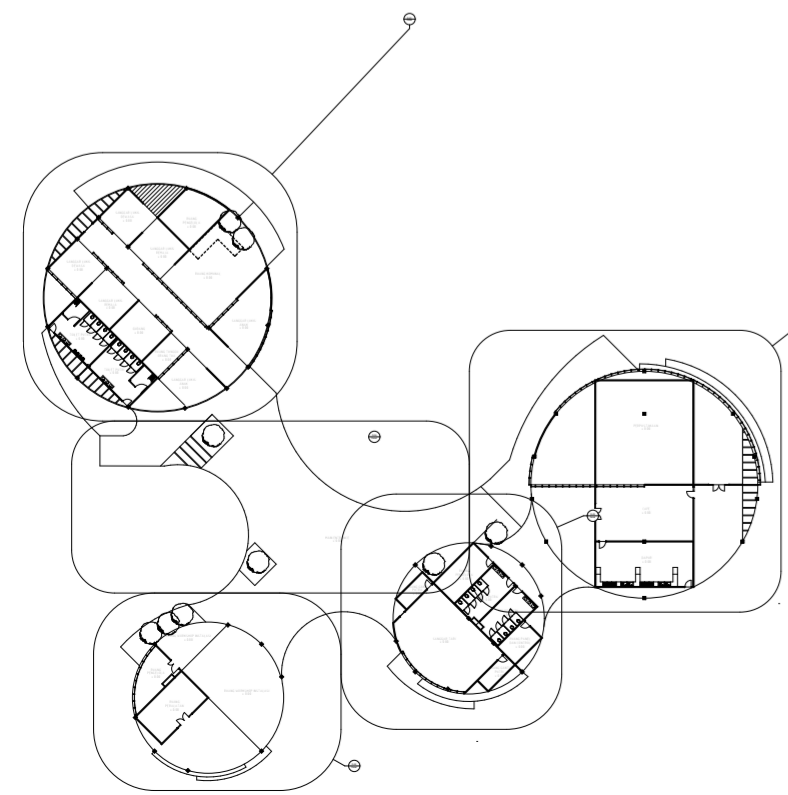

D.04.P

SCALE 1 : 100

	Project Name	Student ID	Drawing Title	Drawing Scale	Sheet Number
	NITIPRAYAN ART AND CULTURAL CENTER	TIDI AYU LESTARI 12512164			
Final Project Title	Project Location	Supervisor	Drawing ID	Total Sheet	
	NITIPRAYAN, BANTUL, YOGYAKARTA	IR. FAJRIYANTO			

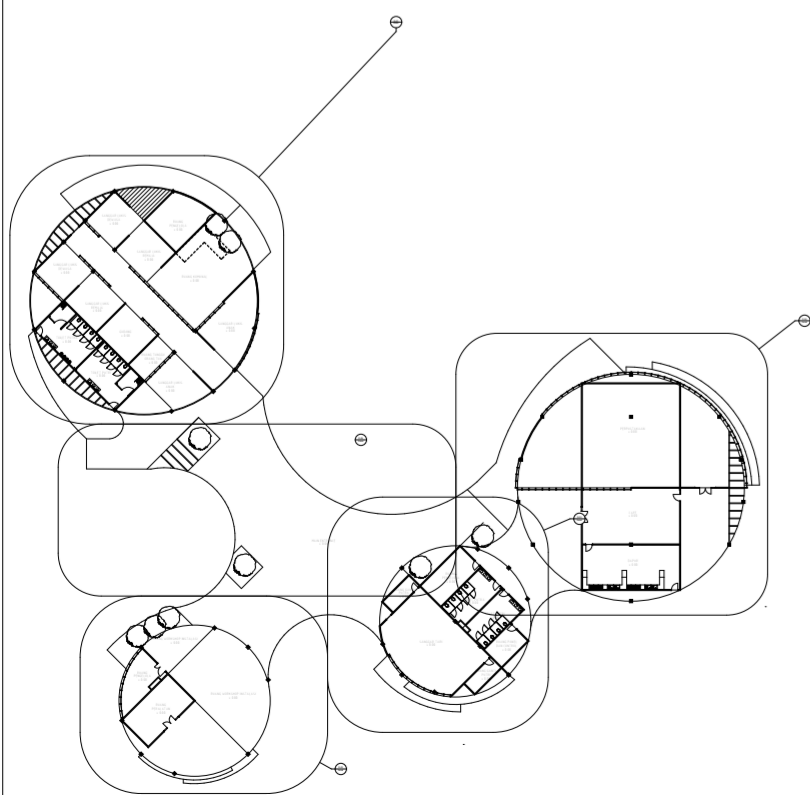
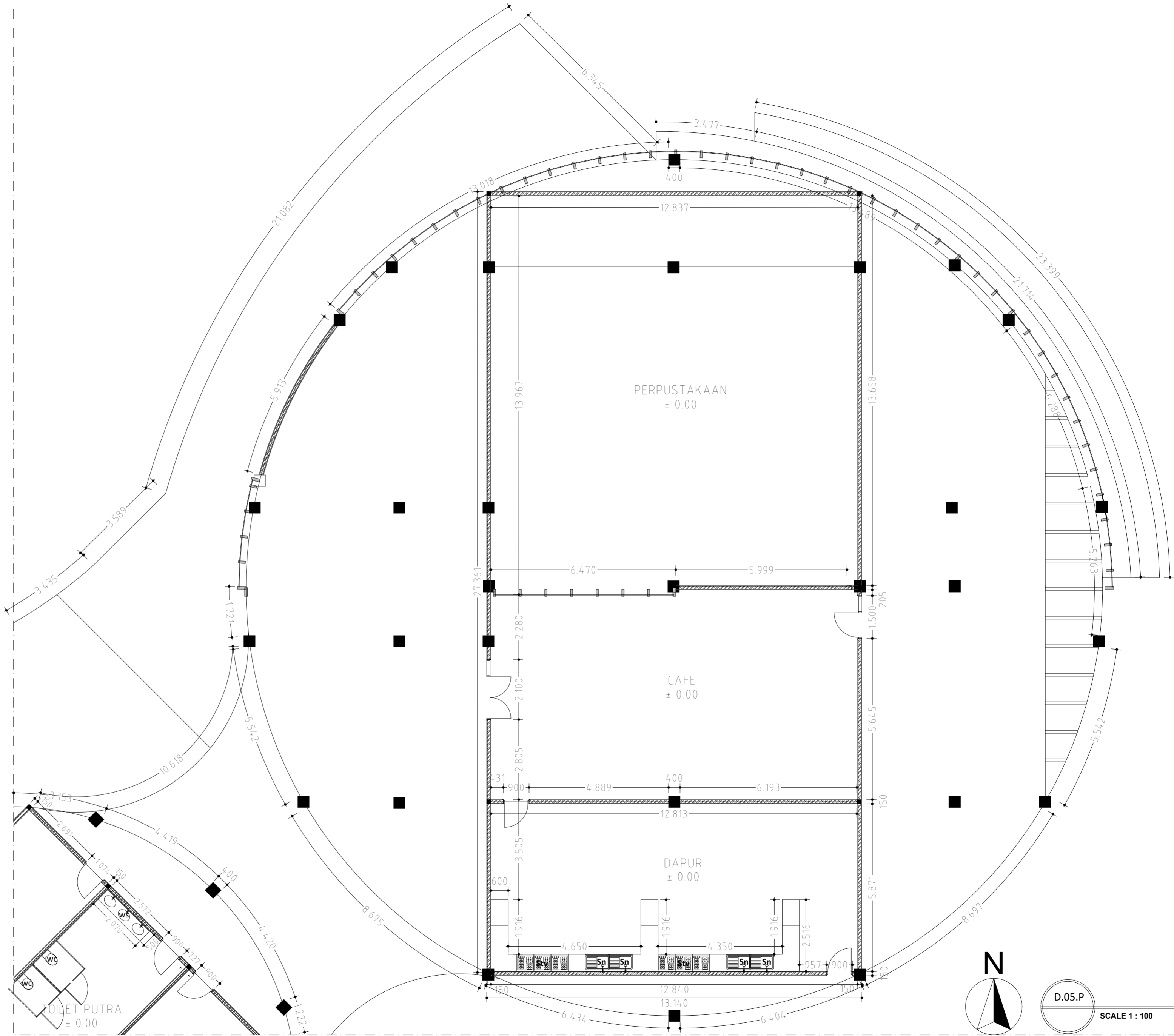

KETERANGAN	
Wc	Water Closet
Wd	Water Closet Difable
Ur	Urinoir
Ws	Wastafel
Stv	Stove
Sn	Sink

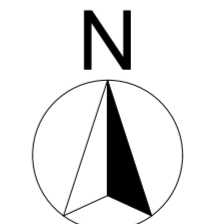

D.05.P

SCALE 1 : 100

 Final Project Title	Project Name NITIPRAYAN ART AND CULTURAL CENTER	Student ID TIDI AYU LESTARI 12512164	Drawing Title	Drawing Scale	Sheet Number
	Project Location NITIPRAYAN, BANTUL, YOGYAKARTA	Supervisor IR. FAJRIYANTO	Drawing ID	Total Sheet	

+12.50
+9.25
+7.50
Lantai 2
+4.00
Lantai 1
-0.90
Ampiteater

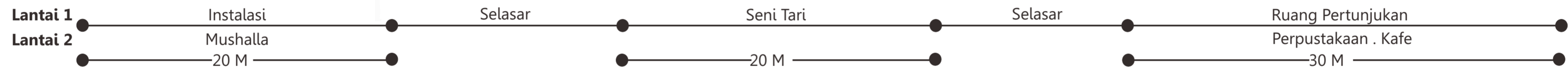
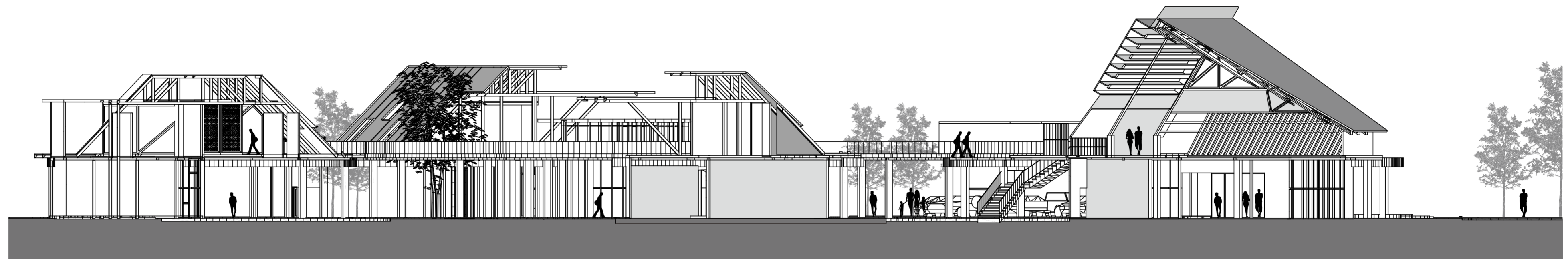

POTONGAN KAWASAN A-A'
SKALA 1 : 200

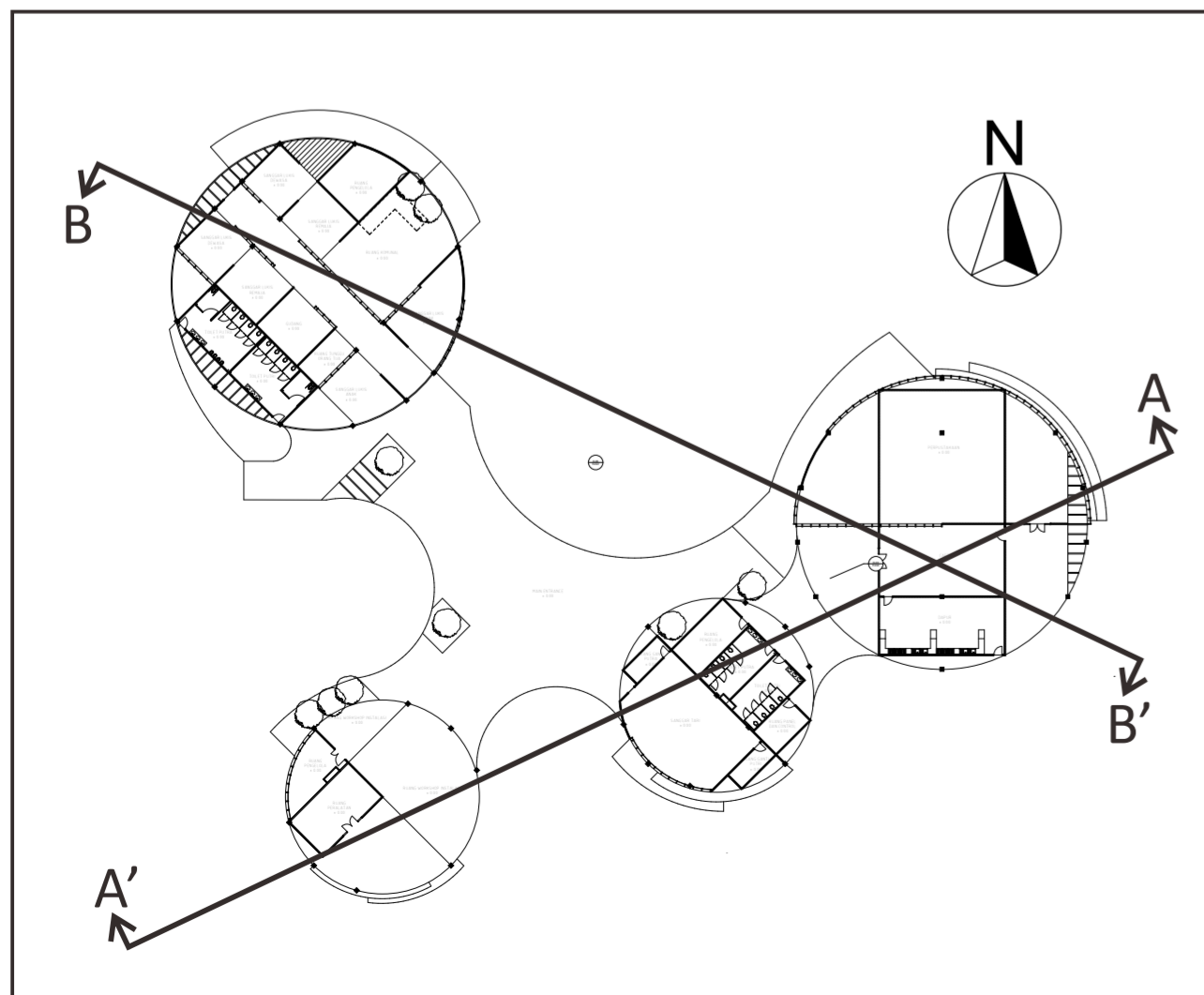

	Project Name	Student ID	Drawing Title	Drawing Scale	Sheet Number
	NITIPRAYAN ART AND CULTURAL CENTER	TIDI AYU LESTARI 12512164			
Final Project Title	Project Location	Supervisor		Drawing ID	Total Sheet
	NITIPRAYAN, BANTUL, YOGYAKARTA	IR. FAJRIYANTO			

+12.50
+9.25
+7.50
Lantai 2
+4.00
Lantai 1
-0.90
Ampiteater

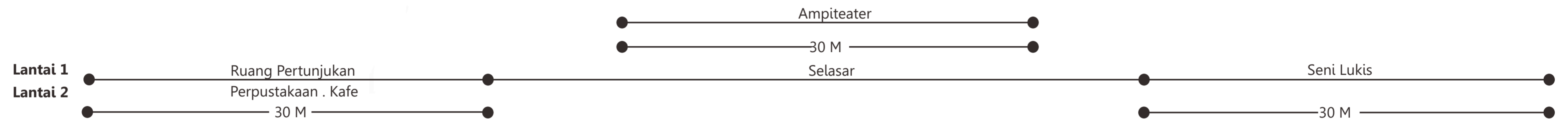

POTONGAN KAWASAN B-B'
SKALA 1 : 200

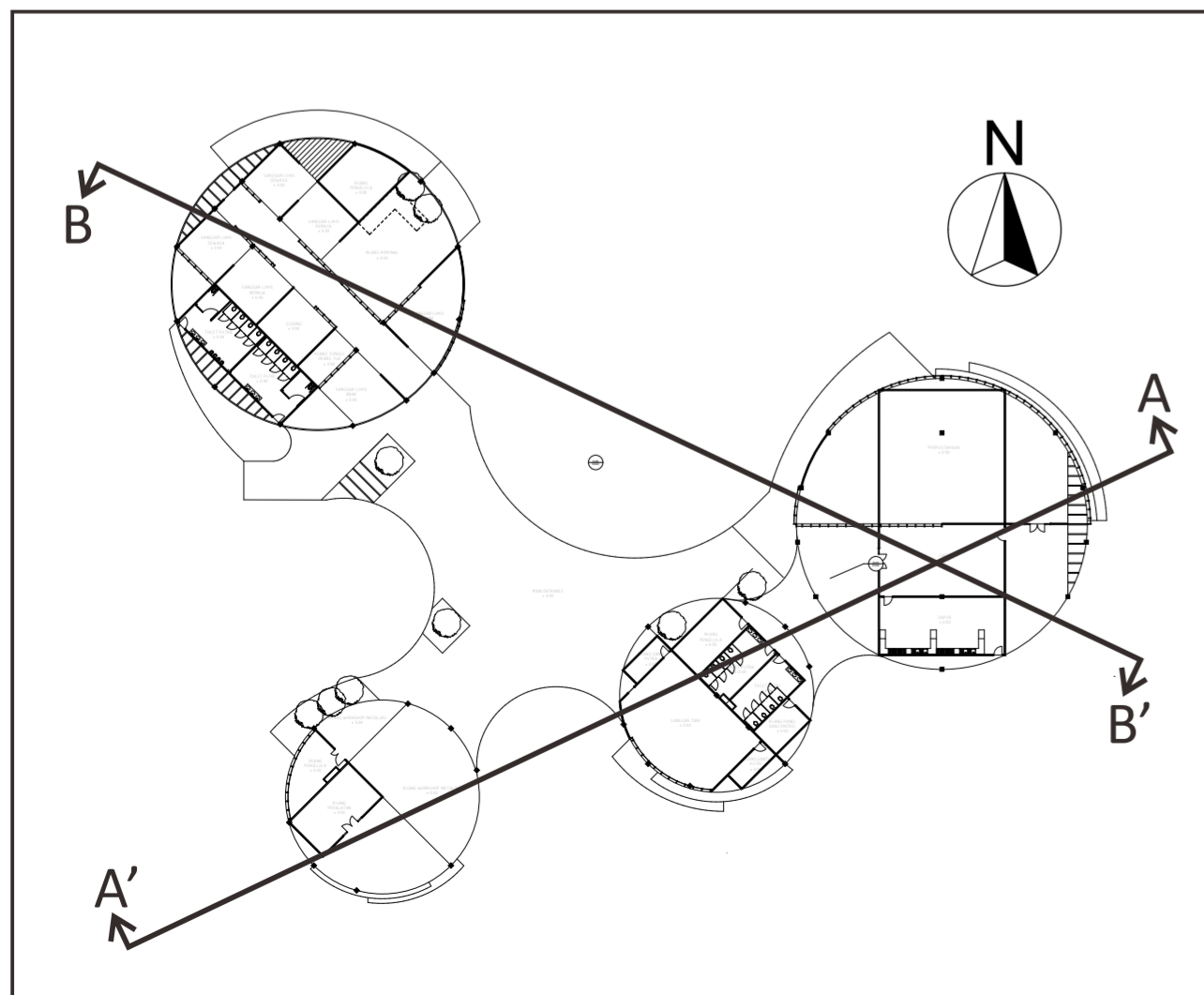

	Project Name	Student ID	Drawing Title	Drawing Scale	Sheet Number
	NITIPRAYAN ART AND CULTURAL CENTER	TIDI AYU LESTARI 12512164			
Final Project Title	Project Location	Supervisor		Drawing ID	Total Sheet
	NITIPRAYAN, BANTUL, YOGYAKARTA	IR. FAJRIYANTO			

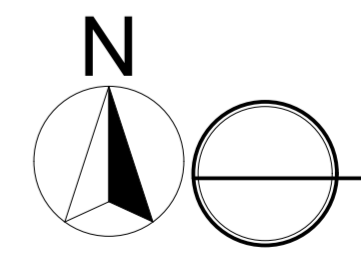
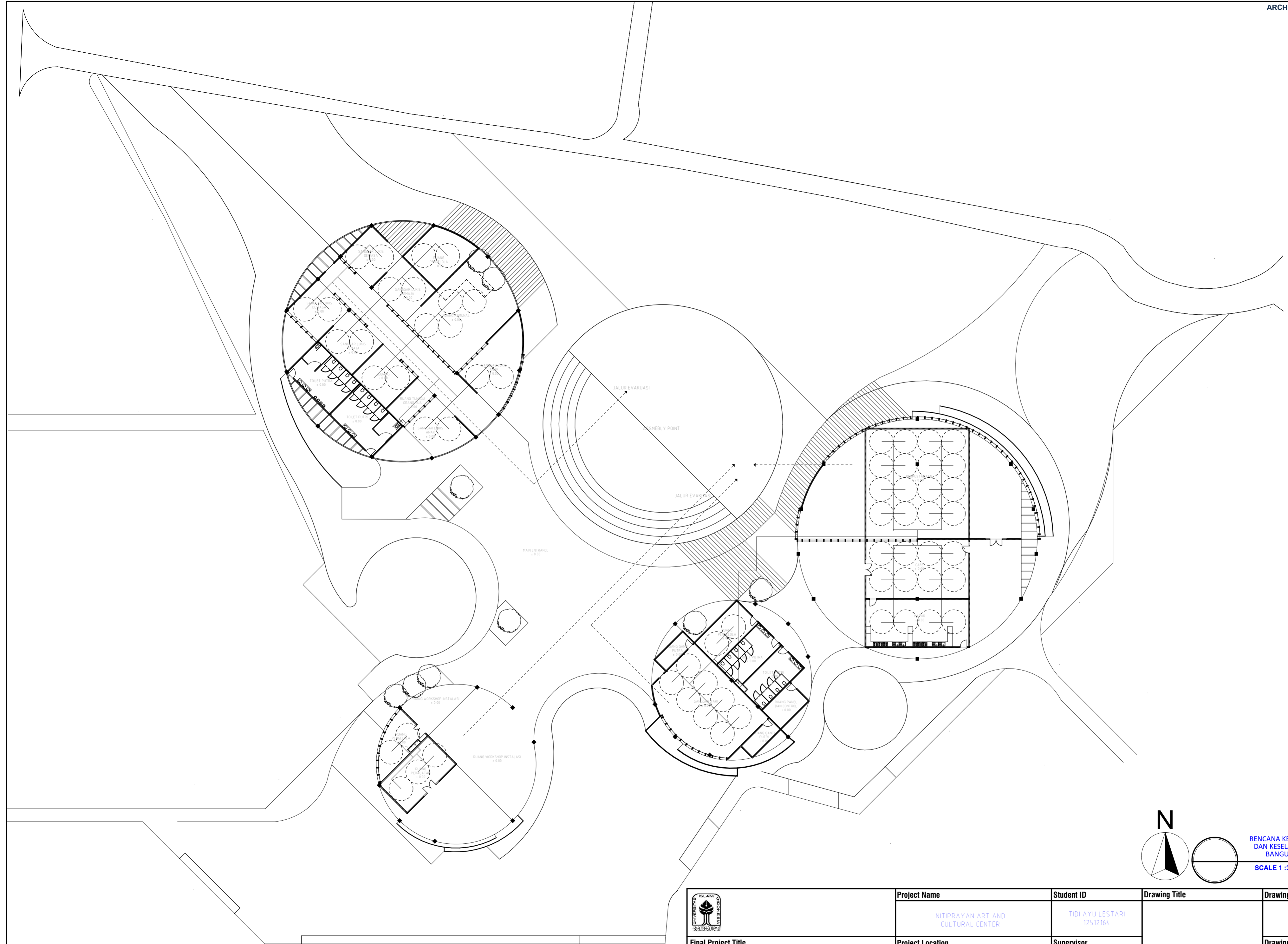

RENCANA KEAMANAN
DAN KESELAMATAN
BANGUNAN

SCALE 1 : 300

 Final Project Title	Project Name NITIPRAYAN ART AND CULTURAL CENTER	Student ID TIDI AYU LESTARI 12512164	Drawing Title	Drawing Scale	Sheet Number
	Project Location NITIPRAYAN, BANTUL, YOGYAKARTA	Supervisor IR. FAJRIYANTO	Drawing ID	Total Sheet	

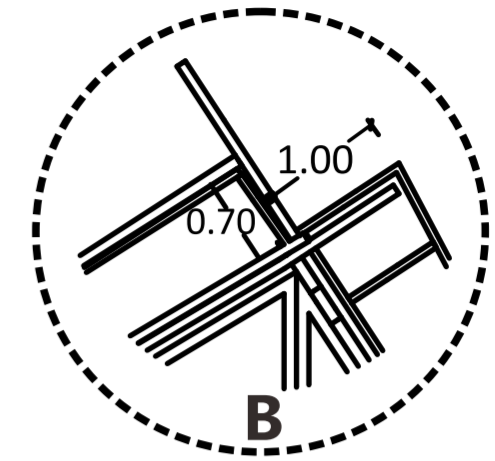
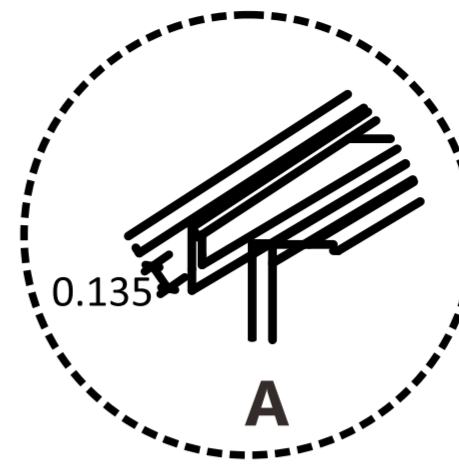
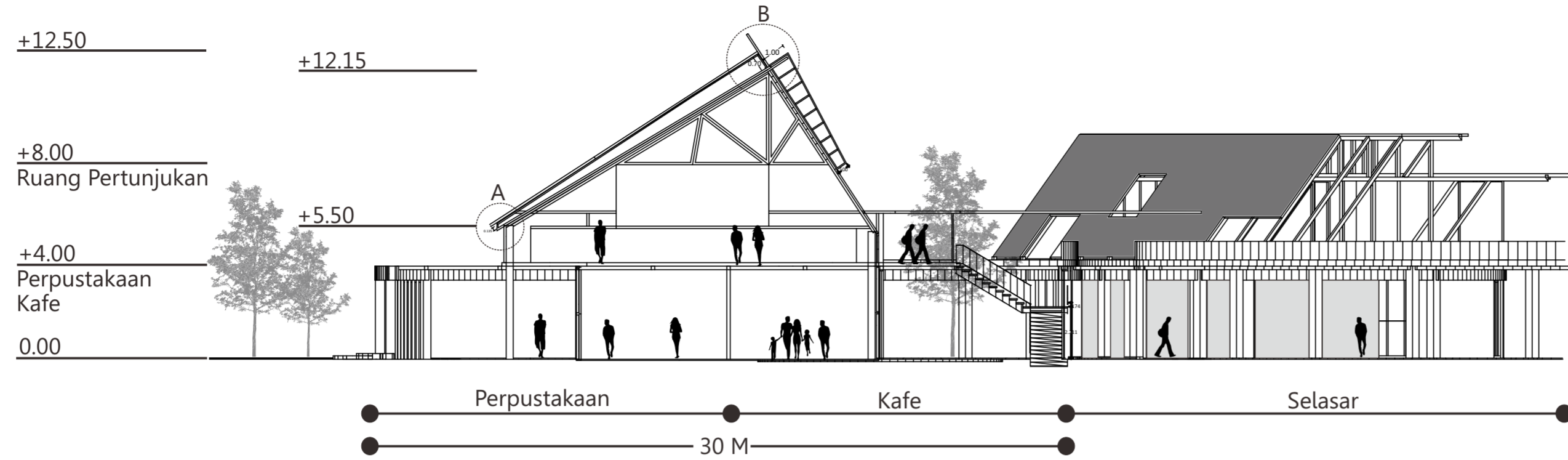

A POTONGAN BANGUNAN PERTUNJUKAN - PERPUSTAKAAN - KAFE
SKALA 1 : 200

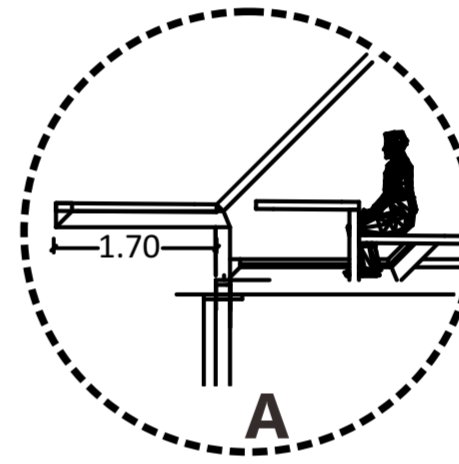
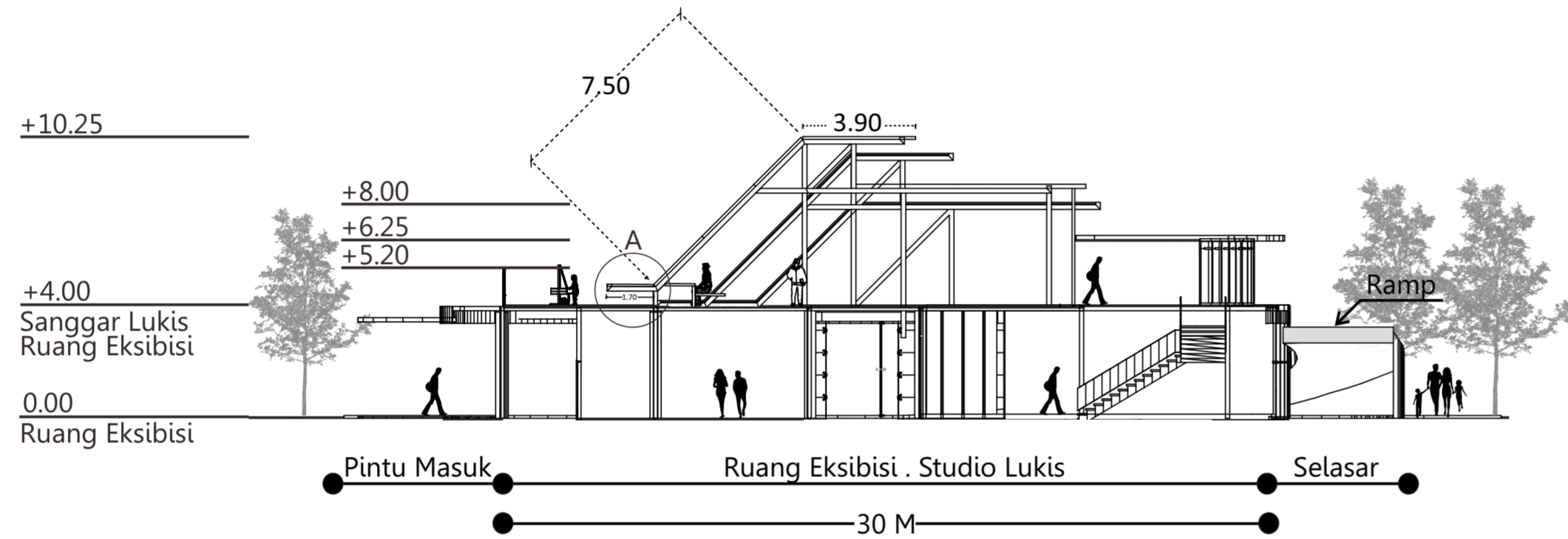

B POTONGAN BANGUNAN KOMUNITAS SENI LUKIS
SKALA 1 : 200

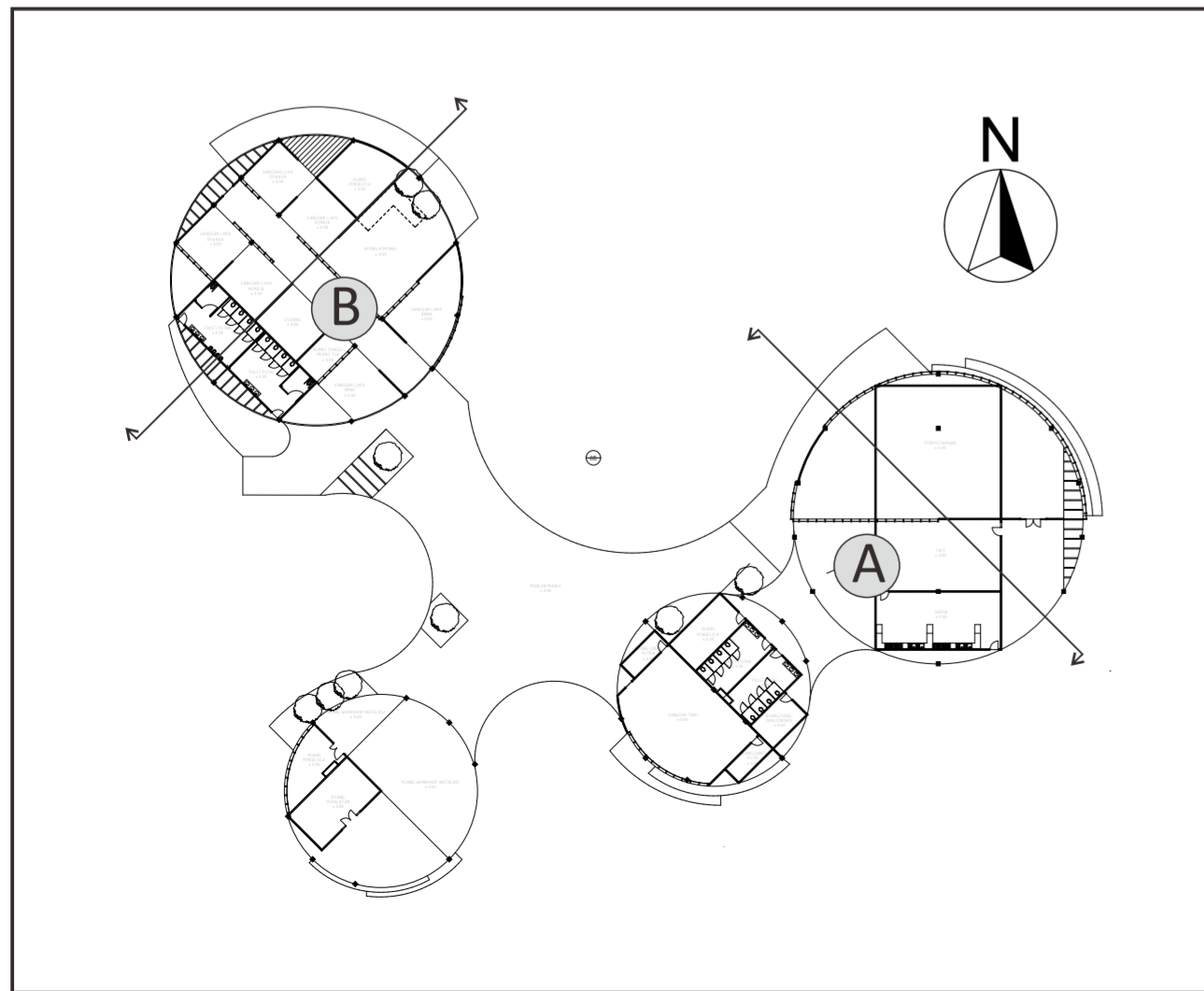

	Project Name	Student ID	Drawing Title	Drawing Scale	Sheet Number
	NITIPRAYAN ART AND CULTURAL CENTER	TIDI AYU LESTARI 12512164			
Final Project Title	Project Location	Supervisor		Drawing ID	Total Sheet
	NITIPRAYAN, BANTUL, YOGYAKARTA	IR. FAJRIYANTO			

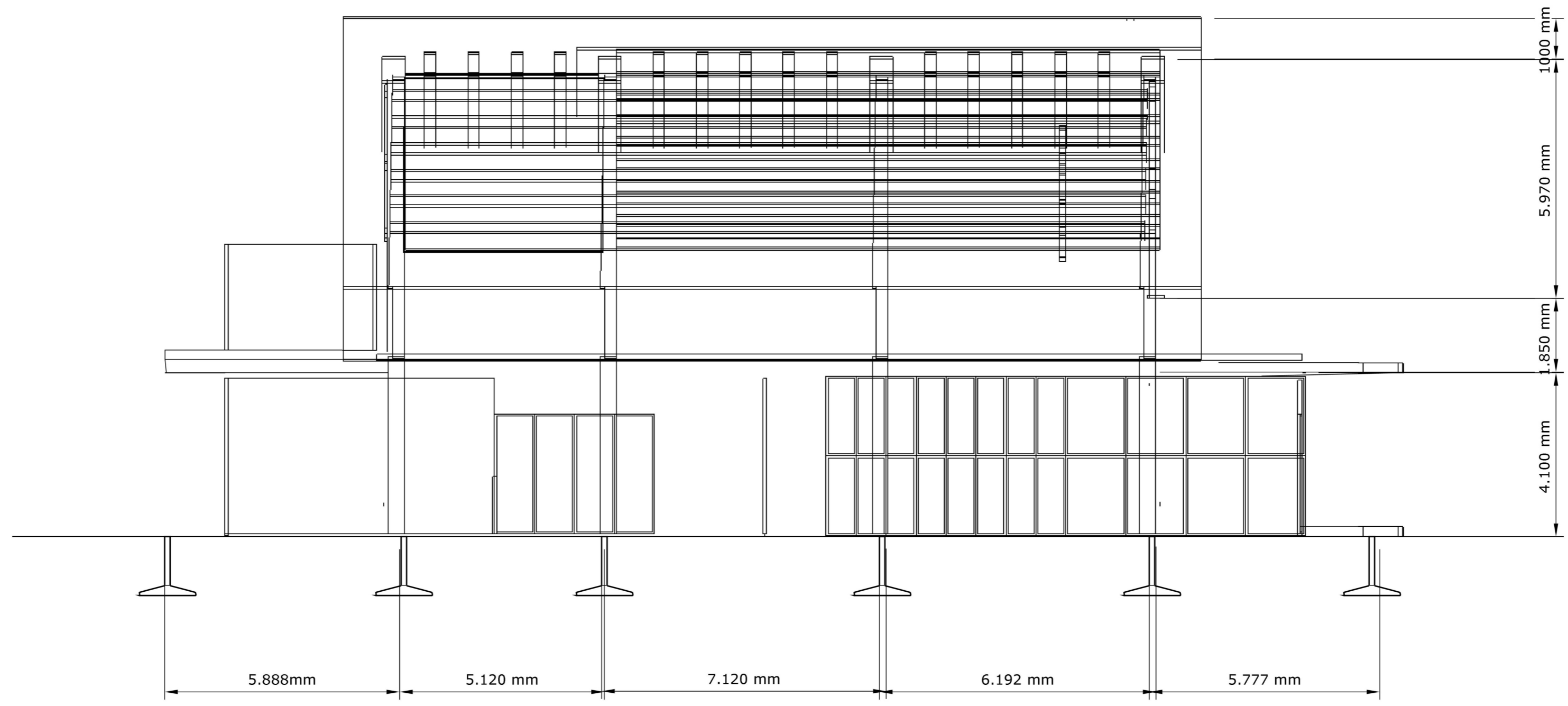

Fakultas Teknik Sipil dan Perencanaan
Universitas Islam Indonesia

Nitiprayan Art and Cultural Center
POTONGAN A'A
SKALA 1:100

TIDI AYU LESTARI
12512164
Pembimbing : Ir. Fajriyanto

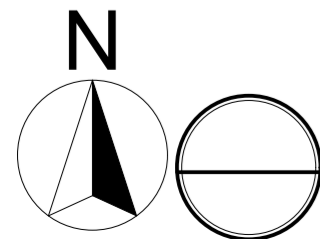
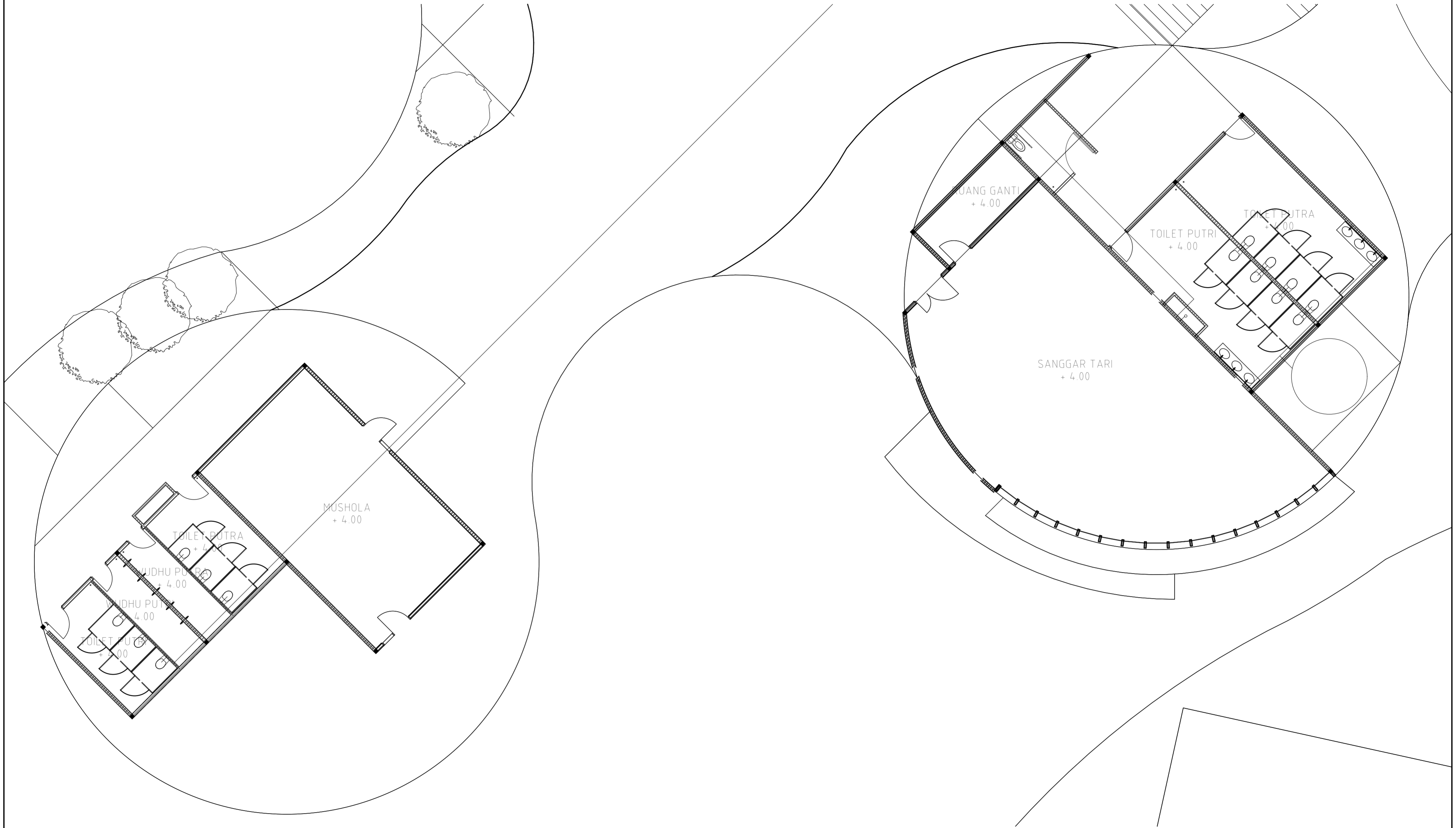

RENCANA AIR BERSIH LANTAI 2
SCALE 1 : 100

	Project Name	Student ID	Drawing Title	Drawing Scale	Sheet Number
	NITIPRAYAN ART AND CULTURAL CENTER	TIDI AYU LESTARI 12512164			
Final Project Title	Project Location	Supervisor	Drawing ID	Total Sheet	
	NITIPRAYAN, BANTUL, YOGYAKARTA	IR. FAJRIYANTO			

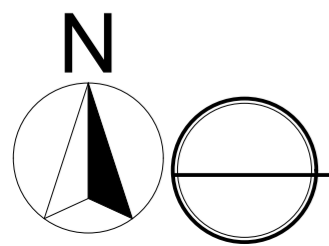
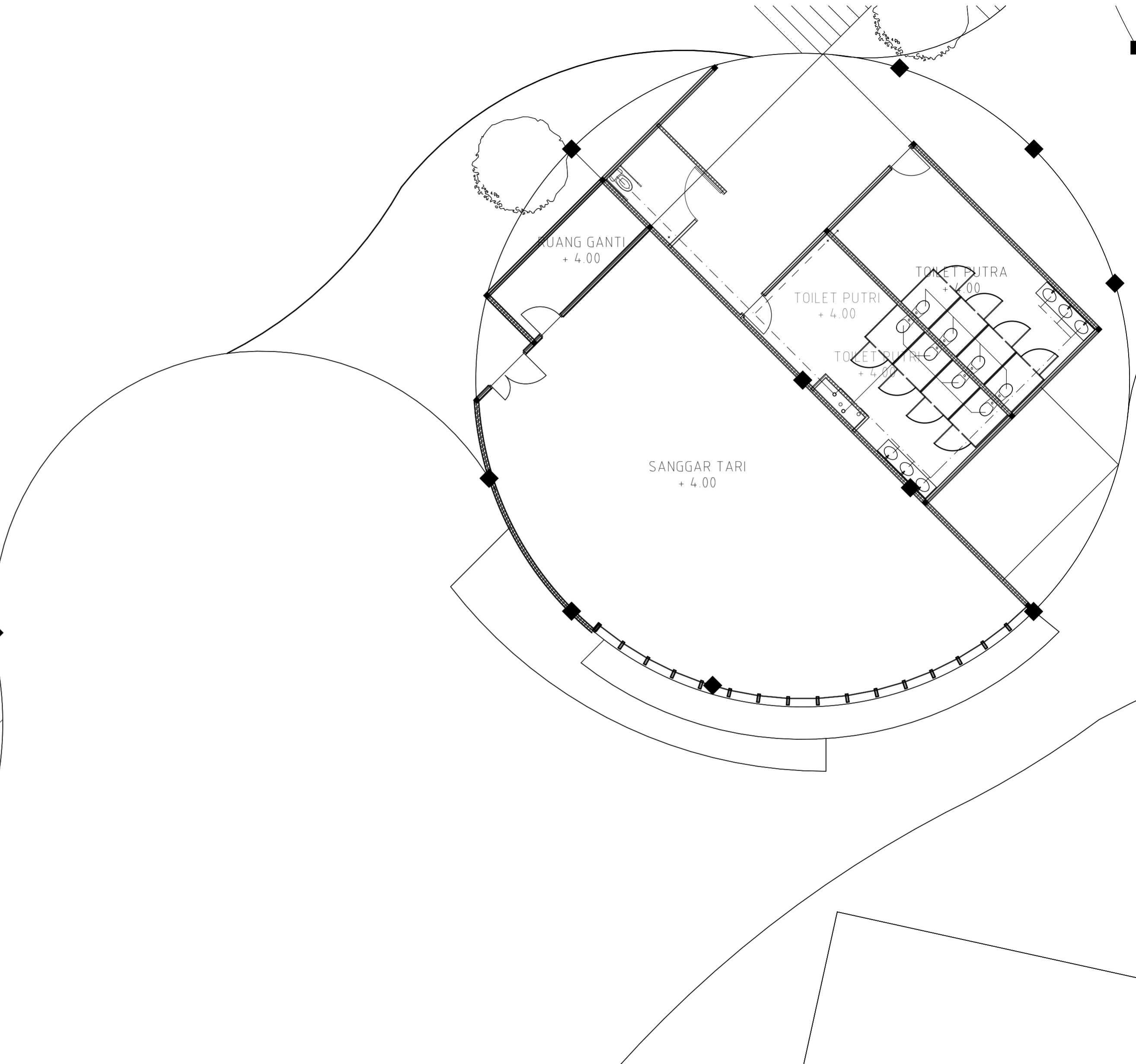
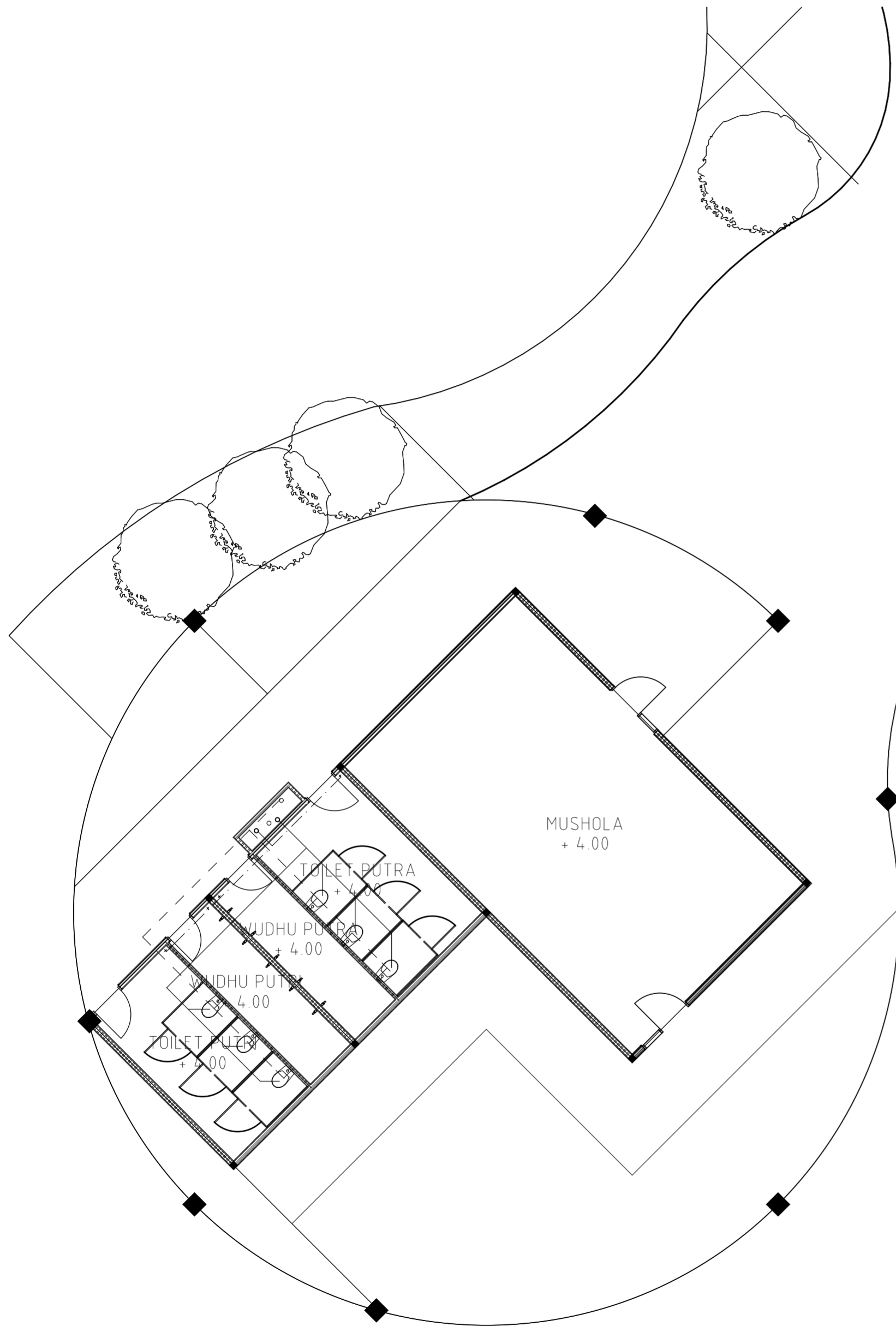

RENCANA AIR KOTOR LANTAI 2
SCALE 1 : 100

	Project Name	Student ID	Drawing Title	Drawing Scale	Sheet Number
	NITIPRAYAN ART AND CULTURAL CENTER	TIDI AYU LESTARI 12512164			
Final Project Title	Project Location	Supervisor	Drawing ID	Total Sheet	
	NITIPRAYAN, BANTUL, YOGYAKARTA	IR. FAJRIYANTO			

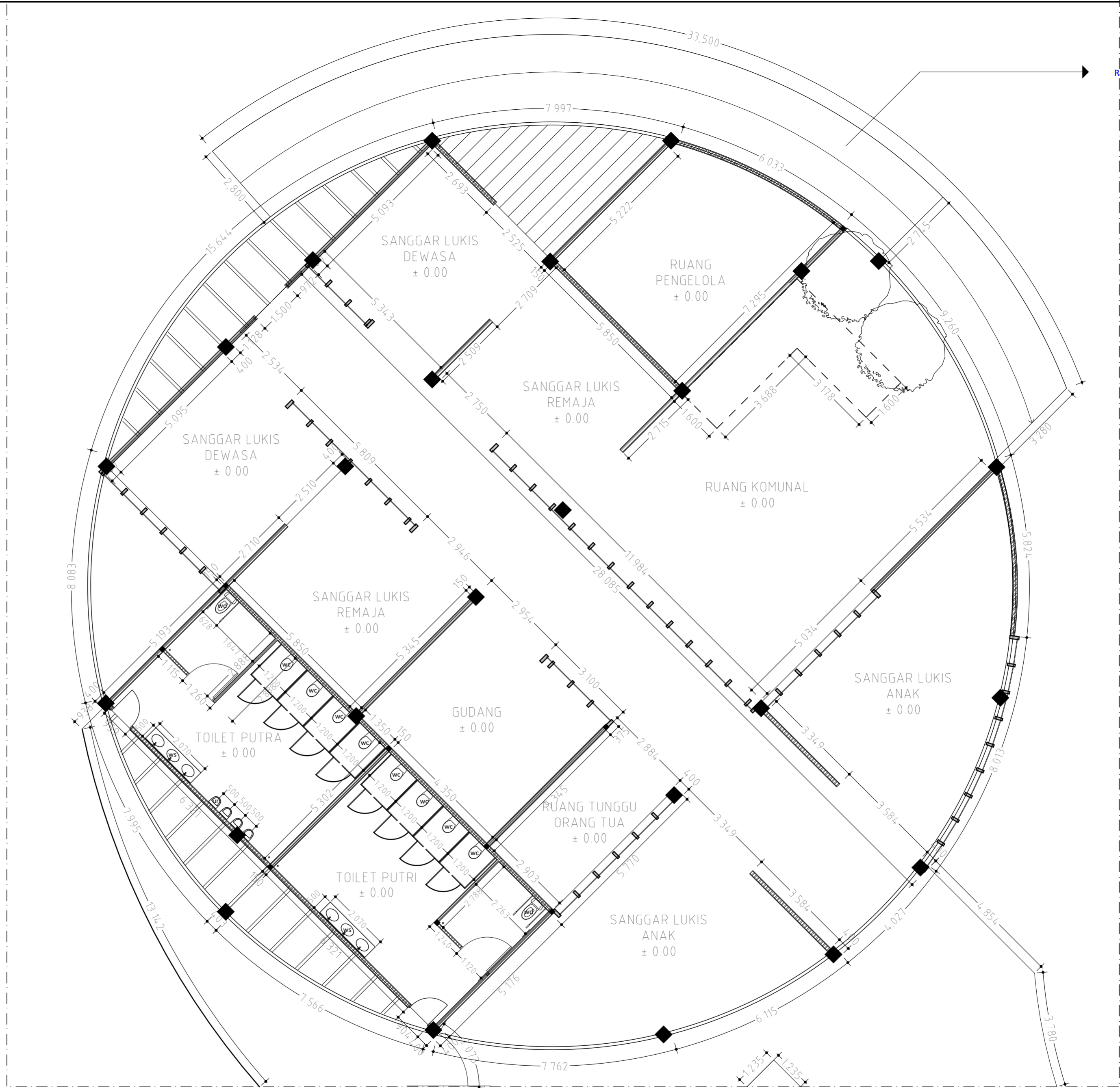
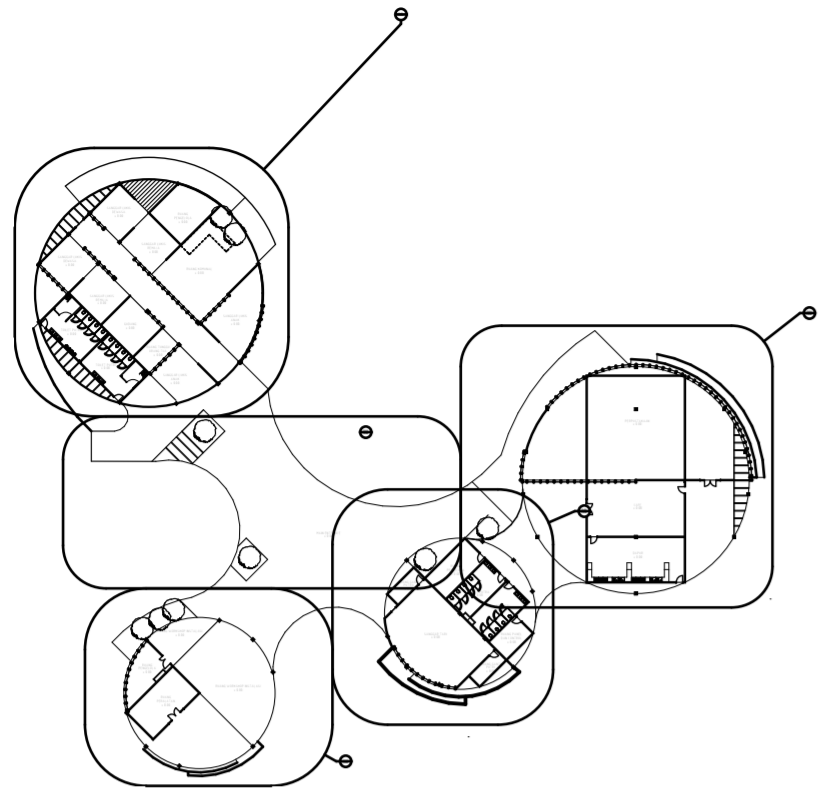

RAMP

KETERANGAN	
Wc	Water Closet
Wd	Water Closet Difable
Ur	Urinoir
Ws	Wastafel
Stv	Stove
Sn	Sink

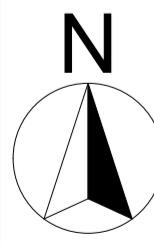
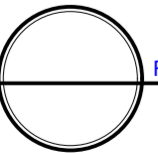

RENCANA AKSES DIFABEL
SCALE 1 : 100

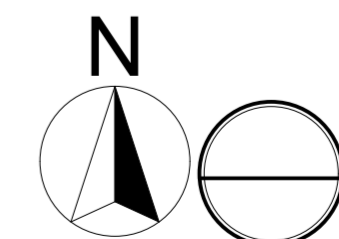
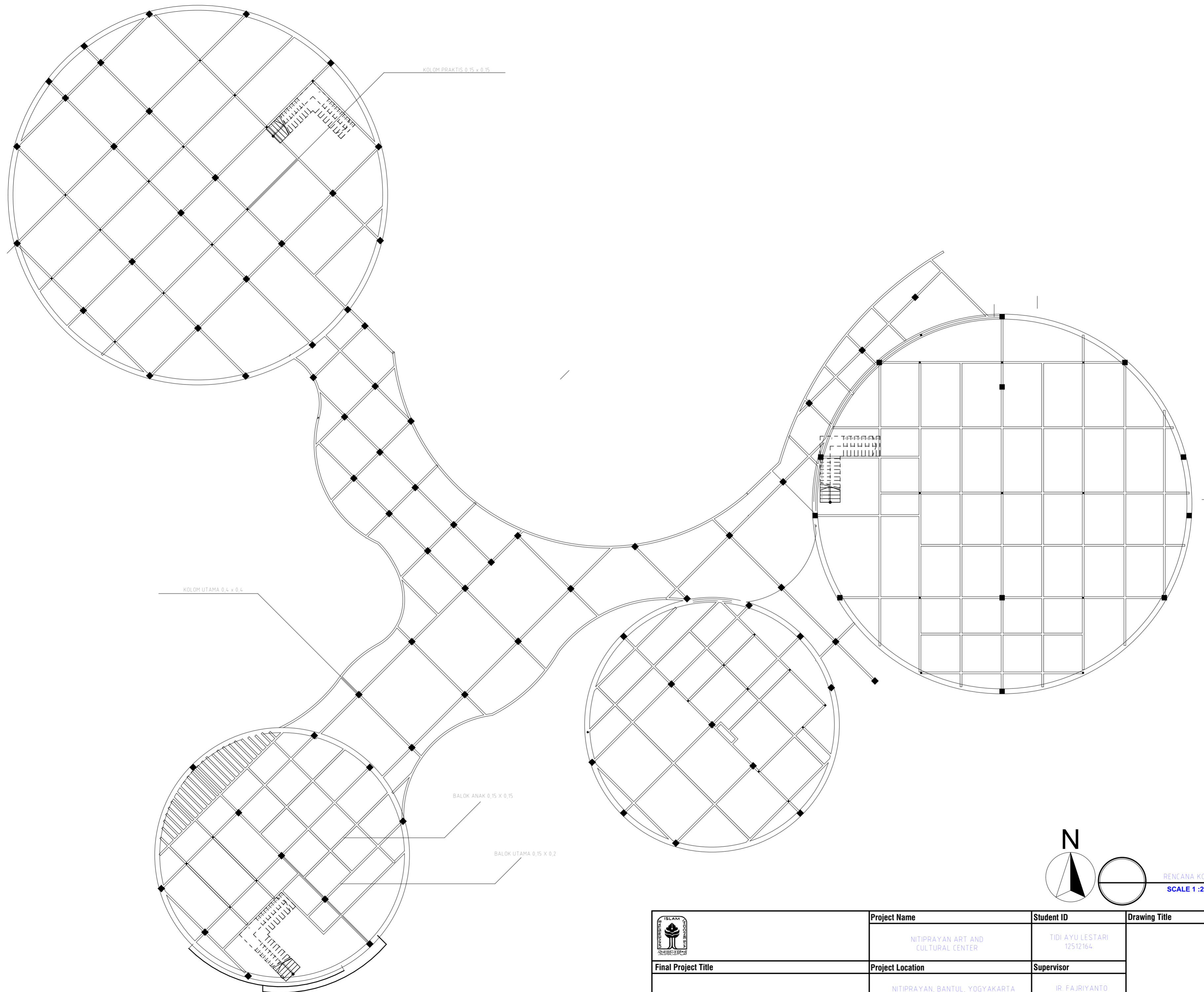
 Final Project Title	Project Name NITIPRAYAN ART AND CULTURAL CENTER	Student ID TIDI AYU LESTARI 12512164	Drawing Title	Drawing Scale	Sheet Number
	Project Location NITIPRAYAN, BANTUL, YOGYAKARTA	Supervisor IR. FAJRIYANTO	Drawing ID	Total Sheet	



RENCANA KOLOM BALOK
SCALE 1 :200

	Project Name	Student ID	Drawing Title	Drawing Scale	Sheet Number
	NITIPRAYAN ART AND CULTURAL CENTER	TIDI AYU LESTARI 12512164			
Final Project Title	Project Location	Supervisor	Drawing ID	Total Sheet	
	NITIPRAYAN, BANTUL, YOGYAKARTA	IR. FAJRIYANTO			

PONDASI/FOOTPLATE 1.8 X 1.8

SLOOF 0.15 X 0.15

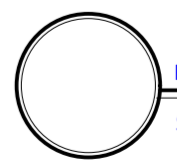
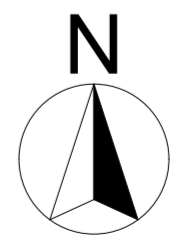
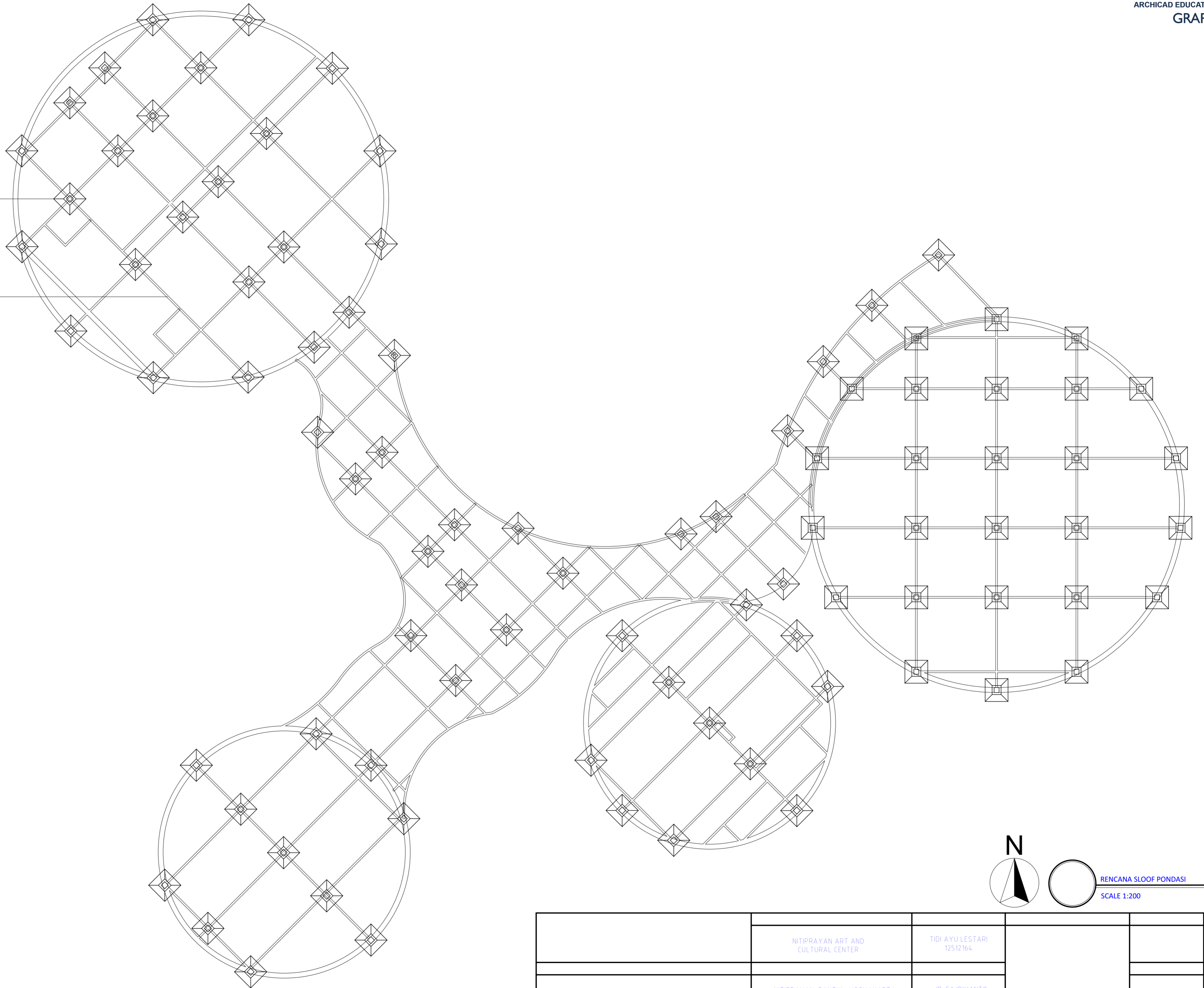

RENCANA SLOOF PONDASI
SCALE 1:200

	NITIPRAN ART AND CULTURAL CENTER	TIDI AYU LESTARI 12512164			
	NITIPRAN, BANTUL, YOGYAKARTA	IR. FAJRIYANTO			



TIDI AYU LESTARI
12512164

Pembimbing : Ir. Fajriyanto

Nitiprayan Art and
Cultural Center
TAMPAK UTARA
SKALA 1:100

Fakultas Teknik Sipil dan Perencanaan
Universitas Islam Indonesia

