

PERPUSTAKAAN FTSP UII	
HADIAH/BELI	
TGL. TERIMA :	4-12-2007
NO. JUDUL :	2660
NO. INV. :	5120002660001
NO. INDUK :	002660

TUGAS AKHIR
**DESAIN PORTAL TRIBUN STADION SLEMAN MEMAKAI
 BAJA DENGAN ANALISIS STRUKTUR PORTAL DUA
 DIMENSI (2D) DAN TIGA DIMENSI (3D)**



AAM HERMAWAN
00.511.228

SYAFRIZAL PUTRA
00.511.320



JURUSAN TEKNIK SIPIL
 FAKULTAS TEKNIK SIPIL DAN PERENCANAAN
 UNIVERSITAS ISLAM INDONESIA
 2007

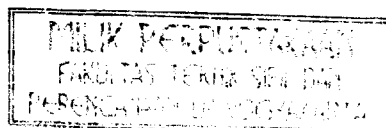

Motto

".....Sesungguhnya Allah tidak akan mengubah keadaan suatu kaum sebelum mereka mengubah keadaan yang ada pada diri mereka sendiri....."

(Q.S Ar rad : 11)

"..... Ya Tuhanku, masukkanlah aku secara masuk yang benar dan keluarkanlah pula aku secara keluar yang benar dan berikanlah aku pertolonganmu"

(Q.S Al Israa : 80)

Mencari kemenangan bukanlah perkara mudah, kejayaan bukanlah perkara kecil, sebab itu belajarlah dan berani kanlah diri tertawa pada waktu dihembus angin. Berani kanlah dan kumpulkanlah kekuatan pada waktu gagal untuk tegak dan melompat sekali lagi, dengan lompat yang lebih keras, sehingga orang yang tadinya tertawa melihat kita jatuh

Bertukar tempat menjadi takjub.

(Hamka)

Halaman Persembahan

Alhamdulillah Rabbil Alamin

Puji dan syukur kehadirat ALLAH SWT yang telah memberikan berkah serta hidayah dan seluruh nikmatnya. Serta memberikan kemudahan dan kelancaran kepada kami sehingga dapat menyelesaikan tugas akhir ini.

Kami persembahkan karya ini untuk :

Orang tua tercinta, yang telah banyak memberikan doa, dorongan dan motivasi yang tiada hentinya. untuk keberhasilan kami ini.

Terima kasih buat

Vira... terimakasih atas perhatian dan kasih sayang mu kepada ku.
Baik-baik kalau di tinggal, tesis nya di kerjain ya.. semoga kita akan selalu bersama.
Novi...terimakasih atas dorongan, memotivasiku dan menjadi salah satu inspirasiku dan penambah semangat bagiku.. semoga kita selalu bersama sampai kesurga.

Ku hanturkan terimakasih kepada...

Seluruh teman-teman kantin amanah: oxem lagi rindu ya cuyy... sabar yaa, dewa lama gak ke kafe stell (tempat mencari inspirasi), sareh he..he..lucu luar dalam kau lae (lahir batin gitu deh), roni gimana pun pasti milan ya lae (milan pasti juara champion), moce udah selesai belum main game nya, jimbonk lantai lima belum di lompat cuy (kapan ni renang lagi), Adi jawa (sesek manuk ku gatele), adi dompu (kau pantas lae jadi orang batak), wawan dompu (bang wan ,kapan2 main futsal lagi kita ya.. rebut juara 1 lagi kita), gandi (komandan ada koleksi bokep baru gak), iwan (pak iwan gimana ni.. biar jadi bos

kaya pak iwan), oni (sayur main batu yuk..), topik (pak de gimana udah kaya belum, yang bagus lempar dadu nya). Mas bemi (fitnes nya masih lanjutkan terus kan biar semangat kerja nya), mas supri (piya masih sering ngajak ngobrol2 ya mas, kalau mau bobo. senang banget ya mas), mbak galuh (mbak galuh ku mirip huges lho..), mbak dewi (ijal doa kan usaha nya lancar ya.. mbak), mami ubay (makasih bu atas nasehat dan doa nya, ”mami bon ijal udah lunas kan mi!!”)

Teman-teman kos jaya kusuma: anggi (Anggita..perut gendut, batak kali muka kau), bagus (susuah ya gus maen game dota nya), andre (basket mania) vijay (tetangga ku idolaku) boy (kemiri nya di pake terus boy, biar lekas tumbuh jempit nya ee..ee sori rambut nya), Furqan (bontang kalau main bola hati2 dengat kontak body nya, ngeri... gede banget), rekta (horas lae..).

Teman-teman sadep: rizoman (takur makin maniz aja senyum nya), deri (ajo..wanggi nya itu lho harum banget), bery (bob,di manakah kau berada!!!) amsal (teman, perjalanan yang panjang), ifan (ipunk, kecil2 lantam.. semangat nya okeh).

Pak susantoro, pak heri terima kasih atas bantuan nya dalam urusan TA, sidang dan pendadaran (insyaALLAH undangan makan ikan bakar nya jadi pak, nanti di konfirmasikan lagi ke bapak, ok..)

Maaf, kalau ada kata-kata tulisan kami yang salah, karena dengan kata-kata ini kami dapat menggigit kalian semua, ini koleksi terbaru yang kami dapatkan. terimakasih banyak segala pengorbanan dan dukungan kalian semua, karena tanpa kalian kami tidak dapat menyelesaikan kewajiban (kuliah) kami ini.

Semua pihak yang tidak dapat kami sebutkan satu persatu terimakasih atas bantuan nya selama ini.

Semoga kita semua selalu bersama

AAM HERMAWAN

SYAFRIZAL PUTRA

5. Orang Tua dan Keluarga atas do'a dan cintanya yang telah memberikan dorongan untuk menyelesaikan tugas akhir ini.
6. Perumahan Persero (PP) kontraktor atas kerjasama dan bantuan data-data penting yang mendukung terselesaikannya tugas akhir ini.
7. Teman-teman Kos POHI dan komunitas kantin Amanah atas dukungan dan segala bentuk bantuannya.

Kami menyadari bahwa penyusunan laporan ini masih ada kekurangan, karena keterbatasan kemampuan kami. Untuk itu kami selalu terbuka terhadap segala saran dan kritik yang membangun demi kesempurnaan laporan ini.

Semoga apa yang tersaji dalam laporan ini dapat memberikan suatu wacana baru bagi semua pihak dalam dunia keteknik sipil.

Yogyakarta, April 2007

Penyusun

DAFTAR ISI

	Halaman
Lembar Pengesahan	i
Kata Pengantar	ii
Daftar Isi	iv
Daftar Gambar	vii
Daftar Tabel	ix
Daftar Lampiran	x
Daftar Notasi	xi
BAB I PENDAHULUAN	
1.1. Latar Belakang	1
1.2. Rumusan Masalah	2
1.3. Tujuan	2
1.4. Manfaat	2
1.5. Batasan Perencanaan	3
BAB II TINJAUAN PUSTAKA	
2.1. Baja Struktur	4
2.2. Struktur Rangka	4
2.3. Struktur Portal Bidang dan Portal Ruang	4
2.4. Beban-Beban Pada Struktur	5
2.5. Perencanaan Struktur Baja	5
2.5.1. Metode Load Resistance Factor Design (LRFD)	5
2.5.2. Metode Statik Ekuivalen	5
2.5.3. Rangka Kaku	6
2.5.4. Baut Kekuatan Tinggi (A325)	6
2.5.5. Sambungan Las	6
2.5.6. Sambungan Kaku	7

BAB III LANDASAN TEORI

3.1. Pembebanan	8
3.1.1. Beban Mati (Dead Load)	8
3.1.2. Beban Hidup (Live Load)	8
3.1.3. Beban Gempa (Quake Load)	8
3.2. Sistem Koordinat	12
3.2.1. Sistem Koordinat Global	13
3.2.2. Sistem Koordinat Lokal	14
3.3. Perencanaan Struktur Baja Dengan Metode LRFD	18
3.3.1. Kombinasi Pembebanan Dalam LRFD	18
3.3.2. Perencanaan Balok	19
3.3.3. Perencanaan Kolom	22
3.3.5. Perencanaan Sambungan Balok Dengan Kolom	25
3.3.6. Perencanaan Sambungan Kolom Dengan Kolom	29
3.3.7. Perencanaan Pelat Dasar Kolom	32
3.3.8. Perencanaan Pedestal (Kaki Kolom)	35

BAB IV METODE PENELITIAN

4.1. Data Struktur	36
4.2. Tahapan Analisis	40
4.2.1. Flow Chart Tahapan Analisis	41
4.2.2. Flow Chart SAP	43

BAB V ANALISIS DAN DESAIN STRUKTUR

5.1. Perencanaan Awal (Preliminary Design)	44
5.2. Pembebanan	47
5.2.1. Beban Gravitasi	48
5.2.2. Beban Gempa	66
5.3. Perencanaan Balok	71
5.3.1. Perencanaan Lentur Balok	71
5.3.2. Gaya Geser Rencana Balok	77

5.3.3. Kuat Geser Nominal Balok	79
5.4. Perencanaan Kolom	82
5.4.1. Momen Rencana Kolom (Mu,k)	82
5.4.2. Gaya Aksial Rencana Kolom	84
5.4.3. Gaya Geser Rencana Kolom	85
5.4.4. Perencanaan Kolom Terhadap Momen dan Gaya Aksial	86
5.4.5. Perencanaan Kolom Terhadap Geser	88
5.5. Perencanaan Sambungan	90
5.5.1. Sambungan Balok Dengan Kolom	90
5.5.3. Perencanaan Sambungan Kolom Dengan Kolom	96
5.5.4. Perencanaan Pelat Dasar Kolom	99
5.5.5. Perencanaan Pedestal (Kaki Kolom)	104
BAB VI HASIL DAN PEMBAHASAN	
6.1. Momen dan Gaya geser balok	106
6.2. Momen, Gaya Aksial dan Gaya geser Kolom	110
6.3. Rasio Momen dan Gaya geser balok.....	113
6.4 Rasio Momen, Gaya Aksial dan Gaya geser Kolom.....	115
6.5. Berat Struktur	117
BAB VI KESIMPULAN DAN SARAN	
7.1. Kesimpulan	121
7.2. Saran	122
DAFTAR PUSTAKA	123

DAFTAR GAMBAR

Gambar 3.1 Koefisien Gempa Dasar	10
Gambar 3.2 Menentukan Sudut Putar <i>ang</i>	15
Gambar 3.3 Menentukan Sudut Putar <i>ang</i>	15
Gambar 3.4 Menentukan Sudut Putar <i>ang</i>	16
Gambar 4.1 Denah Struktur Tribun Bangunan	36
Gambar 4.2 Denah Struktur Tribun Blok Utara	37
Gambar 4.3 Potongan I – I	38
Gambar 4.4 Memanjang Portal 1	38
Gambar 4.5 Memanjang Portal 2	39
Gambar 4.6 Memanjang Portal 3	39
Gambar 4.7 Flow Chart Tahapan Analisis	41
Gambar 4.8 Flow Chart SAP 200	43
Gambar 5.1 Denah Pola Balok (Elevasi Lantai +2.500)	44
Gambar 5.2 Denah Pola Balok (Elevasi Lantai +5.000)	45
Gambar 5.4 Denah Pola Balok Miring	46
Gambar 5.5 Distribusi Beban	49
Gambar 5.6 Distribusi Beban	50
Gambar 5.7 Pembebanan Balok Portal 1	50
Gambar 5.8 Distribusi Beban Titik Portal 1	52
Gambar 5.9 Pembebanan Balok Portal 2	55
Gambar 5.10 Distribusi Beban Titik Portal 1	58
Gambar 5.12 Bending Momen	71
Gambar 5.13 Pola Balok Lantai 1	80
Gambar 5.14 Hasil Desain Balok dan Kolom	89
Gambar 5.15 Rencana Sambungan Yang Digunakan	92
Gambar 6.1 Struktur Portal Arah Melintang	106
Gambar 6.2 Momen Balok Portal B Analisis 2D dan 3D	108
Gambar 6.3 Momen Balok Portal 1 Analisis 2D dan 3D	108
Gambar 6.4 Gaya Geser Balok Portal B Analisis 2D dan 3D	109

Gambar 6.5 Gaya Geser Balok Portal I Analisis 2D dan 3D	109
Gambar 6.6 Momen Kolom K3 Arah X Analisis 2D Terhadap 3D	110
Gambar 6.7 Momen Kolom K3 Arah Y Analisis 2D Terhadap 3D	110

DAFTAR TABEL

Tabel 5.1 Hitungan Gaya Horizontal Akibat Gempa Portal C	90
Tabel 5.2 Rekapitulasi Profil Balok Lantai 1	104
Tabel 5.2 Rekapitulasi Profil Balok Lantai 2	105
Tabel 5.2 Rekapitulasi Profil Balok Lantai 3	105
Tabel 5.5 Angka Kekakuan	107
Tabel 5.6 Kekakuan Kolom	110

DAFTAR LAMPIRAN

- Lampiran A : Momen, Gaya Aksial dan Gaya Geser Balok
- Lampiran B : Momen, Gaya Aksial dan Gaya Geser Kolom
- Lampiran C : Perhitungan Beban Gempa
- Lampiran D : Desain Balok
- Lampiran E : Desain Kolom

DAFTAR NOTASI

A	Adalah luas penampang, mm ²
Ab	Adalah Luas Penampang Bruto, mm ²
Ae	Adalah luas penampang efektif, mm ²
Af	Adalah luas efektif penampang sayap, mm ²
Aw	Adalah luas pelat badan, mm ²
bf	Adalah lebar pelat sayap, mm
Cb	Adalah Koefisien pengali momen tekuk torsi lateral
C	Koefisien gempa dasar
D	Adalah beban mati yang diakibatkan oleh berat konstruksi permanen, termasuk dinding, lantai, atap, plafon, partisi tetap, tangga, dan peralatan layan tetap.
d	Adalah tinggi penampang, mm
E	Adalah beban gempa
E	Adalah Modulus elastisitas baja, Mpa
Fi	adalah gaya geser dasar akibat gempa lantai ke-i
Fcr	Adalah tegangan kritis, KN
fy	Adalah tegangan leleh material, Mpa
fr	Adalah tegangan sisa, Mpa
fu	Adalah tegangan tarik putus, Mpa
G	Adalah modulus geser baja, Mpa
G	Adalah perbandingan total kekakuan kolom dalam suatu join terhadap kekakuan balok dalam suatu join yang sama.
Ii	Adalah tinggi lantai ke-i
H	Adalah tinggi keseluruhan bangunan, m
hn	Adalah tinggi bersih kolom, m
h	Adalah tinggi kolom dari as ke as, m
I	Adalah faktor keutamaan struktur
I	Adalah Momen Inersia, N-mm

I_w	Adalah Konstanta puntir lengkung
J	Adalah konstanta puntir torsi
K	Adalah faktor panjang tekuk
kn	Adalah tebal pelat sayap ditambah jari-jari peralihan, mm
L	Adalah beban hidup yang ditimbulkan oleh penggunaan gedung, termasuk kejutan, tetapi tidak termasuk beban lingkungan seperti angin, hujan, dan lain-lain.
L	Adalah lebar total bangunan, m
L_b	Adalah Panjang bentang antara dua pengekang lateral yang berdekatan, mm
L_p	Adalah panjang bentang maksimum untuk balok yang mampu menerima momen plastis, mm
L_r	Adalah panjang bentang minimum untuk balok yang kekuatannya mulai ditentukan oleh momen kritis tekuk torsi lateral, mm
M_u	Adalah momen lentur perlu, N-mm
M_{cr}	Adalah momen kritis terhadap tekuk torsi lateral, N-mm
M_p	Adalah momen lentur yang menyebabkan seluruh penampang mengalami tegangan leleh, N-mm
M_r	Adalah momen batas tekuk, N-mm
M_n	Adalah Kuat lentur nominal balok, N-mm
M_{max}	Adalah momen maksimum pada bentang yang ditinjau, N-mm
M_A	Adalah momen pada seperempat bentang, N-mm
M_B	Adalah momen pada setengah bentang, N-mm
M_C	Adalah momen pada tigaperempat bentang, N-mm
N_u	Adalah gaya tarik aksial terfaktor, KN
N_n	Adalah kuat tarik nominal balok, KN
R_u	Adalah beban terfaktor atau kuat perlu
R_y	Adalah faktor modifikasi tegangan leleh, N
r_y	Adalah jari-jari girasi terhadap sumbu lemah, mm
ϕR_n	Adalah Kuat Rencana
ϕR_n	Adalah Kuat tumpu satu baut, KN

S	Adalah modulus penampang, mm ³
t _f	Adalah tebal pelat sayap, mm
t _w	Adalah tebal pelat badan, mm
T _n	Adalah gaya tarik/tekan nominal, KN
T _u	Adalah gaya tarik/tekan terfaktor, KN
U	Adalah koefisien reduksi = 1 untuk elemen penghubung
V _b	Adalah gaya geser dasar total akibat gempa, N
V _u	Adalah gaya geser perlu, N
V _n	Adalah kuat geser nominal, N
W _i	Adalah berat lantai ke-i
X ₁	Adalah koefisien untuk perhitungan momen tekuk torsi lateral, Mpa
X ₂	Adalah koefisien untuk perhitungan momen tekuk torsi lateral, (1/Mpa) ²
Z	Adalah modulus penampang plastis, mm ³
φ	Adalah faktor reduksi
φ _b	Adalah faktor reduksi kuat lentur
α	Adalah faktor distribusi momen kolom portal yang ditinjau sesuai kekakuan relatif kolom atas dan kolom bawah

TUGAS AKHIR
DESAIN PORTAL TRIBUN STADION SLEMAN MEMAKAI
BAJA DENGAN ANALISIS STRUKTUR PORTAL DUA
DIMENSI (2D) DAN TIGA DIMENSI (3D)

Disusun oleh:
AAM HERMAWAN
00.511.228

SYAFRIZAL PUTRA
00.511.320

Disetujui:

Pembimbing I



(Ir.H. Suharyatmo, MT)

Tanggal:

1/5/07

Pembimbing II



(Ir. Fatkhurrohman N, MT)

Tanggal:

BAB I

PENDAHULUAN

1.1 Latar Belakang

Struktur stadion Sleman yang sekarang ada, dibuat dari beton bertulang dengan pertimbangan material beton (pasir dan kerikil) banyak terdapat di daerah istimewa Jogjakarta. Pelaksanaan pekerjaan beton bertulang membutuhkan waktu relatif lama karena harus menunggu proses pengerasan. Apabila waktu pelaksanaan mendesak maka sebagai alternatif struktur dapat dirancang dengan baja.

Baja digunakan sebagai alternatif dalam perencanaan stadion Sleman dengan pertimbangan bahwa baja mempunyai kekuatan yang relatif tinggi sehingga penampang struktur baja relatif kecil dan berat sendiri bangunannya dapat lebih ringan dibanding struktur beton, selain itu waktu pelaksanaan struktur baja relatif singkat.

Struktur stadion Sleman dapat diasumsikan sebagai struktur rangka bidang atau dua dimensi (2D) dan struktur rangka ruang atau tiga dimensi (3D). Perbedaan asumsi mengakibatkan perbedaan hasil analisis (momen, gaya aksial dan gaya geser) yang bekerja pada setiap komponen struktur, sehingga mengakibatkan perbedaan ukuran penampang. Guna mengetahui perbedaan hasil analisis dan desain di atas perlu dilakukan kajian secara numeris.

1.2 Rumusan Masalah

Permasalahan yang dapat dirumuskan dalam penulisan tugas akhir ini adalah seberapa besar perbedaan berat struktur bangunan antara struktur yang didesain dengan struktur rangka bidang atau dua dimensi (2D) dan struktur yang didesain dengan struktur rangka ruang atau tiga dimensi (3D).

1.3 Tujuan

Tujuan dari penulisan tugas akhir ini adalah sebagai berikut :

1. Mendapatkan hasil analisis (momen, gaya aksial, dan gaya geser) dan dimensi penampang setiap komponen struktur (balok dan kolom) dengan tinjauan struktur rangka bidang atau dua dimensi (2D) dan struktur rangka ruang atau tiga dimensi (3D).
2. Membandingkan berat struktur bangunan antara struktur yang didesain dengan struktur rangka bidang atau dua dimensi (2D) dan struktur struktur rangka ruang atau tiga dimensi (3D).

1.4 Manfaat

Manfaat dari penulisan tugas akhir ini adalah sebagai berikut :

1. Memberikan informasi kepada semua pihak yang berkepentingan tentang alternatif lain dalam mendesain struktur portal tribun stadion yang aman dan efisien.
2. Menambah pengetahuan yang lebih mendalam di bidang struktur terutama dalam perencanaan konstruksi baja stadion.

1.5 Batasan Perencanaan

Batasan perencanaan dalam penyusunan tugas akhir ini adalah sebagai berikut :

1. Obyek perencanaan struktur adalah tribun stadion Sleman Jogjakarta sayap utara (tanpa atap).
2. Perencanaan komponen struktur menggunakan metode Load Resistance Factor Design (LRFD), sesuai yang dikemukakan American institute of steel construction (AISC).
3. Komponen portal (Balok dan kolom) menggunakan baja A36, tegangan leleh (F_y) = 240Mpa dan tegangan ultimit (F_u) = 400 Mpa
4. Sambungan balok dengan kolom menggunakan las dan baut.
5. Pelat lantai tidak komposit dengan balok.
6. Hubungan struktur dengan tanah diasumsikan jepit.
7. Pembebanan struktur menggunakan Pedoman Perencanaan Pembebanan Untuk Rumah dan Gedung 1987.
8. Beban gempa menggunakan beban horizontal dengan metode statik ekuivalen yang mengacu pada Peraturan Perencanaan Tahan Gempa Indonesia untuk Gedung 1987.

BAB II

TINJAUAN PUSTAKA

2.1 Baja Struktur

Baja bangunan (*steel structural*) termasuk material daktail (*ductile*), artinya mampu mengalami deformasi inelastis besar sebelum runtuh. Sifat baja dapat dikenali dari diagram tegangan-regangan (*stress-strain diagram*) hasil uji uniaksial. (Fatkhurrohman N, 2003)

2.2 Struktur Rangka

Struktur rangka (*Framed structure*) adalah struktur yang elemennya terdiri dari batang-batang tarik, balok dan batang-batang yang mendapatkan beban lentur kombinasi dan beban aksial, yang terhubung secara kaku (*rigid*) atau hanya terhubung sederhana dengan penopang diagonal untuk menjaga stabilitas. (Salmon dan Johnson, 1992).

2.3 Struktur portal bidang dan portal ruang

Struktur portal bidang adalah struktur yang memiliki kelakuan yang jauh lebih besar dalam salah satu arah di bandingkan arah lainnya, dan struktur portal ruang adalah struktur yang kerangkanya memiliki kelakuan batang dalam salah satu bidang yang berpengaruh terhadap kelakuan dalam bidang yang lain. (Salmon dan Johnson, 1994)

2.4 Beban-Beban Pada Struktur

Beban-beban yang terdapat pada struktur adalah beban mati (*Dead Load*), beban hidup (*Live Load*) dan beban gempa (*Quake Load*).

Beban mati merupakan beban gaya berat pada suatu posisi tertentu atau bekerja terus menerus menuju arah bumi pada saat struktur telah berfungsi.

Beban hidup adalah beban gravitasi pada struktur yang ditimbulkan oleh penggunaan gedung, yang besar dan lokasinya bervariasi.

Beban gempa adalah beban yang diakibatkan pergerakan tanah dalam arah mendatar dan vertikal, dengan besar gerak vertikal yang umumnya jauh lebih kecil. (Salmon dan Johnson, 1994)

2.5 Perencanaan Struktur Baja

2.5.1 Metode Load Resistance Factor Design (LRFD)

Load Resistance Factor Design (LRFD) adalah metode yang digunakan dalam merencanakan struktur berdasarkan pada keadaan batas, dimana suatu struktur akan berhenti memenuhi fungsi yang diharapkan darinya (Salmon dan Johnson, 1996).

2.5.2 Metode Statik Ekuivalen

Beban statik ekuivalen adalah representasi dari beban gempa yang telah disederhanakan, yaitu penyederhanaan gaya inersia yang bekerja pada suatu massa yang disederhanakan menjadi suatu beban statik. Analisis beban static ekuivalen adalah suatu cara analisa statik struktur, pengaruh gempa pada struktur dianggap sebagai beban-beban statik

horizontal untuk menirukan pengaruh gempa yang sesungguhnya akibat gerakan tanah.

(Tata Cara Perencanaan Pembebanan Untuk Rumah dan Gedung 1989).

2.5.3 Rangka Kaku

Rangka Kaku adalah suatu rangka struktur yang gaya-gaya lateralnya dipikul oleh system struktur dengan sambungan-sambungannya direncanakan secara kaku dan komponen strukturnya direncanakan untuk memikul efek gaya aksial, gaya geser, gaya lentur dan torsi.

(Tata Cara Perencanaan Struktur Baja Untuk Bangunan Gedung 2000)

2.5.4 Baut Kekuatan Tinggi (A325)

Baut A325 biasa disebut baut struktural berkekuatan tinggi. Material ini mengandung karbon maksimum sebesar 0,3 % dan mendapat perlakuan panas (pendinginan) dan kemudian dipanaskan kembali (penyepuhan) sampai temperature paling tidak sebesar 800⁰ F. (Salmon dan Johnson, 1992).

2.5.5 Sambungan Las

Sering kali mudah membuat sambungan las dari pada membuat sambungan baut. Akan tetapi, didalam sambungan kerangka sambungan tersebut biasanya akan memerlukan baut-baut penegakan baik didalam plat penegakan sementara atau permanent maupun didalam profil siku untuk memegang bagian-bagian konstruksi selama penjajaran dan selama pemasangan perangkat acuan ulang untuk pengelasan tersebut. (Joseph E.Bowles, 1985).

2.5.6 Sambungan kaku

Sambungan kaku memiliki kontinuitas penuh sehingga sudut pertemuan antara batang-batang tidak berubah, yakni pengekangan (restrain) rotasi sekitar 90 % atau lebih dari yang diperlukan untuk mencegah perubahan sudut. (Salmon dan Johnson, 1992).

BAB III

LANDASAN TEORI

3.1 Pembebanan

Beban-beban yang bekerja pada struktur stadion Sleman adalah beban mati (*Dead Load*), beban hidup (*Live Load*) dan beban gempa (*Quake Load*).

3.1.1 Beban Mati (*Dead Load*)

Beban mati yang diakibatkan oleh berat konstruksi permanen, termasuk dinding, lantai, atap, plafon, partisi tetap, tangga, dan peralatan layan tetap.

3.1.2 Beban Hidup

Beban hidup yang ditimbulkan oleh penggunaan gedung, termasuk kejut, tetapi tidak termasuk beban lingkungan seperti angin, hujan dan lain-lain.

3.1.3 Beban Gempa

Faktor-faktor penentu beban gempa rencana dengan metode statik ekivalen

Beban statik ekivalen adalah representasi dari beban gempa yang telah disederhanakan, yaitu penyederhanaan gaya inersia yang bekerja pada suatu massa yang disederhanakan menjadi suatu beban statik. Gaya inersia adalah suatu gaya yang bekerja pada suatu massa dengan arah yang berlawanan dengan arah gerakan massa yang bersangkutan

oleh adanya beban dinamis gempa. Jadi beban statik ekuivalen merupakan beban yang ekuivalen dengan beban gempa yang bekerja pada bangunan dalam batas tidak terjadi *overstress*.

Walaupun sifatnya merupakan penyederhanaan, tetapi bukan berarti bahwa metode statik ekuivalen tidak berdasar, karena beban tersebut sudah berdasar pada prinsip-prinsip dinamis, seperti dinamik karakteristik bangunan, jenis struktur (K) dan peruntukan bangunan (I). Dinamik karakteristik bangunan meliputi massa (M), kekakuan (K) dan redaman (Cc). Dalam konsep statik ekuivalen hanya massa yang diperhitungkan dan inilah yang menjadi perbedaan utama antara konsep statis dan konsep dinamis.

Beban geser dasar akibat gempa

Peraturan-peraturan perencanaan bangunan tahan gempa yang berlaku menetapkan suatu taraf beban gempa rencana yang menjamin suatu struktur tidak akan rusak pada saat dilanda gempa kecil atau sedang dan pada saat dilanda gempa kuat yang jarang terjadi. Struktur tersebut harus mampu berperilaku duktail dengan memancarkan energi gempa dan sekaligus membatasi beban gempa yang masuk kedalam struktur.

Setiap struktur gedung harus direncanakan dan dilaksanakan untuk menahan suatu beban geser dasar akibat gempa (V). Besarnya beban geser rencana (V) menurut Pedoman Perencanaan Ketahanan

Gempa untuk Rumah dan Gedung 1987 dapat dinyatakan sebagai berikut :

$$V = C \cdot I \cdot K \cdot W_t \dots\dots\dots (3.1)$$

dengan : V = Gaya geser dasar horizontal total akibat gempa

C = Koefisien gempa dasar, I = Faktor keutamaan struktur

K = Faktor jenis struktur , W_t = Berat total bangunan

Nilai koefisien gempa dasar (C) dipengaruhi oleh periode getar struktur (T). Cara mencari koefisien gempa dasar adalah dengan menggunakan grafik respon spektrum seperti ditunjukkan pada gambar 3.1 dibawah ini.

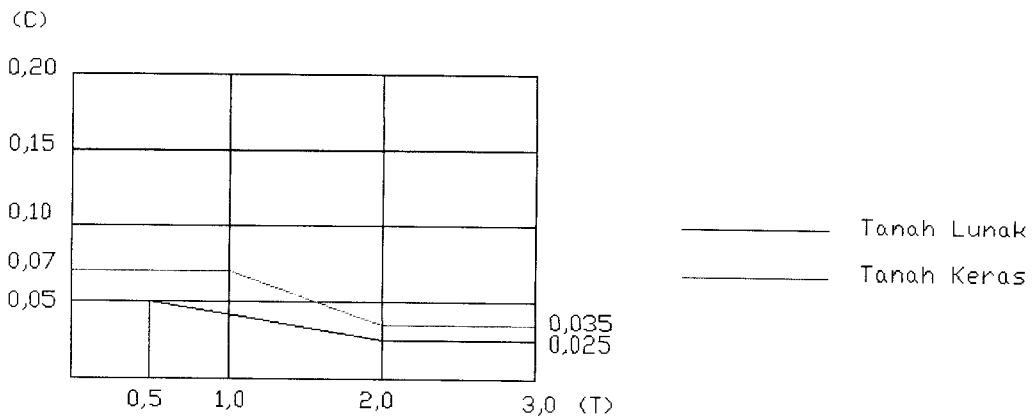

Gambar 3.1 koefisien gempa dasar (C)

Untuk struktur baja periode getar struktur dihitung dengan rumus $T = 0,08.H^{3/4}$ dengan H adalah tinggi total bangunan.

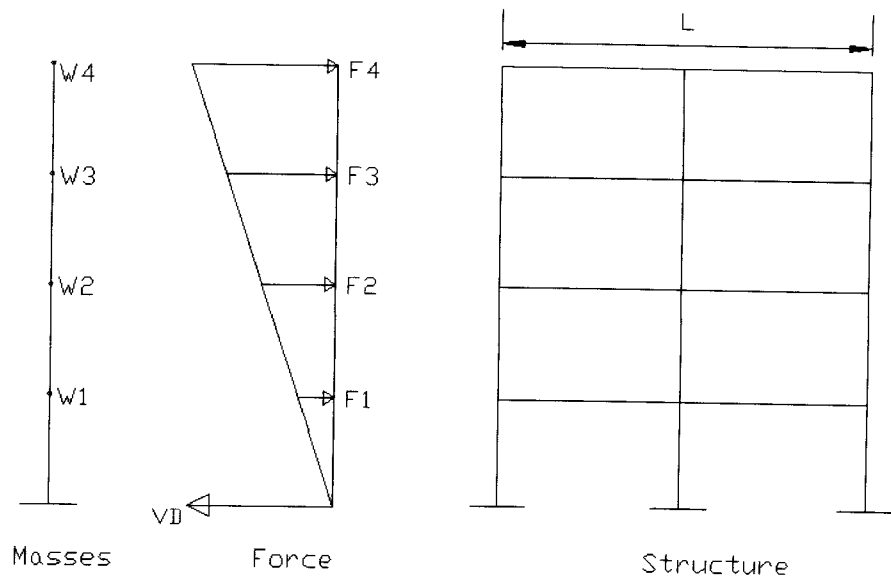

Gambar 3.2 Massa, gaya dan struktur

Distribusi gaya geser horizontal akibat gempa ke sepanjang tinggi gedung menurut Pedoman Perencanaan Ketahanan Gempa untuk Rumah dan Gedung 1987 dihitung dengan persamaan berikut ini :

$$\text{Untuk } \frac{H}{L} \geq 3 \quad F_i = \frac{w_i \cdot h_i}{\sum w_i \cdot h_i} \cdot 0,9 \cdot V_b \dots\dots\dots (3.2)$$

Gaya geser sebesar 0,1.V ditambahkan pada F_i lantai paling atas

$$\text{Untuk } \frac{H}{L} < 3 \quad F_i = \frac{w_i \cdot h_i}{\sum w_i \cdot h_i} \cdot V_b \dots\dots\dots (3.3)$$

dengan : F_i = Gaya geser dasar akibat gempa lantai ke - i,

H_i = Tinggi lantai ke-i terhadap lantai dasar,

W_i = berat lantai ke - i, V_b = Gaya geser dasar total akibat gempa, L = Lebar total bangunan , H = Tinggi keseluruhan bangunan

Pembebanan gempa horizontal terhadap portal 2D dan 3D

Gempa horizontal yang bekerja pada portal 2D bekerja hanya pada satu arah saja sedangkan pada portal 3D beban gempa horizontal bekerja pada 2 arah yang saling tegak lurus, artinya gempa arah x dikerjakan pada unsur dalam arah itu dikombinasikan dengan pengaruh gempa arah y dikerjakan tegak lurus dengan arah x (PPKGURDG, 1987). Menurut PPKGURDG, 1987 beban gempa yang bekerja dalam masing-masing arah utama dengan dikombinasi dengan 0,3 beban gempa yang bekerja pada arah tegak lurus pada arah utama yang ditinjau. Kombinasi yang menghasilkan pengerahan kekuatan unsur yang maksimum adalah yang ditinjau atau dapat ditulis sebagai berikut :

- Gravitasi ± 100 % gempa arah x ± 30 % gempa arah y
- Gravitasi ± 30 % gempa arah x ± 100 % gempa arah y

Pada penulisan tugas akhir ini pembebanan pada struktur 3D dicoba dengan pembebanan yang sama besar dan arahnya dengan pembebanan struktur 2D.

3.2 Sistem Koordinat

Setiap model struktur menggunakan koordinat yang berbeda untuk menentukan joint dan arah beban, *displacements*, gaya dalam dan tegangan. Pengetahuan tentang sistem koordinat ini sangat penting dalam pemodelan struktur, baik pemodelan struktur 2 (dua) dimensi maupun pemodelan struktur 3 (tiga) dimensi, karena dalam menentukan model dan menginterpretasikan

hasil-hasil keluaran dari program, perencana harus mengetahui tentang sistem koordinat ini.

Semua sistem koordinat pada model ditentukan dengan mematuhi satu sistem koordinat global **X-Y-Z**. Setiap bagian dari model misalnya joint, elemen atau konstrain. Masing-masing mempunyai sistem koordinat lokal **1-2-3**. semua sistem koordinat ditunjukkan dengan sumbu tiga dimensi, menggunakan aturan tangan kanan dan menggunakan sistem *cartesian* (segi empat).

SAP selalu mengasumsikan sumbu **Z** ialah sumbu vertikal, dengan **Z+** mengarah keatas. Arah keatas digunakan sebagai bantuan untuk menentukan sistem koordinat lokal itu sendiri tidak mempunyai sumbu arah vertikal.

3.2.1 Sistem koordinat Global

Sistem koordinat global merupakan koordinat dalam tiga dimensi, mengikuti aturan tangan kanan (*right handed*), dan merupakan koordinat *cartesian* (segi-empat). Tiga sumbu dengan notasi **X**, **Y** dan **Z** ialah sumbu yang saling tegak lurus sesuai dengan aturan tangan kanan. Letak dan orientasi sumbu global tersebut dapat berubah-ubah, misalkan sesuai dengan aturan tangan kanan.

Lokasi pada sistem koordinat global dapat ditentukan menggunakan variabel **X**, **Y** dan **Z**. Vektor dalam sistem koordinat global atau dengan memberikan arah koordinat. Arah koordinat ditunjukkan dengan nilai **X \pm** , **Y \pm** dan **Z \pm** . Sebagai contoh **X+**

menunjukkan vektor sejajar dan searah dengan dengan sumbu X positif. Semua sistem koordinat yang lain pada model ditentukan berdasarkan sistem koordinat global ini.

SAP selalu mengasumsikan sumbu Z arahnya vertikal, dengan Z+ arah keatas. Sistem koordinat lokal untuk joint, elemen, dan gaya percepatan tanah ditentukan berdasarkan arah keatas tersebut. Beban berat sendiri arahnya selalu kebawah, pada arah Z-.

Bidang X-Y merupakan bidang horizontal.dengan sumbu X+ merupakan sumbu utama. Sudut pada bidang horizontal diukur dari sumbu positif X, dengan sudut positif ialah berlawanan arah dengan arah putaran jarum jam.

3.2.2 Sistem Koordinat Lokal

Pada setiap elemen frame mempunyai sistem koordinat lokal yang digunakan untuk menentukan potongan property, beban dan gaya keluaran. Sumbu – sumbu koordinat lokal ini dinyatakan dengan simbol 1, 2 dan 3. Sumbu 1 arahnya ialah searah sumbu elemen, dua sumbu yang lain tegak lurus dengan elemen tersebut dan arahnya dapat ditentukan sendiri oleh pengguna. Dalam menentukan sudut putar *ang* dapat dilihat pada gambar - gambar dibawah, sebagai berikut :

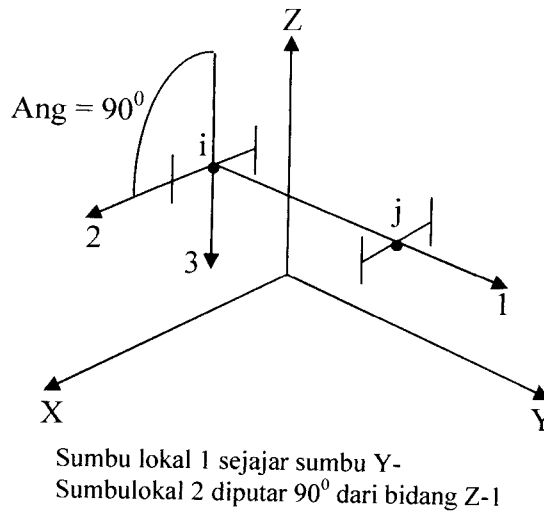

Gambar 3.1. Menentukan sudut putar *ang*

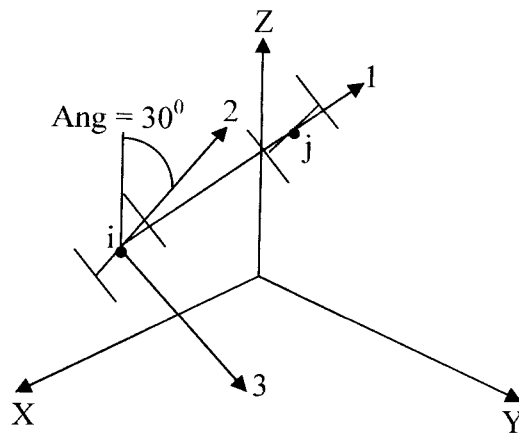

Gambar 3.2. Menentukan sudut putar *ang*

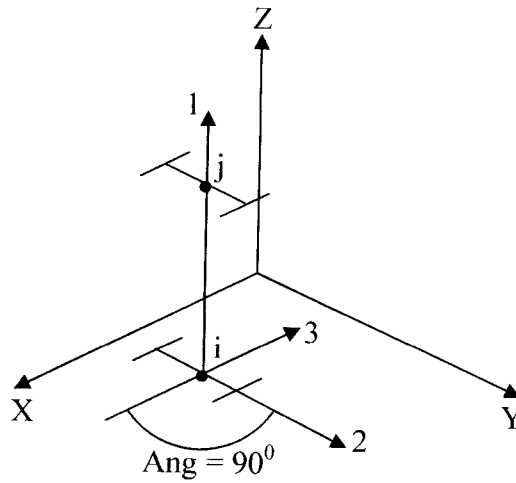

Sumbu lokal 1 sejajar sumbu Z-
 Sumbu lokal 2 diputar 90° dari bidang X-1

Gambar 3.3. Menentukan sudut putar *ang*

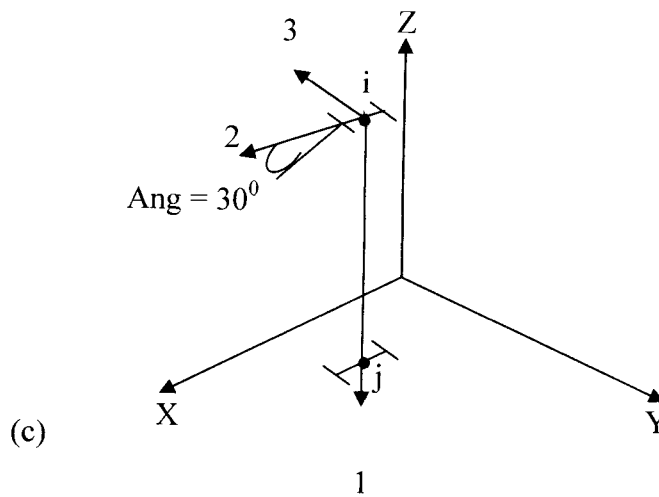

Sumbu lokal 1 sejajar sumbu Y-
 Sumbulokal 2 diputar 90° dari bidang \angle -1

Gambar 3.4. Menentukan sudut putar *ang*

Koordinat lokal 1-2-3 dan koordinat global **X-Y-Z** ini menggunakan aturan tangan kanan. Namun untuk koordinat lokal, arah sumbu lokalnya bebas ditentukan arahnya selama hal tersebut memudahkan dalam memasukan data dan menginterpretasikan hasilnya.

Untuk menentukan sistem koordinat lokal elemen yang umum, dapat menggunakan **orientasi default** dan **sudut koordinat elemen frame**, yang dapat dijelaskan sebagai berikut.

1. Sumbu lokal 1 arahnya selalu memanjang arah sumbu elemen, arah positif ialah dari ujung **i** keujung **j**.
2. Orientasi sumbu default sumbu lokal 2 dan 3 ditentukan oleh hubungan diantara sumbu lokal 1 dan sumbu global **Z** sebagai berikut :
 - Jika sumbu lokal 1 arahnya horisontal, maka bidang 1 – 2 dibuat sejajar dengan sumbu **Z**.
 - Jika sumbu lokal 1 arahnya keatas (**Z+**), maka arah sumbu lokal 2 sejajar dengan sumbu lokal **X+**.
 - Sumbu lokal 3 arahnya selalu horisontal searah bidang **X-Y**.Oleh program, elemen dianggap vertikal jika sinus sudut antara sumbu 1 dan sumbu **Z** kurang dari 10^{-3} .
3. Sudut koordinat *ang* digunakan untuk menentukan orientasi elemen yang berbeda dengan orientasi default. sudut ini memutar sumbu lokal 2 dan 3 terhadap sumbu 1 dari posisi orientasi default.

Rotasi positif ialah arah berlawanan jarum jam apabila sumbu 1 menuju ke arah pengamat.

Untuk elemen vertikal sudut *ang* ialah sudut antara sumbu lokal 2 dan sumbu X+ horisontal. Dengan kata lain *ang* ialah sudut antara sumbu lokal 2 dan bidang vertikal yang dilalui sumbu lokal 1.

3.3 Perencanaan Struktur Baja Dengan Metode LRFD

Perencanaan struktur baja dengan metode LRFD adalah perencanaan dengan mengkombinasikan tegangan ultimit dan *serviceability* dengan probabilitas berdasarkan pendekatan keamanan.

Perencanaan dengan metode LRFD ini sebenarnya sama dengan perencanaan metode plastis, yaitu dengan mempertimbangkan tegangan ultimit. Dalam metode ini, beban-beban yang terjadi dikalikan dengan suatu faktor (*overcapacity factor*) yang nilainya lebih dari 1 (*undercapacity factor*). Filosofi perencanaan dengan metode LRFD adalah sebagai berikut.

Gaya yang dapat digunakan $\geq \Sigma$ Gaya akibat beban terfaktor

3.3.1 Kombinasi Pembebanan Dalam LRFD

Menurut Tata Cara Perencanaan Struktur Baja Untuk Bangunan Gedung 2000, Kombinasi pembebanan dalam perencanaan struktur baja dengan metode LRFD adalah sebagai berikut.

$$1,4 D \dots\dots\dots (3.4)$$

$$1,2 D + 1,6 L + 0,5 (L_a \text{ atau } H) \dots\dots\dots (3.5)$$

$$1,2 D + 1,6 (L_a \text{ atau } H) + (\gamma_L L \text{ atau } 0,8W) \dots\dots\dots (3.6)$$

$$1,2 D + 1,3 W + \gamma_L L + 0,5 (La \text{ atau } H) \dots\dots\dots (3.7)$$

$$1,2 D + 1,0 E + \gamma_L L \dots\dots\dots (3.8)$$

$$0,9 D - (1,3W \text{ atau } 1,0E) \dots\dots\dots (3.9)$$

dengan : D = beban mati, L = beban hidup

La = beban hidup di atap selama perawatan atau selama penggunaan, H = beban hujan, W = beban angin, E = beban gempa, $\gamma_L = 0,5$ bila $L < 5\text{kN m}^2$, dan $\gamma_L = 1.0$ bila $L \geq 5\text{kN/m}^2$

3.3.2 Perencanaan Lentur Balok

Suatu balok yang menahan momen lentur harus memenuhi persamaan

$$M_u \leq \phi M_n \dots\dots\dots (3.10)$$

dengan : M_u = momen lentur terfaktor , ϕ = faktor reduksi yang nilainya 0,9, M_n = kuat lentur normal penampang

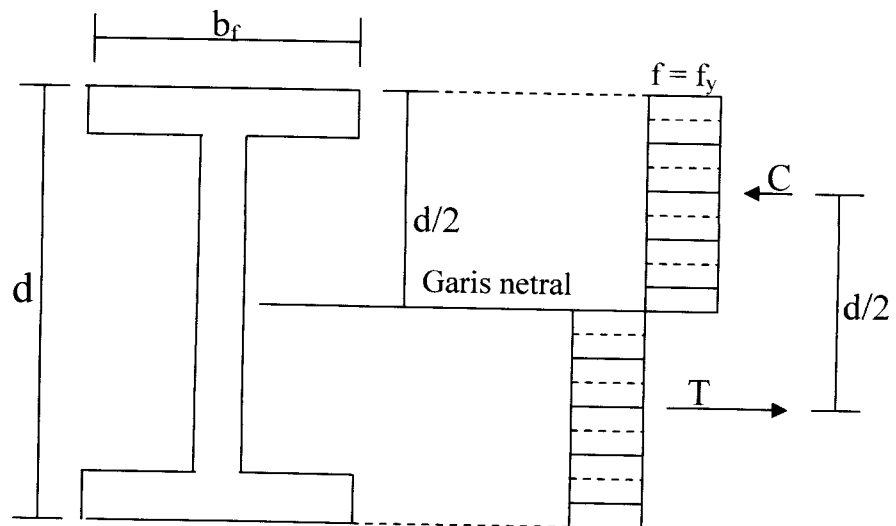

Gambar 3.5. Distribusi tegangan

Menurut AISCM-LRFD kuat lentur nominal penampang dihitung dengan rumus – rumus sebagai berikut:

a. Untuk penampang kompak

Kriteria penampang kompak adalah penampang yang memenuhi :

1. Rasio lebar sayap terhadap tebal sayap

$$\frac{b}{2.t_f} \leq \frac{171}{\sqrt{F_y(Mpa)}} \dots\dots\dots (3.11)$$

2. Rasio tinggi badan terhadap tebal memenuhi

$$\frac{d}{t_w} \leq \frac{1680}{\sqrt{f_y(Mpa)}} \dots\dots\dots (3.12)$$

dengan : b = lebar sayap, t_f = tebal sayap, d = tinggi penampang

t_w = tebal badan, f_y = tegangan leleh (Mpa)

Kuat lentur penampang kompak dipengaruhi oleh panjang bentang antara dua dukungan lateral (L)

Kasus 1 ($L \leq L_p$)

Kuat komponen struktur yang memenuhi $L \leq L_p$ kuat nominal komponen struktur terhadap lentur adalah

$$M_n = M_p = Z . f_y \dots\dots\dots (3.13)$$

dengan : $L_p = 1,76 . r_y . \sqrt{\frac{E}{f_y}}$, (Mpa), Z = modulus penampang

plastis

Kasus 2 ($L_p < L < L_r$)

Untuk komponen struktur yang memenuhi $L_p < L < L_r$. Kuat nominal komponen struktur terhadap momen lentur adalah

$$M_n = C_b \left\{ M_r + (M_p - M_r) \left[\frac{L_r - L}{L_r - L_p} \right] \right\} \leq M_p \dots\dots\dots (3.14)$$

dengan : $M_r = (f_y - f_r) \cdot S_x$

$$L_r = \frac{r_y \cdot X_1}{(f_y - f_r)} \sqrt{1 + \sqrt{1 + X_2 (f_y - f_r)^2}} \dots\dots\dots (3.15)$$

$$X_1 = \frac{\pi \sqrt{EGJA}}{S} \quad , J = \text{konstanta puntir torsi}$$

$$X_2 = \frac{I_w}{I_y} \left(\frac{S}{GJ} \right)^2 \cdot 4 \quad , I_w = \text{konstanta puntir lengkung}$$

Nilai X_1 dan X_2 bisa dilihat ditabel AISC-LRFD.

C_b = faktor pengali momen, yang besarnya dapat dihitung dengan

$$C_b = 1,75 + 1,05 \cdot \frac{M_1}{M_2} + 0,3 \cdot \left(\frac{M_1}{M_2} \right)^2 \leq 2,3 \dots\dots\dots (3.16)$$

dengan : $\left(\frac{M_1}{M_2} \right)$ adalah rasio momen-momen ujung, bertanda positif

jika M_1 dan M_2 membentuk lengkung ganda (*double curvature*), bertanda negatif bila membentuk lengkung tunggal (*single curvature*)

C_b sama dengan 1,0 untuk batang yang tidak ada tambahan lateralnya.

Kasus 3 ($L > L_r$)

Untuk komponen stuktur yang memenuhi $L > L_r$. kuat nominal komponen struktur terhadap lentur adalah

$$M_n = M_{cr} \leq M_p \dots\dots\dots (3.17)$$

$$\text{dengan : } M_{cr} = \frac{c_b \cdot S_x \cdot X_1 \cdot \sqrt{2}}{(L/r_x)} \sqrt{1 + \frac{X_1^2 \cdot X_2}{2 \cdot (L/r_y)^2}} \dots\dots\dots (3.18)$$

3.3.3 Perencanaan Kolom

Menurut AISCM LRFD komponen struktur yang mengalami momen lentur dan gaya aksial direncanakan menurut persamaan berikut ini.

o Pada portal 3D

$$\text{Untuk } \frac{P_u}{\phi P_n} \geq 0,2$$

$$\frac{P_u}{\phi P_n} + \frac{8}{9} \left(\frac{M_{ux}}{\phi_b M_{nx}} + \frac{M_{uy}}{\phi_b M_{ny}} \right) \leq 1,0 \dots\dots\dots (3.19)$$

$$\text{Untuk } \frac{P_u}{\phi P_n} < 0,2$$

$$\frac{P_u}{2 \cdot \phi P_n} + \left(\frac{M_{ux}}{\phi_b M_{nx}} + \frac{M_{uy}}{\phi_b M_{ny}} \right) \leq 1,0 \dots\dots\dots (3.20)$$

dengan : P_u = gaya aksial terfaktor, P_n = Kuat nominal penampang

ϕ = faktor reduksi kekuatan (untuk tekan nialainya 0,85)

M_u = momen lentur terfaktor terhadap sumbu-x dan sumbu-y

M_n = kuat nominal lentur penampang terhadap sb-x dan sb-y

○ **Pada portal 2D**

Untuk $\frac{P_u}{\phi P_n} \geq 0,2$

$$\frac{P_u}{\phi P_n} + \frac{8}{9} \left(\frac{M_u}{\phi_b \cdot M_n} \right) \leq 1,0 \dots\dots\dots (3.21)$$

Untuk $\frac{P_u}{\phi P_n} < 0,2$

$$\frac{P_u}{2 \cdot \phi P_n} + \left(\frac{M_u}{\phi_b \cdot M_n} \right) \leq 1,0 \dots\dots\dots (3.22)$$

Perbandingan kekakuan pada rangka portal

$$G = \frac{\sum \left(\frac{I_c}{L_c} \right)}{\sum \left(\frac{I_g}{L_g} \right)} \dots\dots\dots (3.23)$$

dengan : G = Perbandingan total kekakuan kolom dalam suatu join terhadap kekakuan balok dalam suatu join yang sama,

I_c = Momen inersia kolom, L_c = Panjang kolom, I_g = Momen inersia balok, L_g = Panjang balok

$$\text{Rasio kerampingan} = \frac{K_l}{r} \dots\dots\dots (3.24)$$

diambil yang terbesar antara : $\frac{K_l}{r_x}$ dan $\frac{K_l}{r_y}$

dengan K_l = Panjang efektif kolom

Kuat nominal penampang

$$\phi P_n = \phi F_{cr} \cdot A_g \dots\dots\dots (3.25)$$

dengan : F_{cr} = Tegangan kritis, A_g = Luas bruto

Dalam perencanaan baja tahan gempa maka harus direncanakan dengan konsep “*Strong column weak beam*”. Untuk mendapatkan tujuan tersebut maka digunakan rumus berikut ini.

Gaya aksial kolom rencana (P_u) untuk kolom eksterior.

$$P_u = 1,2 P_D + P_L + P_E \dots\dots\dots (3.24)$$

Gaya aksial kolom rencana (P_u) untuk kolom interior

$$P_u = 1,2.P_D + P_L \dots\dots\dots (3.25)$$

Momen rencana kolom (M_u) untuk kolom eksterior

$$M_u = M_{pb} \cdot \left(\frac{L}{L_b} \right) \cdot \left(\frac{h_c}{2h} \right) \dots\dots\dots (3.26)$$

Momen rencana kolom (M_u) untuk kolom interior

$$M_u = 2.M_{pb} \cdot \left(\frac{L}{L_b} \right) \cdot \left(\frac{h_c}{2.h} \right) \dots\dots\dots (3.27)$$

dengan : P_D = gaya aksial akibat beban mati, P_L = gaya aksial akibat beban hidup, P_E = gaya aksial akibat beban gempa,
 M_{pb} = momen plastik balok = $Z.f_y$, L_b = panjang tanpa penopang lateral, L = bentang balok dari as ke as, h = tinggi kolom dari as ke as

3.3.4 Perencanaan Sambungan Balok dengan Kolom

a. Sambungan menahan tarik/desak

Momen plastis yang terjadi pada balok akan didistribusikan menjadi tegangan/gaya tarik dan tekan pada sayap balok sebesar :

$$T_u = \frac{M_f}{0,95.d} \dots\dots\dots (3.40)$$

dengan : T_u = kuat tarik/tekan terfaktor (KN), M_f = momen plastis yang terjadi pada muka kolom (KN.m), d = tinggi keseluruhan profil (mm).

Pada umumnya elemen tarik dapat mengalami retak akibat pelelehan pada penampang bruto, maupun retakan pada penampang bersihnya. Sehingga tebal plat sambung (*flange plate*) didesain berdasarkan nilai terkecil dari dua kondisi :

1) Kondisi pelelehan tarik pada penampang bruto (A_g) :

$$T_u \leq \phi.T_n \dots\dots\dots (3.41)$$

$$\phi.T_n = \phi.F_y . A_g \dots\dots\dots (3.42)$$

dengan : T_u = gaya tarik/tekan terfaktor (KN), $\phi.T_n$ = gaya tarik/tekan nominal (KN), dengan ϕ adalah faktor reduksi tarik/tekan (0,9), A_g = luas penampang bruto *flange plate* (mm²).

2) Kondisi fraktur/retakan pada penampang bersih (A_e) :

$$\phi.T_n = \phi.F_u . A_e \dots\dots\dots (3.43)$$

dengan : ϕ = faktor reduksi untuk retakan (0,75), A_e = luas penampang bersih profil (mm^2) $A_e = U.A_n$, U adalah koefisien reduksi sama dengan 1 untuk elemen penghubung, A_n = luas tampang *netto* (mm^2).

Perhitungan selanjutnya yaitu menentukan jumlah baut yang diperlukan untuk mentransfer gaya tarik dan tekan pada bagian atas dan bawah balok :

Menentukan kuat geser satu baut

$$\phi.R_n = \phi \cdot (0,6.F_u^b) \cdot m \cdot A_b \dots\dots\dots (3.44)$$

Kebutuhan baut minimal untuk menahan geser

$$n_{\min} = \frac{T_u}{\phi.R_n} \dots\dots\dots (3.45)$$

dengan : $\phi.R_n$ = kuat geser baut (KN), T_u = gaya tarik/tekan terfaktor (KN), F_u^b = tegangan tarik material baut (KN), m = banyaknya bidang geser, A_b = luas penampang lintang bruto dari satu baut (mm^2).

Untuk menghindari kegagalan tumpu pada masing-masing elemen yang disambung, maka kuat tumpu elemen yang paling kritis (sayap balok/*flange plate*) harus lebih besar dari tegangan yang terjadi, yaitu sebesar :

$$\phi.R_n = \phi \cdot 2,4 \cdot F_u \cdot d_b \cdot t \geq \phi.R_n \dots\dots\dots (3.46)$$

dengan : $\phi = 0,75$, db = diameter baut (mm), t = tebal bagian yang paling kritis menahan beban (mm)

Perhitungan selanjutnya yaitu mengontrol blok geser pada sayap balok.

Tegangan tarik dan tekan (T_n) merupakan nilai terbesar dari :

1. Pelelehan geser – peretakan tarik

$$T_n = 0,6 \cdot F_y \cdot A_{vg} + F_u \cdot A_{nt} \dots\dots\dots (3.47)$$

2. Peretakan geser – pelelehan tarik

$$T_n = 0,6 \cdot F_u \cdot A_{ns} + F_y \cdot A_{tg} \dots\dots\dots (3.48)$$

dengan : A_{vg} = luas bruto yang mengalami pelelehan geser (mm^2), A_{tg} = luas bruto yang mengalami pelelehan tarik (mm^2), A_{ns} = luas netto yang mengalami retakan geser (mm^2), A_{nt} = luas netto yang mengalami retakan geser (mm^2).

Cek blok geser pada bagian yang paling kritis dalam menahan

beban : $\phi \cdot T_n \geq T_u \quad (\phi = 0,75) \dots\dots\dots (3.49)$

b. Sambungan yang menahan geser

Transfer gaya geser dari balok ke kolom, merupakan nilai terkecil dari :

$$V_f = \frac{2 \cdot M_f}{L_n} + V_g \dots\dots\dots (3.50)$$

$$V_f = 1,05 \left(V_D + V_L + \frac{4}{K} \cdot V_E \right) \dots\dots\dots (3.51)$$

$$\text{Jumlah baut } n = \frac{V_f}{\phi \cdot R_n} \dots\dots\dots (3.52)$$

Menentukan tebal plat geser yang dibutuhkan untuk meletakkan baut pada plat dengan cara coba-coba, dimana plat geser harus kuat terhadap geser leleh pada plat :

$$\phi \cdot R_n = \phi \cdot (0,6 \cdot F_y) \cdot A_g \geq V_f \dots\dots\dots (3.53)$$

dengan : $\phi = 0,9$, F_y = tegangan leleh profil baja (Mpa), A_g = luas tampang bruto pada plat geser (mm^2)

Geser fraktur pada plat :

$$\phi \cdot R_n = \phi \cdot (0,6 \cdot F_u) \cdot A_n \geq V_f \dots\dots\dots (3.54)$$

dengan : $\phi = 0,75$, F_u = tegangan tarik baja struktur (KN), A_n = luas tampang netto pada plat geser (mm^2)

Kemudian perhitungan selanjutnya yaitu mengontrol blok geser yang terjadi pada sayap balok, dapat digunakan rumus sesuai dengan persamaan 3.47 sampai dengan 3.49.

Menentukan panjang las fillet pada plat geser, pertama harus menentukan kekuatan las sambung antara plat geser ke sayap kolom ditentukan dengan resistensi geser melalui leher las sebesar

$$\phi R_{nw} = \phi \cdot (0,6 \cdot F_{Exx}) \cdot t_c \dots\dots\dots (3.55)$$

Tapi tidak perlu lebih besar dari kekuatan fraktur geser dari logam dasar sebesar

$$\phi R_{nw} = \phi \cdot (0,6 \cdot F_u) \cdot t_{pl} \dots\dots\dots (3.56)$$

dengan : F_{Exx} = kekuatan tarik elektroda las (KN), t_c = dimensi leher efektif, t_{pl} = tebal material dasar sepanjang las (mm)

Panjang las yang dibutuhkan

$$P_{las} = \frac{Vf}{\phi \cdot R_{nw}} \dots\dots\dots (3.57)$$

dengan : Vf = gaya geser dari balok ke kolom (KN), ϕR_{nw} = kekuatan las terhadap geser/fraktur (KN.m)

3.3.5 Perencanaan Sambungan Kolom dengan Kolom

Sambungan kolom dilakukan karena adanya keterbatasan panjang profil yang tersedia dan perbedaan profil yang dipakai. Dalam perencanaannya sambungan dibagi menjadi dua, yaitu sambungan badan dan sambungan sayap.

Sambungan sayap merupakan sambungan yang berada pada sayap kolom. Sambungan ini dibagi menjadi dua, yaitu sambungan pelat sayap dalam dan sambungan pelat sayap luar. Perencanaan awal yaitu menentukan besarnya gaya yang terjadi pada kedua sayap kolom akibat momen rencana kolom sebagai berikut :

$$P_{u_f} = \frac{M_{u,k}}{0,95 \cdot d} \dots\dots\dots (3.58)$$

dengan : P_{u_f} = gaya pada tiap sayap kolom (KN), $M_{u,k}$ adalah momen rencana kolom didapat dari analisis struktur (KN.m), d = lebar/tinggi profil kolom keseluruhan (mm).

a. Sambungan pada sayap

Menentukan kuat geser satu baut sesuai dengan persamaan 3.44, selanjutnya menghitung jumlah baut minimum yang diperlukan pada sambungan diperoleh melalui persamaan 3.58 sebagai berikut :

$$n \text{ perlu} = \frac{P_{uf}}{2 \cdot \phi \cdot Rn} \dots\dots\dots (3.59)$$

Kontrol kekuatan sayap kolom

Untuk $\phi \cdot Rn > P_{uf} \dots\dots\dots (3.60)$

Fu. Ant > 0,60. fu. Ans, maka

$$\phi \cdot Rn = \phi (fu \cdot Ant + 0,6 \cdot fy \cdot Ags) \dots\dots\dots (3.61)$$

Desain plat sambung pada sayap

Setelah jumlah baut diketahui, maka langkah selanjutnya adalah mendesain pelat sambung. Lebar pelat sambung ditentukan dengan cara coba-coba, setelah itu menentukan luas penampang *bruto flange plate* (mm²).

$$Ag = \frac{Pu_f}{0,9 \cdot Fy(Mpa)} \dots\dots\dots (3.62)$$

Kemudian mengontrol kekuatan pelat sambung, sesuai dengan persamaan 3.63 dibawah ini.

$$\phi \cdot Rn = \phi \cdot fu \cdot Ant > \frac{Pu_f}{2} \dots\dots\dots (3.63)$$

dengan : $\phi = 0,75$, F_u = tegangan tarik baja struktur (Mpa), A_{nt} = luas tampang netto pada plat geser (mm^2)

Kemudian dikontrol blok geser plat sambung menggunakan persamaan 3.64 dibawah ini.

$F_u.A_{nt} < 0,60.f_u.A_{ns}$, maka

$$\phi.R_n = \phi(0,6.f_u.A_{ns} + f_y.A_{gt}) > \frac{P_u}{2} \dots\dots\dots (3.64)$$

dengan : $\phi = 0,75$, F_u = tegangan tarik baja struktur (KN), A_{nt} = luas netto yang mengalami retakan geser (mm^2), A_{ns} = luas netto yang mengalami retakan geser (mm^2), A_{gt} = luas tampang bruto pada plat geser (mm^2), P_u = gaya pada tiap sayap kolom (KN), $\phi.R_n$ = kuat tumpu satu baut (KN).

Kemudian kontrol kuat tumpu plat sambung kolom dengan persamaan (3.65) dibawah ini.

$$\phi.R_n = \phi. 2,4. F_u. D_b. t_p > \frac{P_u}{2} \dots\dots\dots (3.65)$$

dengan : F_u = tegangan ultimit baja (KN), d_b diameter baut (mm), t_p = tebal sayap kolom (mm), A_{nt} = luas netto pelat sambung (mm^2), $\phi = 0,75$.

b. Sambungan pada badan

Sambungan badan merupakan sambungan yang berada pada badan kolom, gaya pada badan kolom diperoleh melalui persamaan 3.66 dibawah ini

$$P_{uw} = \frac{P_{u,k} \cdot A_g}{A} \dots\dots\dots (3.66)$$

Desain plat sambung pada badan kolom

Desain pelat sambung kolom pada badan dapat menggunakan persamaan 3. 62 sampai dengan 3.65 dapat dipakai.

3.3.6 Perencanaan Pelat Dasar Kolom

Pelat dasar kolom merupakan penghubung antara kolom baja dengan kaki kolom beton (Pedestal). Dalam perencanaannya pelat dasar kolom akan didesain berdasarkan beban aksial dan momen yang terjadi didasar kolom. Desain plat dasar kolom dipengaruhi oleh momen arah x ($M_{u,kx}$) dan arah y ($M_{u,ky}$).

Kesetimbangan momen pada pusat gaya aksial T :

$$P_{u,k} \left(\frac{dc}{2} + \frac{bf_{ca}}{2} \right) + M_{u,k_x} + M_{u,k_y} = R \left(dc + bf_{ca} - \frac{tf}{2} \right) \dots(3.77)$$

Diasumsikan luas bidang tekan efektif penumpu akibat momen yang bekerja adalah (X.B), sehingga gaya tekan yang terjadi harus memenuhi :

$$\phi P_p \geq P_u \dots\dots\dots (3.78)$$

$$\phi(0,5 \cdot F_p \cdot X.B) = P_u$$

$$F_p = 0,85 \cdot F_y < \text{Tegangan desak beton (fy dalam Mpa)}$$

$$\text{Jarak dari pusat flens ke ujung pelat} = 1/3 \cdot X \dots\dots\dots (3.79)$$

Panjang pelat dasar yang dibutuhkan

$$L = (2.X) + (dc - tf) \dots\dots\dots (3.80)$$

dengan : X = panjang bidang tekan (mm), dc adalah tinggi keseluruhan profil baja (mm), tf = tebal sayap dari profil baja (mm).

Menentukan jarak tepi pelat dasar kolom dengan profil baja pada arah lebar dan panjang

$$m = \frac{L - 0,95.dc}{2} \dots\dots\dots (3.81)$$

$$n = \frac{B - 0,8.bf}{2} \dots\dots\dots (3.82)$$

Tegangan pada ujung pelat :

$$f_p = \frac{Pu}{B.L} \pm \frac{Mu, kx}{\frac{1}{6}B.L} \pm \frac{Mu, ky}{\frac{1}{6}B.L} < F_p \text{ (fy dalam Mpa) } \dots\dots (3.83)$$

Cek kapasitas penumpu (pedestal)

$$\phi P_p \geq P_u \dots\dots\dots (3.84)$$

$$\phi P_p = \phi_c \cdot F_p \cdot A \dots\dots\dots (3.85)$$

Momen lentur pelat titik A, sepanjang B (tegak lurus gambar)

$$M_u = 0,5 \cdot (f_{p_{\max}} - y) \cdot \frac{x}{3} \cdot \left(\frac{2}{3} \cdot \frac{x}{3} \right) B + y \cdot \frac{x}{3} \cdot \left(\frac{1}{2} \cdot \frac{x}{3} \right) B \dots\dots (3.86)$$

Batas pelelehan untuk lentur pada pelat menghendaki

$$\phi M_n \geq M_u \dots\dots\dots (3.89)$$

$$\phi M_n = \phi M_p = \phi_b \cdot Z \cdot f_y = 0,9 \left(\frac{B \cdot t_p^2}{4} \right) \cdot f_y \geq M_u \dots\dots\dots (3.90)$$

Tebal pelat yang diperlukan

$$t_p = \sqrt{\frac{4.Mu}{0,9.B.fy}} \dots\dots\dots (3.91)$$

Perencanaan baut angkur arah y yang menahan Mu,kx

$$T = \frac{Mu,kx}{d} \dots\dots\dots (3.92)$$

Kapasitas tarik satu angkur (ϕT_n)

$$\phi T_n = \phi.0,75.f_u.A_b \dots\dots\dots (3.93)$$

Jumlah angkur minimum yang diperlukan

$$n = \frac{T}{\phi T_n} \dots\dots\dots (3.94)$$

Kedalaman angkur :

Gaya tarik yang ditahan satu angkur

$$T_n = \frac{T}{n} \dots\dots\dots (3.95)$$

Tegangan ijin tarik beton :

$$f_t' = 0,57 \sqrt{f_c'} (Mpa) \dots\dots\dots (3.96)$$

gaya tarik = luas permukaan angkur \times tegangan ijin tarik beton

$$T_n = \pi.D.L.f_t' \dots\dots\dots (3.97)$$

Kedalaman angkur yang diperlukan

$$H = \frac{T_n}{\pi.D.f_t'} \dots\dots\dots (3.98)$$

dengan : T_n = gaya tarik yang terjadi pada angkur (KN), D = diameter angkur (mm), f_t' = tegangan ijin tarik beton (Mpa).

Perencanaan angkur arah y yang menahan M_u,ky sama dengan perencanaan angkur arah x, sehingga persamaan (3.94) sampai dengan (3.98) dapat dipakai.

3.3.7 Perencanaan Pedestal (kaki kolom)

Pedestal (kaki kolom) merupakan elemen struktur yang berfungsi sebagai tempat perletakan pelat dasar kolom, terbuat dari beton. Dalam desainnya pedestal dirancang mempunyai dimensi yang lebih besar dari pelat dasar kolom dan tinggi pedestal harus lebih dari kedalaman angkur.

Tulangan longitudinal/lentur pedestal

Rasio tulangan pakai, $\rho = 1\%$

$$A_{st} = 0,01.A_g \dots\dots\dots (3.99)$$

Menentukan jumlah tulangan longitudinal

$$n = \frac{A_{st}}{A_{\phi 22}} \dots\dots\dots (3.100)$$

Tulangan sengkang

$$V_s = \frac{V_u, k_{pakai}}{\phi} \dots\dots\dots (3.101)$$

Jarak antar tulangan

$$S = \frac{A_v.f_y.d}{V_s} \dots\dots\dots (3.102)$$

BAB IV

METODE PENELITIAN

4.1 Data Struktur

Struktur stadion Sleman terletak diatas tanah lunak pada wilayah gempa tiga (3), Gambar denah struktur tribun stadion sleman dapat dilihat pada gambar 4.1 dibawah ini :

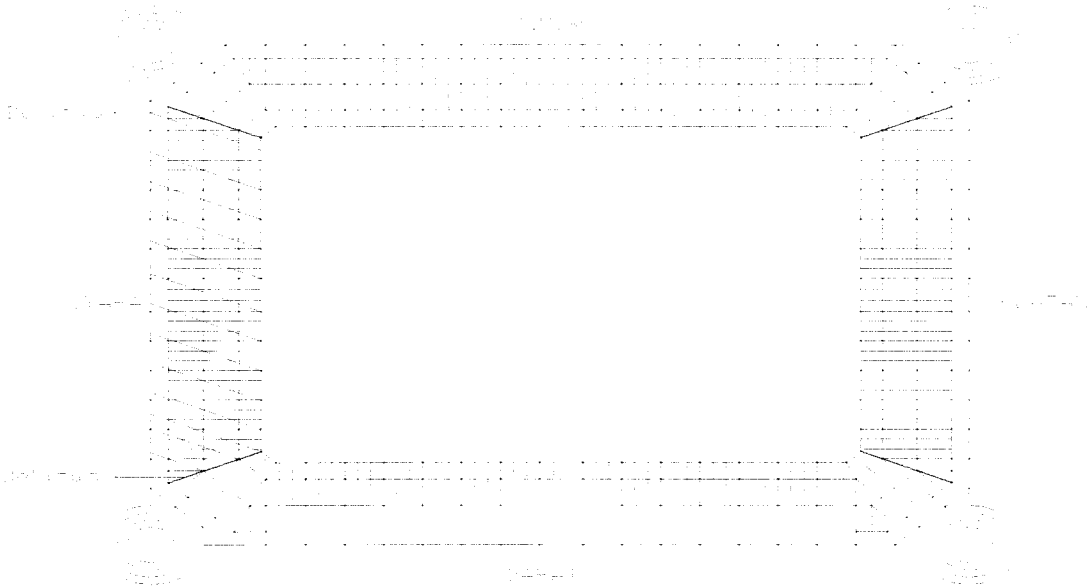

Gambar 4.1 Gambar Denah Struktur Tribun Bangunan

Daerah yang diarsir pada gambar 4.1 diatas menunjukkan bagian struktur stadion Sleman yang ditinjau yaitu struktur stadion blok utara. Agar lebih

jelasnya, gambar struktur stadion Sleman blok utara ini dapat dilihat pada gambar 4.2 dibawah ini



Gambar 4.2 Gambar Denah Struktur Tribun Blok Utara

Struktur portal tribun ini merupakan bangunan yang simetris, sehingga dapat ditinjau setengah bagian saja. Lebih jelasnya dapat dilihat pada gambar dibawah.

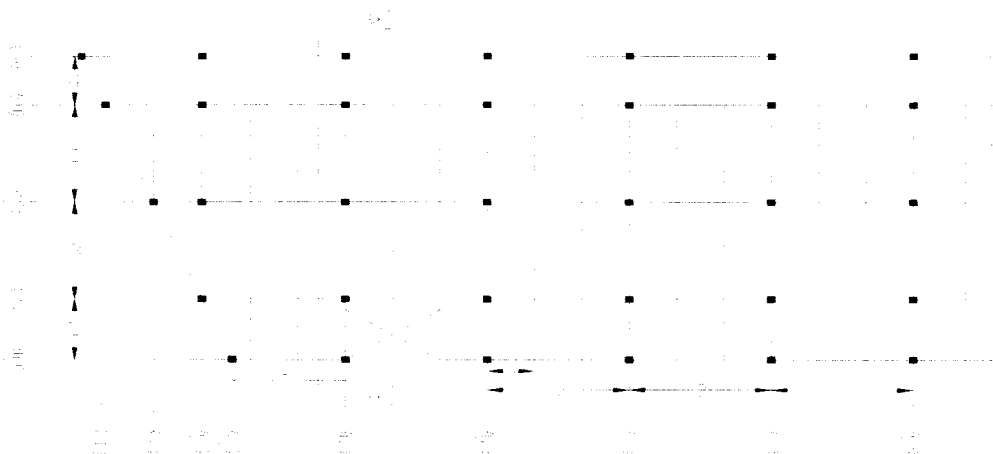

Gambar 4.3 Denah Struktur Tribun Blok Utara Setengah Bentang Bangunan

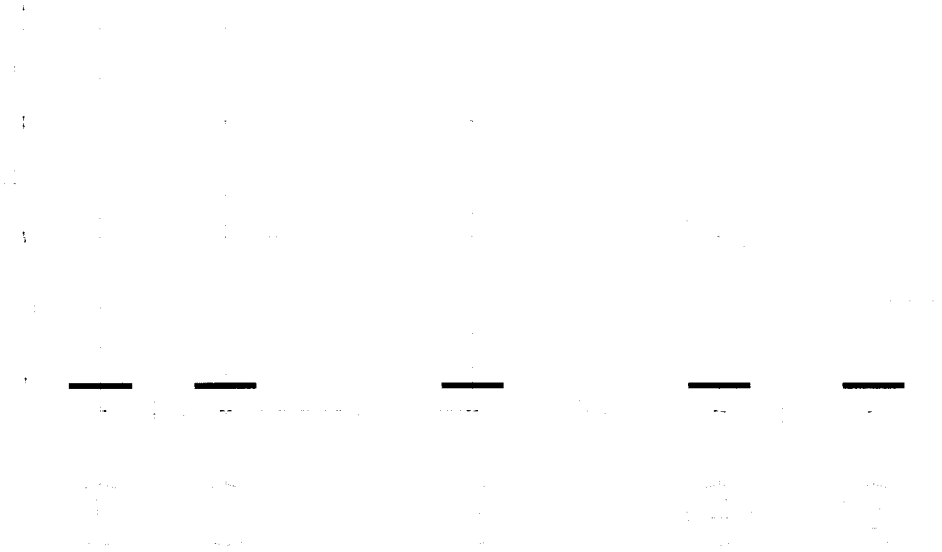

Gambar 4.4 Gambar Potongan I -I

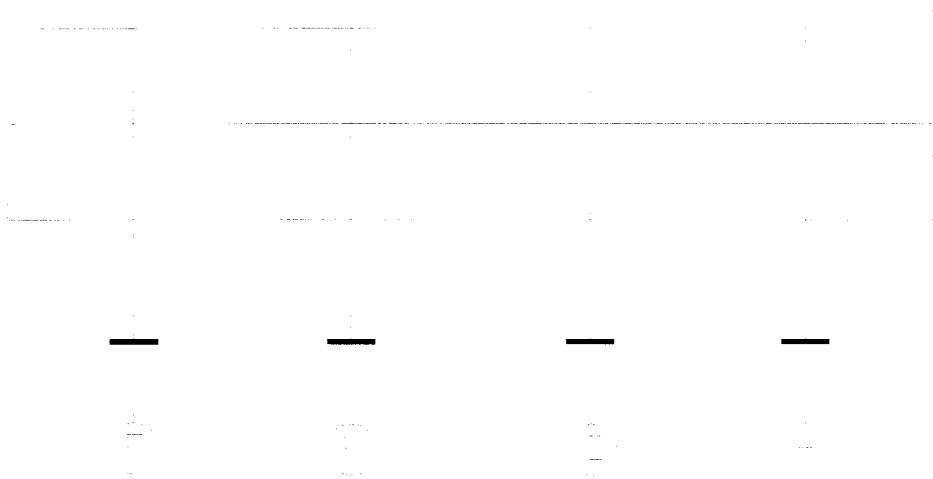

Gambar 4.5 Gambar Memanjang Portal 1

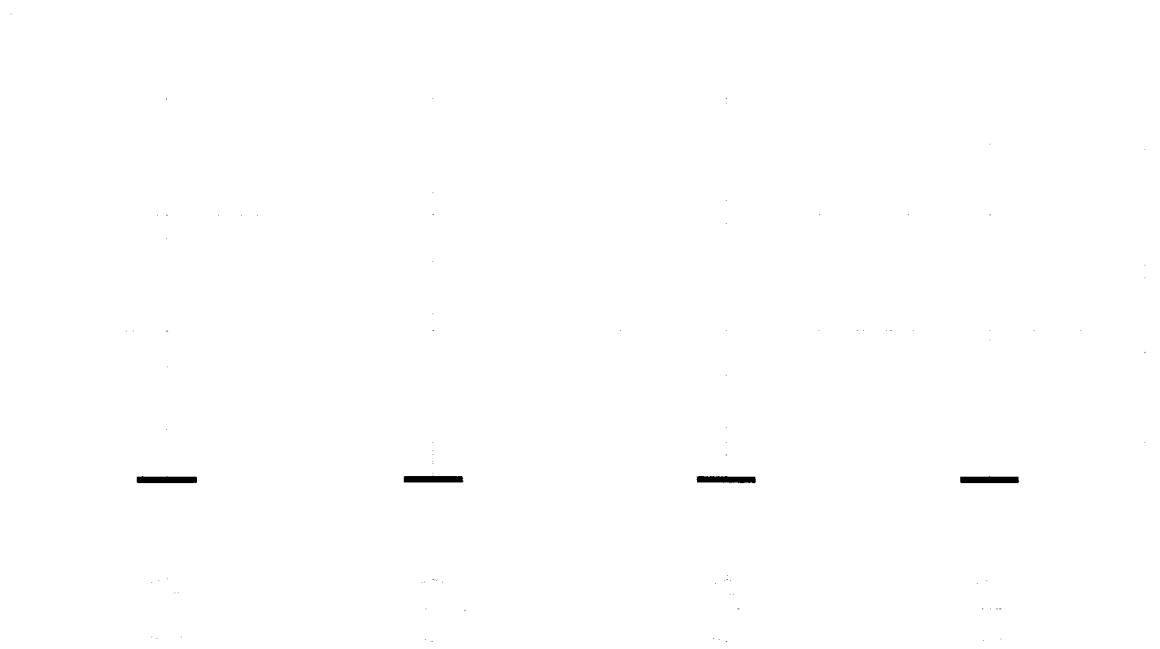

Gambar 4.6 Gambar Memanjang Portal 2

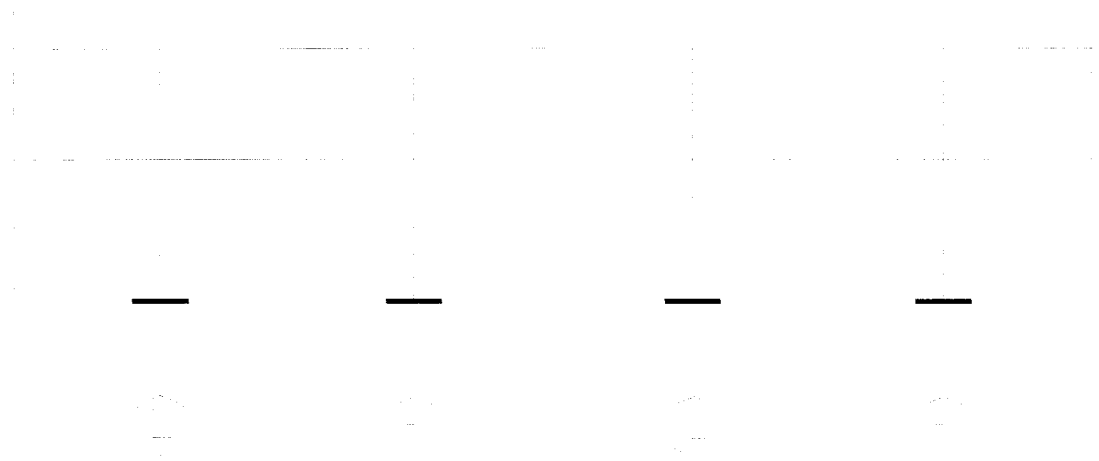

Gambar 4.7 Gambar Memanjang Portal 3

4.3 Tahapan analisis

Tahapan analisis dalam penulisan tugas akhir ini dapat dilihat pada gambar 4.7 yaitu gambar *flow chart* pengolahan.

Nilai ratio tegangan ijin dan tegangan yang terjadi tidak boleh kurang dari 1

dan maksimal 1,25 atau dapat ditulis $1,0 < \frac{\sigma_{ijin}}{\sigma_{terjadi}} \leq 1,25$.

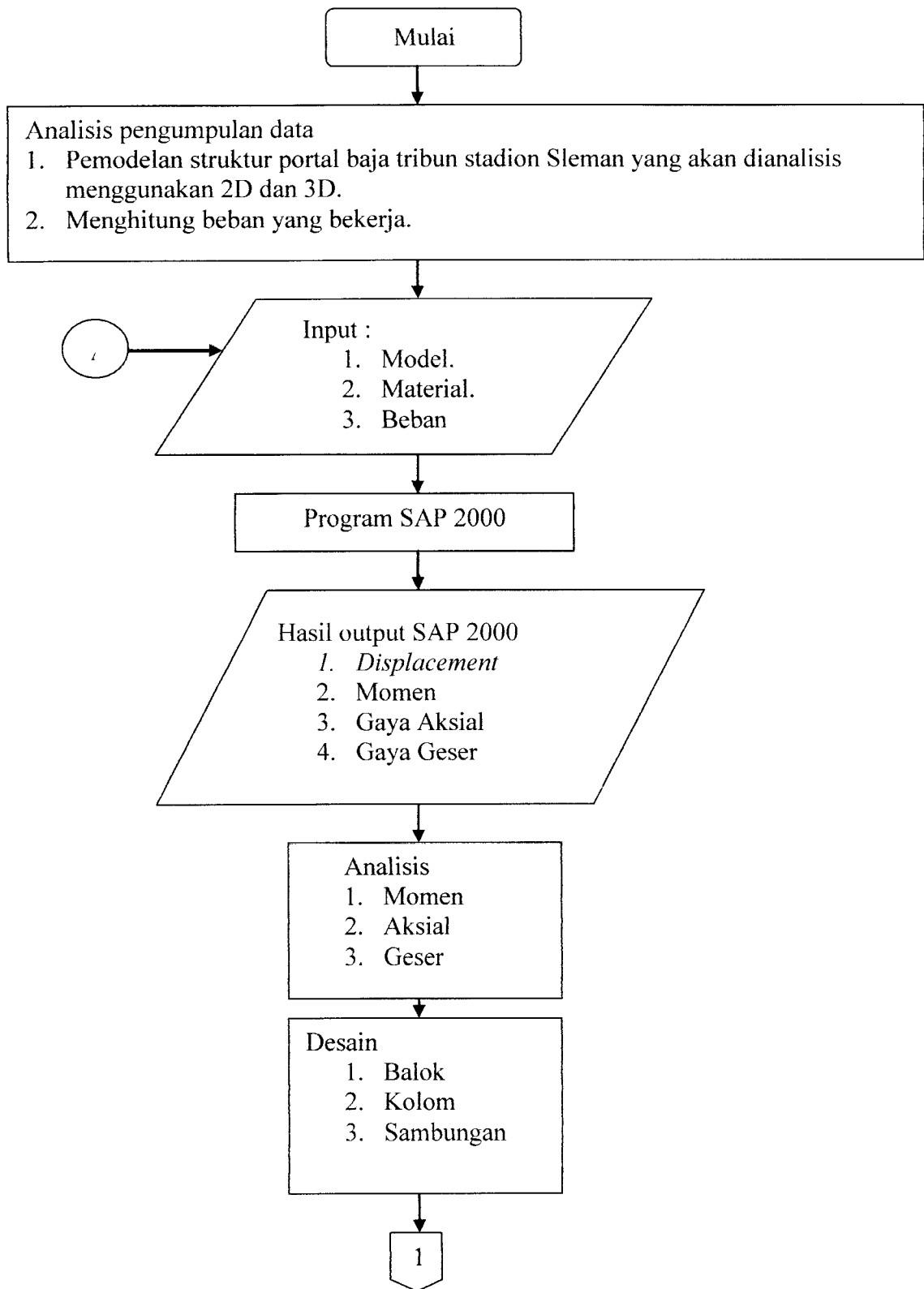

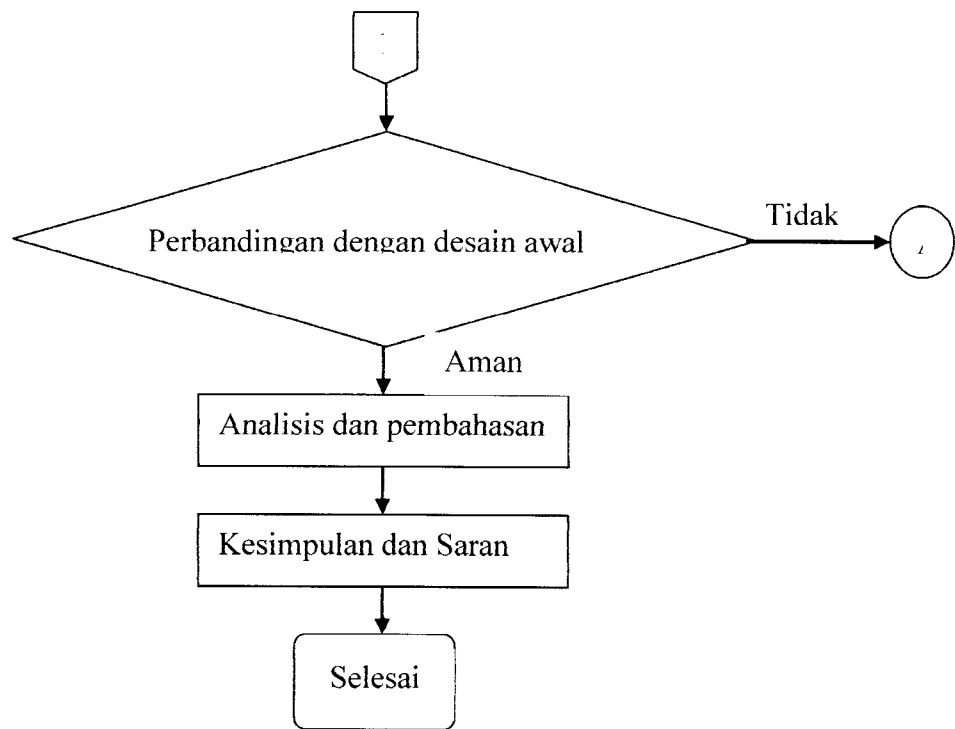

Gambar 4.7 Flow Chart Tahapan Analisis

Flow Chart Pengolahan analisis data memakai SAP 2000 dapat dilihat pada gambar 4.8.

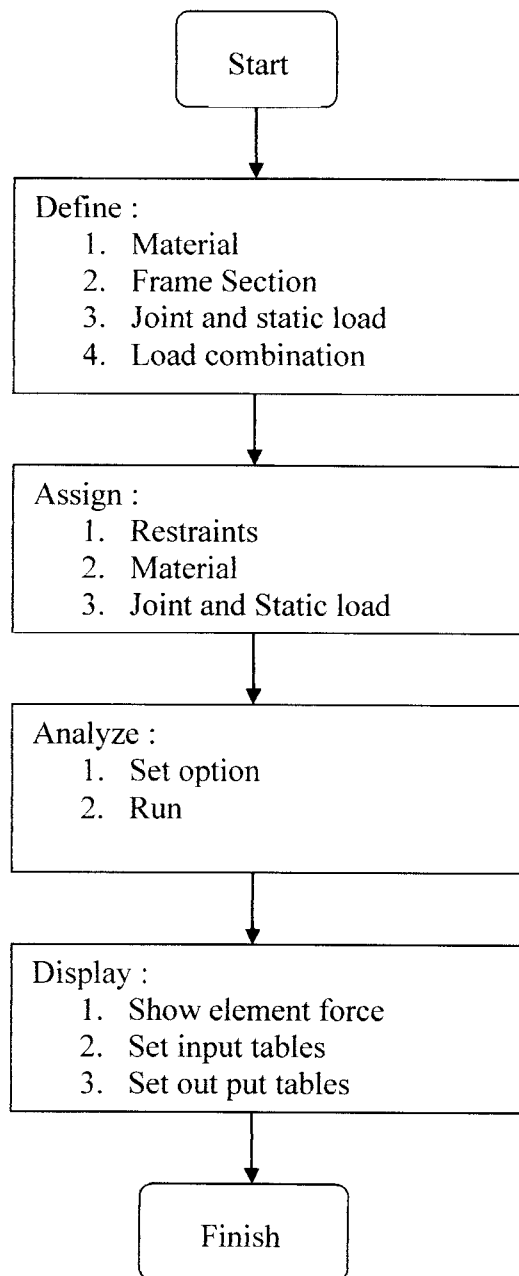

Gambar 4.8 *Flow Chart Analisis SAP 2000*

BAB V

ANALISIS DAN DESAIN STRUKTUR

5.1 Perencanaan Awal (Preliminari Design)

Perencanaan awal (preliminary design) merupakan perkiraan penampang balok dan kolom yang ditentukan oleh panjang bentang antara dua dukungan. Gambar denah pola balok lantai (elevasi lantai +2.500) ditunjukkan gambar 5.1 dibawah ini.

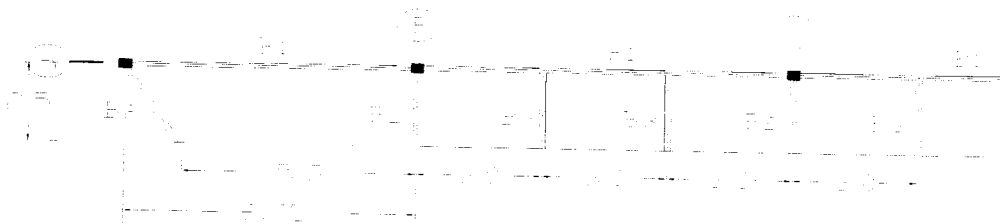

Gambar 5.1 Denah Pola Balok (Elevasi Lantai +2.500)

- Perkiraan penampang balok B₁ (Cantilever)

$$d = \frac{1}{12} \times L = \frac{1}{12} \times 9 = 0,75 \text{ m} = 750 \text{ mm}$$

Pakai W30 × 99 (d = 753,11 mm ; bf = 265,43 mm)

Berat = 1,444 KN/m

- Perkiraan penampang balok B₂ (Cantilever)

Pakai W21 × 57 (d = 534,924 mm ; bf = 166,497 mm)



Berat = 0,832 KN/m

- Perkiraan penampang balok B₃ (Cantilever)

W 18 × 55 (d = 459,99 mm ; bf = 191,262 mm)

Berat = 0,803 KN/m

Gambar denah pola balok lantai (elevasi lantai +5.000) ditunjukkan gambar 5.2 dibawah ini.

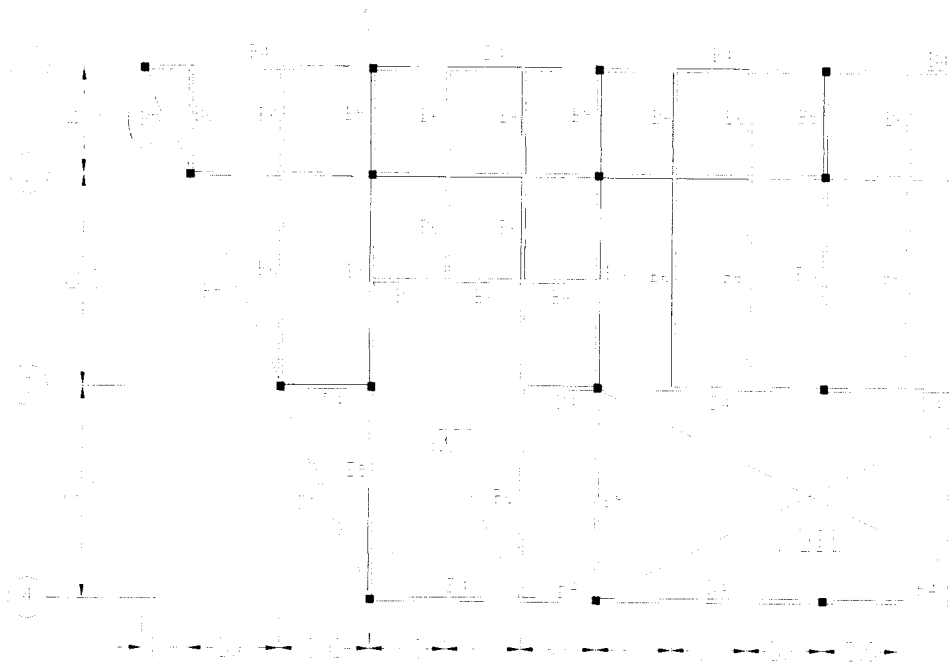

Gambar 5.2 Denah Pola Balok (Elevasi Lantai +5.000)

- Perkiraan penampang balok B₄

$$d = \frac{1}{12} \times L = \frac{1}{12} \times 9 = 0,75 \text{ m} = 750 \text{ mm}$$

Pakai W30 × 99 (d = 753,11 mm ; bf = 265,43 mm)

Berat = 1,444 KN/m

- o Perkiraan penampang balok B₅

$$d = \frac{1}{12} \times L = \frac{1}{12} \times 8 = 0,667 \text{ m} = 667 \text{ mm}$$

Pakai W27 × 84 (d = 678,434 mm ; bf = 252,984 mm)

Berat = 1,226 KN/m

- o Perkiraan penampang balok B₆

$$d = \frac{1}{15} \times L = \frac{1}{15} \times 8 = 0,533 \text{ m} = 533 \text{ mm}$$

Pakai W21 × 57 (d = 534,924 mm ; bf = 166,497 mm)

Berat = 0,832 KN/m

Perkiraan dimensi balok miring

Gambar pola balok miring ditunjukkan gambar 5.3 dibawah ini.

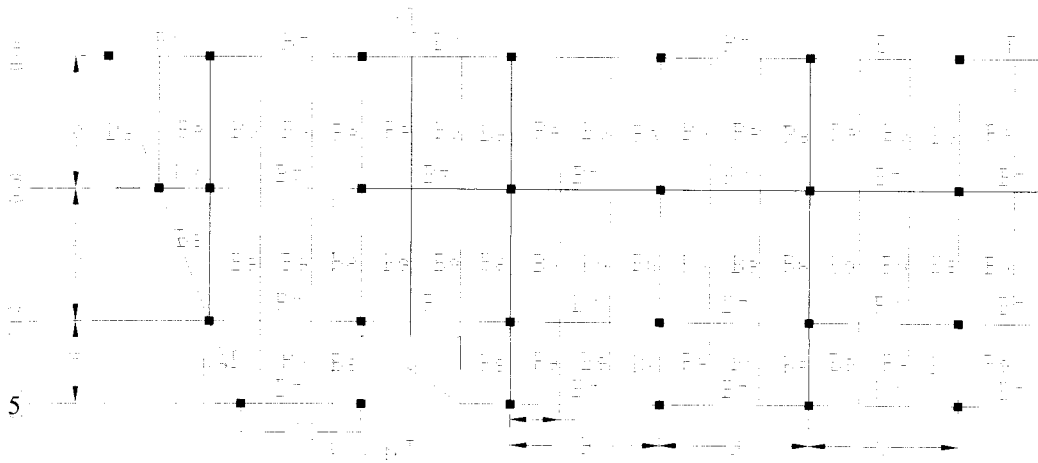

Gambar 5.3 Denah Pola Balok miring

- Perkiraan penampang balok B₇

$$d = \frac{1}{12} \times L = \frac{1}{12} \times 9 = 0,75 \text{ m} = 750 \text{ mm}$$

Pakai W30 × 99 (d = 753,11 mm ; bf = 265,43 mm)

Berat = 1,444 KN/m

- Perkiraan penampang balok B₈

$$\text{Panjang balok miring (L)} = \frac{8}{\text{Cos}.27^0} = 8,98 \text{ m}$$

$$d = \frac{1}{12} \times L = \frac{1}{12} \times 8,98 = 0,748 \text{ m} = 748 \text{ mm}$$

Pakai W30 × 99 (d = 753,11 mm ; bf = 265,43 mm)

Berat = 1,444 KN/m

- Perkiraan penampang balok B₉

$$d = \frac{1}{15} \times L = \frac{1}{15} \times 8,98 = 0,599 \text{ m} = 599 \text{ mm}$$

Pakai W24 × 55 (d = 598,678 mm ; bf = 177,927 mm)

Berat = 0,803 KN/m

Perkiraan dimensi kolom W 18 × 76 (d = 462 mm ; bf = 280,289 mm)

Berat = 1,131 KN/m

5.2 Pembebanan

Pembebanan merupakan langkah paling awal dalam mengerjakan hitungan struktur. Beban-beban yang dihitung, kemudian ditransfer ke balok portal sehingga mendapatkan gaya-gaya dalam yang dipergunakan untuk

menghitung dimensi profil struktur. Beban-beban yang bekerja dibagi menjadi tiga kelompok, yaitu beban mati, beban hidup dan beban gempa. Untuk selanjutnya beban mati dan beban hidup disebut dengan beban gravitasi.

5.2.1 Beban Gravitasi

Beban gravitasi merupakan beban yang terdiri dari beban mati dan beban hidup. Perhitungan berat pelat lantai dan pelat tribun pada struktur stadion sleman ini adalah sebagai berikut :

Berat pelat lantai

$$\text{Pelat} = 0,12 \times 24 = 2,88 \text{ KN/m}^2$$

$$\text{Pasir} = 0,05 \times 16 = 0,8 \text{ KN/m}^2$$

$$\text{Spesi} = 0,03 \times 24 = 0,72 \text{ KN/m}^2$$

$$\text{Keramik} = 0,01 \times 24 = 0,24 \text{ KN/m}^2$$

$$\mathbf{W_D = 4,64 \text{ KN/m}^2}$$

$$\text{Beban hidup pelat lantai (W}_L\text{)} = \mathbf{5 \text{ KN/m}^2}$$

Berat pelat tribun

$$\text{Pelat} = \left[\left(\frac{0,12}{\cos 27^\circ} \right) + \left(\frac{0,4}{2} \right) \right] \times 24 = 8,36 \text{ KN/m}^2$$

$$\text{Kedap air} = 0,03 \times 24 = 0,72 \text{ KN/m}^2$$

$$\text{Spesi} = 0,03 \times 24 = 0,72 \text{ KN/m}^2$$

$$\mathbf{W_D = 9,8 \text{ KN/m}^2}$$

$$\text{Beban hidup pelat tribun (W}_L\text{)} = \mathbf{5 \text{ KN/m}^2}$$

Pembebanan Balok Portal

Distribusi beban gravitasi dari pelat ke balok portal pada elevasi lantai +5.000 ditunjukkan gambar 5.4 dibawah ini.

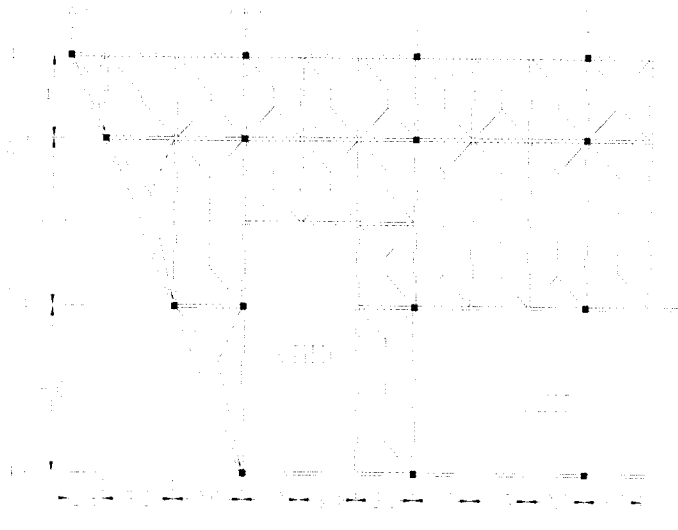

Gambar 5.4 Distribusi Beban (elevasi lantai +5.000)

Distribusi beban gravitasi dari pelat ke balok portal pada elevasi lantai +9.000 ditunjukkan gambar 5.5 dibawah ini.

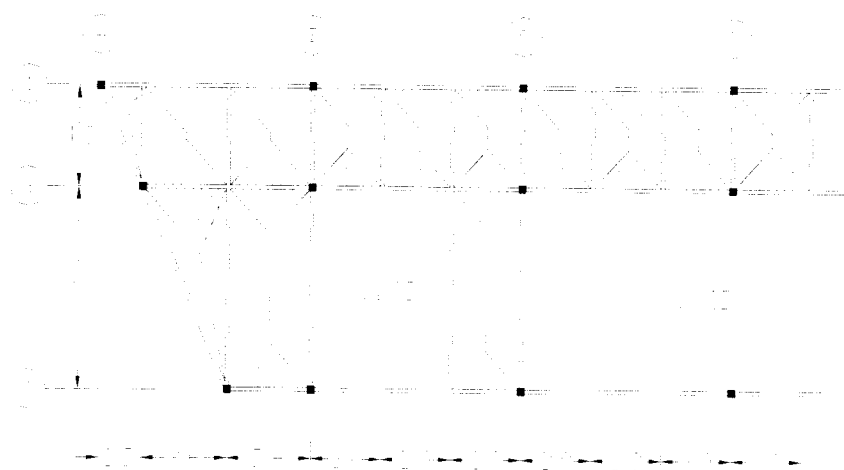

Gambar 5.5 Distribusi Beban (elevasi lantai +9.000)

Distribusi beban gravitasi dari pelat ke balok portal pada elevasi lantai +13.000 ditunjukkan gambar 5.6 dibawah ini.

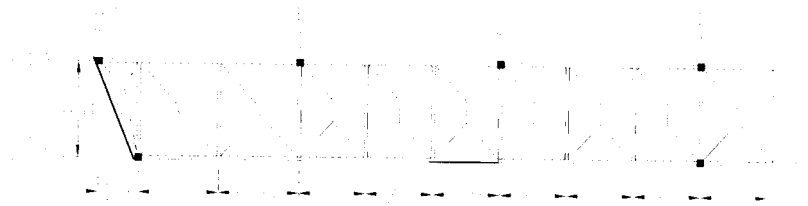

Gambar 5.6 Distribusi Beban (elevasi lantai +13.000)

Pembebanan Balok Portal

Pembebanan gravitasi dari pelat ke balok portal 1 ditunjukkan gambar 5.6 dibawah ini.

o Portal 1

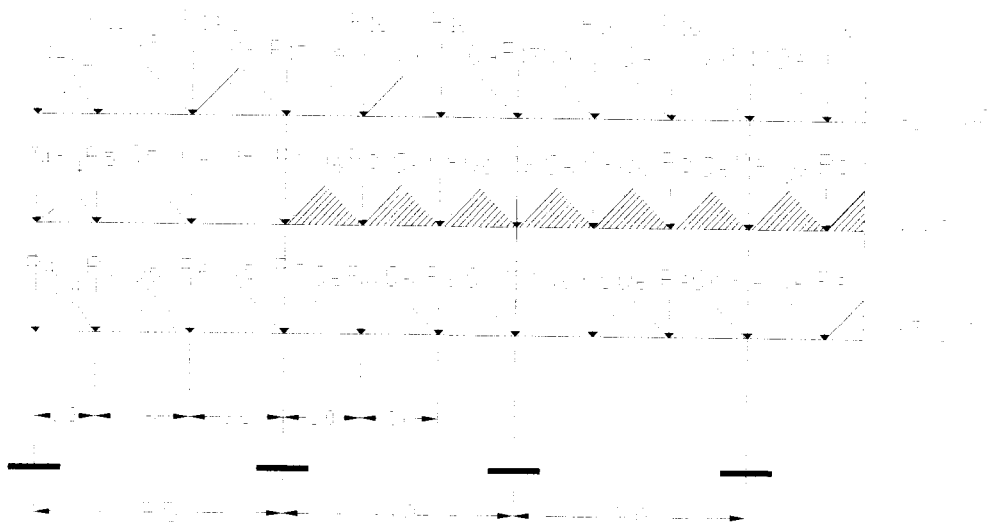

Gambar 5.6 Pembebanan Balok Portal 1

Beban merata

- Tipe 4

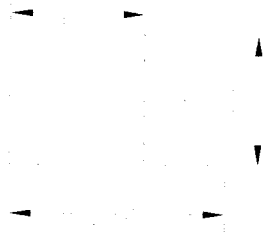

$$Q_{D4} = 4,64 \times 1,33 = 6,17 \text{ KN/m}$$

$$Q_{L4} = 5 \times 1,33 = 6,65 \text{ KN/m}$$

- Tipe 5

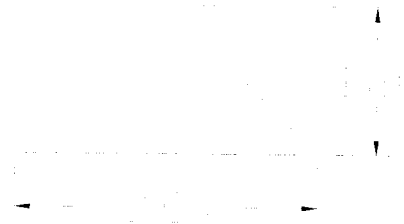

$$Q_{D5} = 4,64 \times 1,8 = 8,352 \text{ KN/m}$$

$$Q_{L5} = 5 \times 1,8 = 9 \text{ KN/m}$$

- Tipe 6

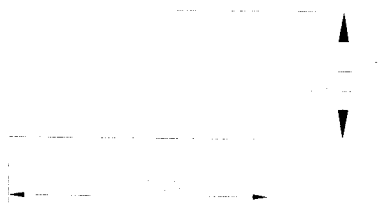

$$Q_{D6} = 4,64 \times 1,5 = 6,96 \text{ KN/m}$$

$$Q_{L6} = 5 \times 1,5 = 7,5 \text{ KN/m}$$

- Tipe 7



$$Q_{D7} = 4,64 \times 1,33 = 5,746 \text{ KN/m}$$

$$Q_{L7} = 5 \times 1,33 = 6,65 \text{ KN/m}$$

- Tipe 8

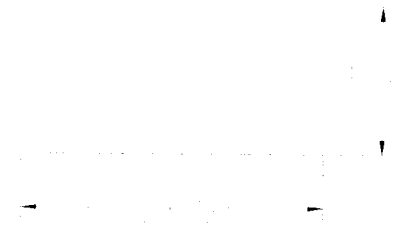

$$Q_{D8} = 4,64 \times 1,8 = 7,776 \text{ KN/m}$$

$$Q_{L8} = 5 \times 1,8 = 9 \text{ KN/m}$$

- Tipe 9

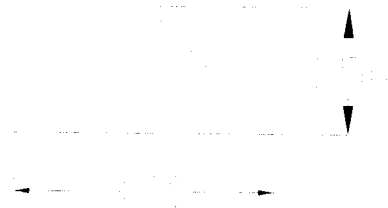

$$Q_{D9} = 4,64 \times 1,5 = 6,48 \text{ KN/m}$$

$$Q_{L9} = 5 \times 1,5 = 7,5 \text{ KN/m}$$

- Tipe 10

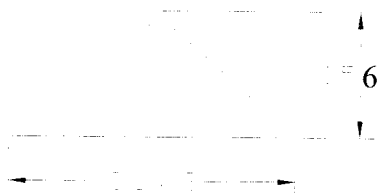

$$Q_{D9} = 4,64 \times 1,56 = 6,48 \text{ KN/m}$$

$$Q_{L9} = 5 \times 1,56 = 7,5 \text{ KN/m}$$

Beban titik

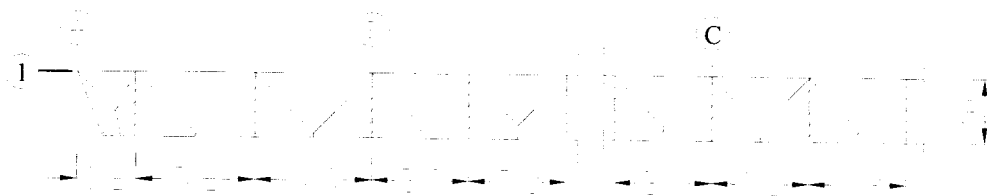

Gambar 5.7 Distribusi Beban Titik Portal 1

- Tipe 4

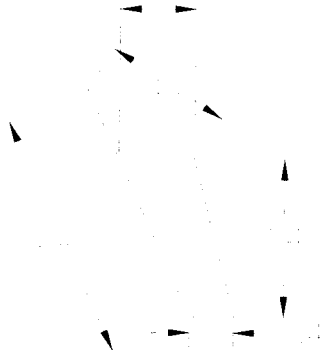

$$A_1 = 0,5 \times 1,1 \times 0,7 = 0,385 \text{ m}^2$$

$$A_2 = \left[\frac{0,4 + 0,7}{2} \right] \cdot 1,4 = 1,015 \text{ m}^2$$

$$A_{\text{total}} = 0,385 + 1,015 = 1,4 \text{ m}^2$$

$$P_{D4} = (4,64 \times 1,4) + (1,226 \times 2,2) = 9,19 \text{ KN}$$

$$P_{L4} = (5 \times 1,4) = 7 \text{ KN}$$

- Tipe 5



$$A_1 = 0,5 \times 0,6 \times 0,8 = 0,399 \text{ m}^2$$

$$A_2 = \left(\frac{0,2 + 2}{2} \right) \cdot 1,8 = 1,98 \text{ m}^2$$

$$A_3 = \left(\frac{0,5 + 0,6}{2} \right) \cdot 1,4 = 0,77 \text{ m}^2$$

$$A_{\text{total}} = 0,399 + 1,98 + 0,77 = 3,15 \text{ m}^2$$

$$P_{D5} = (4,64 \times 3,15) + (0,832 \times 2) = 16,336 \text{ KN}$$

$$P_{L5} = 5 \times 3,15 = 15,75 \text{ KN}$$

- Tipe 6

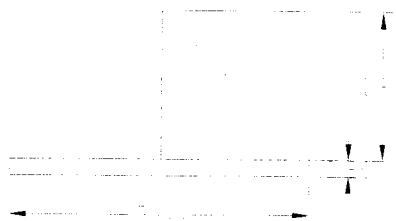

$$A_1 = 0,5 \times 3,6 \times 1,8 = 3,24 \text{ m}^2$$

$$A_2 = 3,6 \times 0,2 = 0,72 \text{ m}^2$$

$$A_{\text{total}} = 3,24 + 0,72 = 3,96 \text{ m}^2$$

$$P_{D6} = (4,64 \times 3,96) + (0,832 \times 2) = 20,04 \text{ KN}$$

$$P_{L6} = 5 \times 3,96 = 19,8 \text{ KN}$$

- Tipe 7

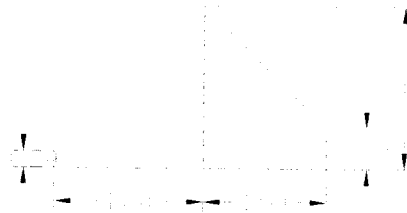

$$A_1 = \left(\frac{0,5 + 2}{2} \right) \cdot 1,5 = 1,875 \text{ m}^2$$

$$A_2 = \left(\frac{0,2 + 2}{2} \right) \cdot 1,8 = 1,98 \text{ m}^2$$

$$A \text{ total} = 1,875 + 1,98 = 3,855 \text{ m}^2$$

$$P_{D7} = (4,64 \times 3,855) + (1,226 \times 2) = 20,34 \text{ KN}$$

$$P_{L7} = 5 \times 3,855 = 19,275 \text{ KN}$$

- Tipe 8

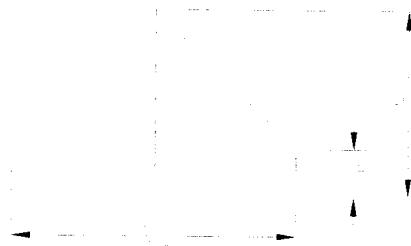

$$A = \left(\frac{0,5 + 2}{2} \right) \cdot 1,5 \times 2 = 3,75 \text{ m}^2$$

$$P_{D8} = (4,64 \times 3,75) + (0,832 \times 2) = 20,34 \text{ KN}$$

$$P_{L8} = (5 \times 3,75) = 18,75 \text{ KN}$$

- Tipe 9

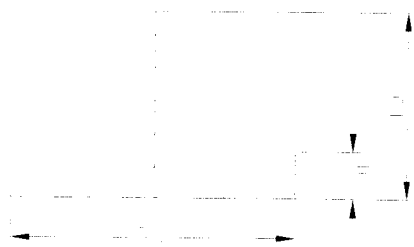

$$A = \left(\frac{0,5 + 2}{2} \right) \cdot 1,5 \times 2 = 3,75 \text{ m}^2$$

$$P_{D9} = (4,64 \times 3,75) + (1,226 \times 2) = 19,852 \text{ KN}$$

$$P_{L9} = (5 \times 3,75) = 18,75 \text{ KN}$$

- Tipe 10

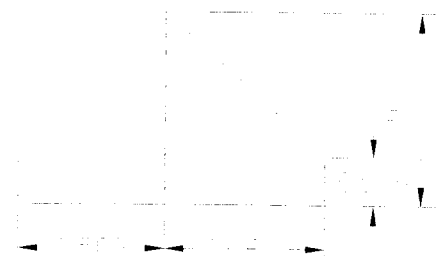

$$A_1 = \left(\frac{0,5 + 2}{2} \right) \cdot 1,5 = 1,875 \text{ m}^2$$

$$A_2 = \left(\frac{0,5 + 2}{2} \right) \cdot 1,667 = 2,08 \text{ m}^2$$

$$A \text{ total} = 1,875 + 2,08 = 3,96 \text{ m}^2$$

$$P_{DI0} = (4,64 \times 3,96) + (1,226 \times 2) = 20,83 \text{ KN}$$

$$P_{LI0} = (5 \times 3,96) = 19,8 \text{ KN}$$

- Tipe 11

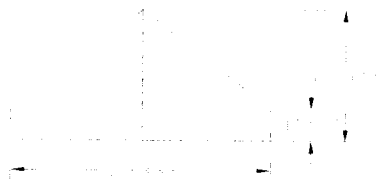

$$A = \left(\frac{0,5 + 2}{2} \right) 1,667 \times 2$$

$$= 4,16 \text{ m}^2$$

$$P_{DII} = (4,64 \times 4,16) + (0,832 \times 2) = 20,966 \text{ KN}$$

$$P_{LII} = (5 \times 4,16) = 20,8 \text{ KN}$$

- **Portal 2**

Pembebanan gravitasi dari pelat ke balok portal 2 ditunjukkan gambar 5.9a dan 5.9b dibawah ini.

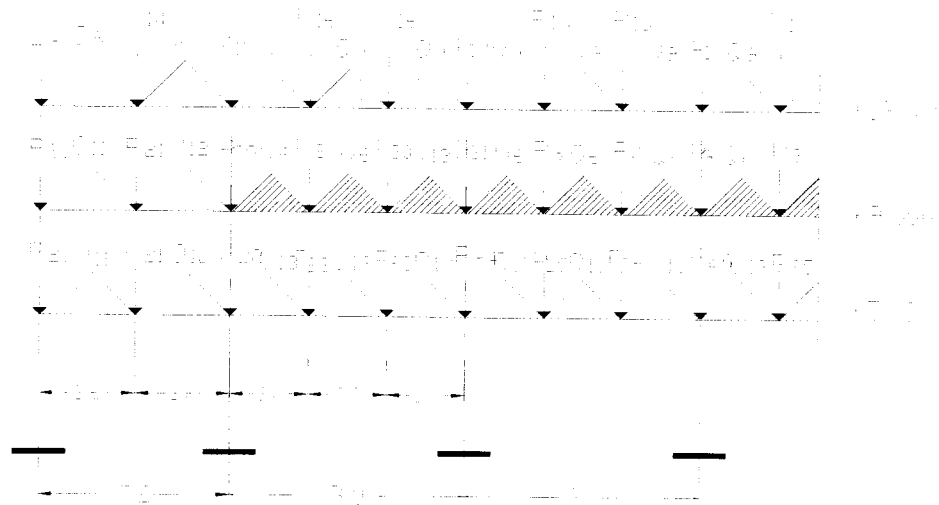

Gambar 5.9a Pembebanan Balok Portal 2 Akibat Pelat Lantai

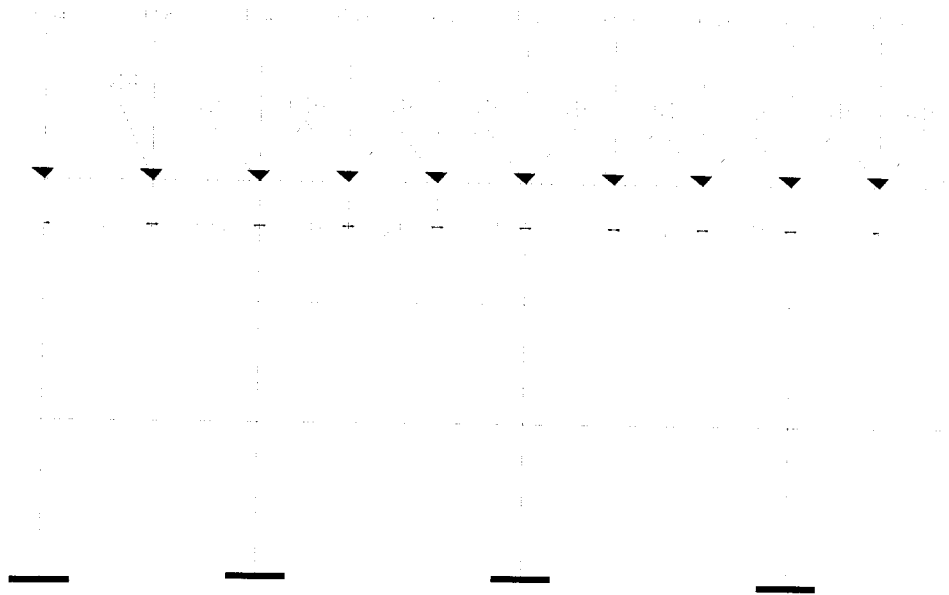

Gambar 5.9b Pembebanan Balok Portal 2 Akibat Pelat Tribun

Beban merata

- Tipe 11



$$Q_{D11a} = 4,64 \times 1,8 = 8,352 \text{ KN/m}$$

$$Q_{D11b} = 4,64 \times 2,67 = 12,39 \text{ KN/m}$$

$$Q_{L11a} = 5 \times 1,8 = 9 \text{ KN/m}$$

$$Q_{L11b} = 5 \times 2,67 = 13,35 \text{ KN/m}$$

- Tipe 12

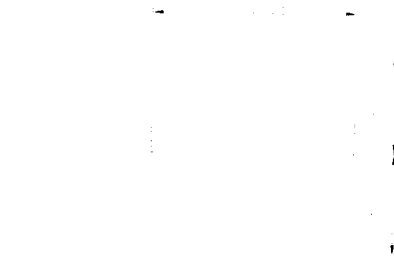

$$Q_{D12} = 2 \times 4,64 \times 1,8 = 16,704 \text{ KN/m}$$

$$Q_{L12} = 2 \times 5 \times 1,8 = 18 \text{ KN/m}$$

- Tipe 13

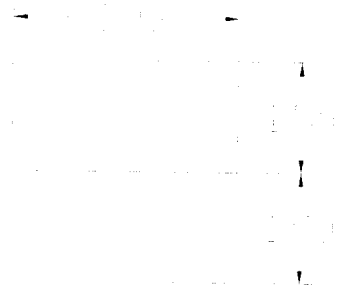

$$Q_{D13} = 2 \times 1,5 \times 4,64 = 13,92 \text{ KN/m}$$

$$Q_{L13} = 2 \times 1,5 \times 5 = 15 \text{ KN/m}$$

- Tipe 14

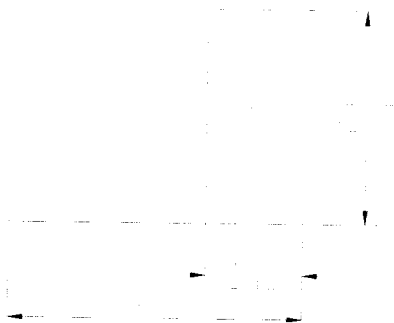

$$Q_{D14} = 2,7 \times 9,8 = 26,46 \text{ KN/m}$$

$$Q_{L14} = 2,7 \times 5 = 13,5 \text{ KN/m}$$

- Tipe 15



$$Q_{D15} = 2 \times 9,8 = 19,6 \text{ KN/m}$$

$$Q_{L15} = 2 \times 5 = 10 \text{ KN/m}$$

- Tipe 16

$$Q_{D16} = 2 \times 9,8 = 19,6 \text{ KN/m}$$

$$Q_{L16} = 2 \times 5 = 10 \text{ KN/m}$$

Beban titik

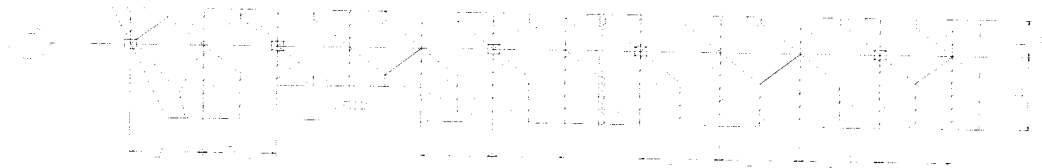

Gambar 5.10a Distribusi Beban Titik Portal 2 Elevasi +5.000

- Tipe 20

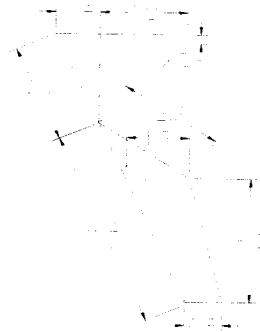

$$A_1 = \left(\frac{0,2 + 2}{2} \right) \cdot 1,8 = 1,98 \text{ m}^2$$

$$A_2 = 0,5 \times 0,9 \times 2 = 0,9 \text{ m}^2$$

$$A_3 = 0,5 \times 1,3 \times 2,2 = 1,43 \text{ m}^2$$

$$A_4 = \left(\frac{1,3 + 0,8}{2} \right) \cdot 2,8 = 2,94 \text{ m}^2$$

$$A_{\text{total}} = 1,98 + 1,43 + 0,9 + 2,94 = 7,25 \text{ m}^2$$

$$P_{D20} = (4,64 \times 7,25) + (0,832 \times 2) + (1,226 \times 6,6) = 43,4 \text{ KN}$$

$$P_{L20} = (5 \times 7,25) = 36,25 \text{ KN}$$

- Tipe 21

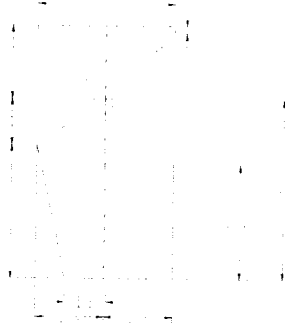

$$A_1 = \left(\frac{0,2 + 2}{2} \right) \cdot 1,8 \times 2 = 3,96 \text{ m}^2$$

$$A_2 = \left(\frac{2,2 + 4}{2} \right) \cdot 1,8 = 5,58 \text{ m}^2$$

$$A_3 = 0,5 \times 1 \times 1,8 = 1,602 \text{ m}^2$$

$$A_4 = \left(\frac{1,1 + 1,8}{2} \right) \cdot 3 = 4,35 \text{ m}^2$$

$$A_{\text{total}} = 3,96 + 5,58 + 1,602 + 4,35 = 15,539 \text{ m}^2$$

$$P_{D21} = (4,64 \times 15,539) + (0,832 \times 6) = 63,173 \text{ KN}$$

$$P_{L21} = (5 \times 12,539) = 62,695 \text{ KN}$$

- Tipe 22

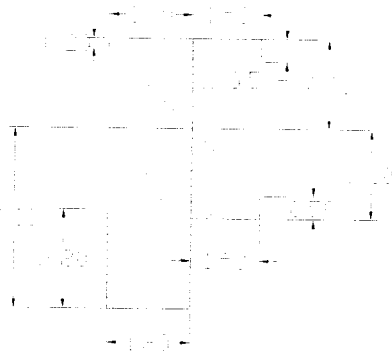

$$A_1 = \left(\frac{0,2 + 2}{2} \right) \cdot 1,8 = 1,98 \text{ m}^2$$

$$A_2 = \left(\frac{2,2 + 4}{2} \right) \cdot 1,8 = 5,58 \text{ m}^2$$

$$A_3 = \left(\frac{0,5 + 2}{2} \right) \cdot 1,5 \times 2 = 3,75 \text{ m}^2$$

$$A_{\text{total}} = 1,98 + 5,58 + 3,75 = 11,31 \text{ m}^2$$

$$P_{D22} = (4,64 \times 11,31) + (1,226 \times 6) = 59,834 \text{ KN}$$

$$P_{L22} = (5 \times 11,31) = 56,55 \text{ KN}$$

- Tipe 23

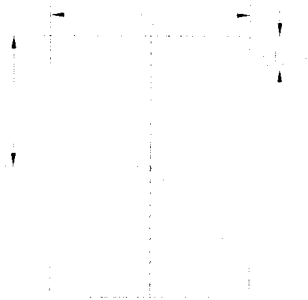

$$A = \left(\frac{0,5 + 2}{2} \right) \cdot 1,5 \times 4 = 7,5 \text{ m}^2$$

$$P_{D23} = (4,64 \times 7,5) + (0,832 \times 4) = 38,128 \text{ KN}$$

$$P_{L23} = (5 \times 7,5) = 37,5 \text{ KN}$$

- Tipe 24

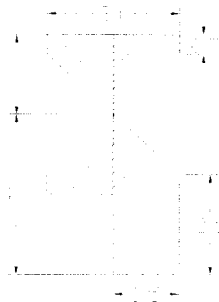

$$A_1 = \left(\frac{2,5 + 4}{2} \right) \cdot 1,5 = 4,875 \text{ m}^2$$

$$A_2 = \left(\frac{0,5 + 2}{2} \right) \cdot 1,5 \times 3 = 5,625 \text{ m}^2$$

$$A \text{ total} = 4,875 + 5,625 = 10,5 \text{ m}^2$$

$$P_{D24} = (4,64 \times 10,5) + (1,226 \times 6) = 56,076 \text{ KN}$$

$$P_{L24} = (5 \times 10,5) = 52,5 \text{ KN}$$

- Tipe 25

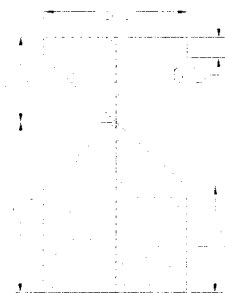

$$A_1 = \left(\frac{2,5 + 4}{2} \right) \cdot 1,5 \times 2 = 9,75 \text{ m}^2$$

$$A_2 = \left(\frac{0,5 + 2}{2} \right) \cdot 1,5 \times 2 = 3,75 \text{ m}^2$$

$$A \text{ total} = 9,75 + 3,75 = 13,5 \text{ m}^2$$

$$P_{D25} = (4,64 \times 13,5) + (0,832 \times 6) = 67,632 \text{ KN}$$

$$P_{L25} = (5 \times 13,5) = 67,5 \text{ KN}$$

○ **Portal C**

Pembebanan gravitasi dari pelat ke balok portal C ditunjukkan gambar 5.9a dibawah ini.

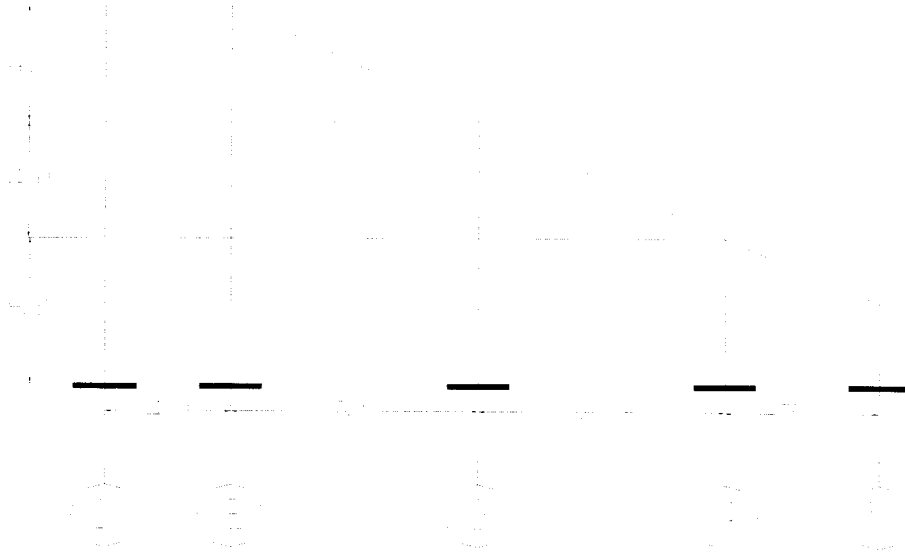

Gambar 5.9 Portal C

Beban merata lantai 2.5

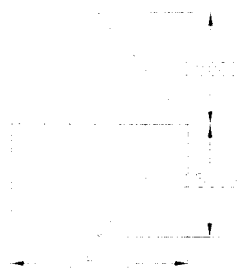

$$Q_{D10} = 4.64 \times 1,5 \times 2 = 12,96 \text{ KN/m}$$

$$Q_{L10} = 5 \times 1,5 \times 2 = 15 \text{ KN/m}$$

beban merata lantai 5.15 & 9.15



$$Q_{D7} = 4,64 \times 1,5 \times 2 = 13,92 \text{ KN/m}$$

$$Q_{L7} = 5 \times 1,5 \times 2 = 15 \text{ KN/m}$$

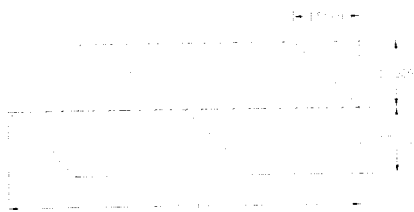

$$Q_{D1} = 4,64 \times 1,5 = 6,96 \text{ KN/m}$$

$$Q_{L1} = 5 \times 1,5 = 7,5 \text{ KN/m}$$

$$Q_{D7a} = 4,64 \times 1,5 = 6,96 \text{ KN/m}$$

$$Q_{L7a} = 5 \times 1,5 = 7,5 \text{ KN/m}$$

$$Q_{D7b} = 4,64 \times 1,5 = 6,96 \text{ KN/m}$$

$$Q_{L7b} = 5 \times 1,5 = 7,5 \text{ KN/m}$$

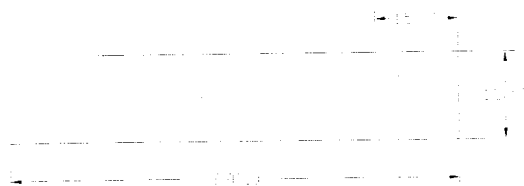

$$Q_{D1} = 4,64 \times 1,5 = 6,96 \text{ KN/m}$$

$$Q_{L1} = 5 \times 1,5 = 7,5 \text{ KN/m}$$

Beban merata lantai 13.15



$$Q_{D2} = 4,64 \times 1,5 \times 2 = 12,96 \text{ KN/m}$$

$$Q_{L2} = 5 \times 1,5 \times 2 = 15 \text{ KN/m}$$

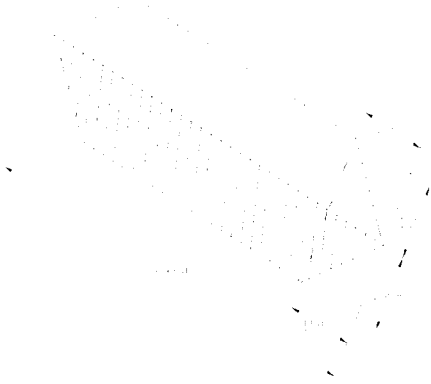

$$Q_{D2} = 9,8 \times 1,5 \times 2 = 12,96 \text{ KN/m}$$

$$Q_{L2} = 5 \times 1,5 \times 2 = 15 \text{ KN/m}$$

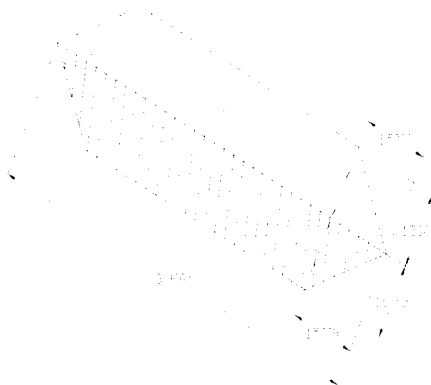

$$Q_{D2} = 9,8 \times 1,5 \times 2 = 12,96 \text{ KN/m}$$

$$Q_{L2} = 5 \times 1,5 \times 2 = 15 \text{ KN/m}$$

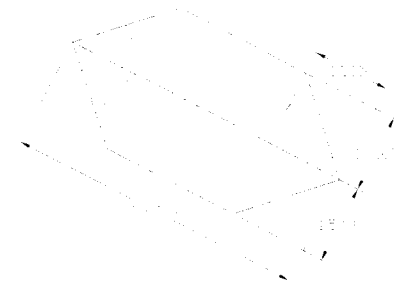

$$Q_{D2} = 9,8 \times 1,5 \times 2 = 12,96 \text{ KN/m}$$

$$Q_{L2} = 5 \times 1,5 \times 2 = 15 \text{ KN/m}$$

o **Beban titik lantai 5.150**



$$P_D = \left(\frac{1}{2} \times 1,5 \times 1,5 \times 2 \times 4,64 \right) + (1,444 \times 3) = 14,768 \text{ KN}$$

$$P_L = \left(\frac{1}{2} \times 1,5 \times 1,5 \times 2 \times 5 \right) = 11,25 \text{ KN}$$



$$P_D = \left(\frac{1}{2} \times 3 \times 1,5 \times 2 \times 4,64 \right) + (1,444 \times 3) = 25,212 \text{ KN}$$

$$P_L = \left(\frac{1}{2} \times 3 \times 1,5 \times 2 \times 5 \right) = 22,5 \text{ KN}$$



$$P_D = \left(\frac{1}{2} \times 3 \times 1,5 \times 4,64 \right) + (0,832 \times 1,5) = 11,688 \text{ KN}$$

$$P_L = \left(\frac{1}{2} \times 3 \times 1,5 \times 5 \right) = 11,25 \text{ KN}$$



$$P_D = \left(\frac{1}{2} \times 1,5 \times 1,5 \times 4,64 \right) + (1,444 \times 1,5) = 6,664 \text{ KN}$$

$$P_L = \left(\frac{1}{2} \times 1,5 \times 1,5 \times 5 \right) = 5,625 \text{ KN}$$

- Beban titik lantai 9,150

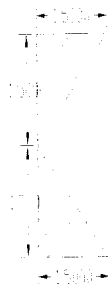

$$P_D = \left(\frac{1}{2} \times 1,5 \times 1,5 \times 2 \times 4,64 \right) + (1,444 \times 3) = 14,76 \text{ KN}$$

$$P_L = \left(\frac{1}{2} \times 1,5 \times 1,5 \times 2 \times 5 \right) = 11,25 \text{ KN}$$



$$P_D = \left(\frac{1}{2} \times 3 \times 1,5 \times 4,64 \right) + (0,832 \times 1,5) = 11,272 \text{ KN}$$

$$P_L = \left(\frac{1}{2} \times 3 \times 1,5 \times 5 \right) = 11,25 \text{ KN}$$



$$P_D = \left(\frac{1}{2} \times 1,5 \times 1,5 \times 4,64 \right) + (1,444 \times 1,5) = 6,664 \text{ KN}$$

$$P_L = \left(\frac{1}{2} \times 1,5 \times 1,5 \times 5 \right) = 5,625 \text{ KN}$$

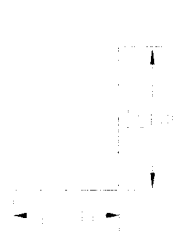

$$P_D = \left(\frac{1}{2} \times 1,5 \times 1,5 \times 4,64 \right) + (1,444 \times 1,5) = 6,664 \text{ KN}$$

$$P_L = \left(\frac{1}{2} \times 1,5 \times 1,5 \times 5 \right) = 5,625 \text{ KN}$$

o **Beban titik lantai 13.150**

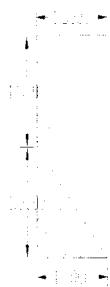

$$P_D = \left(\frac{1}{2} \times 1,5 \times 1,5 \times 2 \times 4,64 \right) + (1,444 \times 3) = 14,768 \text{ KN}$$

$$P_L = \left(\frac{1}{2} \times 1,5 \times 1,5 \times 2 \times 5 \right) = 11,25 \text{ KN}$$

Beban titik pada balok miring



$$P_D = \left(\frac{1}{2} \times 3 \times 1,5 \times 2 \times 9,8 \right) + (1,444 \times 3) = 25,212 \text{ KN}$$

$$P_L = \left(\frac{1}{2} \times 3 \times 1,5 \times 2 \times 5 \right) = 22,5 \text{ KN}$$



$$P_D = \left(\frac{1}{2} \times 3 \times 1,5 \times 2 \times 9,8 \right) + (1,444 \times 3) = 25,212 \text{ KN}$$

$$P_L = \left(\frac{1}{2} \times 3 \times 1,5 \times 2 \times 5 \right) = 22,5 \text{ KN}$$



$$P_D = \left(\frac{1}{2} \times 1,5 \times 1,5 \times 2 \times 9,8 \right) + (1,444 \times 3) = 14,768 \text{ KN}$$

$$P_L = \left(\frac{1}{2} \times 1,5 \times 1,5 \times 2 \times 5 \right) = 11,25 \text{ KN}$$

5.2.2 Beban Gempa

Perhitungan gaya geser dasar horizontal akibat gempa diawali dengan menentukan waktu getar bangunan (T), koefisien gempa dasar (C), factor keutamaan (I), dan factor jenis struktur (K). Selain itu juga dilakukan perhitungan terhadap berat total bangunan (Wt).

1. Berat bangunan

Portal C

a. Lantai 3

Beban mati

Pelat lantai	$= 4,64 \times 4 \times 9$	$= 155,52$	KN
Pelat tribun	$= 9,8 \times 4,49 \times 9$	$= 193,968$	KN
Balok induk	$= 1,444 \times [4 + (2 \cdot 9)]$	$= 31,768$	KN

Balok anak	$= 0,832 \times 4 \times 2$	$= 6,656$	KN
B.miring induk	$= 1,444 \times 4,49$	$= 6,484$	KN
B.miring anak	$= 0,803 \times 2 \times 4,49$	$= 7,211$	KN
Kolom	$= 1,131 \times 2 \times 2$	$= 4,524$	KN
Dinding	$= 2,5 \times 2 \times 9$	$= 45$	KN

$$W_{D3} = 451,131 \text{ KN}$$

Beban hidup

$$Q_L = 4 \text{ KN/m}^2$$

$$\text{Koefisien reduksi} = 0,5$$

$$W_L = 0,5 \times 5 \times [(4 \times 9) + (4,49 \times 9)] = 191,025 \text{ KN}$$

$$\text{Beban total } W_3 = W_D + W_L = 431,734 + 191,025 = 642,156 \text{ KN}$$

b. Lantai 2

Beban mati

Pelat lantai	$= 4,64 \times [(4 \times 9) + (8 \times 9)]$	$= 278,4$	KN
Pelat tribun	$= 9,8 \times 8,98 \times 9$	$= 387,936$	KN
Balok induk	$= 1,444 \times [12 + (3 \cdot 9)]$	$= 56,316$	KN
Balok anak	$= 0,832 \times 4 \times 4$	$= 13,312$	KN
B.miring induk	$= 1,444 \times 8,98$	$= 12,967$	KN
B.miring anak	$= 0,803 \times 2 \times 8,98$	$= 14,422$	KN
Kolom	$= 1,131 \times 3 \times 4$	$= 13,572$	KN
Dinding	$= 2,5 \times 4 \times 9$	$= 90$	KN

$$W_{D2} = 866,925 \text{ KN}$$

Beban hidup

$$Q_L = 4 \text{ KN/m}^2$$

$$\text{Koefisien reduksi} = 0,5$$

$$W_L = 0,5 \times 5 \times [(4 \times 9) + (8 \times 9) + (8,98 \times 9)] = 352,05 \text{ KN}$$

$$\text{Beban total } W_2 = W_D + W_L = 828,131 + 352,05 = 1218,975 \text{ KN}$$

a. Lantai 1

Beban mati

$$\text{Pelat lantai} = 4,64 \times [(4 \times 9) + (2 \times 8 \times 9)] = 584,64 \text{ KN}$$

$$\text{Pelat tribun} = 9,8 \times 10,1 \times 9 = 436,32 \text{ KN}$$

$$\text{Pelat kantilever} = 4,64 \times 9 \times 2,5 = 97,2 \text{ KN}$$

$$\text{Balok induk} = 1,444 \times [20 + 15 + (2 \cdot 9)] = 65,702 \text{ KN}$$

$$\text{Balok anak} = 0,832 \times [20 + 12 + 4,5] = 30,368 \text{ KN}$$

$$\text{B.miring induk} = 1,444 \times 10,1 = 14,584 \text{ KN}$$

$$\text{B.miring anak} = 0,803 \times 2 \times 10,1 = 16,221 \text{ KN}$$

$$\text{Kolom} = 1,131 \times 4,575 \times 4 = 20,697 \text{ KN}$$

$$\text{Dinding} = 2,5 \times 4,575 \times 9 = 102,938 \text{ KN}$$

$$W_{D1} = 1368,67 \text{ KN}$$

Beban hidup

$$Q_L = 4 \text{ KN/m}^2$$

$$\text{Koefisien reduksi} = 0,5$$

$$\begin{aligned} W_L &= 0,5 \times 5 \times [(4 \times 9) + (10,1 \times 9) + (2 \times 8 \times 9) + (9 \times 2,5)] \\ &= 598,5 \text{ KN} \end{aligned}$$

Beban total $W_1 = W_D + W_L = 1325,038 + 598,5 = 1967,17 \text{ KN}$

Maka berat total bangunan :

$$\begin{aligned} W_t &= W_1 + W_2 + W_3 \\ &= 1967,17 + 1218,975 + 642,156 \\ &= 3828,301 \text{ KN} \end{aligned}$$

2. Beban Gempa

a) Waktu getar bangunan (T)

Dengan rumus empiris :

$$T_x = T_y = 0,085 \cdot H^{3/4} \rightarrow H = 13,15 \text{ m}$$

$$T_x = T_y = 0,085 \cdot 13,15^{3/4} = 0,587 \text{ detik}$$

b) Koefisien Gempa Dasar (C)

Koefisien gempa dasar (C) diperoleh dari gambar 3.1 sesuai dengan pedoman perencanaan ketahanan gempa untuk rumah dan gedung 1987.

Dengan : $T = 0,587 \text{ detik}$, Daerah gempa 3

Jenis tanah adalah tanah lunak

Maka dari Respon Spektra diperoleh nilai $C = 0,07$

c) Faktor Keutamaan (I) dan Faktor Jenis Struktur (K)

Berdasarkan PPKGURDG, 1987 diperoleh $I = 1,5$ dan $K = 1$

d) Gaya Geser Dasar (V)

$$V = C.I.K.Wt \dots\dots\dots (3.1)$$

$$= 0,07. 1,5. 1. 3828,301 = 401,972 \text{ KN}$$

e) Distribusi Gaya Horizontal Tingkat

$$H = 13,15 \text{ m}, B = 20 \text{ m}$$

$$\frac{H}{B} = \frac{13,15}{20} = 0,6575 < 3$$

Maka seluruh beban didistribusikan sebagai gaya horizontal dengan menggunakan persamaan (3.3) :

$$F_i = \frac{W_i.h_i}{\sum W_i.h_i} \times V \dots\dots\dots (3.3)$$

Tabel 5.1 Hitungan Gaya Horizontal Portal C

No	Bagian	W _i	H _i	W _i H _i	F _{x,y}
1	tingkat 3	642.156	13.15	8444.351	114.178
2	tingkat 2	1218.975	9.15	11153.621	150.811
3	tingkat 1	1967.17	5.15	10130.926	136.983
			W _i H _i	29728.898	

Tabel hitungan gaya horizontal akibat gempa dapat dilihat pada lampiran 1.

5.3 Perencanaan Balok

5.3.1 Perencanaan Balok Portal As B

a. Analisis dua dimensi (2D)

Kombinasi beban gempa dan gravitasi

Balok B2 (Batang 2)

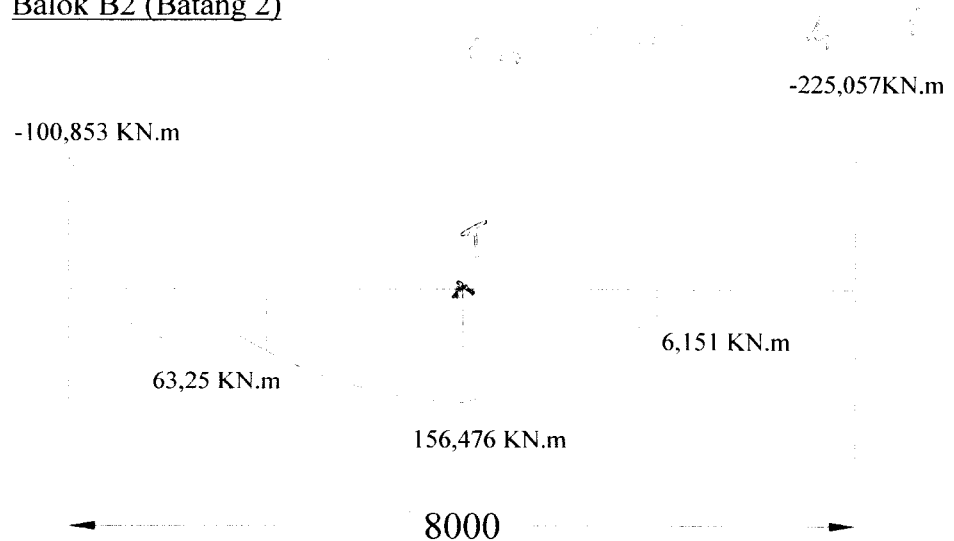

Gambar 5.12 Bending Momen

Bentang yang terjadi lengkung ganda (double curvature)

$M_u = 225,057 \text{ KN.m}$ (Lampiran A4)

$$C_b = \frac{12,5 \cdot M_{maks}}{2,5 \cdot M_{maks} + 3M_A + 4M_B + 3M_C} \leq 2,3 \dots\dots\dots (3.16)$$

$$= \frac{12,5 \cdot 225,057}{2,5 \cdot 225,057 + 3 \cdot 63,253 + 4 \cdot 156,476 + 3 \cdot 6,151}$$

$$= 2,01 < 2,3$$

Dipakai profil W16X36 ($r_y = 38,61 \text{ mm}$; $Z_x = 1048772,1 \text{ mm}^3$;

$X_1 = 11721,5 \text{ MPa}$; $X_2 = 438 \cdot 10^{-6} (1/\text{MPa})^2$; $S_x = 925869,12 \text{ mm}^3$)

Cek penampang kompak :

Rasio lebar sayap terhadap tebal sayap

$$\frac{b}{2.t_f} \leq \frac{171}{\sqrt{F_y}} \dots\dots\dots (3.11)$$

$$\frac{177,419}{2.10,922} = 8,122 \leq \frac{171}{\sqrt{250}} = 10,815$$

Rasio tinggi badan terhadap tebal badan

$$\frac{d}{t_w} \leq \frac{1680}{\sqrt{F_y}} \dots\dots\dots (3.12)$$

$$\frac{402,844}{7,493} = 53,763 \leq \frac{1680}{\sqrt{250}} = 106$$

$$L_p = 1,76.r_y.\sqrt{\frac{E}{f_y}} = 1,76.38,61\sqrt{\frac{2.10^5}{250}} = 1921,92 \text{ mm}$$

$$L_r = \frac{r_y.X_1}{(f_y - f_r)} \cdot \sqrt{1 + \sqrt{1 + X_2 \cdot (f_y - f_r)^2}} \dots\dots\dots (3.15)$$

$$= \frac{38,61.11721,5}{(250 - 70)} \cdot \sqrt{1 + \sqrt{1 + 438.10^{-6} \cdot (250 - 70)^2}}$$

$$= 5562,76 \text{ mm}$$

$$L = 4 \text{ m} = 4000 \text{ mm}$$

$$L_p = 19121,92 \text{ mm} < L_b = 4000 \text{ mm} < L_r = 5562,76 \text{ mm}$$

Maka kuat nominal komponen struktur terhadap momen lentur adalah

$$M_n = C_b \cdot \left[M_r + (M_p - M_r) \cdot \frac{(L_r - L)}{(L_r - L_p)} \right] \leq M_p \dots\dots\dots (3.14)$$

dengan:

$$\begin{aligned} M_p &= Z_x \cdot F_y = 1048772,1 \times 250 \\ &= 262,19 \cdot 10^6 \text{ N.mm} = 262,19 \text{ KN.m} \end{aligned}$$

$$\begin{aligned} M_r &= (f_y - f_r) \cdot S_x = (250 - 70) \cdot 925869,12 \\ &= 166,66 \cdot 10^6 \text{ N.mm} = 166,66 \text{ KN.m} \end{aligned}$$

Maka :

$$\begin{aligned} M_n &= 2,01 \cdot \left[166,66 + (262,19 - 166,66) \cdot \frac{(5,563 - 4)}{(5,563 - 1,922)} \right] \\ &= 418,26 \text{ KN.m} > M_p = 262,19 \text{ KN.m} \end{aligned}$$

$$M_n \text{ pakai} = 262,19 \text{ KN.m}$$

$$0,9 \cdot M_n = 0,9 \cdot 262,19 = 235,971 \text{ KN.m} > M_u = 215,057 \text{ KN.m}$$

AMAN

$$\frac{235,971}{225,057} = 1,1 < 1,25 \text{ (sesuai dengan batasan yang kami tentukan)}$$

Kontrol Defleksi

Dari Program SAP 2000 didapatkan defleksi profil balok W16x36 ditengah bentang adalah 1,16 cm

$$\text{Maksimum defleksi diizinkan adalah} = \frac{8}{360} = 0,022 \text{ m} = 2,2 \text{ cm}$$

Profil balok W16x36 dapat digunakan

Kuat Tarik yang tersedia

P aksial balok = 77,774 KN (Lampiran A12)

Profil balok W16x36 (Ag = 6838,696 mm²)

Kuat tarik yang tersedia = 0,9 . fy . Ag (3.19b)

$$= 0,9 . 250 . 6838,696 = 1538706,6 \text{ N}$$

$$= 1538,707 \text{ KN} > P = 77,774 \text{ KN}$$

b. Analisis tiga dimensi (3D)

Kombinasi beban gempa dan gravitasi

Balok B2

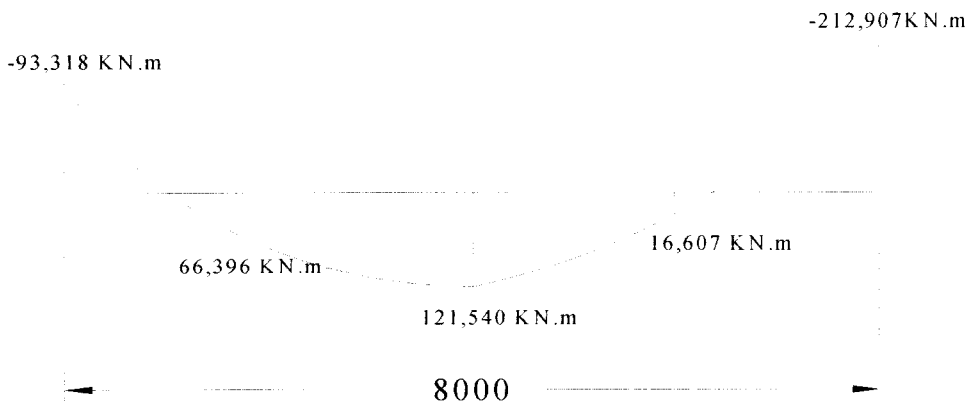

Gambar 5.12 Bending Momen

Bentang yang terjadi lengkung ganda (double curvature)

Mu = 212,907 KN.m (Lampiran A8)

$$Cb = \frac{12,5.M_{maks}}{2,5.M_{maks} + 3M_A + 4M_B + 3M_C} \leq 2,3 \dots\dots\dots (3.16)$$

$$= \frac{12,5 \cdot 212,907}{2,5 \cdot 212,907 + 3 \cdot 66,396 + 4 \cdot 121,54 + 3 \cdot 16,607}$$

$$= 2,1 < 2,3$$

Dipakai profil W16X36 (ry = 38,61 mm; Zx = 1048772,1 mm³;

X₁ = 11721,5 MPa; X₂ = 438.10⁻⁶ (1/MPa)²; Sx = 925869,12 mm³)

Cek penampang kompak

Rasio lebar sayap terhadap tebal sayap

$$\frac{b}{2 \cdot t_f} \leq \frac{171}{\sqrt{F_y}} \dots\dots\dots (3.11)$$

Rasio tinggi badan terhadap tebal badan

$$\frac{177,419}{2 \cdot 10,922} = 8,122 \leq \frac{171}{\sqrt{250}} = 10,815$$

$$\frac{d}{t_w} \leq \frac{640}{\sqrt{F_y}} \dots\dots\dots (3.12)$$

$$\frac{402,844}{7,493} = 53,763 \leq \frac{1680}{\sqrt{250}} = 106$$

$$L_p = 1,76 \cdot r_y \cdot \sqrt{\frac{E}{f_y}} = 1,76 \cdot 38,61 \cdot \sqrt{\frac{2 \cdot 10^5}{250}} = 1921,92 \text{ mm}$$

$$L_r = \frac{r_y \cdot X_1}{(f_y - f_r)} \cdot \sqrt{1 + \sqrt{1 + X_2 \cdot (f_y - f_r)^2}} \dots\dots\dots (3.15)$$

$$= \frac{38,61 \cdot 11721,5}{(250 - 70)} \cdot \sqrt{1 + \sqrt{1 + 438 \cdot 10^{-6} \cdot (250 - 70)^2}}$$

$$= 5562,76 \text{ mm}$$

$$L = 4 \text{ m} = 4000 \text{ mm}$$

$$L_p = 19121,92 \text{ mm} < L_b = 4000 \text{ mm} < L_r = 5562,76 \text{ mm}$$

Maka kuat nominal komponen struktur terhadap momen lentur adalah

$$M_n = C_b \cdot \left[M_r + (M_p - M_r) \cdot \frac{(L_r - L)}{(L_r - L_p)} \right] \leq M_p \dots\dots\dots (3.14)$$

dengan:

$$\begin{aligned} M_p &= Z_x \cdot F_y = 1048772,1 \times 250 \\ &= 262,19 \cdot 10^6 \text{ N.mm} = 262,19 \text{ KN.m} \end{aligned}$$

$$\begin{aligned} M_r &= (f_y - f_r) \cdot S_x = (250 - 70) \cdot 925869,12 \\ &= 166,66 \cdot 10^6 \text{ N.mm} = 166,66 \text{ KN.m} \end{aligned}$$

Maka :

$$\begin{aligned} M_n &= 2,1 \cdot \left[166,66 + (262,19 - 166,66) \cdot \frac{(5,563 - 4)}{(5,563 - 1,922)} \right] \\ &= 436,05 \text{ KN.m} > M_p = 262,19 \text{ KN.m} \end{aligned}$$

$$M_n \text{ pakai} = 262,19 \text{ KN.m}$$

$$0,9 \cdot M_n = 0,9 \cdot 262,19 = 235,971 \text{ KN.m} > M_u = 212,907 \text{ KN.m}$$

AMAN

$$\frac{235,971}{212,907} = 1,12 < 1,25 \text{ (sesuai dengan batasan yang kami tentukan)}$$

Kontrol Defleksi

Dari Program SAP 2000 didapatkan defleksi profil balok W16x36 ditengah bentang adalah 0,61 cm

$$\text{Maksimum defleksi diizinkan adalah} = \frac{8}{360} = 0,022 \text{ m} = 2,2 \text{ cm}$$

Profil balok W16x36 dapat digunakan

Kuat Tarik yang tersedia

P aksial balok = 79,437 KN (Lampiran A16)

Profil balok W16x36 (Ag = 6838,696 mm²)

Kuat tarik yang tersedia = 0,9 . fy . Ag (3.19b)

$$= 0,9 . 250 . 6838,696 = 1538706,6 \text{ N}$$

$$= 1538,707 \text{ KN} > P = 79,437 \text{ KN}$$

Perhitungan perencanaan balok selanjutnya dapat dilihat pada lampiran D.

5.3.2 Gaya Geser Rencana Balok

a. Analisis dua dimensi (2D)

Gaya geser pada balok B₂ portal B adalah (Lihat lampiran A17)

$$V_D = 53,186 \text{ KN}$$

$$V_L = 61,277 \text{ KN}$$

$$V_E = 12,758 \text{ KN}$$

Gaya geser balok diambil dari nilai minimum dua persamaan berikut :

$$V_u = 1,2.V_D + 0,5.V_L + \frac{2.M_{pb}}{L'} \dots\dots\dots (3.20a)$$

$$= 1,2. 53,186 + 0,5. 61,277 + \frac{2.262,19}{7,54} = 170,964 \text{ KN}$$

$$V_u = 1,2.V_D + 0,5.V_L + \mu.V_E \dots\dots\dots (3.20b)$$

$$= 1,2. 53,186 + 0,5. 61,277 + 4. 12,758 = 145,494 \text{ KN}$$

Gaya geser rencana balok adalah 145,494 KN

b. Analisis tiga dimensi (3D)

Gaya geser pada balok B₂ portal B adalah (Lihat lampiran A18)

$$V_D = 57,151 \text{ KN}$$

$$V_L = 43,656 \text{ KN}$$

$$V_E = 11,552 \text{ KN}$$

Gaya geser balok diambil dari nilai minimum dua persamaan berikut :

$$V_u = 1,2.V_D + 0,5.V_L + \frac{2.Mpb}{L'} \dots\dots\dots (3.20a)$$

$$= 1,2. 57,151 + 0,5. 43,656 + \frac{2.262,19}{7,54} = 166,912 \text{ KN}$$

$$V_u = 1,2.V_D + 0,5.V_L + \mu.V_E \dots\dots\dots (3.20b)$$

$$= 1,2. 57,151 + 0,5. 43,656 + 4. 11,552 = 136,617 \text{ KN}$$

Gaya geser rencana balok adalah 136,617 KN

Perhitungan gaya geser rencana selanjutnya dapat dilihat pada lampiran A17 dan A18.

5.3.3 Kuat Geser Nominal Balok Portal

a. Analisis dua dimensi (2D)

Diketahui gaya geser yang bekerja pada balok B2 Portal B adalah

$$V_u = 145,494 \text{ KN (Lampiran A17)}$$

Kontrol perbandingan tinggi terhadap tebal panel (h/tw) pendukung geser

$$h = 0,95 \cdot d = 0,95 \cdot 402,844 = 362,560 \text{ mm}$$

$$\frac{h}{tw} < 1,1 \cdot \sqrt{\frac{k_n E}{fy}} \dots\dots\dots (3.22a)$$

$$\frac{h}{tw} = \frac{362,560}{7,493} = 48,387 < 1,1 \cdot \sqrt{\frac{k_n E}{fy}} = 1,1 \cdot \sqrt{\frac{5,01 \cdot 200000}{250}} = 69,67$$

$$A_w = d \cdot tw = 402,844 \cdot 7,493 = 3018,51 \text{ mm}^2$$

$$\begin{aligned} \phi V_n &= 0,9 \cdot 0,6 \cdot fy \cdot A_w \dots\dots\dots (3.22b) \\ &= 0,9 \cdot 0,6 \cdot 250 \cdot 3018,51 \\ &= 407498,85 \text{ N} = 407,499 \text{ KN} \end{aligned}$$

Rasio tegangan yang terjadi

$$\frac{V_u \cdot k}{\phi V_n} = \frac{145,494}{407,499} = 0,357 < 1,0 \rightarrow \text{AMAN}$$

b. Analisis tiga dimensi (3D)

Diketahui gaya geser yang bekerja pada balok B2 adalah

$$V_u = 136,617 \text{ KN (Lampiran A18)}$$

Kontrol perbandingan tinggi terhadap tebal panel (h/tw) pendukung geser

$$h = 0,95 \cdot d = 0,95 \cdot 402,844 = 362,560 \text{ mm}$$

$$\frac{h}{tw} < 1,1 \cdot \sqrt{\frac{k_n E}{fy}} \dots\dots\dots (3.22a)$$

$$\frac{h}{tw} = \frac{362,560}{7,493} = 48,387 < 1,1 \cdot \sqrt{\frac{k_n E}{fy}} = 1,1 \cdot \sqrt{\frac{5,01 \cdot 200000}{250}} = 69,67$$

$$Aw = d \cdot tw = 402,844 \cdot 7,493 = 3018,51 \text{ mm}^2$$

$$\begin{aligned} \phi Vn &= 0,9 \cdot 0,6 \cdot fy \cdot Aw \dots\dots\dots (3.22b) \\ &= 0,9 \cdot 0,6 \cdot 250 \cdot 3018,51 \\ &= 407498,85 \text{ N} = 407,499 \text{ KN} \end{aligned}$$

Rasio tegangan yang terjadi

$$\frac{Vu,k}{\phi Vn} = \frac{136,617}{407,499} = 0,340 < 1,0$$

Perhitungan kuat geser balok dapat dilihat pada lampiran D9 dan D10

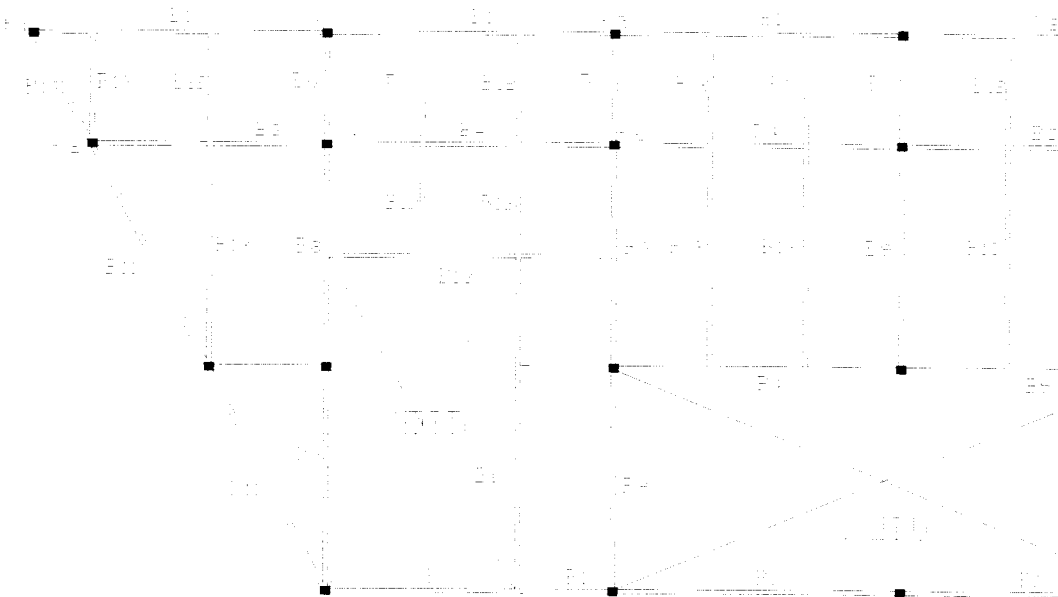

Gambar 5.13 Pola Balok Lantai 1

Tabel 5.2 Rekapitulasi Profil Balok Lantai 1

Analisis 2D		Analisis 3D	
Balok	Profil	Balok	Profil
B1	W18X60	B1	W18X55
B2	W18X60	B2	W18X55
B3	W18X55	B3	W18X55
B4	W18X76	B4	W18X71
B5	W18X86	B5	W18X76
B6	W16X40	B6	W16X31
B7	W16X26	B7	W16X26
B8	W16X40	B8	W16X31
B9	W16X36	B9	W16X36
B10	W14X22	B10	W14X22
B11	W14X26	B11	W14X26
B12	W14X22	B12	W14X22
B13	W14X226	B13	W14X226

Tabel 5.3 Rekapitulasi Profil Balok Lantai 2

Analisis 2D		Analisis 3D	
Balok	Profil	Balok	Profil
B1	W18X55	B1	W18X46
B2	W18X55	B2	W18X46
B3	W18X46	B3	W18X46
B4	W18X55	B4	W18X55
B5	W18X60	B5	W18X55
B6	W16X26	B6	W16X26
B7	W16X26	B7	W16X26
B8	W16X36	B8	W16X26
B9	W16X31	B9	W16X31
B10	W14X22	B10	W14X22
B11	W14X26	B11	W14X26
B12	W14X22	B12	W14X22
B13	W14X26	B13	W14X26

Tabel 5.4 Rekapitulasi Profil Balok Lantai 3

Analisis 2D		Analisis 3D	
Balok	Profil	Balok	Profil
B1	W16X36	B1	W18X46
B2	W16X36	B2	W18X46
B3	W16X26	B3	W18X46
B4	W16X31	B4	W18X55
B5	W16X36	B5	W18X55
B6	W14X22	B6	W16X26
B7	W14X26	B7	W16X26
B10	W14X22	B10	W14X22
B11	W14X26	B11	W14X26
B12	W14X22	B12	W14X22
B13	W14X26	B13	W14X26

5.4 Perencanaan kolom

Perencanaan kolom didasarkan pada prinsip desain *strong column and weak beam*, dimana respon struktur pada kolom ($M_{u,k}$, $N_{u,k}$, dan $V_{u,k}$) terlebih dulu dicari berdasarkan kapasitas maksimum profil balok yang digunakan.

5.4.1 Momen Rencana Kolom ($M_{u,k}$)

Analisis tiga dimensi (3D)

Momen Rencana kolom

Profil balok lantai 1 (B1) adalah W16x26 ($d = 398,526$ mm, $Z_x = 724308,229$ mm³).

$$M_p = Z_x \cdot F_y = 724308,229 \cdot 250 = 181,077 \cdot 10^6 \text{ N.mm} = 181,077 \text{ KN.m}$$

Angka kekakuan (α)

$$\alpha_a = \frac{I_a / L_a}{[(I_b / L_b) + (I_a / L_a)]} \dots\dots\dots (3.24a)$$

$$= \frac{107912}{107912 + 138397} = 0,438$$

$$\alpha_b = \frac{I_b / L_b}{[(I_b / L_b) + (I_a / L_a)]} \dots\dots\dots (3.24b)$$

$$= \frac{138397}{107912 + 138397} = 0,562$$

Perhitungan selanjutnya dapat dilihat pada tabel 5.11 dibawah ini.

Tabel 5.11 Angka Kekakuan

Ting kat	Elemen	Arah X				Arah Y			
		Ib/Lb (mm3)	Ia/La (mm3)	α_{bx}	α_{ax}	Ib/Lb (mm3)	Ia/La (mm3)	α_{by}	α_{ay}
1	Eksterior, ki	107912	138397	0,438	0,562	12332,75	15816,75	0,438	0,562
	Interior, ki	107912	138397	0,438	0,562	12332,75	15816,75	0,438	0,562
	Eksterior, ka	221435	0,000	1,000	0,000	25306,8	0,000	1,000	0,000
	Interior, ka	107912	0,000	1,000	0,000	12332,75	0,000	1,000	0,000
2	Eksterior, ki	138397	138397	0,500	0,500	15816,75	15816,75	0,500	0,500
	Interior	138397	138397	0,500	0,500	15816,75	15816,75	0,500	0,500
	Eksterior, ka	138397	0,000	1,000	0,000	138397	0,000	1,000	0,000
3	Eksterior	138397	0,000	1,000	0,000	138397	0,000	1,000	0,000
	Interior	138397	0,000	1,000	0,000	138397	0,000	1,000	0,000

$$L \text{ balok} = 4\text{m} = 4000 \text{ mm}$$

$$L^1 = 4000 - \frac{462,534}{2} - \frac{462,534}{2} = 3537,466 \text{ mm}$$

$$H \text{ kolom} = 5,13 \text{ m} = 5130 \text{ mm}$$

$$hn = 5130 - \frac{398,526}{2} = 4930,737 \text{ mm}$$

$$Mu,k = \frac{hn}{h} \cdot \alpha \cdot 1,1 \cdot Ry \cdot \left(\frac{L_{bi}}{L^1_{bi}} \cdot M_{bi} + \frac{L_{ba}}{L^1_{ba}} \cdot M_{ba} \right) \dots\dots\dots (3.23a)$$

Maka :

$$M_{u, kb} = \frac{4,93}{5,13} \cdot 0,438 \cdot 1,1 \cdot 1,5 \cdot \left(\frac{4}{3,54} \cdot 199,185 \right) = 156,315 \text{ KN.m}$$

$$M_{u, kb} = 1,2 \cdot 9,102 + 0,5 \cdot 7,841 + 4 \cdot 129,245 = 531,821 \text{ KN.m}$$

Dengan demikian, momen rencana kolom ($M_{u, k}$) bawah pada join lantai 1 (K3) adalah sebesar 156,315 KN.m

Perhitungan momen rencana kolom dapat dilihat pada lampiran B1.

5.4.2 Gaya aksial rencana kolom

Hasil analisis struktur pada kolom K5 lantai 3 adalah (lihat lampiran B2)

$$P_{D, k} = 76,861 \text{ KN}$$

$$P_{L, k} = 54,56 \text{ KN}$$

$$P_{E, k} = 3,235 \text{ KN}$$

Kolom diapit 3 balok yang saling tegak lurus, yaitu satu balok arah x dengan profil W14x26 dan dua balok arah y dengan profil W16x26.

Kapasitas lentur sendi plastis pada kedua ujung balok.

$$P_{u, k} = \left(\frac{M_{pb, ki}}{L'_{ki}} + \frac{M_{pb, ka}}{L'_{ka}} \right) + 1,05 \cdot P_{g, k} \dots\dots\dots (3.26)$$

$$= \left(\frac{2.181,159}{3,54} + \left[2 \cdot \left(\frac{2.199,185}{8,54} \right) \right] \right) + 1,05 \cdot (76,861 + 54,56)$$

$$= 235,814 \text{ KN}$$

Tetapi tidak lebih besar dari :

$$P_{u, k} = 1,2 \cdot P_D + 0,5 \cdot P_L + \mu \cdot P_E = 1,2 \cdot 76,861 + 0,5 \cdot 54,56 + 4 \cdot 3,235$$

$$= 106,573 \text{ KN}$$

Jadi gaya aksial rencana kolom ($P_{U,k}$) terpakai adalah sebesar 106,573 KN

Perhitungan gaya aksial rencana kolom dapat dilihat pada lampiran B2.

5.4.3 Gaya Geser Kolom

Hasil analisis struktur pada kolom lantai 2 (lihat lampiran B3)

$$V_{D,k} = 3,269 \text{ KN}$$

$$V_{L,k} = 3,799 \text{ KN}$$

$$V_{E,k} = 29,536 \text{ KN}$$

$M_{u,k}$ desain = 86,142 KN.m (dari hitungan momen rencana kolom)

$$\begin{aligned} V_{u,k} &= \frac{M_{u,k_{bawah}} + M_{u,k_{atas}}}{h'_k} \dots\dots\dots (3.29) \\ &= \frac{2.86,142}{3,62} \\ &= 47,592 \text{ KN} \end{aligned}$$

Tetapi tidak lebih besar dari :

$$\begin{aligned} V_{u,k} &= 1,2.V_{D,k} + 0,5.V_{L,k} + \mu.V_{E,k} \dots\dots\dots (3.30) \\ &= 1,2. 3,269 + 0,5. 3,799 + 4. 29,536 \\ &= 123,966 \text{ KN} \end{aligned}$$

Jadi gaya geser rencana kolom ($V_{u,k}$) terpakai adalah sebesar 47,592 KN

Perhitungan gaya geser rencana kolom dapat dilihat pada lampiran B3.

5.4.4 Perencanaan Kolom Terhadap Momen Lentur dan Gaya Aksial Rencana

Analisis tiga dimensi (3D)

Kolom Eksterior lantai 2 (K3)

$$M_{u,k x} = 92.103 \text{ KN.m}$$

$$M_{u,k y} = 248.014 \text{ KN.m}$$

$$P_{u,k} = 484.327 \text{ KN}$$

Kekakuan kolom arah x

$$G_A = \frac{\left(\frac{553587796}{5150}\right) + \left(\frac{553587796}{4000}\right)}{\left(\frac{125285659,1}{4000}\right)} = 6,86 \dots\dots\dots (3.20)$$

$$G_B = \frac{\left(\frac{553587796}{5150}\right) + \left(\frac{553587796}{4000}\right)}{\left(\frac{125285659,1}{4000}\right)} = 6,86$$

Dari grafik Johnson dan moreland didapatkan nilai $k_x = 2,25$

Kekakuan kolom arah y

$$G_a = \frac{\left(\frac{553587796}{5150}\right) + \left(\frac{553587796}{4000}\right)}{\left(\frac{2.254733632,5}{9000}\right)} = 1,688 \dots\dots\dots (3.20)$$

$$G_B = \frac{\left(\frac{553587796}{5150}\right) + \left(\frac{553587796}{4000}\right)}{\left(\frac{2.254733632,5}{9000}\right)} = 1,6688$$

Dari grafik Johnson dan moreland didapatkan nilai $k_y = 1,5$

Perhitungan kekakuan kolom dapat dilihat pada tabel 5.14 dibawah ini.

Tabel 5.14 Kekakuan Kolom

Tingkat	Bagian	G	Gx	Kx	Gy	Ky
1	Tepi	Ga	6.86	1.75	1.688	1.4
		Gb	1		1	
	Tengah	Ga	3.935	1.68	3.797	1.65
		Gb	1		1	
2	Tepi	Ga	6.86	2.25	1.688	1.5
		Gb	6.86		1.688	
	Tengah	Ga	3.935	2	3.797	1.9
		Gb	3.935		3.797	
3	Tepi	Ga	8.84	2.95	3.45	1.7
		Gb	6.86		1.688	
	Tengah	Ga	6.68	2.12	4.89	2.1
		Gb	3.935		3.797	

Dicoba Profil W14x99 ($r_y = 94,234$ mm; $r_x = 156,718$ mm ; $S_x = 2572769,05$ mm³ ; $Z_x = 2834962,07$ mm³ ; $A = 18774,156$ mm² ; $X_1 = 219950,5$ Mpa ; $X_2 = 1,89 \cdot 10^{-6}$; $\frac{bf}{2.tf} = 9,34$; $\frac{d}{tw} = 29,2$)

$$\frac{(K.L)_x}{r_x} = \frac{2,25 \times 4000}{156,718} = 57,428$$

$$\frac{(K.L)_y}{r_y} = \frac{1,5 \times 4000}{94,742} = 63,330 \rightarrow \text{yang dipakai}$$

Dari tabel AISC-LRFD hal 6-124 didapatkan nilai $\phi_c.F_{cr}$

$$\phi_c.F_{cr} = 170,58 \text{ Mpa}$$

$$\phi.P_n = \phi_c.F_{cr} \times A = 170,58 \times 18774,156 = 3202,539 \text{ KN}$$

$$L_p = 1,76.r_y.\sqrt{\frac{E}{f_y}} = 1,76.94,234.\sqrt{\frac{2.10^5}{250}} = 4690,998 \text{ mm} > L_b = 4000 \text{ mm}$$

Maka kuat nominal komponen struktur terhadap momen lentur adalah

$$\phi M_{nx} = \phi.Z_x.F_y = 0,9. 2834962,07. 250. 10^{-6} = 637,866 \text{ KN.m}$$

$$\phi M_{ny} = \phi.Z_y.F_y = 0,9. 1369958,55. 250. 10^{-6} = 308,241 \text{ KN.m}$$

Selanjutnya dikontrol terhadap persamaan interaksi kolom aksial dan lentur

$$\frac{P_u}{\phi.P_n} = \frac{484,327}{3202,539} = 0,14 < 0,2$$

Rumus AISC-LRFD

$$\frac{P_u}{2.\phi.P_n} + \left(\frac{M_{ux}}{\phi.M_{nx}} + \frac{M_{uy}}{\phi.M_{ny}} \right) \dots\dots\dots (3.19)$$

$$0,07 + \left(\frac{92.103}{637,866} + \frac{248.014}{308,241} \right) = 0,92 < 1,0 \rightarrow \text{AMAN}$$

Perhitungan perencanaan kolom terhadap lentur dan aksial dapat dilihat pada lampiran E

5.4.5 Perencanaan Kolom Terhadap Geser

Gaya geser ($V_{u,k}$) pada kolom K3 lantai 2 sebesar 119,628 KN

Kontrol rasio tinggi terhadap tebal panel (h/t_w)

$$\frac{d_b}{t_w} = \frac{359,664}{12,319} = 29,196 < 1,1.\sqrt{\frac{k_n E}{f_y}} = 1,1.\sqrt{\frac{5,01.200000}{250}} = 69,67$$

$$A_w = d.t_w = 359,664. 12,319 = 4430,701 \text{ mm}^2$$

$$\begin{aligned}\phi V_n &= 0,9 \cdot 0,6 \cdot f_y \cdot A_w \\ &= 0,9 \cdot 0,6 \cdot 250 \cdot 4430,701 \\ &= 996908 \text{ N} = 996,908 \text{ KN}\end{aligned}$$

Rasio tegangan yang terjadi

$$\frac{V_{u,k}}{\phi V_n} = \frac{119,628}{996,908} = 0,12 < 1,0 \rightarrow \text{AMAN}$$

Perhitungan perencanaan kolom terhadap geser dapat dilihat pada lampiran E3

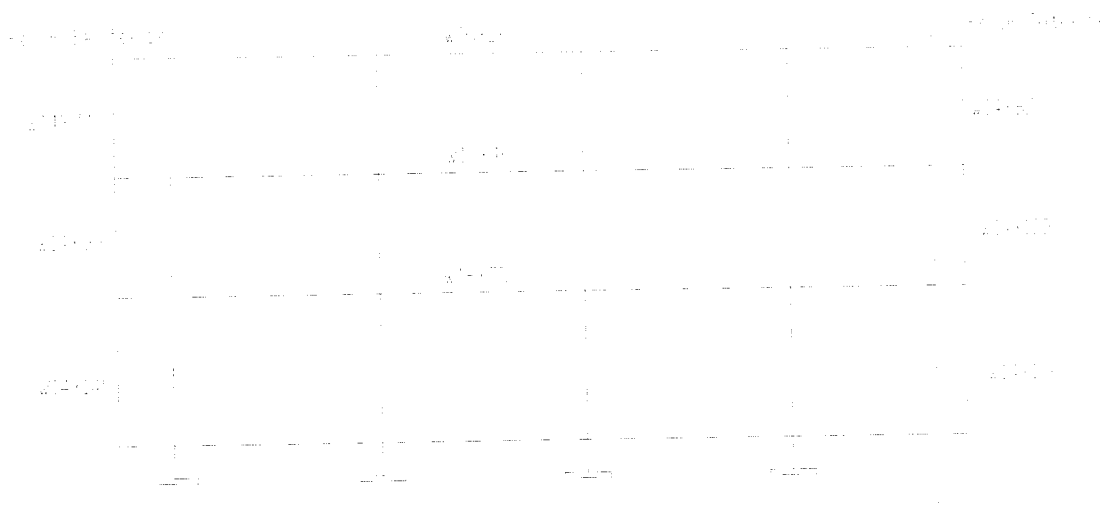

Gambar 5.13 Hasil Desain Kolom dan Balok Portal 1

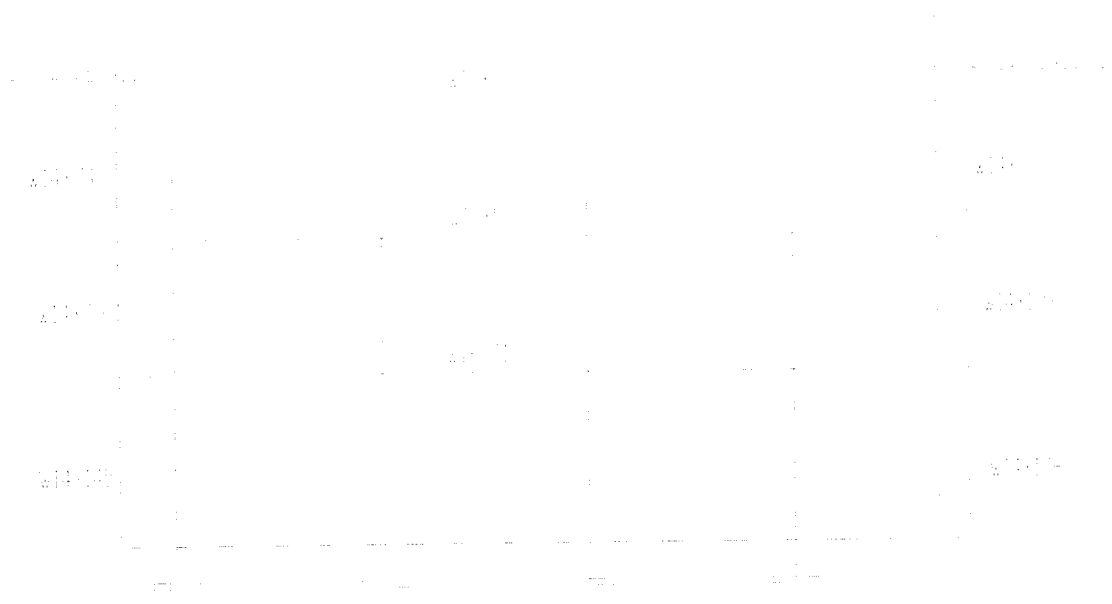

Gambar 5.14 Hasil Desain Kolom dan Balok Portal 2

5.5 Perencanaan Sambungan

5.5.1 Sambungan Balok ke Kolom

Diambil contoh hitungan portal 1 lantai 2 tepi kiri, antara balok B1 dan K3.

Data profil desain yang dipakai

Balok W18X60

$$\begin{aligned}
 A_g &= 11290,3 \text{ mm}^2 & Z_x &= 2015608,872 \text{ mm}^3 \\
 d &= 463,296 \text{ mm} & Z_y &= 337573,518 \text{ mm}^3 \\
 t_w &= 105,41 \text{ mm} & F_y &= 250 \text{ Mpa} \\
 b_f &= 191,897 \text{ mm} & F_u &= 410 \text{ Mpa} \\
 t_f &= 17,653 \text{ mm}
 \end{aligned}$$

Kolom W14X109

$$\begin{aligned}
 A_g &= 20851,571 \text{ mm}^2 & Z_x &= 3146316,288 \text{ mm}^3 \\
 d &= 363,728 \text{ mm} & Z_y &= 1519080,833 \text{ mm}^3 \\
 t_w &= 13,335 \text{ mm} & F_y &= 250 \text{ Mpa} \\
 b_f &= 370,967 \text{ mm} & F_u &= 410 \text{ Mpa} \\
 t_f &= 21,844 \text{ mm} & k &= 39,688 \text{ mm}
 \end{aligned}$$

Prosedur desain

- a. Menentukan beban yang bekerja berdasarkan kapasitas plastis balok

Momen kapasitas balok supaya terjadi strain hardening

$$\begin{aligned}
 M_p &= 1,1 \cdot Z_x \cdot F_y \\
 &= 1,1 \cdot 2015608,872 \cdot 250 \\
 &= 554292439,8 \text{ N.mm} \\
 &= 554,292 \text{ KN.m}
 \end{aligned}$$

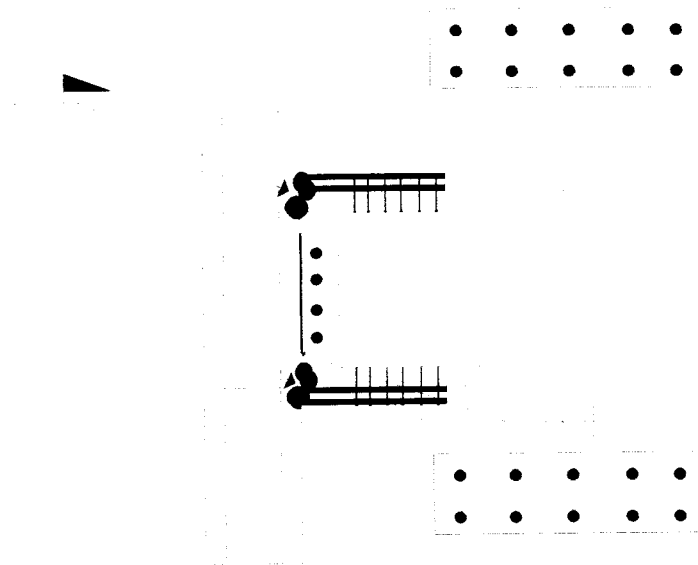

Gambar 5.15 Rencana Sambungan Yang Digunakan

Gaya geser pada lokasi sendi plastis balok B1 hasil dari analisis struktur dapat dilihat pada lampiran A adalah sebagai berikut :

$$V_D = 86,248 \text{ KN}$$

$$V_L = 36,467 \text{ KN}$$

$$V_E = 51,143 \text{ KN}$$

Gaya geser pada sendi plastis balok, merupakan nilai terkecil dari :

$$\begin{aligned}
 V_p &= 1,2.V_D + 0,5.V_L + \frac{2.M_p}{L'} \\
 &= 1,2.86,248 + 0,5.36,467 + \frac{2.554,292}{8,54} = 122,669 \text{ KN}
 \end{aligned}$$

$$V_p = 1,2.V_D + 0,5.V_L + \mu.V_E$$

$$= 1,2. 86,248 + 0,5. 36,467 + 4. 51,143 = 326,303 \text{ KN}$$

Momen pada muka kolom, M_f

$$M_f = M_{pb} + V_p.X = 554,292 + 122,669.0,831 = 656,288 \text{ KN.m}$$

b. Sambungan flange plate ke sayap kolom

Gaya tarik terfaktor, T_u

$$T_u = \frac{M_f}{0,95.d} \dots\dots\dots (3.40)$$

$$= \frac{656,288.10^3}{0,95.463,296} = 1491,119 \text{ KN}$$

Menentukan ukuran flange plate yang menahan tarik dan desak :

Kondisi leleh tarik :

$$T_u \leq \phi.F_y.A_g \dots\dots\dots (3.42)$$

$$A_{g \text{ min}} = \frac{1491,119.10^3}{0,9.250} = 6627,196 \text{ mm}^2 \text{ (menentukan)}$$

Kondisi fraktur :

$$T_u \leq \phi. F_u. A_e \rightarrow A_e = U. A_n \dots\dots\dots (3.43)$$

Untuk $A_n \leq 0,85. A_g$

$U = 1 \rightarrow$ untuk pelat sambung/batang tarik pendek

$$T_u \leq \phi. F_u. U. 0,85. A_g$$

$$A_{g \text{ min}} = \frac{1491,119.10^3}{0,75.410.1.0,85} = 5704,903 \text{ mm}^2$$

Jika digunakan lebar flange plate, $b_{pl} = 165 \text{ mm}$

$$\text{Maka tebal flange plate, } t_{pl} = \frac{6627,196}{165} = 40,165 \text{ mm} \approx 45 \text{ mm}$$

Menentukan jumlah baut yang diperlukan untuk menstabilkan gaya tarik dan tekan pada bagian atas dan bawah balok :

Kuat geser satu baut A₃₂₅-X diameter $\frac{7}{8}$ in

$$\begin{aligned} \phi R_n &= \phi \cdot (0,6 \cdot F_u^b) \cdot m \cdot A_b \dots\dots\dots (3.44) \\ &= 0,75 \cdot (0,6 \cdot 838) \cdot 1 \cdot 387,96 = 146295,158 \text{ N} = 146,295 \text{ KN} \end{aligned}$$

Kebutuhan baut minimal untuk menahan geser

$$n_{\min} = \frac{T_u}{\phi R_n} = \frac{1491,119}{146,295} = 10,193 \rightarrow 12 \text{ buah} \dots\dots\dots (3.45)$$

Kuat tumpu sayap balok

$$\begin{aligned} \phi R_n &= \phi \cdot 2,4 \cdot F_u \cdot d_b \cdot t_p \dots\dots\dots (3.46) \\ &= 0,75 \cdot 2,4 \cdot 410 \cdot 25 \cdot 17,653 = 325697,85 \text{ N} \\ &= 325,698 \text{ KN} > 146,295 \text{ KN} \end{aligned}$$

Menentukan ukuran plat geser, jumlah baut dan panjang las :

$$\begin{aligned} V_f &= \frac{2 \cdot M_f}{L_n} + V_g \dots\dots\dots (3.50) \\ &= \frac{2.656,288}{8.54} + 1,2.86,248 + 0,5.36,467 = 298,58 \text{ KN} \end{aligned}$$

Apabila digunakan baut dengan diameter $\frac{3}{4}$ in

$$\begin{aligned} \phi R_n &= \phi \cdot (0,6 \cdot F_u^b) \cdot m \cdot A_b \dots\dots\dots (3.44) \\ &= 0,75 \cdot (0,6 \cdot 838) \cdot 1 \cdot 285,023 = 107482,157 \text{ N} = 107,482 \text{ KN} \end{aligned}$$

$$\text{Jumlah baut } n = \frac{V_f}{\phi R_n} = \frac{298,58}{107,482} = 2,78 \rightarrow 4 \text{ buah} \dots\dots\dots (3.52)$$

Dicoba plat $\frac{3}{8}$ X 11,5

Kontrol geser leleh pada plat

$$\begin{aligned} \phi R_n &= \phi \cdot (0,6 \cdot F_y) \cdot A_g \dots\dots\dots (3.53) \\ &= 0,9 \cdot (0,6 \cdot 250) \cdot 2782,253 = 375604,088 \text{ N} \\ &= 375,604 \text{ KN} > V_f = 298,58 \text{ KN} \rightarrow Ok \end{aligned}$$

Kontrol geser fraktur pada plat :

$$\begin{aligned} \phi R_n &= \phi \cdot (0,6 \cdot F_u) \cdot A_n \dots\dots\dots (3.54) \\ &= 0,75 \cdot (0,6 \cdot 410) \cdot 1995,964 = 368255,312 \text{ N} \\ &= 368,255 \text{ KN} > V_f = 298,58 \text{ KN} \rightarrow Ok \end{aligned}$$

Menentukan panjang las fillet pada plat geser

$$a_{\max} = t_{pl} - \frac{1}{16} = \frac{3}{8} - \frac{1}{16} = \frac{5}{16} \text{ in}$$

$$a_{\min} = \frac{3}{16} \text{ in}$$

$$a_{\text{pakai}} = \frac{1}{4} \text{ in}$$

$$t_e = 0,707 \cdot a = 0,707 \cdot 0,25 = 0,177 \text{ in} = 5 \text{ mm}$$

Kekuatan las terhadap geser

$$\begin{aligned} \phi R_{nw} &= \phi \cdot (0,6 \cdot f_uw) \cdot t_e \dots\dots\dots (3.55) \\ &= 0,75 \cdot (0,6 \cdot 485) \cdot 5 = 1091,25 \text{ N/mm (menentukan)} \end{aligned}$$

Kekuatan las terhadap geser fraktur dari logam dasar

$$\begin{aligned} \phi R_{nw} &= \phi \cdot (0,6 \cdot f_u) \cdot t_{pl} \dots\dots\dots (3.56) \\ &= 0,75 \cdot (0,6 \cdot 410) \cdot 10 = 1845 \text{ N/mm} \end{aligned}$$

Panjang las yang dibutuhkan

$$\begin{aligned}
 P_{\text{las}} &= \frac{V_f}{\phi R_{nw}} \dots\dots\dots (3.57) \\
 &= \frac{298,58 \cdot 10^3}{1091,25} = 273,613 \text{ mm} \rightarrow \text{pakai 275 mm}
 \end{aligned}$$

5.5.3 Perencanaan Sambungan Kolom dengan Kolom

Diketahui profil kolom K3 lantai 1 adalah W14X159 dan lantai 2 adalah W14X99. $M_{u,k} = 698,745 \text{ KN.m}$ dan $P_{u,k} = 657,569 \text{ KN}$

Kolom W14X159

$A_g = 30128,97 \text{ mm}^2$	$Z_x = 4703087,368 \text{ mm}^3$
$d = 381 \text{ mm}$	$Z_y = 2392511,344 \text{ mm}^3$
$t_w = 18,923 \text{ mm}$	$F_y = 250 \text{ Mpa}$
$b_f = 396,24 \text{ mm}$	$F_u = 410 \text{ Mpa}$
$t_f = 30,226 \text{ mm}$	$k = 46,736 \text{ mm}$

Gaya pada sayap kolom

$$\begin{aligned}
 P_{u_f} &= \frac{M_{u,k}}{0,95 \cdot d} \dots\dots\dots (3.58) \\
 &= \frac{698,745 \cdot 10^3}{0,95 \cdot 363,728} = 2022 \text{ KN}
 \end{aligned}$$

a. Sambungan pada sayap

Kuat geser satu baut

Apabila digunakan baut tipe A325 dengan diameter $\frac{3}{4}$ in

$$\begin{aligned} \phi R_n &= \phi \cdot (0,6 \cdot F_u^b) \cdot m \cdot A_b \dots\dots\dots (3.44) \\ &= 0,75 \cdot (0,6 \cdot 838) \cdot 1 \cdot 285,023 = 107482,157 \text{ N} = 107,482 \text{ KN} \end{aligned}$$

Jumlah baut yang diperlukan

$$\begin{aligned} n_{\text{perlu}} &= \frac{P_{u_f}}{2 \cdot \phi \cdot R_n} \dots\dots\dots (3.59) \\ &= \frac{2022}{2 \cdot 107,482} = 9,4 \approx 10 \text{ buah} \end{aligned}$$

Dicoba pelat lebar 10,5 in

Luas penampang bruto *flange plate*

$$\begin{aligned} A_g &= \frac{P_{u_f}}{0,9 \cdot F_y} \dots\dots\dots (3.62) \\ &= \frac{2022 \cdot 10^3}{0,9 \cdot 250} = 8986,66 \text{ mm}^2 \\ t_{\text{min}} &= \frac{A_g}{l} = \frac{8986,66}{10,5 \cdot 25,4} = 33,696 \text{ mm} \end{aligned}$$

Kontrol kekuatan pelat sambung

$$\begin{aligned} \phi R_n &= \phi \cdot f_u \cdot A_{nt} > \frac{P_{u_f}}{2} \dots\dots\dots (3.63) \\ A_{gt} &= \frac{3}{4} \cdot 10,5 = 7,875 \text{ in}^2 = 5080,635 \text{ mm}^2 \\ A_{nt} &= (10,5 - 2(\frac{3}{4} + \frac{1}{6})) \cdot \frac{3}{4} = 6,5 \text{ in}^2 = 4193,54 \text{ mm}^2 \\ 0,85 \cdot A_{gt} &= 0,85 \cdot 5080,635 = 4318,54 \text{ mm}^2 > A_{nt} = 4193,54 \text{ mm}^2 \end{aligned}$$

$$\phi R_n = \phi \cdot f_u \cdot A_n > \frac{P_u}{2} \dots\dots\dots (3.63)$$

$$\phi R_n = 0,75 \cdot 410 \cdot 4193,54 = 1289,514 \text{ KN} > \frac{2022}{2} = 1011 \text{ KN}$$

AMAN

b. Sambungan pada badan

Gaya pada badan kolom

$$P_{uw} = \frac{P_u \cdot k \cdot A_w}{A} \dots\dots\dots (3.66)$$

$$= \frac{657,569 \cdot 30128,97}{6065,73} = 2266,2 \text{ KN}$$

Kuat geser satu baut

Apabila digunakan baut tipe A325 dengan diameter $\frac{3}{4}$ in

$$\phi R_n = \phi \cdot (0,6 \cdot F_u^b) \cdot m \cdot A_b \dots\dots\dots (3.44)$$

$$= 0,75 \cdot (0,6 \cdot 838) \cdot 1 \cdot 285,023 = 107482,157 \text{ N} = 107,482 \text{ KN}$$

Jumlah baut yang diperlukan

$$n_{\text{perlu}} = \frac{P_u}{2 \cdot \phi \cdot R_n} \dots\dots\dots (3.59)$$

$$= \frac{2266,2}{2 \cdot 107,482} = 10,2 \approx 12 \text{ buah}$$

Dicoba pelat lebar 10,5 in

Luas penampang bruto *flange plate*

$$A_g = \frac{P_u_f}{0,9.F_y} \dots\dots\dots (3.62)$$

$$= \frac{2266,2 \cdot 10^3}{0,9 \cdot 250} = 10072 \text{ mm}^2$$

$$t_{\min} = \frac{A_g}{l} = \frac{10072}{10,5 \cdot 25,4} = 37,766 \text{ mm}$$

Kontrol kekuatan pelat sambung

$$\phi R_n = \phi \cdot f_u \cdot A_n > \frac{P_u_f}{2} \dots\dots\dots (3.63)$$

$$A_{gt} = \frac{3}{4} \cdot 10,5 = 7,875 \text{ in}^2 = 5080,635 \text{ mm}^2$$

$$A_n = (10,5 - 2(\frac{3}{4} + \frac{1}{6})) \cdot \frac{3}{4} = 6,5 \text{ in}^2 = 4193,54 \text{ mm}^2$$

$$0,85 \cdot A_{gt} = 0,85 \cdot 5080,635 = 4318,54 \text{ mm}^2 > A_n = 4193,54 \text{ mm}^2$$

$$\phi R_n = \phi \cdot f_u \cdot A_n > \frac{P_u_f}{2} \dots\dots\dots (3.63)$$

$$\phi R_n = 0,75 \cdot 410 \cdot 4193,54 = 1289,514 \text{ KN} > \frac{2266,2}{2} = 1133,1 \text{ KN}$$

AMAN

5.5.4 Perencanaan Pelat Dasar Kolom

Momen dan gaya aksial yang bekerja

$$M_{u,k x} = 615,878 \text{ KN.m (Lampiran B1)}$$

$$M_{u,k y} = 173,612 \text{ KN.m (Lampiran B1)}$$

$$P_{u,k} = 704,969 \text{ KN (Lampiran B2)}$$

Digunakan Profil kolom W14X159 dengan data sebagai berikut :

$$\begin{array}{ll}
A_g = 30128,97 \text{ mm}^2 & Z_x = 4703087,368 \text{ mm}^3 \\
d = 381 \text{ mm} & Z_y = 2392511,344 \text{ mm}^3 \\
t_w = 18,923 \text{ mm} & F_y = 250 \text{ Mpa} \\
b_f = 396,24 \text{ mm} & F_u = 410 \text{ Mpa} \\
t_f = 30,226 \text{ mm} & k = 46,736 \text{ mm}
\end{array}$$

Eksentrisitas akibat momen

$$e_y = \frac{M_u, k_x}{P_u, k} = \frac{615,878}{704,969} = 0,874 \text{ m}$$

$$e_y = \frac{M_u, k_y}{P_u, k} = \frac{173,612}{704,969} = 0,246 \text{ m}$$

diasumsikan $e > L/6$, akibat e terjadi pembesaran gaya aksial, maka diberi sayap tambahan = 101,9 mm (menggunakan profil C12X45).

Kesetimbangan momen pada pusat gaya aksial T :

$$P_u, k \left(\frac{d_c}{2} + \frac{b_f c_a}{2} \right) + M_u, k_x + M_u, k_y = R \left(d_c + b_f c_a - \frac{t_f}{2} \right) \dots(3.77)$$

$$T = \frac{704,969 \left(\frac{0,381}{2} + \frac{0,396}{2} \right) + 615,878 + 173,612}{0,381 + 0,396 - \frac{0,0302}{2}}$$

$$= 1395,68 \text{ KN}$$

Diasumsikan luas bidang tekan efektif penumpu akibat momen yang bekerja adalah (X.B), sehingga gaya tekan yang terjadi harus memenuhi :

$$\phi P_p \geq P_u \dots\dots\dots (3.78)$$

$$\phi(0,5.F_p . X.B) = P_u$$

$$(X.B) = \frac{2.P_u}{\phi.F_p} = \frac{2.1395,68.1000}{\phi.0,5.25} = 372181,33 \text{ mm}^2$$

Coba B = 0,7 m, maka panjang bidang tekan

$$X = \frac{X.B}{0,7m} = \frac{372181,33}{700} = 531,69 \text{ mm}$$

$$\text{Jarak dari pusat flens ke ujung pelat} = 1/3.X \dots\dots\dots (3.79)$$

$$= 1/3. 531,69 = 177,23 \text{ mm}$$

Panjang pelat dasar yang dibutuhkan

$$L = (2.X) + (dc - tf) \dots\dots\dots (3.80)$$

$$= (2.177,23) + (381-30,226) = 705,23 \text{ mm} = 0,705 \text{ m}$$

Diambil L = 710 mm = 0,71 m

Dipakai B = 0,7 m dan L = 0,71 m

$$m = \frac{L - 0,95.dc}{2} \dots\dots\dots (3.81)$$

$$= \frac{0,71 - 0,95.0,381}{2} = 0,17 \text{ m}$$

$$n = \frac{B - 0,8.b_f}{2} \dots\dots\dots (3.82)$$

$$= \frac{0,7 - 0,8.0,396}{2} = 0,19 \text{ m}$$

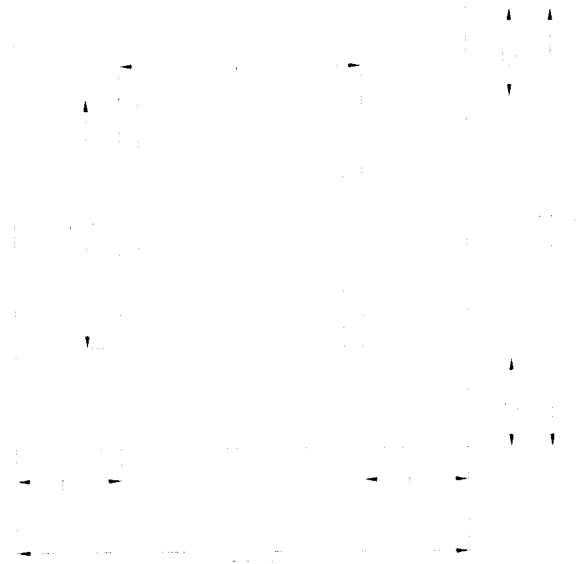

Gambar 5.17 Desain Pelat Dasar Kolom

Tegangan pada ujung pelat :

$$f_p = \frac{Pu}{B.L} \pm \frac{Mu, kx}{\frac{1}{6}B.L^2} \pm \frac{Mu, ky}{\frac{1}{6}B^2.L} < F_p \text{ (fy dalam Mpa) (3.83)}$$

$$f_p \text{ max} = \frac{1395,68}{0,7 \cdot 0,71} + \frac{615,878}{\frac{1}{6}0,7 \cdot 0,71^2} + \frac{173,612}{\frac{1}{6}0,7^2 \cdot 0,71} = 14884,66 \text{ KN/m}^2$$

$$f_p \text{ min} = \frac{1395,68}{0,7 \cdot 0,71} - \frac{615,878}{\frac{1}{6}0,7 \cdot 0,71^2} - \frac{173,612}{\frac{1}{6}0,7^2 \cdot 0,71} = 154,23 \text{ KN/m}^2$$

Cek kapasitas penumpu (pedestal)

$$\phi P_p \geq P_u \text{ (3.84)}$$

$$\phi P_p = \phi_c \cdot F_p \cdot A \text{ (3.85)}$$

$$= 0,6 \cdot 0,5 \cdot 25 \cdot 497000 = 3727500 \text{ N} = 3727,5 \text{ KN} > 1395,68$$

Perencanaan baut angkur arah y yang menahan Mu, kx

$$T = \frac{Mu, kx}{d} \dots\dots\dots (3.92)$$

$$= \frac{615,878}{0,381 + 0,102} = 1275,11 \text{ KN}$$

Kapasitas tarik satu angkur (ϕTn), digunakan baut angkur A325 D = 1 in

$$\phi Tn = \phi \cdot 0,75 \cdot fu \cdot Ab \dots\dots\dots (3.93)$$

$$= \phi \cdot 0,75 \cdot 838 \cdot 506,707 = 191079,39 \text{ N} = 191,08 \text{ KN}$$

Jumlah angkur minimum yang diperlukan

$$n = \frac{T}{\phi Tn} \dots\dots\dots (3.94)$$

$$= \frac{1275,11}{191,08} = 6,67 \approx 8$$

Perencanaan baut angkur arah x yang menahan Mu, ky

$$T = \frac{Mu, ky}{d} \dots\dots\dots (3.92)$$

$$= \frac{173,612}{0,381 + 0,102} = 559,45 \text{ KN}$$

Kapasitas tarik satu angkur (ϕTn), digunakan baut angkur A325 D = 1 in

$$\phi Tn = \phi \cdot 0,75 \cdot fu \cdot Ab \dots\dots\dots (3.93)$$

$$= \phi \cdot 0,75 \cdot 838 \cdot 506,707 = 191079,39 \text{ N} = 191,08 \text{ KN}$$

Jumlah angkur minimum yang diperlukan

$$n = \frac{T}{\phi Tn} \dots\dots\dots (3.94)$$

$$= \frac{559,45}{191,08} = 2,9 \approx 4$$

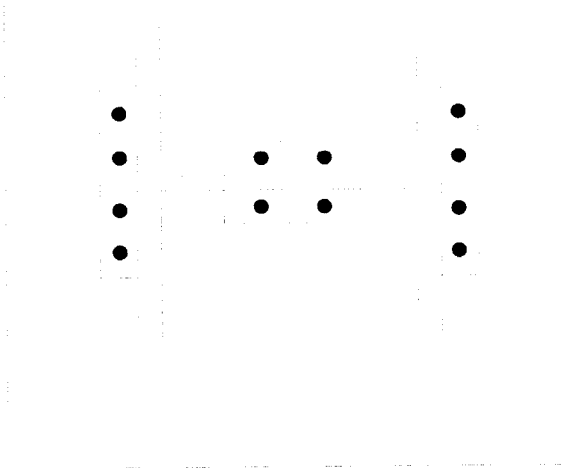

Gambar 5.18 Desain Pelat Dasar Kolom

5.5.5 Perencanaan Pedestal (Kaki Kolom)

Dimensi pelat dasar kolom, $L = 710$ mm dan $B = 700$ mm

Dimensi pedestal, $b = 800$ mm dan $h = 950$ mm

Tulangan longitudinal

Rasio tulangan pakai, $\rho = 1\%$

$$A_{st} = 0,01 \cdot A_g \dots\dots\dots (3.99)$$

$$= 0,01 \cdot 800 \cdot 950 = 7600 \text{ mm}^2$$

Digunakan $D_{25} \rightarrow A_{\phi 25} = 490,874 \text{ mm}^2$

Jumlah tulangan longitudinal

$$n = \frac{Ast}{A_{\phi 22}} \dots\dots\dots (3.100)$$

$$= \frac{7600}{490,874} = 15,5 \approx 16 \text{ buah}$$

Dipakai tulangan 16D₂₅ dipasang merata pada pedestal

Tulangan sengkang

V_{u,k} pakai = 184,367 KN (lihat lampiran B3)

$$V_s = \frac{Vu, k_{pakai}}{\phi} \dots\dots\dots (3.101)$$

$$= \frac{184,367}{0,6} = 307,28 \text{ KN}$$

Dipakai tulangan sengkang P₁₀ → A_{φ10} = 78,54 mm²

Jarak antar tulangan

$$S = \frac{Av \cdot fy \cdot d}{V_s} \dots\dots\dots (3.102)$$

$$= \frac{1,5 \cdot 78,54 \cdot 400 \cdot 1000}{307,28 \cdot 1000} = 206,72 \text{ mm}$$

Dipakai sengkang 3 kaki, 1,5P₁₀ – 200

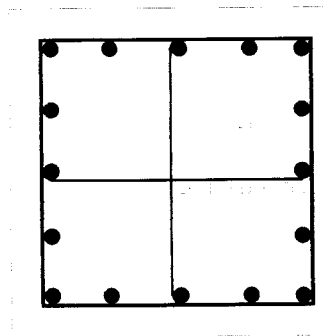

Gambar 5.19 Desain Pedestal (kaki kolom)

BAB VI KESIMPULAN



BAB VI

HASIL DAN PEMBAHASAN

Hasil dari desain yang telah dilakukan didapatkan bahwa antara Analisis dua dimensi (2D) dan tiga dimensi (3D) terdapat perbedaan, gaya-gaya dalam yang terjadi pada struktur berbeda sehingga profil balok maupun kolom yang didapatkan juga berbeda. Pembahasan yang akan dilakukan meliputi hasil dan perbandingan momen balok, momen kolom, gaya aksial kolom, gaya geser balok, gaya geser kolom dan berat struktur portal.

6.1 Hasil Analisis Momen dan Gaya Geser Balok

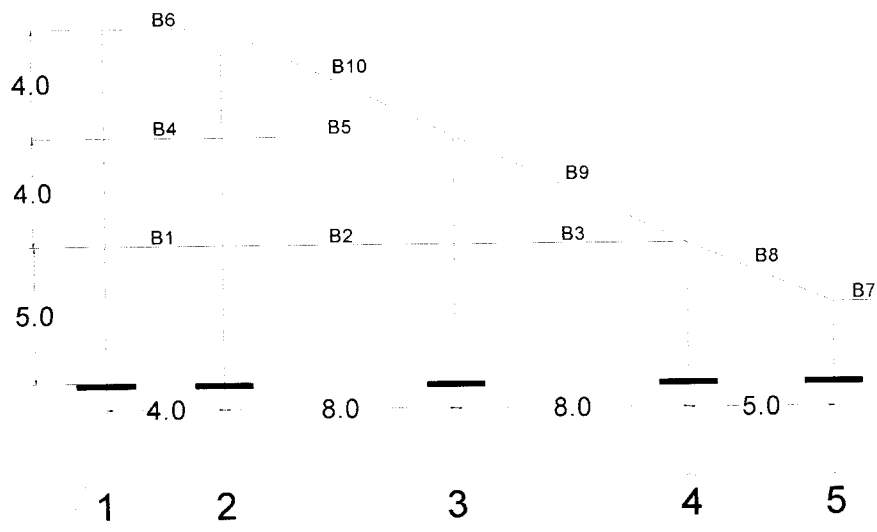

Gambar 6.1 Struktur Portal Arah Melintang

○ **Tabel Momen (Mu) dan Gaya Gaya Geser (Vu) Balok Portal As B**

Balok	2D		3D		Rasio 2D/3D	
	Mu (KN.m)	Vu (KN)	Mu (KN.m)	Vu (KN)	Mu (KN.m)	Vu (KN)
B1	140.956	150.792	135.514	138.123	1.04	1.09
B2	225.057	145.494	212.907	136.617	1.06	1.06
B3	161.419	89.716	138.914	68.09	1.16	1.32
B4	133.365	63.488	123.134	46.707	1.08	1.36
B5	101.819	55.738	93.526	47.396	1.09	1.18
B6	94.153	42.023	89.741	34.396	1.05	1.22
B7	145.576	53.502	135.244	51.308	1.08	1.04
B8	269.596	204.289	250.365	199.536	1.08	1.02
B9	288.84	93.194	249.776	73.393	1.16	1.27
B10	240.157	97.291	226.904	87.678	1.06	1.11

○ **Tabel Momen (Mu) dan Gaya Gaya Geser (Vu) Balok Portal As 1**

Balok	2D		3D		Rasio 2D/3D	
	Mu (KN.m)	Vu (KN)	Mu (KN.m)	Vu (KN)	Mu (KN.m)	Vu (KN)
B1	433.001	215.542	352.106	179.711	1.23	1.20
B2	293.521	249.926	263.557	189.379	1.11	1.32
B3	437.478	206.329	365.576	168.125	1.20	1.23
B4	382.454	204.841	321.557	167.778	1.19	1.22
B5	393.382	201.195	299.821	171.649	1.31	1.17
B6	369.861	206.912	296.821	151.895	1.25	1.36
B7	208.737	107.213	158.91	87.725	1.31	1.22
B8	193.859	90.507	155.258	74.938	1.25	1.21
B9	193.393	90.423	187.843	70.57	1.03	1.28

1. Grafik Hasil Analisis Momen Perlu (Mu) Balok

○ Balok Portal As B (Arah X)

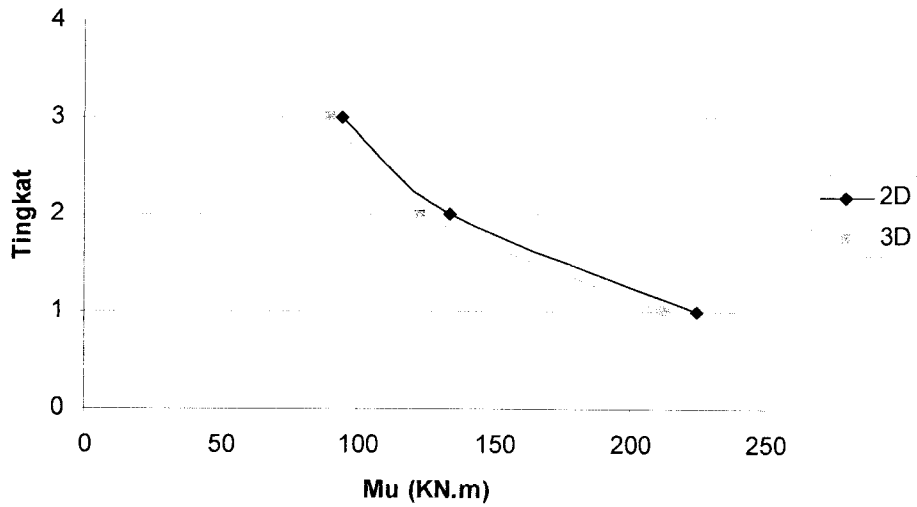

Gambar 6.2 Momen Balok (Mu) Portal As B

○ Balok Portal As 1 (Arah Y)

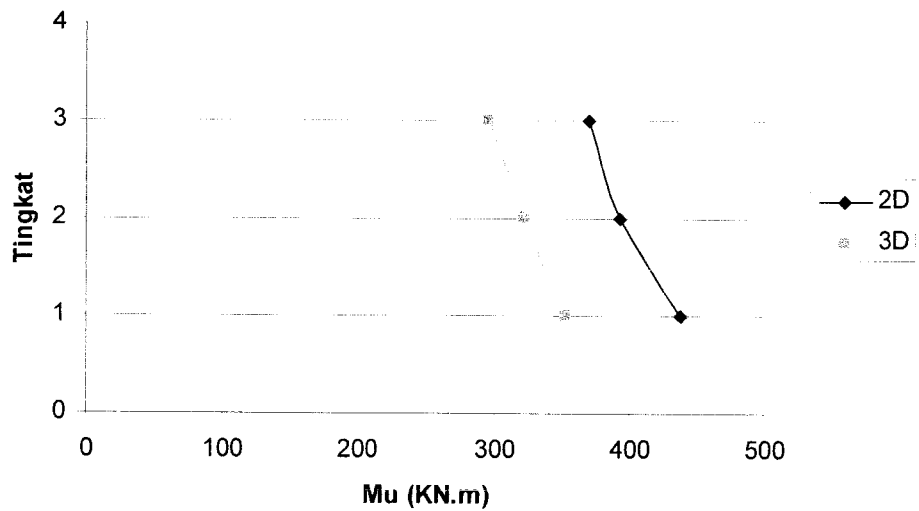

Gambar 6.3 Momen Balok (Mu) Portal As 1 Analisis 2D dan 3D

2. Grafik Hasil Analisis Gaya Geser (V_u) Balok

○ Balok Portal As B (Arah X)

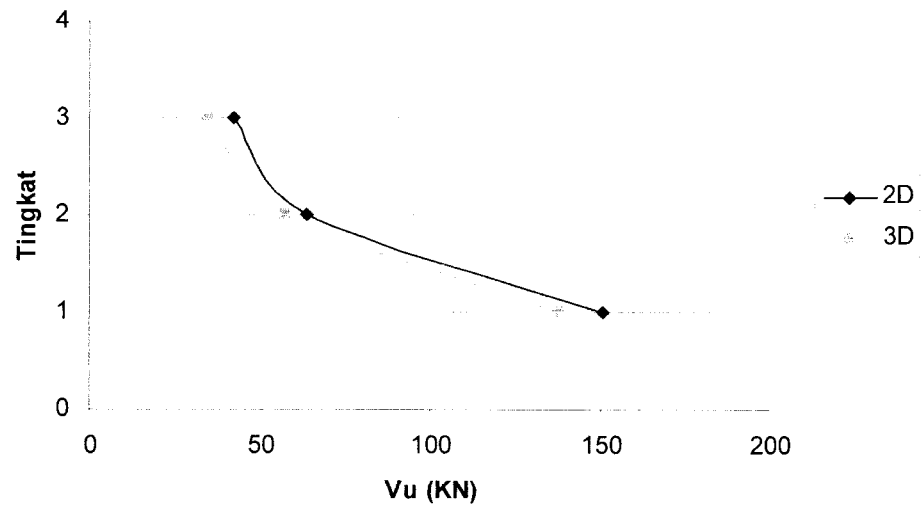

Gambar 6.4 Gaya Geser (V_u) Portal As B Analisis 2D dan 3D

○ Balok Portal As 1 (Arah Y)

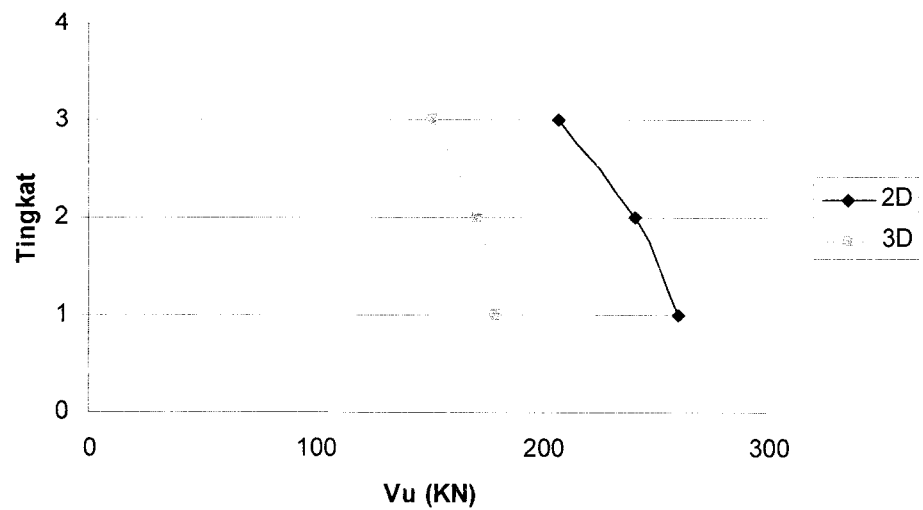

Gambar 6.5 Gaya Geser (V_u) Portal As 1 Analisis 2D dan 3D

6.2 Hasil Analisis Momen, Gaya Aksial dan Gaya Geser Kolom

○ Tabel Momen (Mu), Gaya Aksial (Pu) dan Gaya Geser (Vu) Kolom K3

Tingkat	2D		3D		Rasio 2D/3D	
	Mux (KN.m)	Muy (KN.m)	Mux (KN.m)	Muy (KN.m)	Mux (KN.m)	Muy (KN.m)
1	698.745	221.225	615.878	173.612	1.135	1.274
2	440.755	121.077	345.014	92.103	1.277	1.315
3	261.718	76.013	193.419	55.619	1.353	1.367

Tingkat	2D	3D	Rasio 2D/3D
	Pu (KN)	Pu (KN)	Pu (KN)
1	841.239	704.969	1.19
2	501.914	436.327	1.15
3	174.64	161.92	1.08

Tingkat	2D		3D		Rasio 2D/3D	
	Vux (KN)	Vuy (KN)	Vux (KN)	Vuy (KN)	Vux (KN)	Vuy (KN)
1	319.747	80.178	284.367	66.095	1.124	1.213
2	126.297	31.168	119.628	23.02	1.056	1.354
3	73.245	30.729	64.726	26.55	1.132	1.157

1. Grafik Hasil Analisis Momen Perlu (Mu) Kolom

○ Kolom K3 Arah X (Mux)

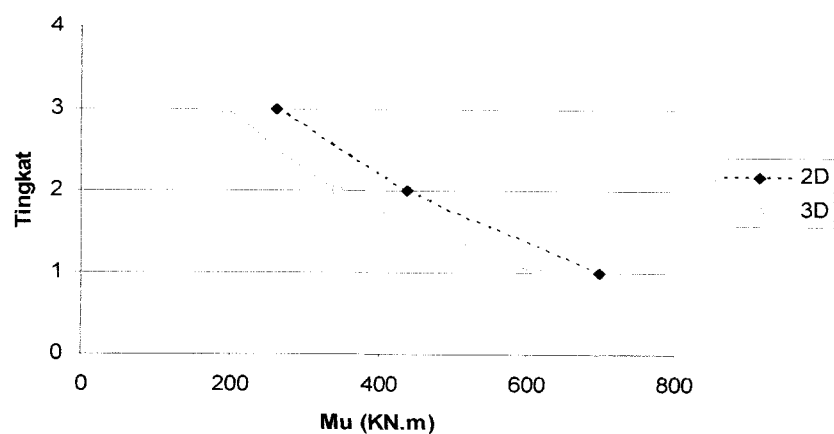

Gambar 6.6 Momen (Mux) Kolom K3

○ Kolom K3 Arah Y (M_{uy})

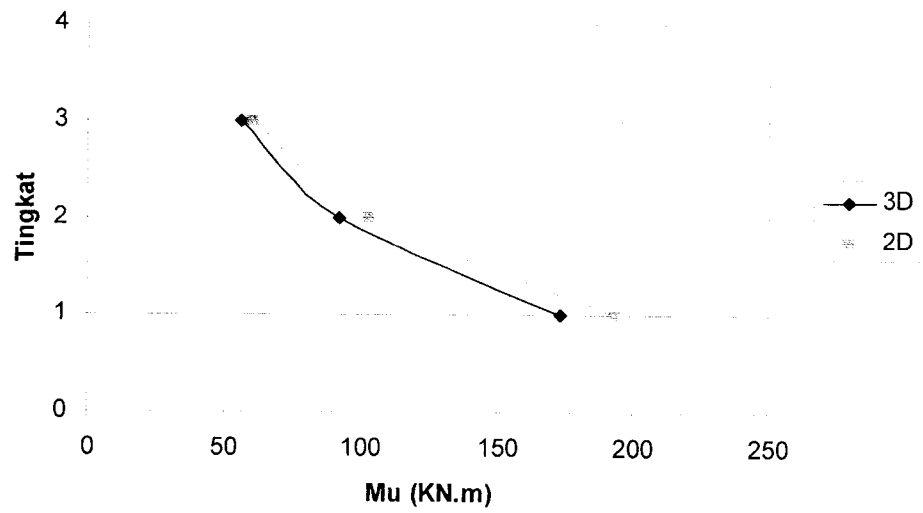

Gambar 6.7 Momen (M_{uy}) Kolom K3

2. Grafik Hasil Analisis Gaya Aksial (P_u) Kolom

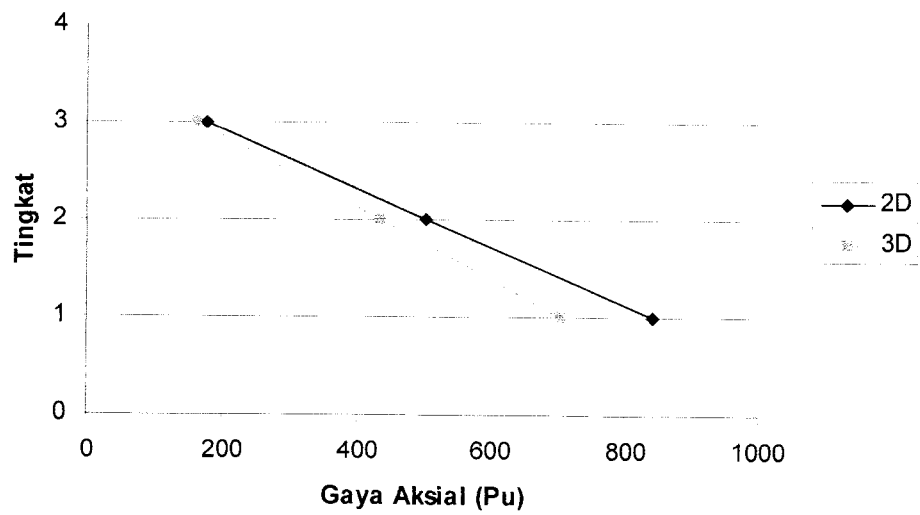

Gambar 6.8 Gaya Aksial (P_u) Kolom K3

3. Grafik Hasil Analisis Gaya Geser (V_u) Kolom

○ Kolom K3 Arah X (V_{ux})

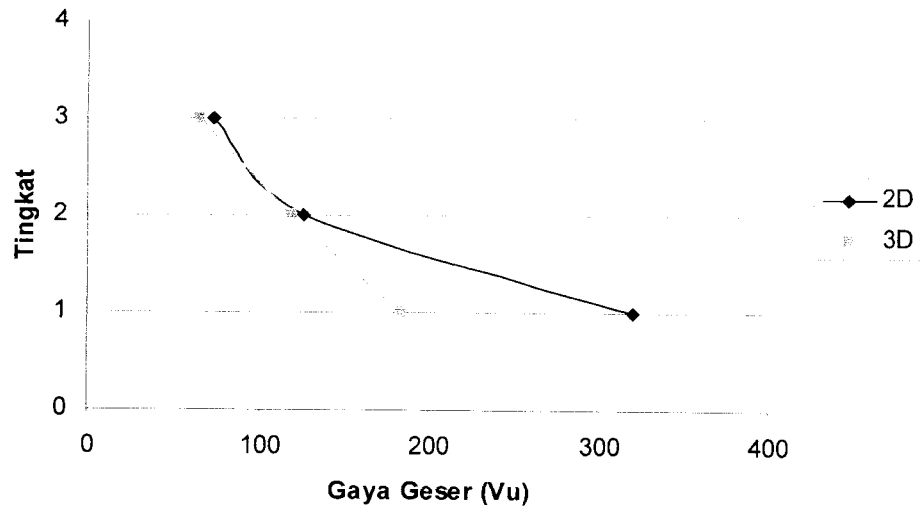

Gambar 6.9 Gaya Geser (V_{ux}) Kolom K3

○ Kolom K3 Arah Y (V_{uy})

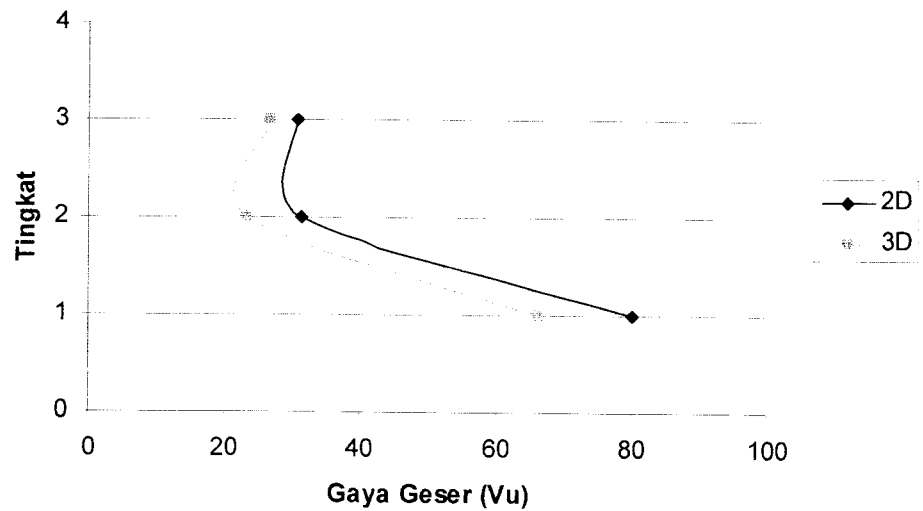

Gambar 6.10 Gaya Geser (V_{uy}) Kolom K3

6.3 Rasio 2D/3D Momen (μ) dan Gaya Geser (V_u) Balok

1. Rasio 2D/3D Momen (μ) Balok

- Balok Portal As B (Arah X)

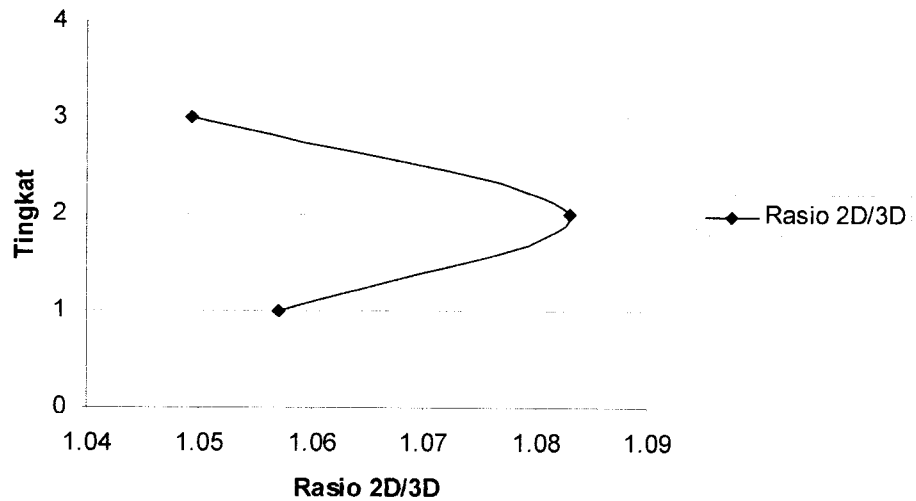

Gambar 6.11 Rasio Momen (μ) 2D/3D Portal As B

- Balok Portal As 1 (Arah Y)

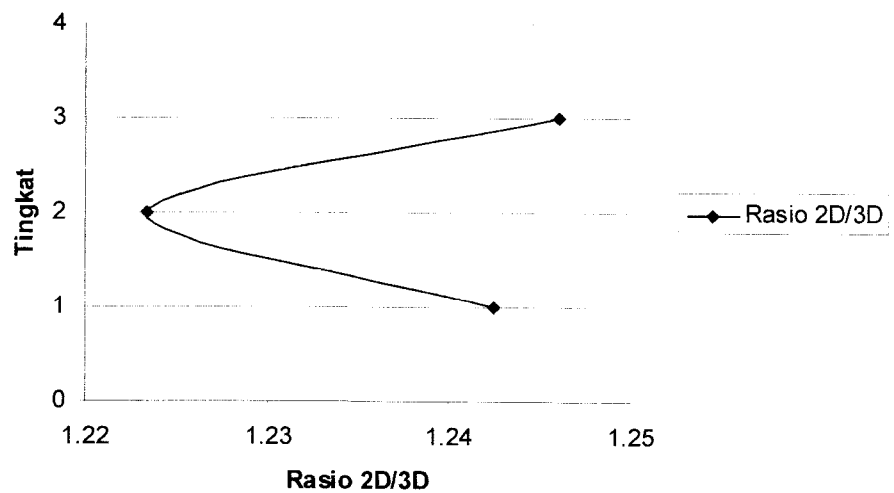

Gambar 6.12 Rasio Momen (μ) 2D/3D Portal As 1

2. Grafik Rasio Hasil Analisis Gaya Geser (V_u) Balok

- Balok Portal As B (Arah X)

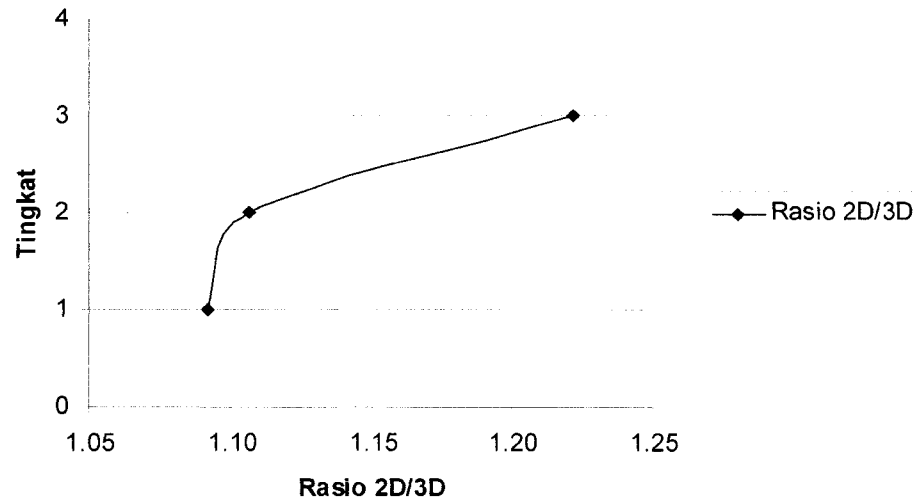

Gambar 6.13 Rasio Gaya Geser (V_u) 2D/3D Portal As B

- Balok Portal As 1 (Arah Y)

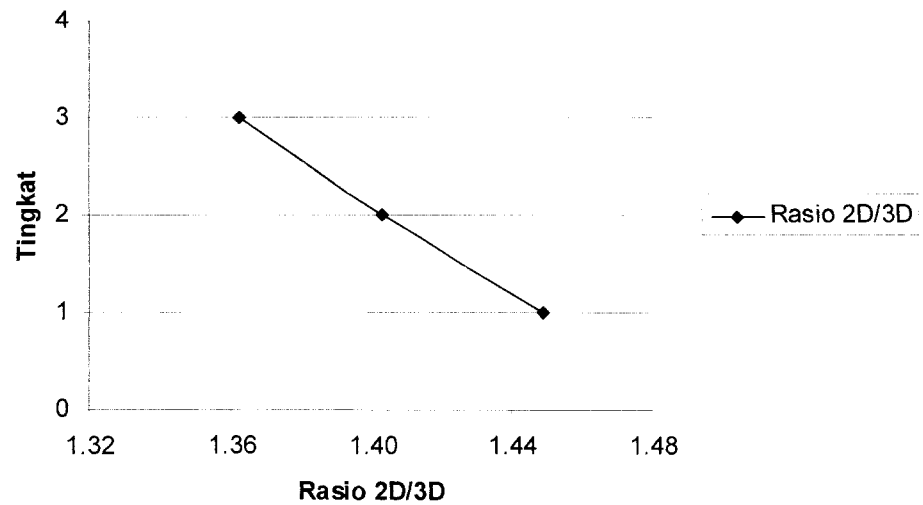

Gambar 6.14 Rasio Gaya Geser (V_u) 2D/3D Portal As 1

6.3 Rasio 2D/3D Momen (M_u) dan Gaya Geser (V_u) Kolom

1. Grafik Rasio Hasil Analisis Momen (M_u) Kolom

- Kolom K3 Arah X (M_{ux})

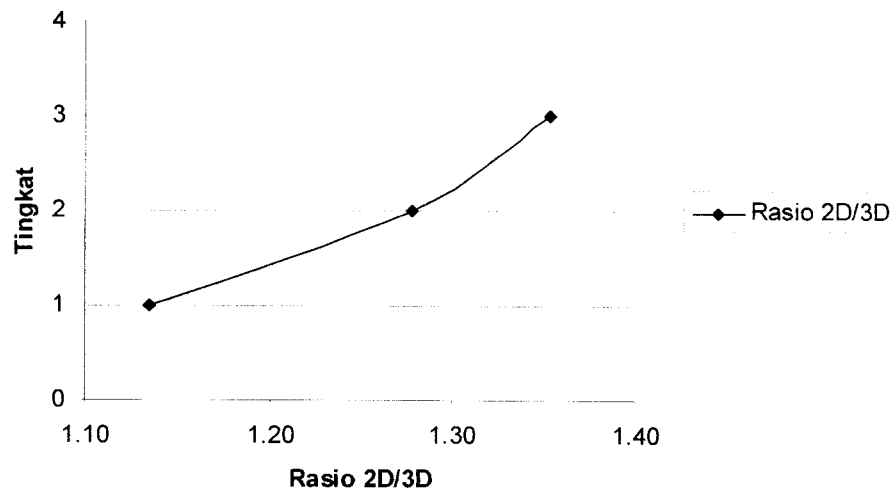

Gambar 6.15 Rasio Momen (M_{ux}) 2D/3D Kolom K3

- Kolom K3 Arah Y (M_{uy})

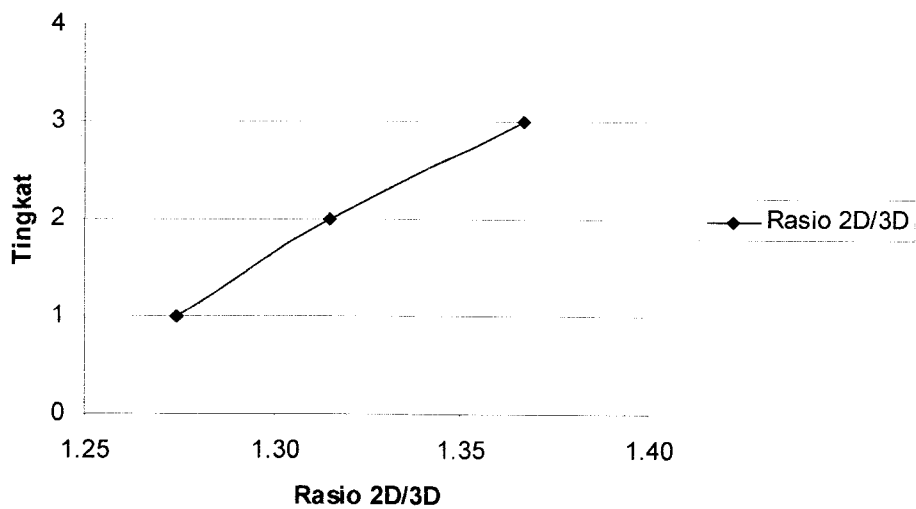

Gambar 6.16 Rasio Momen (M_{uy}) 2D/3D Kolom K3

2. Grafik Rasio Hasil Analisis Gaya Aksial (Pu) Kolom

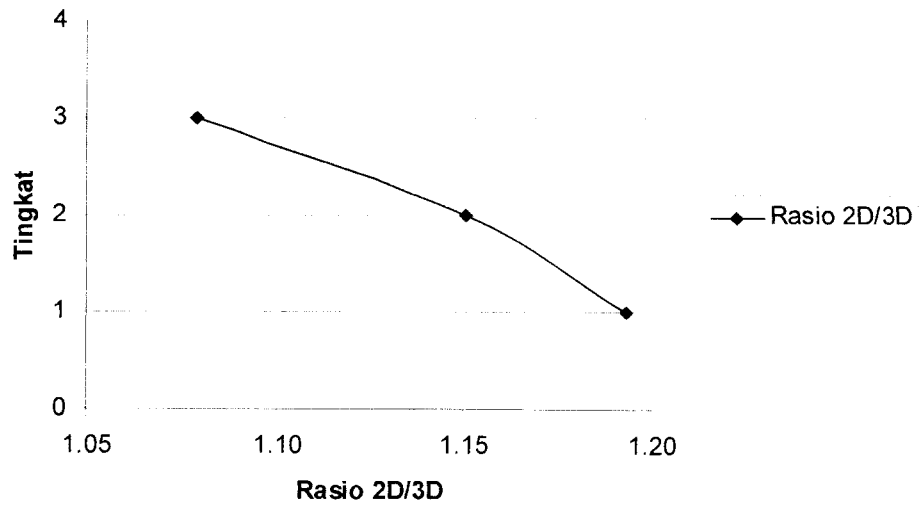

Gambar 6.17 Rasio Gaya Aksial (Pu) 2D/3D Kolom K3

3. Grafik Rasio Hasil Analisis Gaya Geser (Vu) Kolom

○ Kolom K3 Arah X (Vux)

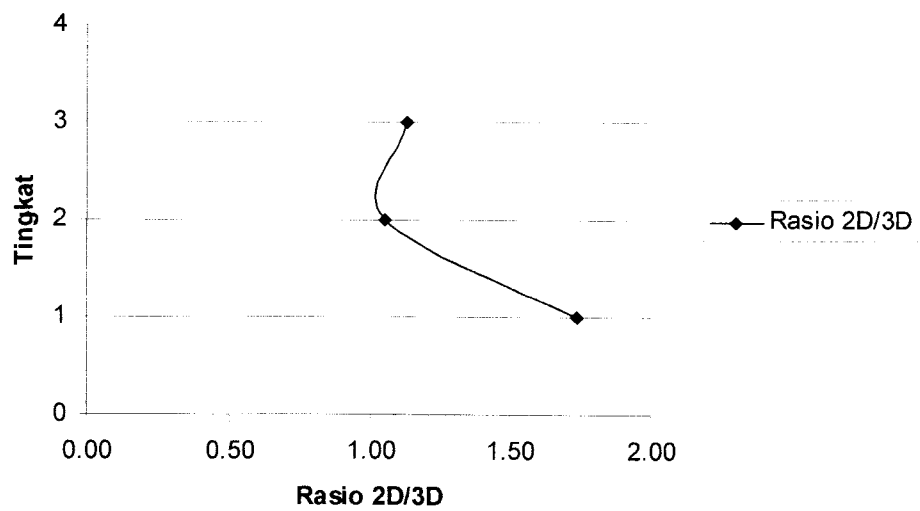

Gambar 6.18 Rasio Gaya Geser (Vux) 2D/3D Kolom K3

○ Kolom K3 Arah Y (Vuy)

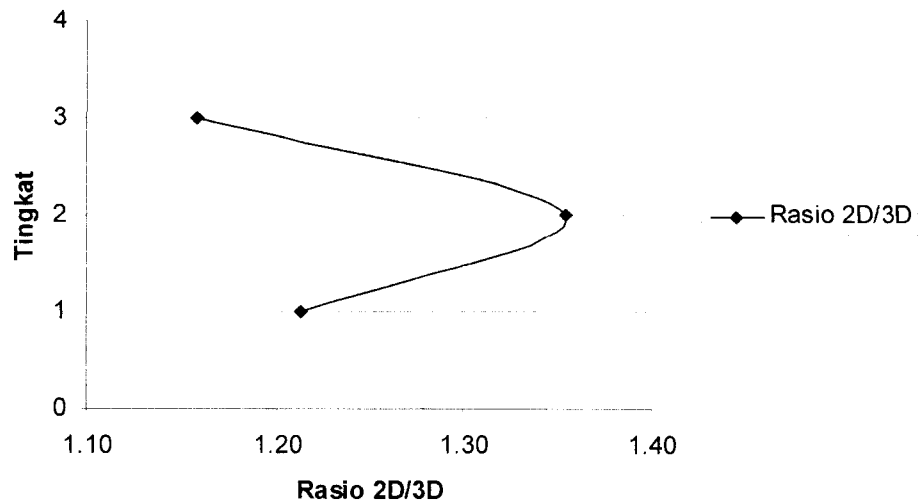

Gambar 6.19 Rasio Gaya Geser (Vuy) 2D/3D Kolom K3

6.2 Hasil Desain Struktur

○ Tabel Berat Struktur Balok

Tingkat	2D			
	Profil	Panjang Balok (m)	Berat Struktur (KN/m)	Total Berat Struktur (KN)
1	W16X36	20	0.632	37.92
2	W16X31	12	0.585	14.04
3	W14X26	4	0.465	5.58
Total Berat Struktur				57.54

Tingkat	3D			
	Profil	Panjang Balok (m)	Berat Struktur (KN/m)	Total Berat Struktur (KN)
1	W16X36	20	0.632	37.92
2	W16X31	12	0.585	14.04
3	W14X26	4	0.465	5.58
Total Berat Struktur				57.54

○ **Tabel Berat Struktur Kolom**

Tingkat	2D			
	Profil	Panjang Kolom (m)	Berat Struktur (KN/m)	Total Berat Struktur (KN)
1	W14X159	9	0.865	23.355
2	W14X99	9	0.82	14.76
3	W14X74	9	0.789	21.303
Total Berat Struktur				59.418

Tingkat	3D			
	Profil	Panjang Kolom (m)	Berat Struktur (KN/m)	Total Berat Struktur (KN)
1	W14X99	9	0.82	22.14
2	W14X61	9	0.765	13.77
3	W14X61	9	0.765	20.655
Total Berat Struktur				56.565

○ **Tabel Berat Struktur Portal As B**

Tingkat	Portal As B		Rasio
	2D	3D	
1	61.275	60.06	1.02
2	28.8	27.81	1.04
3	26.883	26.235	1.02

○ **Grafik Berat Struktur Portal As B**

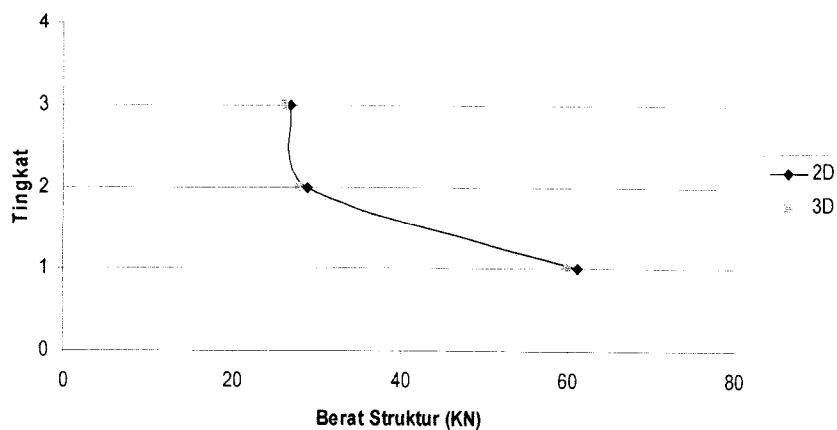

Gambar 6.20 Berat Struktur Portal As B

o **Grafik Rasio Berat Struktur 2D/3D Portal As B**

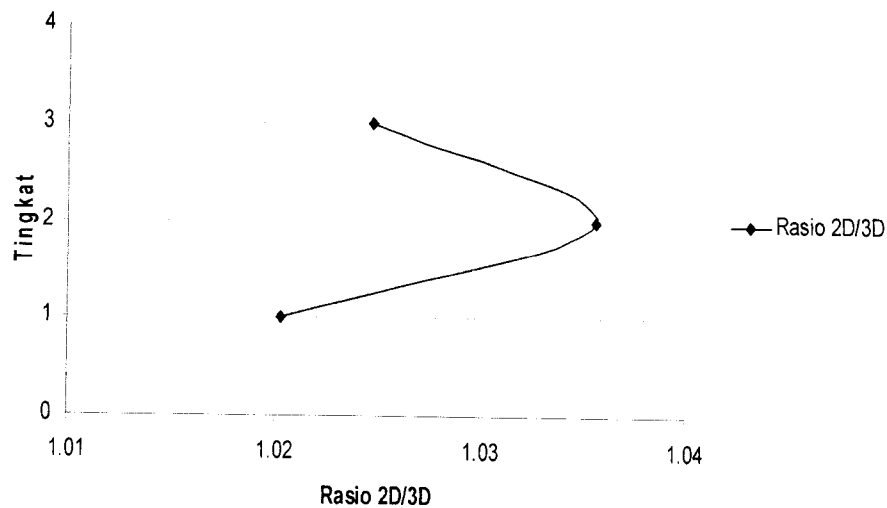

Gambar 6.21 Rasio Berat Struktur 2D/3D Portal As B

PEMBAHASAN :

- Momen perlu balok hasil analisis dua dimensi (2D) lebih besar dari pada momen perlu balok hasil analisis tiga dimensi (3D). Dikarenakan momen dalam satu join harus didistribusikan kesetiap komponen penampang struktur, momen dengan analisis dua dimensi(2D) didistribusikan pada dua arah bidang struktur, dan momen dengan analisis tiga dimensi (3D) didistribusikan pada tiga arah bidang struktur.
- Semakin tinggi tingkat bangunan, momen yang dihasilkan semakin kecil, dikarenakan beban yang bekerja pada lantai atas lebih kecil dari pada lantai dibawahnya.

- Gaya aksial kolom semakin kebawah semakin besar, dikarenakan gaya aksial kolom paling bawah merupakan penjumlahan dari gaya aksial kolom-kolom lantai sebelumnya dengan gaya aksial kolom tersebut.
- Semakin tinggi tingkat bangunan, gaya geser yang dihasilkan semakin kecil, dikarenakan beban yang bekerja pada lantai atas lebih kecil dari pada lantai dibawahnya.

BAB VII

KESIMPULAN DAN SARAN

7.1 Kesimpulan

Berdasarkan hasil analisis dan perhitungan struktur stadion Sleman dengan menggunakan analisis dua dimensi (2D) dan tiga dimensi (3D), dapat diambil kesimpulan sebagai berikut :

1. Momen-momen dan gaya-gaya yang dihasilkan dari analisis dua dimensi (2D) lebih besar dibandingkan dengan hasil analisis tiga dimensi (3D).

Dari Hasil Analisis dapat disimpulkan bahwa :

- a) Rasio momen balok 2D/3D pada portal as B yaitu berkisar dari 1,04 sampai dengan 1,16 dan pada portal as 1 yaitu berkisar dari 1,03 sampai dengan 1,31.
- b) Rasio Gaya Geser balok 2D/3D pada portal as B yaitu berkisar dari 1,02 sampai dengan 1,36 dan pada portal as 1 yaitu berkisar dari 1,20 sampai dengan 1,36.
- c) Rasio momen kolom 2D/3D pada momen kolom arah x yaitu berkisar dari 1,13 sampai dengan 1,35 untuk momen dan pada momen kolom arah y yaitu berkisar dari 1,27 sampai dengan 1,36.
- d) Rasio gaya aksial kolom 2D/3D yaitu berkisar 1,08 sampai dengan 1,19.

- e) Rasio gaya geser kolom 2D/3D pada kolom arah x yaitu berkisar dari 1,05 sampai dengan 1,12 dan pada arah y yaitu berkisar dari 1,15 sampai dengan 1,37.
2. Berat struktur baja hasil analisis dua dimensi (2D) lebih berat dibandingkan dengan hasil analisis tiga dimensi (3D) dengan nilai rasio berat struktur 2D/3D yaitu berkisar dari 1,02 sampai dengan 1,1. Hal ini dikarenakan perilaku portal bidang (2D) dan portal ruang (3D) pada struktur stadion Sleman relatif sama. sehingga banyak didapatkan dimensi profil yang sama pada elemen struktur antara hasil desain portal bidang (2D) dan portal ruang (3D).

7.2 Saran

Sebagai bahan masukan atau saran demi peningkatan kualitas kajian tentang perbedaan analisis dua dimensi (2D) dan tiga dimensi (3D), maka kami mencoba memberikan saran yaitu :

1. Melanjutkan analisis dan desain tentang perbedaan perilaku dan rasio berat struktur baja antara portal bidang (2D) dengan portal ruang (3D) dengan bentuk struktur yang lebih bervariasi.
2. Melanjutkan analisis dan desain tentang perbedaan perilaku dan rasio berat struktur baja antara portal bidang (2D) dengan portal ruang (3D) pada struktur gedung bertingkat tinggi dengan memakai beban gempa dinamis.

LAMPIRAN A

MOMEN, GAYA AKSIAL DAN GAYA GESER BALOK

MOMEN BALOK PORTAL AS 1 (ANALISIS 2D)

LABEL	STATION	MD (KN.m)	ML (KN.m)	ME (KN.m)	1,4MD (KN.m)	1,2MD+1,6WL (KN.m)	1,2iD+ML+ME (KN.m)	1,2iD+ML - ME (KN.m)	0,9MD+ME (KN.m)	0,9MD-ME (KN.m)
1	0	-106,9237	-50,12083	254,5712	-149,69318	-208,501768	-56,80287	-432,023212	158,33987	-350,80253
1	2,25	34,45977	15,76566	139,4999	48,243678	66,57678	82,38321	66,324566	170,513693	-108,486107
1	4,5	75,84276	36,05253	24,42863	106,179864	148,69536	102,63521	135,62352	92,687114	43,829854
1	6,75	14,34114	6,828152	-90,64264	20,077596	28,344112	114,68016	123,32654	77,735614	103,549666
1	9	-143,705	-65,8831	-205,7139	-201,187	-277,85896	-433,001123	-32,6152	-335,0484	76,3794
2	0	-138,5204	-64,29211	163,004	193,92856	-299,091853	-67,51259	-393,52059	38,33564	-287,67236
2	2,25	16,57758	7,328826	81,01907	23,208612	31,6192176	106,240992	-53,797148	95,938892	-66,099248
2	4,5	68,85844	31,84039	-0,9656241	96,401816	133,574752	113,5046939	115,4363421	61,0067719	62,9384201
2	6,75	17,01721	7,836337	-82,95072	23,824094	32,9587912	-54,693731	111,207739	-67,635231	98,266209
2	9	-137,6411	-63,2711	-164,9356	-192,69754	-256,41268	-393,38202	-63,51082	-288,81259	41,05861
3	0	-137,3166	-63,65654	148,003	-192,24224	-266,630384	-80,43346	-376,43946	24,41806	-271,56794
3	2,25	17,03553	7,792797	74,45959	23,849742	32,9111112	102,695013	-46,224147	69,791557	-59,127603
3	4,5	68,94688	32,13276	0,9161719	96,525632	134,148672	115,7851879	113,9528441	62,9683639	61,1360201
3	6,75	17,11246	7,957097	-72,62724	23,957444	33,2663072	-44,135191	101,119289	-57,226026	88,028454
3	9	-137,1627	-63,32794	-146,1706	-192,02778	-265,919944	-374,09376	-81,75258	-269,61703	22,72417
4	0	-136,8749	-63,47142	147,3303	-191,24486	-265,804152	-80,391	-375,0516	24,14289	-270,51771
4	2,25	17,26407	7,672286	72,82536	24,169698	33,3125416	101,41453	-44,23619	88,363023	-57,287697
4	4,5	68,96228	32,10661	-1,679625	96,547152	134,125312	113,181721	116,540971	60,386427	63,745677
4	6,75	16,91474	7,825321	70,18461	23,680636	32,8182016	-48,061601	104,307619	-60,961344	91,407876
4	9	-137,5736	-63,56535	-150,6896	-192,60304	-266,79288	-375,31327	-77,96407	-274,50584	26,87536
5	0	-137,3689	-63,63825	122,1873	-192,31646	-266,66388	-106,29363	-350,66823	-1,44471	-245,81931
5	2,25	17,11819	7,84093	62,51861	23,965466	33,087316	90,901368	-34,135852	77,924981	-47,112239
5	4,5	69,16454	32,21073	2,849903	96,830356	134,534616	118,058081	112,358275	65,097989	59,398183
5	6,75	17,46513	8,064913	-56,8128	24,451182	33,8620168	-27,795731	85,841869	-41,100183	72,537417
5	9	-136,675	-63,19028	-116,4875	-191,345	-265,114446	-343,68778	-110,71278	-239,495	-6,52
6	0	-135,3151	-67,5471	117,2351	-189,44114	-262,45348	-107,68712	-342,16332	-4,54549	-239,02169
6	2,25	17,19352	7,893559	56,96888	24,070928	33,2619184	85,494663	-28,443097	72,443048	-41,494712
6	4,5	57,26135	31,22484	-3,300365	94,16585	130,673364	168,638095	115,238825	57,23485	63,83558
6	6,75	13,58344	6,040505	-63,59861	19,016816	25,964936	-41,228977	85,910243	-51,344514	75,794706
6	9	-142,5352	-66,25321	-123,8389	-199,54328	-277,047376	-361,13435	-113,45655	-252,12058	-4,44278
7	0	-163,0235	-76,49008	162,3067	-228,2329	-318,012328	-109,81158	-434,42458	15,58555	-309,02785
7	2,5	24,30989	11,59212	80,07947	34,033846	47,71926	120,843458	-39,315482	101,956371	-58,200569
7	5	87,43118	41,56947	-2,147797	122,403652	171,428568	144,339089	148,634683	76,540265	80,835859
7	7,5	24,73122	11,70764	-84,37506	34,623708	48,409668	-42,986212	125,760164	-62,116962	106,633158
7	10	-162,1809	-76,25904	-166,5023	-227,05326	-316,631544	-437,47642	-104,27382	-312,56511	25,63949
8	0	-141,3291	-65,62424	101,9249	-197,86074	-274,593704	-133,29426	-337,14406	-25,27129	-229,12109
8	2,25	14,24843	6,456541	51,37045	19,947802	27,4285816	74,925107	-27,815793	64,194037	-38,546863

Lampiran A1

8	4,5	67,53574	31,42794	6,6160087	94,550036	131,327592	113,2868367	111,6548193	61,5251747	59,9661573
8	6,75	17,22784	7,883727	-9,73843	24,118976	33,2873712	-21,181295	78,295565	-34,233374	65,243486
8	9	-135,3703	-62,76987	-100,2929	-169,51842	-262,876152	-325,50713	-124,92133	-222,12617	-21,54037
9	0	-136,6559	-63,21397	96,47257	-191,31966	-265,130632	-126,72968	-325,67482	-24,51664	-221,46378
9	2,25	17,30091	8,03275	49,30798	24,221274	33,613492	78,101822	-20,514138	64,578799	-33,737161
9	4,5	68,96848	32,17009	0,1433987	96,555872	134,23432	115,075667	114,788673	62,2150307	61,9282333
9	6,75	17,04085	7,791803	-49,02119	23,85719	32,9159048	-20,760367	77,262013	-33,684425	64,357955
9	9	-137,177	-63,69586	-98,18578	-192,0478	-266,525776	-326,49404	-130,12248	-221,64508	-25,27352
10	0	-137,0855	-63,40444	97,65527	-191,9197	-265,949704	-130,25177	-325,56231	-25,72168	-221,03222
10	2,25	17,01748	7,898541	48,87331	23,824472	33,0586416	77,192827	-20,553793	64,169042	-33,557578
10	4,5	68,83022	32,09214	9,14E-02	96,362308	133,943688	114,7797596	114,5970484	62,0355364	61,85584236
10	6,75	17,04775	7,770124	-48,69061	23,86685	32,8894984	-20,463186	76,918034	-33,347635	64,033585
10	9	-137,0249	-63,66127	-97,47256	-191,83486	-266,287912	-325,56371	-130,61859	-220,79497	-25,84985
11	0	-137,1129	-63,38095	97,34049	-191,95806	-265,945	-130,57594	-325,25692	-26,06112	-220,7421
11	2,25	17,03637	7,931406	48,66105	23,850918	33,1338895	77,0361	-20,286	59,53783	-33,328317
11	4,5	68,89542	32,13436	-1,84E-02	96,453588	134,089512	114,7904829	114,8272851	61,96747693	62,02427907
11	6,75	17,15925	7,821749	-49,69785	24,02205	33,1058984	-20,285001	77,110699	-33,254525	64,141175
11	9	-136,8671	-63,60027	-97,3773	-191,61394	-266,000952	-325,21809	-130,46349	-220,55765	-25,80309
12	0	-136,4164	-63,01462	95,58977	-190,98296	-264,523072	-131,12453	-322,30407	-27,18499	-218,36453
12	2,25	17,11127	7,967635	48,30383	23,955778	33,28174	76,804989	-19,802671	63,703673	-32,903687
12	4,5	68,34874	31,84051	1,017892	95,688236	132,963304	114,87689	112,841106	62,531758	60,495974
12	6,75	15,991	7,197762	-46,26805	22,3874	30,7056192	-19,881088	72,655012	-31,87615	60,65995
12	9	-138,657	-64,55436	-93,55399	-194,1198	-269,675376	-324,49675	-137,38877	-218,34529	-31,23731
13	0	-143,3527	-66,1444	109,57	-200,69378	-277,85528	-128,59704	-347,73764	-19,44743	-238,58743
13	2,25	14,08205	6,607527	49,92038	19,71487	27,4705032	73,426367	-26,414393	62,594225	-37,246535
13	4,5	75,49918	35,87258	-9,729239	105,698852	147,995144	116,742357	135,200835	58,220023	77,678501
13	6,75	34,5586	15,62638	-69,37885	48,36204	66,472529	-12,28215	126,47555	-38,27611	100,46159
13	9	-107,8194	-50,21944	-129,0285	-150,94716	-209,73438-	-308,63122	-50,57422	-226,06596	31,99104
14	0	-104,7883	-52,06024	155,4253	-146,70362	-209,042344	-21,3809	-334,2315	62,11563	-250,73477
14	2,25	36,18844	14,30584	81,9082	50,663815	26,7453654	139,640158	-24,176232	114,477796	-49,338604
14	4,5	76,73816	35,0723	7,391061	107,433424	147,638214	134,549153	119,767031	76,455405	61,673283
14	6,75	13,97674	6,32751	-67,12607	19,507436	66,4632165	-44,076472	90,225666	-54,547004	79,705136
14	9	-145,7357	-65,90410	-141,6432	-204,05798	-278,9481233	-382,4542	-99,1678	-272,82333	10,46307
15	0	-137,7782	-62,77101	95,08645	-192,88948	-265,767450	-133,0184	-369,861231	-28,91393	-219,08683
15	2,25	17,15517	8,26067	47,9694	24,017238	45,832365	76,816274	9,245621	63,409053	-32,529747
15	4,5	69,07071	32,18297	0,852353	96,698994	169,385632	115,920175	143,923121	63,015992	61,311286
15	6,75	16,66343	7,589651	-46,26469	23,328802	45,9132322	-18,678923	85,9652132	-31,267603	61,261777
15	9	-138,7617	-64,11304	-93,38174	-194,26638	-277,047236	-324,00882	-137,24534	-218,26727	-31,50379
16	0	-137,1455	-63,19928	91,55599	-192,0037	-265,693448	-136,21709	-319,32987	-31,87496	-214,98684
16	2,25	17,63092	8,005816	45,77608	24,694488	33,9760096	74,9486	-16,60356	61,651108	-29,901052
16	4,5	69,40549	32,10153	-3,83E-03	97,167686	134,649036	115,3842856	115,3919504	62,46110858	62,46877342

16	6,75	16,84925	7,681625	-45,78374	23,58895	32,5097	-17,883015	73,684465	-33,619415	60,948065
16	9	-138,7248	-63,84766	-91,56366	-194,21472	-268,626015	-321,88108	-138,75376	-216,41595	-33,28865
17	0	-137,2901	-63,06969	92,93945	-192,20614	-265,65924	-134,87836	-320,75726	-30,62164	-216,50054
17	2,25	17,56589	8,09081	46,03613	24,592246	34,0246376	75,206179	-16,866081	61,845431	-30,226829
17	4,5	69,40408	32,14228	-0,8672076	97,165712	134,717544	114,5599684	116,2943836	61,5964644	63,3308796
17	6,75	16,91946	7,677953	-47,77054	23,687244	32,5880768	-19,789235	75,751845	-32,543026	62,998054
17	9	-138,583	-63,89575	-94,67387	-194,0162	-268,5328	-324,86922	-135,52148	-219,39857	-30,05083
18	0	-137,5261	-63,36782	77,65109	-192,53654	-266,419832	-150,74805	-306,05023	-46,1224	-201,42458
18	2,25	17,21054	7,958465	41,16925	24,094756	33,386192	64,793363	-12,558137	53,658736	-25,579764
18	4,5	69,28059	32,17537	4,687407	96,992826	134,6173	119,999485	110,624671	67,039938	57,665124
18	6,75	17,37907	7,876647	-31,79444	24,330698	33,4575132	-3,062909	60,525971	-16,153277	47,435603
18	9	-137,189	-63,53145	-68,27628	-192,0646	-266,27712	-296,43453	-159,88197	-191,74638	-55,19382
19	0	-135,4502	-62,42648	71,5731	-189,63028	-262,422608	-153,39362	-296,53982	-50,33208	-193,47828
19	2,25	17,40155	8,06331	30,54588	24,36217	33,783156	61,49105	-3,60071	48,207275	-16,884185
19	4,5	67,5867	31,44371	-6,481343	94,62138	131,413976	106,066407	119,029093	54,348687	67,309373
19	6,75	13,80029	6,308501	-45,50857	19,320406	26,6539436	-22,639721	68,377419	-33,088309	57,928831
19	9	-142,6527	-65,93609	-84,5358	-199,71378	-276,680984	-199,65513	-152,56353	-212,92323	-43,85163
20	0	-164,0418	-76,99391	96,01716	-229,65852	-302,042723	-177,82691	-369,86123	-51,07046	-243,65478
20	2,5	23,52555	11,00097	48,47219	32,93577	33,262323	108,21235	-9,24056	69,645185	-27,299195
20	5	86,633	40,891	0,9272215	121,2862	130,672652	113,505231	143,9233785	78,6969215	77,0424785
20	7,5	23,67141	10,94185	-46,61774	33,139974	25,945326	54,6942323	85,965282	-25,313471	67,922009
20	10	-163,7502	-77,11215	-94,16271	-229,25028	-263,36256	-393,382325	-179,44968	-241,53789	-53,21247
21	0	-143,1655	-66,10387	89,53927	-200,4317	-277,716792	-148,4582	-327,53674	-39,30968	-218,38822
21	2,25	13,1085	6,139101	48,65474	18,3519	25,5627616	70,524041	-26,785439	60,45239	36,85709
21	4,5	67,09232	31,36769	7,770202	93,929248	130,699088	119,648676	104,108272	68,15329	52,612886
21	6,75	17,48093	9,080655	-33,11433	24,473302	33,906164	-4,056559	62,172101	-17,381493	48,847167
21	9	-134,4207	-62,31576	-73,99885	-188,78898	-261,010056	-297,61946	-149,52174	-194,97749	-46,97977
22	0	-136,9675	-63,57206	61,47105	-191,7545	-266,076296	-166,46201	-289,40411	-61,7997	-164,7418
22	2,25	17,21286	7,86451	30,1428	24,098004	33,238648	58,662742	-1,622858	45,634374	-14,651226
22	4,5	69,10297	32,1917	-1,185445	96,744158	134,430284	113,329819	116,300709	61,007228	63,379118
22	6,75	17,59787	8,03276	-32,61369	24,357018	33,6826856	-3,63297	61,33441	-16,855607	48,171773
22	9	-136,5974	-63,29453	-63,84193	-191,23636	-265,188128	-291,05334	-163,36948	-186,77959	-59,09573
23	0	-137,9549	-63,93101	65,74343	-193,13686	-267,835496	-163,73346	-295,22032	-58,41596	-189,90234
23	2,25	16,59591	7,660721	32,92536	23,234274	32,1722456	60,501173	-5,349547	47,861679	-17,989041
23	4,5	68,85651	32,14307	0,1072847	96,399114	134,056724	114,8781667	114,6635973	62,0781437	61,8635743
23	6,75	17,5219	8,1098	-32,71079	24,53066	34,00196	-3,57471	61,84687	-16,94108	48,4805
23	9	-136,1029	-63,03285	-65,52886	-190,54406	-264,17604	-291,88519	-160,82747	-188,02147	-56,96375
24	0	-138,1947	-64,02997	65,63629	-193,47238	-268,281592	-164,22732	-295,4999	-58,73894	-190,01152
24	2,25	16,52513	7,587766	32,74316	23,135182	31,9705816	60,161082	-5,325238	47,615777	-17,870543
24	4,5	68,95477	32,09512	-0,149961	96,536678	134,099516	114,691853	114,991805	51,909332	62,209254
24	6,75	17,78922	8,088852	-33,04309	24,904908	34,285272	-3,607174	62,479006	-17,032792	49,053388

24	9	-135,6366	-63,02779	-65,93621	-189,93324	-263,64434	-291,76392	-159,8915	-188,03615	-55,16773
25	0	-137,7372	-64,176	63,50863	-192,83208	-267,96624	-165,95201	-292,95927	-60,45485	-57,4727
25	2,25	16,43816	7,545356	32,52332	23,013424	31,7999616	59,795468	-5,251172	47,317664	77,728773
25	4,5	68,3233	32,15934	1,537999	95,65262	133,442904	115,685299	112,609301	63,028969	52,952577
25	6,75	16,61324	8,256698	-29,44732	23,258536	33,1466048	-1,254734	57,639906	-14,495404	44,399233
25	9	-137,387	-62,75532	-60,43263	-192,3418	-265,272912	-288,05235	-167,18709	-184,08093	-63,21557
26	0	-144,5046	-65,96378	79,24721	-202,30644	-278,947568	-160,12209	-318,61651	-50,80693	-239,30733
26	2,25	13,88304	6,303386	33,6545	19,436256	26,7450656	56,617534	-10,691466	46,149236	-21,155754
26	4,5	76,25314	35,08368	-11,93821	106,754396	147,637656	114,649238	138,525658	56,689616	60,566533
26	6,75	36,26553	14,35271	-57,53092	50,771742	66,482972	0,340426	115,402266	-24,891943	90,169597
26	9	-105,1595	-51,97787	-103,1236	-147,2233	-209,355992	-281,29287	-75,04567	-197,76715	8,48533
27	0	-43,51921	-40,62688	55,4666	-60,926894	-117,22606	-65,326532	-148,316532	16,299311	-94,633559
27	2,25	19,97155	21,92127	30,94613	27,96017	36,951453	43,001232	14,941	48,920525	-12,971733
27	4,5	37,45554	38,86979	6,425662	52,437756	120,853231	94,037325	77,390776	40,135648	27,284324
27	6,75	6,504051	6,307058	-18,09481	8,9256714	38,3853456	14,614332	31,9667392	-12,421641	23,7954553
27	9	-67,52961	-69,74253	-42,61528	-94,541454	-208,737432	-191,735236	-108,162782	-103,391929	-16,161553
28	0	-64,45279	-65,51447	31,36268	-90,233906	-182,1665	-111,495138	-174,220498	-26,644831	-59,370197
28	2,25	6,815974	6,456464	15,65626	9,5423636	18,5095112	30,2918928	-1,0206272	21,7906366	-9,5218334
28	4,5	31,27324	31,31802	-5,02E-02	43,782536	87,63672	68,79573993	68,89607607	28,09574793	23,19668477
28	6,75	7,704039	7,663969	-15,75659	10,7856546	1,5071972	1,1522258	32,6654058	-8,8229549	22,6922257
28	9	-62,67666	-63,09947	-31,46302	-87,747324	-176,171144	-169,774482	-106,848442	-87,872014	-24,545574
29	0	-62,62465	-62,76527	28,62196	-87,67451	-175,574012	-109,29289	-166,53681	-27,740225	-54,984743
29	2,25	8,065906	8,318777	15,04031	1,2922684	22,9891304	33,0381742	2,9575542	22,2996254	-7,7609546
29	4,5	31,94497	32,29345	1,45867	44,722958	90,003484	72,086084	69,168744	30,209143	27,291503
29	6,75	7,797553	7,752505	-12,12297	10,9165742	21,7610716	4,9859986	29,2325386	-5,1051723	19,1407677
29	9	-63,16135	-63,89782	-25,70462	-88,42589	-178,030132	-165,39606	-113,98682	-62,549835	-31,140553
30	0	-62,75212	-63,14516	38,18805	-87,852968	-176,3348	-100,259654	-176,635754	-18,288858	-94,664953
30	2,25	7,855446	7,995847	19,60291	10,9976244	21,62832	35,114212	-2,1805278	26,6728114	-12,5330086
30	4,5	31,7268	32,02747	1,017792	44,41752	83,277232	67,231233	69,081848	29,571902	27,536339
30	5,75	7,646935	7,543486	-17,56735	10,705709	10,21232	6,258323	34,287158	-10,6851085	24,4495915
30	9	-63,16915	-64,04988	-36,15248	-68,43681	-193,859453	-182,489322	-103,70038	-93,094715	-20,699755
31	0	-62,98026	-63,65183	27,22766	-88,172364	-177,48324	-112,040482	-166,495902	-29,454574	-63,908564
31	2,25	7,724529	7,940278	13,67455	10,9143405	21,9736796	30,2847628	4,1351628	20,0266261	-6,1224733
31	4,5	31,91891	32,463	-1,07857	44,686474	90,243492	69,687122	71,844262	27,648449	29,805563
31	6,75	8,387892	8,470105	-15,23169	11,7430488	23,6176384	3,3038854	33,7672654	-7,6825872	22,7607925
31	9	-61,65353	-62,63217	-29,3848	-86,314942	-174,195708	-166,001206	-107,231606	-84,872977	-26,103377
32	0	-60,60248	-61,44111	34,42021	-84,843472	-171,028752	-99,743876	-168,584295	-20,122022	-88,962442
32	2,25	7,615111	7,805992	18,16978	10,6611554	21,6277204	35,1139052	1,2256548	25,0233799	-11,3161801
32	4,5	29,47283	29,94371	1,919344	41,267962	83,277332	67,23045	63,391762	28,444891	24,606203
32	6,75	3,755695	3,565816	-14,33109	5,257973	10,2121396	-6,25844	22,40374	-10,9509645	17,7112155
32	9	-68,32131	-69,92146	-50,58152	-95,649834	-193,859908	-182,488552	-121,325512	-92,070699	-30,907559

K29	K1	K2	K3	K4	K5	K6	K7	K8	K9	K10	K11	K12	K13	K14	K15	K16	K17	K18	K19	K20	K21	K22	K23	K24	K25	K26	K27	K28	K29	K30	
14	K1A	K1B	K1C	K1D	K1E	K1F	K1G	K1H	K1I	K1J	K1K	K1L	K1M	K1N	K1O	K1P	K1Q	K1R	K1S	K1T	K1U	K1V	K1W	K1X	K1Y	K1Z	K20A	K20B	K20C	K20D	K20E
27	1	2	3	4	5	6	7	8	9	10	11	12	13	14	15	16	17	18	19	20	21	22	23	24	25	26	27	28	29	30	

MOMEN BALOK PORTAL AS 2 (ANALISIS 2D)

LABEL	STATION	MD (KN.m)	ML (KN.m)	ME (KN.m)	1,4MD (KN.m)	1,2MD+1,6ML (KN.m)	1,2MD+ML+ME (KN.m)	1,2MD+ML - ME (KN.m)	0,9MD+ME (KN.m)	0,9MD-ME (KN.m)
1	0	65,24702	-63,81573	188,0854	-91,345828	-180,401552	-129,232221	-330,197554	-129,332229	-246,807718
1	1,8	37,75572	36,77035	103,9225	52,858008	104,139424	185,999714	-21,845286	137,902648	-69,942352
1	3,6	92,39804	90,28193	19,7597	129,357256	255,328736	220,919278	181,399878	102,917936	63,398536
1	5,4	5,647574	6,149767	-64,40313	7,9066036	16,616716	51,476323	77,3299858	-59,3203134	69,4859466
1	7,2	-121,8563	-116,8624	-148,566	-170,59882	-333,2074	-411,65596	-114,523396	-258,23667	38,89533
2	0	-122,567	-115,889	106,6488	-171,5938	-332,5028	-156,3206	-369,6182	-3,6615	-216,9591
2	2,25	20,31641	18,9136	51,8905	28,442974	54,641452	95,183792	-8,597209	70,175269	-33,605731
2	4,5	63,4716	59,49741	-2,867833	88,86024	171,361776	132,795497	138,531163	54,256607	59,992273
2	6,75	4,288573	3,049973	-57,62616	6,0040022	10,0262444	-49,4298994	65,8224206	-53,7664443	61,4858757
2	9	-154,6227	-147,6162	-112,3945	-216,47178	-421,73316	-445,54794	-220,77894	-251,54493	-26,77593
3	0	-173,2929	-167,0654	113,9069	-242,61006	-475,25612	-261,10798	-488,92578	-42,05471	-269,87251
3	2,25	36,81181	36,14869	57,58485	51,536534	102,012076	137,907712	22,738012	90,715479	-24,454221
3	4,5	102,3323	100,144	1,260792	144,16522	283,74916	224,923552	222,401639	53,899862	91,378278
3	6,75	22,45855	22,10817	-55,06326	31,44197	62,323332	-6,00483	104,12169	-34,850565	75,275955
3	9	-201,9995	-195,1465	-111,3973	-282,7993	-554,6334	-548,9332	-326,1586	-293,18685	-70,41225
4	0	-197,8375	-190,8752	108,0272	-276,9725	-542,80532	-320,253	-536,3074	-70,02655	-286,08095
4	2,25	21,68586	21,01781	54,32708	30,360204	59,651528	101,367922	-7,286238	73,844354	-34,809806
4	4,5	97,22495	93,69203	0,269287	136,11493	266,577168	210,9888987	209,7350413	88,1293837	66,8755263
4	6,75	26,16982	24,33505	-53,07323	36,637748	70,339864	2,665604	108,812064	-29,520392	76,626068
4	9	-188,8696	-184,2407	-106,7734	-264,41744	-521,42864	-517,65762	-304,11082	-276,75604	-63,20924
5	0	-195,7664	-189,2206	104,3629	-274,07296	-537,67264	-319,77738	-528,50318	-71,82686	-280,55266
5	2,25	22,54871	22,22563	52,53483	31,568194	62,619988	101,819242	-3,250418	72,828669	-32,240991
5	4,5	96,87954	94,45374	0,7069033	135,631356	267,381432	211,4159913	210,0023847	87,8983893	86,4847827
5	6,75	24,61616	24,65032	-51,12122	34,452624	68,979904	3,068492	105,310932	-28,966676	73,275764
5	9	-191,6315	-184,3719	-102,9492	-268,2841	-524,95234	-517,2789	-311,3805	275,41755	-69,51915
6	0	-186,5382	-181,6752	101,6907	-261,15348	-514,52616	-303,83034	-507,21174	-66,19368	-269,57508
6	2,25	25,44946	23,67998	50,75948	35,629244	68,42732	104,978812	3,459852	73,663994	-27,854966
6	4,5	93,45288	89,81635	-0,1716864	130,854032	255,849516	201,7881096	202,1315024	83,5368956	84,2792884
6	6,75	14,86208	13,9215	-51,10288	20,806912	40,108896	19,3466232	82,858876	-37,727008	64,478752
6	9	-207,713	-201,1921	-102,0341	-290,7982	-571,16296	-552,4818	-348,4136	-288,9758	-84,9076
7	0	-229,9973	-223,3297	92,93948	-321,99624	-633,32428	-406,38698	-592,26594	-114,05809	-299,93705
7	2,5	36,73632	36,1442	46,71131	51,430848	101,914304	126,9390984	33,516474	79,773998	-13,63622
7	5	126,6802	123,7906	0,483128	177,35278	350,0812	276,2899728	125,832184	-12,787832	78,702248
7	7,5	36,61912	36,1442	-45,74504	51,266768	101,773664	34,342104	407,63452	-299,18175	-115,23531
7	10	-230,2317	-223,3297	-91,97322	-322,32438	-533,60556	-591,58596	-407,63452	-90,0797	-284,88244
8	0	-208,3123	-201,1921	97,40137	-291,63722	-571,82212	-353,76549	-548,58823	62,260396	-36,198844
8	2,25	14,47864	13,9215	49,22962	20,270096	39,648768	80,525468	-17,933752		

Lampiran A2

6	4,5	93,28553	89,81635	1,057872	130,599452	255,648556	202,816610	200,700874	55,014659	82,959525
6	6,75	25,49762	23,67998	-47,11388	35,696948	68,485352	7,163484	101,391244	-24,165842	70,061918
9	9	-186,274	-181,6752	-95,28563	-260,7836	-514,20912	-500,48963	-309,91837	-252,93223	-72,36097
9	0	-191,3038	-184,3719	93,22224	-267,82532	-524,5596	-320,71422	-507,1587	-78,95115	-265,39566
9	2,25	24,81566	24,65032	46,72672	34,742232	69,219568	101,156096	7,702656	69,061012	-24,392428
9	4,5	96,9513	94,45374	0,2311989	135,73182	267,467544	211,0264989	210,5641011	87,4873689	57,0249711
9	6,75	22,49252	22,22596	-46,26432	31,489528	62,55256	2,952864	95,481304	-26,021052	56,507586
9	9	-195,9505	-189,2206	-92,75984	-274,3307	-537,89356	-517,12104	-331,60136	-269,11525	-83,59561
10	0	-188,7924	-184,2407	91,77843	-264,30936	-521,336	-319,61315	-502,57001	-78,13473	-261,69159
10	2,25	26,20228	24,33505	46,03937	36,683192	70,378816	101,817156	9,738416	69,621422	-22,457318
10	4,5	97,21265	93,69203	0,3003075	136,09771	266,562428	210,6475175	210,0469025	67,7916925	57,1910775
10	6,75	21,6288	21,01781	-45,43876	30,28032	55,583056	1,53361	92,41113	-25,97284	64,90468
10	9	-197,9393	-190,8752	-91,17782	-277,11502	-542,92748	-519,58018	-337,22454	-259,32319	-86,96755
11	0	-201,8819	-195,1465	90,81814	-282,53466	-554,49262	-346,58664	-526,22292	-90,57557	-272,51185
11	2,25	22,51643	22,10817	45,34204	31,525602	62,395188	94,472326	3,788246	65,608627	-25,075453
11	4,5	102,9345	100,144	-0,1340467	144,1083	283,7518	223,5313533	223,7994467	92,5070033	52,7750967
11	6,75	36,75644	36,14869	-45,61014	51,455016	101,945532	34,64278	125,866558	-12,52934	76,690936
11	9	-173,4055	-167,0654	-91,08624	-242,76626	-475,35172	-466,23872	-284,06624	-247,15155	-84,97907
12	0	-154,5145	-147,6162	87,41847	-216,32044	-421,60344	-245,61525	-420,45214	-51,64457	-226,45161
12	2,25	4,343709	3,049973	45,09963	6,081152	10,0924076	53,3620538	-36,8372062	43,0089661	-1,1902919
12	4,5	63,47372	59,49741	2,780788	88,863208	171,36432	138,448662	132,865086	59,907136	54,34556
12	6,75	20,26551	18,9136	-39,53806	28,37174	54,580372	3,694152	82,770272	-21,299101	57,777019
12	9	-122,671	-115,889	-81,8569	-171,7394	-332,6216	-344,9511	-181,2373	-192,2606	-26,547
13	0	-121,7268	-116,8624	108,8833	-170,41752	-333,052	-154,05126	-371,81786	-0,67082	-218,43742
13	1,8	5,705226	6,149767	47,86742	7,9873164	16,6858954	60,8634582	-34,8713818	53,0021234	-42,7327166
13	3,6	92,38356	90,28193	-13,14843	129,337404	255,31172	187,994132	214,290992	-69,997044	96,293904
13	5,4	37,66971	36,77035	-74,16428	52,737594	104,026212	7,809722	156,138282	-40,261541	108,067019
13	7,2	-65,40486	-63,81573	-135,1801	-91,566804	-180,591	-277,481662	-7,121462	-194,044474	76,315726
14	0	-72,02744	-70,91975	83,20469	-100,638416	-199,905528	-74,147988	-240,557368	16,379994	-148,029386
14	1,8	35,51725	34,61032	44,9899	49,72415	97,997212	122,12092	32,34112	76,855425	-12,924375
14	3,6	94,70152	93,0655	5,575117	132,532128	262,547284	213,282841	200,132607	91,806455	78,656251
14	5,4	12,493	13,87771	-31,73967	17,4902	37,195956	2,67232	60,60899	-20,49597	42,96337
14	7,2	-110,469	-104,1905	-70,05445	-154,6566	-299,2676	-306,80775	-166,69885	-169,47655	-29,36765
15	0	-103,6899	-94,71617	58,34631	-145,16586	-275,973752	-160,79774	-277,49036	-34,9746	-151,66722
15	2,25	2,887168	0,1859845	28,8133	4,0420352	3,7621768	32,4638861	-25,1627139	31,417512	-26,2148488
15	4,5	54,03546	47,97876	-0,7196949	75,649644	141,608568	112,1016171	113,5410069	47,9122191	49,3516089
15	6,75	29,61977	28,62311	-30,2527	41,467678	81,3407	33,914134	94,419534	-3,594907	56,910493
15	9	-102,2402	-90,5763	-59,78569	-143,13628	-267,61032	-173,05023	-153,47885	-51,80187	-32,23049
16	0	-84,42562	-73,38778	59,25515	-118,196868	-218,731192	-115,443374	-233,953674	-16,727903	-135,236208
16	2,25	2,85279	1,243367	29,67093	3,993906	5,4127352	34,337645	-25,004215	32,23844	-27,103419
16	4,5	34,70245	28,76514	0,086711	48,58343	87,667164	70,494791	70,321369	31,318916	31,145494

Lampiran A2

16	6,75	9,818369	7,77129	-29,49751	13,7457166	24,2161068	-9,9441772	49,0508428	-20,6609779	38,3340421
16	9	-70,49446	-60,33194	-59,08172	-98,692244	-181,124456	-204,007012	-85,843572	-122,526734	-4,363294
17	0	-63,63796	-55,71772	58,71813	-89,093144	-165,513904	-73,365142	-190,801402	1,443966	-115,992294
17	2,25	10,03651	8,894133	29,43201	14,051114	26,2744248	50,369955	-8,494065	38,464869	-20,399151
17	4,5	28,28223	26,39661	0,1458853	39,595122	76,173252	60,4811713	60,1894007	25,5998923	25,3081217
17	6,75	-10,20578	-4,616526	-29,14024	-14,283092	-15,6333898	-46,003704	12,276776	-38,325442	19,955038
17	9	-104,1225	-82,73904	-58,42636	-145,7715	-257,329464	-266,1124	-149,25968	-152,13661	-35,28389
18	0	-145,8499	-109,0439	57,92424	-204,18986	-349,49012	-226,13954	-341,98802	-73,34067	-189,18915
18	2,25	39,90712	27,94118	29,03375	55,869968	92,594432	104,863474	46,795974	64,950158	6,882658
18	4,5	99,01385	70,7075	0,143255	138,61939	231,94862	139,637375	189,380865	89,25572	88,96921
18	6,75	28,86037	16,44259	-28,74724	40,404518	60,940588	22,327794	79,822274	-2,772907	54,721573
18	9	-167,9434	-132,0411	-57,53773	-235,12076	-412,79784	-391,21091	-275,93545	-208,78679	-93,51133
19	0	-144,3014	-126,4589	57,31482	-202,02196	-375,45592	-242,30576	-356,9354	-72,55644	-187,18608
19	2,25	7,629761	14,37525	28,57205	10,6816654	32,1561132	52,1030532	-5,0411268	35,4388749	-21,7053051
19	4,5	59,83263	60,99066	-0,170628	83,765682	169,384212	132,619188	132,960444	53,676739	54,019995
19	6,75	9,697276	10,57484	-28,91335	13,57618664	28,5564752	-6,7017788	51,1249212	-20,1958016	37,6408984
19	9	-140,1663	-134,0598	-57,65607	-196,23282	-382,89524	-359,91543	-244,60329	-183,80574	-68,4936
20	0	-164,1692	-152,2271	53,40262	-229,63688	-440,5664	-295,82732	-402,63296	-94,34946	-201,1551
20	2,5	33,71218	24,07179	26,76529	47,197052	78,96948	91,291696	37,761116	57,106252	3,575672
20	5	95,01965	83,99429	0,1277614	133,02751	248,414444	198,1456314	197,8901086	85,6454464	85,3899236
20	7,5	16,53051	24,07179	-26,50977	23,142714	58,351476	17,398632	70,418172	-11,632311	41,387229
20	10	-156,5025	-152,2271	-53,1473	-219,1035	-431,36636	-393,1774	-286,8628	-193,99955	-87,70495
21	0	-136,9292	-134,0598	56,43235	-191,70088	-378,81072	-241,94249	-354,80719	-66,80393	-179,66863
21	2,25	11,88133	10,57484	28,41975	16,633862	31,17734	53,252186	-3,587314	39,112947	-17,28553
21	4,5	60,96357	60,99066	0,4071582	85,348998	170,74134	134,5541022	133,7397858	55,2743712	54,4600548
21	6,75	7,707573	14,37525	-27,60544	10,7905022	37,2494876	-3,9811024	51,2297776	-20,6686243	34,5422557
21	9	-145,2767	-126,4589	-55,61803	-203,38738	-376,66628	-356,40897	-245,17291	-186,36706	-75,131
22	0	-168,0547	-132,0411	55,096	-235,27658	-412,9314	-272,61074	-388,80274	-95,15323	-206,34523
22	2,25	28,7463	16,44259	27,58925	40,24482	60,803704	78,5274	23,3489	55,46092	-1,71758
22	4,5	98,89703	70,7075	8,25E-02	138,455942	231,809436	189,4664348	189,3014372	89,03982577	88,92482823
22	6,75	39,78753	27,94118	-27,42425	55,702542	92,450924	48,261966	103,110466	8,384527	63,233027
22	9	-145,9722	-109,0439	-54,931	-204,36108	-349,63688	-339,14154	-229,27954	-186,30598	-76,44398
23	0	-103,8371	-82,73904	54,65111	-145,37194	-256,986984	-152,65245	-261,99467	-38,80228	-148,1045
23	2,25	-10,05093	-4,616528	27,35572	-14,071302	-19,4475608	10,678076	-44,033364	18,309883	-36,401557
23	4,5	28,30644	26,39661	6,03E-02	39,629016	75,202304	60,42467488	60,30400112	25,53613288	25,41545912
23	6,75	9,930075	8,894133	-27,23505	13,902105	26,1467028	-6,424827	48,045273	-18,2979825	36,1721175
23	9	-63,87504	-55,71772	-54,53044	-89,425056	-165,7984	186,858208	-77,837328	-112,017976	-2,957096
24	0	-70,3016	-60,33194	54,27187	-98,42224	-180,893024	-90,42199	-198,96573	-8,99957	-117,54331
24	2,25	9,914053	7,77129	27,16217	13,8796742	24,3309276	46,8303236	-7,4940164	36,0848177	-18,2355223
24	4,5	34,70095	28,76514	5,25E-02	48,58133	87,665364	70,45875282	70,35380718	31,28332782	31,17838218
24	6,75	2,754112	1,243367	-27,05722	3,8557568	5,2943216	-22,5089186	31,6055214	-24,5785192	29,5359208

Lampiran A2

33	0	-80,51282	-71,85014	19,46822	-112,717948	-211,575608	-148,819304	-188,111744	-52,815318	-32,107758
33	2,5	13,09377	11,04931	9,813759	18,331278	33,39142	36,575593	16,948075	21,598152	1,970634
33	5	44,70248	39,28063	-0,0187053	62,583472	116,459984	92,8849007	92,9223113	40,2135267	40,2509373
33	7,5	12,81504	11,04931	-9,85117	17,941056	33,056944	16,576188	36,278528	1,682366	21,384706
33	10	-81,07027	-71,85014	-19,68363	-113,498378	-212,244548	-188,818094	-149,450834	-92,646873	-53,279613
34	0	-74,39164	-66,63609	20,50771	-104,148296	-195,867712	-135,398346	-176,413768	-46,444766	-87,460186
34	2,25	4,754255	5,99276	10,29664	6,655957	15,293522	21,994506	1,401226	14,5754695	-6,0178105
34	4,5	33,40039	31,51222	8,56E-02	46,760546	90,50002	71,67825815	71,50711785	30,14592115	29,97478085
34	6,75	10,33179	8,516074	-10,1255	14,464506	26,0238664	10,788722	31,039722	-0,826889	19,424111
34	9	-63,23656	-61,58846	-20,33657	-88,531184	-174,427008	-157,809902	-117,136762	-77,249474	-36,576334
35	0	-67,09694	-62,23129	20,52567	-93,935716	-180,086392	-122,221948	-153,273288	-39,861576	-80,912916
35	2,25	8,393312	8,282967	10,27442	11,7506368	23,3247216	26,6293614	8,0805214	17,8284009	-2,7204392
35	4,5	33,38381	31,68784	2,32E-02	46,737334	90,761116	71,77156935	71,72525465	30,06858635	30,02227165
35	6,75	6,659571	6,577097	-10,2281	9,3233994	18,5148404	4,3404822	24,7956822	-4,2344861	16,2217139
35	9	-70,56442	-65,64303	-20,47936	-98,790188	-189,706152	-170,799694	-129,840974	-83,967338	-43,028618
36	0	-63,27485	-60,994	20,47413	-86,58479	-173,52022	-116,44969	-157,39795	-36,473235	-77,421495
36	2,25	11,15832	9,259671	10,22097	15,521648	28,2052976	32,870525	12,428565	20,263458	-0,178482
36	4,5	35,09174	32,40376	-3,22E-02	49,128436	93,95e104	74,48166935	74,54602665	31,55038735	31,61474465
36	6,75	7,310424	7,032347	-10,28533	10,2345936	20,0242544	5,5195198	26,0901798	-3,7059464	16,8647116
36	9	-70,97065	-65,44846	-20,53848	-99,35891	-189,882316	-171,15172	-130,07476	-84,412055	-43,335105
37	0	-72,19481	-66,68259	20,33798	-101,072734	-193,326396	-132,978682	173,654642	-44,637349	-85,313309
37	2,25	5,913006	6,023091	10,27e05	3,2782084	16,7325528	23,3467482	2,8906482	15,5497554	-4,9063446
37	4,5	33,52107	31,6197	0,1181321	46,929498	90,816804	71,9631161	71,7268519	30,2870951	30,0508309
37	6,75	9,41439	8,700663	-9,99179	13,180146	25,2183608	10,006161	29,589741	-1,518839	18,464741
37	9	-65,13204	-61,32771	-20,10171	-91,268856	-176,354784	-159,659868	-119,456448	-78,774546	-38,571126
38	0	-71,96327	-67,84611	21,10631	-100,748578	-194,9097	-133,095724	-175,398344	-42,660633	-85,873253
38	2,25	8,371233	7,551466	10,63906	11,7197262	22,1278252	28,2360056	6,9578856	18,1731697	-3,1049503
38	4,5	38,20599	35,83966	0,1718047	53,485386	103,190644	81,8586527	81,5150433	34,5571957	34,2135863
38	6,75	16,326	15,61224	-10,29545	22,8564	44,570794	24,90799	45,49889	4,39795	24,98885
38	9	-56,05374	-51,72457	-20,7627	-78,475236	-150,9239	-139,751758	-98,226358	-71,211066	-29,6856665
39	0	-50,90121	-47,367	21,87694	-71,261694	-136,868652	-86,56612	-130,328292	-23,931249	-67,690929
39	1,8	0,5099624	0,6123002	9,051622	0,71394736	1,5916352	10,27587708	-7,62736632	9,51058816	-9,59265584
39	3,6	30,45218	29,1516	-3,776593	42,633052	83,185176	61,917623	69,470809	23,630369	31,183555
39	5,4	13,53752	12,3309	-16,60481	18,952528	35,974464	11,971114	45,180734	-4,421042	28,788578
39	7,2	-24,8461	-23,92979	-29,43302	-34,78454	-68,102984	-83,17813	-24,31209	-51,79451	7,07153

MOMEN BALOK PORTAL A (ANALISIS 2D)

LABEL	STATION	MD (KN.m)	ML (KN.m)	ME (KN.m)	1.4MD (KN.m)	1.2MD+1.6ML (KN.m)	1.2MD+ML+ME (KN.m)	1.2MD+ML - ME (KN.m)	0.9MD+ME (KN.m)	0.9MD-ME (KN.m)
1	0	-21,17582	-22,03973	207,5096	-29,646148	-60,674552	160,058886	-254,960314	188,451362	-226,567838
1	1	-3,443539	-4,059676	114,6544	-4,8209546	-10,6277284	106,4624772	-122,8463228	111,5552149	-117,7535851
1	2	3,862481	4,03214	21,79909	5,4354734	11,1089196	30,4892812	-13,1088988	25,2933229	-18,3048571
1	3	-4,347382	-3,316229	-71,06619	-6,086348	-10,5228248	-79,5892774	62,5231026	-74,9688338	67,1435462
1	4	-22,9835	-20,55284	-163,9115	-32,1769	-60,464744	-212,04454	115,77846	-184,59665	143,22635
2	0	-61,25543	-56,78358	101,7853	-85,757602	-164,360244	-28,504796	-232,075396	46,655413	-156,915187
2	2	19,2168	18,29021	48,50137	26,90352	52,324496	89,85174	-7,151	65,75649	-31,20625
2	4	43,25467	40,22401	-4,782613	60,585538	116,42402	87,447001	97,012227	34,14659	43,711816
2	6	9,550096	9,557805	-58,06659	13,3701344	26,7526032	-37,0486698	79,0645102	-49,4715036	66,6616764
2	8	-57,95884	-52,3484	-111,3506	-81,156376	-153,320048	-233,261608	-10,560408	-163,522556	59,178644
3	0	-49,77863	-45,31279	118,4892	-69,690082	-132,23482	13,442054	-223,596346	73,688433	-163,289967
3	2	-3,579666	-4,398035	55,89215	-5,0715324	-11,3324552	47,1985158	-64,5857842	52,6704506	-50,1138494
3	4	22,34487	19,96717	-6,704847	31,282818	56,761316	40,076167	53,485861	13,405536	26,81523
3	6	26,72186	26,41093	-69,30184	37,410604	74,32372	-10,824678	127,79002	-45,252166	93,351514
3	8	17,77788	23,79808	-131,8988	24,889032	59,410384	-86,767264	177,030336	-115,888708	147,898892
4	0	-27,47219	-30,0934	14,56461	-38,461066	-81,116068	-48,495418	-77,524636	-10,160361	-39,289581
4	1	-4,051736	-4,205907	7,315089	-5,6725144	-11,5916064	-1,7529732	-16,3531512	3,6664726	-10,9617054
4	2	8,962341	11,79242	6,56E-02	12,5472774	29,6226812	22,61279961	22,46165879	8,13167731	8,00053649
4	3	6,420596	12,35242	-7,183948	8,9888344	27,4685872	12,8731872	27,2410832	-1,4054116	12,9624844
4	4	-6,527408	3,023244	14,43347	-9,1383712	-2,9956992	-19,2431156	9,6238244	-20,3061372	8,5588028
5	0	-45,65455	-28,98833	11,08064	-63,91637	-101,166788	-72,69315	-94,85443	-30,008455	-52,169735
5	2	9,500306	5,527095	7,612864	13,8604284	22,3737152	26,0203262	10,7945982	16,5231394	1,2974114
5	4	31,6408	15,76252	4,145091	44,29712	63,188992	57,876571	49,586389	32,621811	24,331529
5	6	15,05665	11,67794	0,6775171	21,07959	36,752924	30,4234771	29,0688479	14,2284821	12,8738479
5	8	-35,24145	-13,56664	-2,790456	-49,47803	-72,308364	-63,886836	-58,305924	-34,557761	-29,016849
6	0	-13,65691	-15,15513	-5,715642	-19,119674	-40,63778	-37,259864	-25,82858	-18,006881	-6,575577
6	1	-1,503794	-1,99694	-3,515357	-2,1053116	-4,9986632	-7,3168538	-0,2861398	-4,8687716	2,1619424
6	2	0,8759738	1,27288	-1,315071	1,2283632	3,0877656	1,00897756	3,63911956	-0,52669458	2,10344742
6	3	-11,31209	-10,89563	0,8852151	-15,836826	-31,007516	-23,5849229	-25,3553531	-9,2956659	-11,0660961
6	4	-33,2735	-32,95331	3,095501	-46,5929	-92,653496	-69,796009	-75,967011	-26,860649	-33,031651
7	0	-118,5623	-117,1996	31,1796	-165,98722	-329,79252	-228,29376	-290,65296	-75,52647	-137,88567
7	2,2	0,6098268	4,706349	-2,653522	0,85375752	8,26195056	2,78461916	2,09156316	-2,10467788	3,20236012
7	4,5	55,50652	59,68357	-36,46664	77,700128	162,101536	89,804754	162,778034	13,469228	86,442508
7	6,7	40,19863	40,87055	-70,31976	56,278082	113,631236	18,789146	159,428666	-34,140993	106,498527

Lampiran A3

7	8.9	-44,10291	-50,44828	-104,1529	-61,744074	-133,64074	-207,524672	0,781128	-143,845519	64,460261
8	0	-60,55709	-59,84055	-3,022099	-84,779926	-168,413548	-135,531257	-129,487059	-57,52348	-51,479282
8	2.2	32,26799	34,58277	-0,3738817	45,175186	94,05402	72,9304763	73,6782397	28,6673093	29,4150727
8	4.5	60,81768	62,07844	2,274335	85,144752	172,30672	137,333991	132,785321	57,010247	52,461577
8	6.7	19,16279	15,78386	4,922553	26,827906	48,249524	43,701761	33,856655	22,169064	12,323958
8	6.9	-91,48575	-103,0165	7,570769	-128,08005	-274,6093	-205,228631	-220,370169	-74,766406	-89,907944

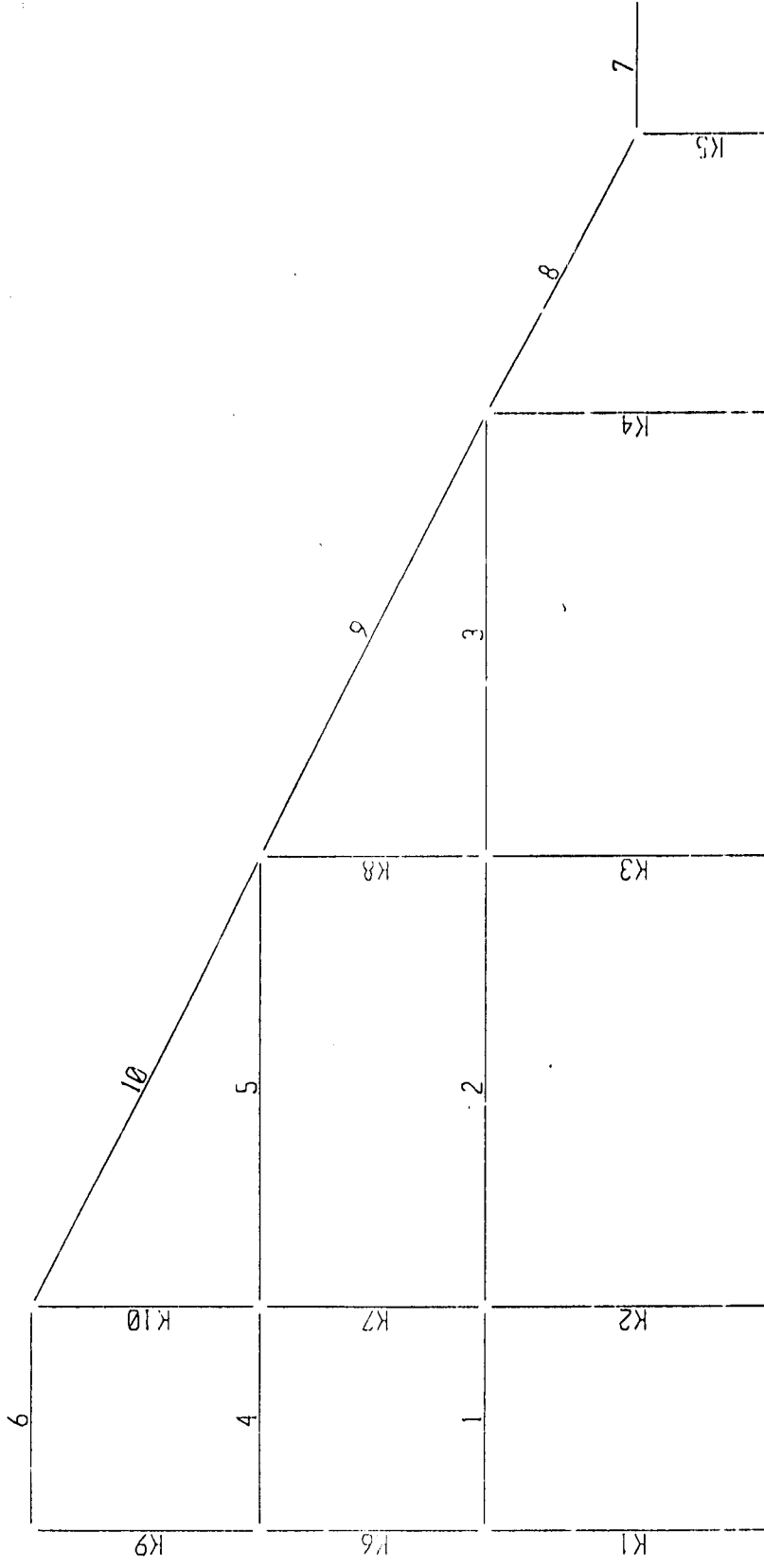

MOMEN BALOK PORTAL AS B (ANALISIS 2D)

LABEL	STATION	MD (KN.m)	ML (KN.m)	ME (KN.m)	1,4MD (KN.m)	1,2MD+1,6ML (KN.m)	1,2MD+ML+ME (KN.m)	1,2MD+ML - ME (KN.m)	0,9MD+ME (KN.m)	0,9MD-ME (KN.m)
1	0	-22,27615	-17,23346	99,47969	-31,18661	-54,304916	55,51485	-99,01506	79,431155	-102,277846
1	1	-3,108994	-2,744542	55,05022	-4,3525916	-6,12206	48,5748852	-17,0960948	52,2521254	-53,7400855
1	2	1,455705	1,952704	10,62076	2,037987	4,8711724	14,32031	37,50826	11,9308945	-18,4885969
1	3	-8,742041	-7,933393	-33,80871	-12,2388574	-23,183862	-52,225422	59,8143378	-41,6765469	7,478706
1	4	-29,255556	-27,61114	-78,23817	-40,957784	-79,284496	-140,955982	-110,610522	-104,568174	15,501915
2	0	-69,70695	-65,09706	47,89271	-97,58973	-187,803636	-100,85263	-171,12,167	-14,843545	-30,766907
2	2	19,02667	18,04209	22,37627	26,640138	51,701748	63,252764	44,016658	39,502073	27,121786
2	4	54,99784	49,61874	-3,140164	76,996976	145,387392	156,476354	144,272748	46,357892	17,567695
2	6	16,03059	15,57038	-28,0566	22,442826	44,149316	6,154488	88,960126	-14,229069	-39,476199
2	8	-75,70311	-70,04047	-54,17304	-105,984354	-202,908484	-225,057232	-203,893372	-122,305835	-0,067746
3	0	-60,26754	-55,68607	43,01517	-84,374556	-161,41876	-84,991946	-153,540308	-11,225516	-45,6628494
3	2	-2,941866	-2,92230	25,53319	-4,1186124	-8,2060648	19,080599F	-14,5038302	22,8855106	-3,719566
3	4	24,23736	22,65379	8,0512	33,932304	65,330896	59,769822	61,16941	29,864824	8,742944
3	6	18,66016	18,22996	-9,430788	26,124224	51,560128	31,191394	67,534932	7,363356	-5,926353
3	8	-17,06349	-13,38136	-26,91278	-23,888886	-41,866364	-60,770326	-64,259128	-42,269921	4,10363
4	0	-25,3435	-24,27073	30,40158	-35,4809	-133,3654	-83,2598	-107,51556	-30,15648	-32,9433726
4	1	-2,824214	-2,459918	5,894229	-3,9538996	-7,3249256	0,0452542	-6,2358551	3,3524364	2,5471383
4	2	9,379297	9,559229	0,3868803	13,1310158	26,5499228	21,2012657	25,9348544	8,8282476	5,7514482
4	3	6,820365	6,995043	-5,120469	9,548511	19,3765068	10,059012	25,807301	1,0178595	-0,3284397
4	4	-6,054343	-5,36081	-10,62782	-8,4760802	-15,8425076	-23,2538416	-20,3070376	-16,0767287	-26,565058
5	0	-41,32542	-38,26787	7,681016	-57,855588	-110,819096	-80,177353	-91,597976	-29,511862	-0,2819999
5	2	8,221129	7,07636	3,739602	11,5095806	21,1875308	20,6813168	17,1435272	11,1366181	21,119514
5	4	27,62124	25,23309	-0,2018124	38,669736	73,518432	58,1767656	62,521805	24,6573036	13,0402314
5	5	14,26491	13,38582	-4,143227	19,970874	36,541604	26,364485	38,522353	8,695192	-22,170838
5	8	-29,23785	-25,64095	-8,084641	-40,93299	-76,11094	-68,911011	-60,4287368	-34,398706	-3,359561
6	0	-12,11578	-11,9613	-0,2976332	-17,802092	-34,269032	-27,4378722	-26,4452105	-11,7418352	-0,55764175
6	1	-0,9503055	0,526154	-0,6950355	-1,3304277	-1,96221444	-2,351557	-0,5740635	-1,55031045	1,7084659
6	2	1,126056	1,03733	-1,092438	1,5764784	3,0109952	1,2961592	3,8784372	-0,0789876	-8,471583
6	3	-10,62669	-11,98252	-1,887242	-14,877366	-31,92406	-26,224388	-22,847306	-11,053861	-27,371855
6	4	-32,068855	-34,79403	-1,887242	-44,89597	-94,152708	-75,163332	-72,9215504	-30,748937	-64,071688
7	0	-73,2877	-49,14438	-0,3547396	-102,60778	-145,576246	-137,4443596	-136,8206833	-66,3136696	-37,7837864
7	0,63	-42,37614	-35,05949	-0,2689367	-59,326596	-106,946552	-86,1797947	-85,7277242	-38,4074627	-23,1796993
7	1,25	-26,05404	-23,31836	-0,1831338	-36,475656	-68,574224	-54,7663418	-54,48587712	-23,6317698	-12,171962
7	1,88	-13,7277	-9,48247	-9,73E-02	-19,21978	-31,646792	-26,05404088	25,94518204	-12,4522038	0,105568943
7	2,5	9,15E-03	7,67E-03	-1,15E-02	0,012814764	0,023253226	0,007124338	-96,5113177	-0,003289897	-56,96606804
8	0	-63,30844	-62,58823	96,52997	-88,631816	-176,111296	-42,028388	-155,814968	39,552374	-112,398311

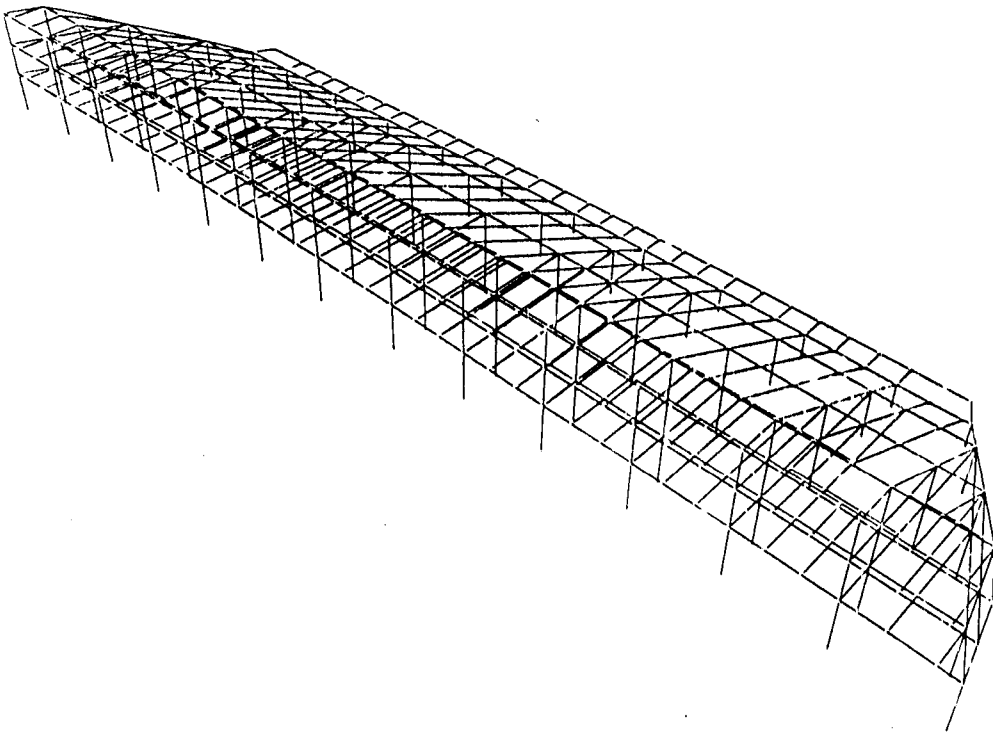

4/23/06 13:35:23

SAP2000

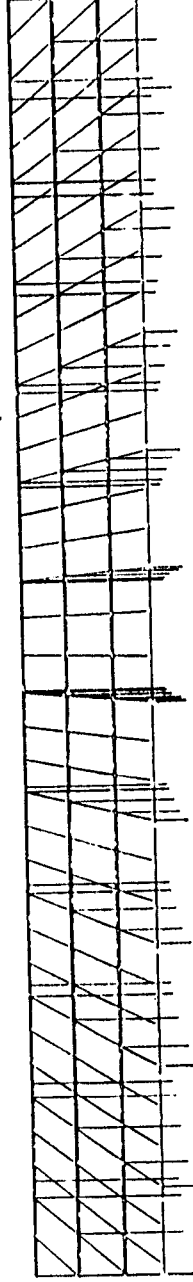

MOMEN BALOK PORTAL AS 1 (ANALISIS 3D)

LABEL	STATION	MD (KN.m)	ML (KN.m)	ME (KN.m)	1,4MD (KN.m)	1,2MD+1,6ML (KN.m)	1,2MD+ML+ME (KN.m)	1,2MD+ML - ME (KN.m)	0,9MD+ME (KN.m)	0,9MD-ME (KN.m)
141	0	-27,79377	-10,21522	183,2168	-38,911278	-49,696876	139,649056	-226,784544	158,202407	-208,231193
141	0,45	-0,6914774	-0,832127	172,0798	-0,96806836	-2,16117608	170,4179001	-173,7416999	171,4574703	-172,7021297
141	0,9	23,41913	7,969402	150,9428	32,786782	40,8540008	197,015159	-124,870441	182,020017	-139,865583
141	1,35	44,39193	16,0634	149,8058	62,148702	78,971756	219,139516	-80,472084	189,758537	-109,853063
141	1,8	62,62483	23,79291	138,6688	87,674762	113,218452	237,611506	-39,726094	155,031147	-82,306453
142	0	62,62392	23,79633	138,6782	87,673488	113,222832	237,623234	-39,733166	195,039728	-82,316672
142	0,9	86,48367	31,81571	106,4303	121,077138	154,68554	242,026414	29,165814	184,265603	-28,594937
142	1,8	97,69267	36,91909	74,18241	136,769738	176,301748	228,332704	79,967884	162,105813	13,740993
142	2,7	93,99586	37,16247	41,93452	131,594204	172,254984	191,892022	108,022982	126,530794	42,661754
142	3,6	77,64829	34,48985	9,686538	156,707606	148,361708	137,354438	117,98116	79,570099	60,196823
143	0	77,65235	34,49139	9,589586	108,71329	148,369044	137,364196	117,984224	79,577101	60,197129
143	0,9	43,56094	20,3955	-22,70152	60,985316	84,903928	49,967108	95,370148	16,503326	61,906366
143	1,8	-3,181241	3,383606	-55,05302	-4,4537374	1,5962804	-55,5269032	54,6591368	-57,9561369	52,2299031
143	2,7	-64,82922	-18,48829	-87,48452	-90,760908	-107,376328	-183,767874	-8,798834	-145,830818	29,138222
143	3,6	-139,1279	-43,27618	-191,876	-194,77906	-266,195233	-352,106323	-18,35366	-317,09111	66,66089
144	0	-135,4412	-40,5286	59,0145	-189,61768	-227,3752	-144,04354	-262,07254	-62,88256	-160,91158
144	0,75	-80,19221	-26,74531	48,08021	-112,269094	-139,023148	-74,895752	-171,056172	-24,092779	-120,253199
144	1,5	-33,33696	-14,64951	37,14592	-46,67144	-63,443566	-17,507942	-91,799782	7,142656	-67,149184
144	2,25	3,819546	-5,366218	26,21163	5,3473644	-4,0624936	25,4288672	-26,9943928	29,6492214	-22,7740386
144	3	32,5823	2,229576	15,27734	45,61522	42,6660816	56,605676	26,050996	44,60141	14,04673
145	0	32,58473	2,232081	15,27726	45,618622	42,6730056	56,611017	26,056497	44,603517	14,048997
145	0,75	47,49236	7,453506	3,392003	66,489304	68,9164416	67,836341	61,052335	46,135127	39,351121
145	1,5	54,00625	10,98743	-8,493255	75,60875	82,387388	67,301675	84,288185	40,11237	57,09888
145	2,25	50,82138	11,70886	-20,37851	71,14932	79,715832	52,316006	93,073026	25,360732	66,117752
145	3	39,24277	10,74276	-32,26377	54,939878	64,279772	25,570334	90,097874	3,054723	67,582263
146	0	39,23975	10,74013	-32,26374	54,93565	64,271908	25,56409	90,09157	3,052035	67,579515
146	0,75	15,44764	4,539403	-44,41678	21,626696	25,8002128	-21,340209	67,493351	-30,513904	58,313656
146	1,5	-15,73822	-3,34682	-56,56582	-23,433508	-25,443975	-80,004504	33,135136	-71,634218	41,505422
146	2,25	-56,62282	-14,04954	-68,72285	-82,071948	-92,826648	-153,119774	-15,674074	-121,483388	15,962312
146	3	-108,9012	-26,43777	-80,87589	-152,46168	-172,981872	-237,9951	-76,24332	-178,88697	-17,13519
147	0	-109,042	-26,97091	90,26379	-152,6588	-174,003856	-67,55752	-248,0851	-7,87401	-198,40159
147	0,75	-59,4649	-14,58627	75,47897	-83,25086	-94,695912	-10,46518	-161,42312	21,965056	-128,99738
147	1,5	-18,2816	-3,863124	60,69415	-25,59424	-28,1605184	34,867106	-86,521194	44,24371	-77,14759
147	2,25	13,20294	3,995522	45,90533	19,484116	22,2363632	65,74838	-26,07028	57,791976	-34,026684
147	3	36,29375	10,19267	31,12451	50,81125	59,860772	84,86968	22,62065	63,789885	1,539865
148	0	35,288	10,19769	31,12447	50,81172	59,873904	84,87976	22,63082	63,79267	1,54373
148	0,75	49,60059	13,22414	16,38445	69,440826	80,679332	89,129298	56,360398	61,024981	28,256081

148	1,5	54,50943	14,56309	1,644418	76,313202	88,71226	81,618824	78,329988	50,702905	47,414069
148	2,25	49,71951	13,08954	-13,09561	69,607314	80,606676	59,657342	85,848562	31,651949	57,643169
148	3	36,53585	9,928493	-27,83564	51,15019	59,7286088	25,935873	81,607153	5,046625	60,717905
149	0	36,53075	9,922677	-27,83573	51,14305	59,7131832	25,923847	81,595307	5,041945	60,713405
149	0,75	13,91361	3,908233	-42,42781	19,479054	22,9495048	-21,823245	63,032375	-28,905561	54,950059
149	1,5	-17,09729	-3,793711	-57,0199	-23,936206	-26,5866856	-81,330359	32,709441	-72,407461	41,632339
149	2,25	-57,80693	-14,30816	-71,61198	-80,929702	-92,281372	-155,288456	-12,064496	-123,638217	19,585743
149	3	-106,9103	-26,5101	-86,20406	-149,67442	-170,70852	-241,00652	-68,5984	-182,42335	-10,01521
150	0	-106,7246	-26,31874	85,11484	-149,41444	-170,179504	-69,27342	-239,5031	-10,9373	-181,16699
150	0,75	-57,89248	-14,48785	70,91402	-81,049472	-92,651536	-13,044806	154,872846	18,810788	-123,017252
150	1,5	-17,45409	-4,34445	56,71319	-24,435726	-27,696028	31,423832	-82,002548	41,004509	-72,421871
150	2,25	13,28555	2,986448	42,51237	18,59977	20,7209768	61,441478	-23,583262	54,469365	-30,555375
150	3	35,63144	8,629846	28,31154	49,884016	56,5654815	79,699114	23,076034	60,379836	3,756756
151	0	35,63653	8,635349	28,31168	49,891142	56,5803944	79,710865	23,087505	60,384557	3,761197
151	0,75	48,60589	11,5691	14,08305	68,048246	76,837628	83,979218	55,813118	57,528351	29,662251
151	1,5	53,1815	12,81535	-0,1455901	74,4541	84,32226	76,4675399	76,7787301	47,7177699	48,0089301
151	2,25	48,05637	11,2491	-14,37421	67,281718	75,668604	54,544934	83,293354	28,878323	57,626743
151	3	34,54148	7,995355	-28,60284	48,358072	54,242344	20,842291	78,047971	2,484492	59,690172
152	0	34,53725	7,990516	-28,60267	48,35215	54,295256	20,832546	78,037886	2,480855	59,686195
152	0,75	11,31125	1,758061	-42,61051	15,83575	16,3863976	-27,478949	58,142071	-32,630385	52,990635
152	1,5	-20,3085	-6,161894	-57,01835	-28,4319	-34,292304	-87,550444	26,486256	-75,296	38,7407
152	2,25	-61,627	-16,89435	-71,2262	-86,2778	-100,98336	-162,07295	-19,62055	-126,6905	15,7619
152	3	-111,3393	-29,3143	-85,43404	-155,87502	-180,51004	-248,3555	-77,48742	-185,63941	-14,77133
153	0	-111,4087	-29,37593	84,88347	-155,97218	-180,691928	-78,1829	-247,94984	-15,38436	-185,1513
153	0,75	-60,19486	-15,80412	70,82379	-84,272804	-97,520424	-17,214162	-158,861742	16,648416	-124,999164
153	1,5	-17,37476	-3,9198	56,76411	-24,324664	-27,121392	31,994598	-81,533622	41,126826	-72,401394
153	2,25	15,74658	5,152016	42,70444	22,045212	27,1391216	66,752352	-18,656528	56,876362	-28,532518
153	3	40,47418	12,53633	28,64476	56,663852	69,627144	89,750106	32,460588	65,071522	7,782002
154	0	40,47718	12,54021	28,64483	56,668052	68,636952	63,757656	32,467996	55,074292	7,784632
154	0,75	53,97114	15,6831	14,49879	75,559596	89,858328	94,947258	65,949678	63,072816	34,075236
154	1,5	59,07135	17,1385	0,3527553	62,69989	56,30722	88,3768753	87,6713647	53,5169703	52,8114597
154	2,25	54,47281	15,78139	-13,79328	76,261934	90,517596	67,355482	94,942042	35,232249	62,818809
154	3	41,46552	12,78678	-27,93932	58,072728	70,155472	34,574084	90,452724	9,393148	65,271782
155	0	41,47785	12,73315	-27,93925	58,06898	70,14646	34,56732	90,44582	9,390815	65,269315
155	0,75	17,18471	5,396006	-42,10465	24,058594	29,2552616	-16,987032	68,122348	-26,638451	57,570929
155	1,5	-15,50218	-3,628639	-56,27013	-21,703052	-24,4084394	-78,501385	34,038875	-70,222092	42,318168
155	2,25	-57,88782	-15,46578	-70,43558	-81,042948	-94,210632	-155,366744	-14,495584	-122,534618	-18,336542
155	3	-108,6672	-28,99043	-84,60101	-152,13408	-176,785328	-243,99208	-74,79006	-182,40149	-13,19847
156	0	-107,7321	-28,55954	85,08175	-150,82494	-174,973784	-72,75631	-242,91981	-11,87714	-182,04064
156	0,75	-59,29509	-16,37661	70,78378	-83,013126	-97,356684	-16,746938	-158,314498	17,418199	-124,149361
156	1,5	-19,25184	-5,881183	59,4958	-26,952576	-32,5121009	27,502409	-85,463191	39,159144	-73,812456

156	2,25	11,09267	1,801744	42,18782	15,529738	16,1939544	57,300766	-27,074872	52,171223	-32,204417
157	3	33,04782	7,802012	27,88991	46,256948	52,1406032	75,339116	19,559435	57,62895	1,649238
157	0	45,0572	10,66994	13,50548	63,08008	71,140544	78,24406	51,2331	57,632543	1,553128
157	1,5	48,67284	11,85038	-0,8789402	68,141976	77,368016	69,3788478	71,1367282	54,05655	27,046
157	2,25	42,58972	10,21821	-15,26336	59,625608	67,45696	46,062614	76,589334	42,9266153	44,6844952
157	3	26,11286	6,898742	-29,64779	39,358004	44,7734192	10,986384	70,281964	23,067365	53,594108
158	0	28,10803	6,893479	-29,04772	39,351242	44,7592024	10,975395	70,270835	-4,350453	54,944947
158	0,75	3,922996	0,6545353	-44,03475	5,4921944	5,75485328	-38,6726185	49,3968815	-40,5040536	47,5654464
158	1,5	-28,65579	-7,271936	-58,42178	-40,118106	-46,0219576	-100,080634	16,762926	-84,211591	32,531563
158	2,25	-70,93332	-18,01085	-72,80881	-99,306648	-113,937344	-175,939644	-30,322024	-136,648795	8,966822
158	3	-121,6046	-30,43729	-87,19581	-170,24644	-194,625184	-263,55865	-89,16697	-196,63955	-22,2483
159	0	-124,9652	-31,35061	81,15575	-174,95268	-200,120416	-100,1543	-262,4658	-31,31353	-193,62533
159	0,83	-64,24527	-16,1968	67,68456	-89,943378	-103,009204	-25,606564	-160,975684	9,863217	-125,505303
159	1,67	-13,88678	-3,126288	54,21336	-19,441492	-21,6661552	34,422936	-74,003784	41,715255	-66,711482
159	2,50	24,49817	6,472074	40,74216	34,297438	39,7531224	76,612038	-4,872282	62,79053	-18,693807
159	3,33	52,52069	13,98714	27,27097	73,528966	85,404252	104,282938	49,740998	74,53955	9,997651
160	0	52,52589	13,9935	27,27105	73,536246	85,420668	104,295618	49,753518	74,54435	20,002251
160	0,83	68,87651	17,80964	13,70338	96,427114	111,147235	114,164832	86,758072	75,992239	48,285479
160	1,67	74,86469	19,54248	0,1357141	104,810566	121,105555	109,5158221	109,2443939	67,513935	67,2425063
160	2,50	68,87933	17,80317	-13,43195	96,431062	111,140266	87,026416	113,890316	48,55944	75,423347
160	3,33	52,53153	13,98057	-26,99962	73,544142	85,406748	50,018786	104,018026	20,27875	74,277957
161	0	52,52632	13,97422	-26,99953	73,536848	85,390336	50,06274	104,005334	20,274155	74,273218
161	0,83	24,50572	6,452519	-40,55877	34,308008	39,7308944	-4,699387	76,418153	-18,503622	62,613918
161	1,67	-13,87796	-3,152595	-54,11802	-19,429144	-21,697704	-73,924167	34,311873	-66,608164	41,627856
161	2,50	-64,23588	-16,23007	-67,67726	-89,930232	-103,051168	-160,990386	-25,635866	-125,489552	9,864968
161	3,33	-124,9569	-31,39096	-81,23651	-174,93966	-227,174321	265,57623	-100,10273	-193,69772	-31,2247
162	0	-121,6138	-30,39567	86,55805	-170,25932	-194,569632	-89,77418	-262,89028	-22,89437	-196,01047
162	0,75	-70,94103	-17,97565	72,33935	-99,317442	-113,890555	-30,766036	-175,444136	8,492123	-136,185977
162	1,5	-28,66197	-7,243537	58,12005	-40,126758	-45,9840232	16,482149	-99,757951	32,324277	-83,915823
162	2,25	3,918344	0,6762799	43,90105	5,4856815	5,78405904	49,2793417	-38,5227583	47,4275595	-40,3745404
162	3	28,10491	6,908595	29,68205	39,346574	44,779544	70,316537	10,952437	54,976455	-4,387631
163	0	28,10974	6,913857	29,68211	39,353636	44,7938552	70,327675	10,953415	54,980855	-4,383364
163	0,75	42,58804	10,22671	15,38119	59,623256	67,468384	76,713536	45,951178	53,710416	22,848056
163	1,5	48,6726	11,85207	1,080224	68,14164	77,370432	71,339414	69,178966	44,385564	42,725116
163	2,25	45,0584	10,68492	-13,22073	63,08176	71,133952	51,51427	77,95573	27,33183	53,77329
163	3	33,05046	7,790272	-27,52168	46,270644	52,1249872	19,929144	74,972504	2,223734	57,267094
164	0	33,04606	7,795432	-27,52158	46,264484	52,119632	19,919124	74,962284	2,219874	57,263034
164	0,75	11,0968	1,783403	-41,82706	15,53552	16,1696048	-26,727497	56,926623	-31,83954	51,81418
164	1,5	-19,24621	-5,906127	-56,13255	-26,944694	-32,5452552	-85,134129	27,130971	-73,454135	38,810561
164	2,25	-59,28797	-16,40816	-70,43803	-83,003158	-97,39662	-157,991754	-17,115594	-123,797203	17,078857

164	3	-107,7235	-28,59769	-84,7435	-150,8129	-175,024504	-242,5094	-73,12238	-181,69468	-12,20764
165	0	-108,6776	-28,9457	83,33135	-152,14864	-176,72624	-76,02743	-242,69021	-14,47845	-181,14123
165	0,75	-57,89627	-15,42954	69,44015	-81,054776	-94,162788	-15,454874	-154,345254	17,333547	-121,546633
165	1,5	-15,50874	-3,600886	55,549	-21,712236	-24,3719056	33,337626	-77,760374	41,591134	-69,506866
165	2,25	17,18005	5,415272	41,6578	24,05207	29,2804952	67,689132	-15,626468	57,119845	-26,195755
165	3	41,47508	12,74393	27,76661	58,065112	70,160334	90,280636	34,747416	65,094182	9,560962
166	0	41,47775	12,74756	27,76668	58,06885	70,165396	90,28754	34,75418	65,096655	9,563295
166	0,75	54,47188	15,78351	13,77975	76,260632	90,619872	54,929516	67,370016	62,804442	35,244942
166	1,5	59,07226	17,13197	-0,207174	82,701164	98,297864	87,811508	88,225856	52,95786	53,372208
166	2,25	53,97389	15,66793	-14,1941	75,553446	89,837356	66,242498	94,630698	34,382401	62,770601
166	3	40,48177	12,51638	-28,18103	56,674478	68,604332	32,913474	89,275534	8,252563	64,614623
167	0	40,47877	12,5125	-28,18093	56,670278	68,594524	32,906094	89,267954	8,249963	64,611823
167	0,75	15,75318	5,119556	-42,2056	22,054452	27,0951056	-18,182228	66,228972	-28,027739	56,383462
167	1,5	-17,36617	-3,960888	-56,23028	-24,312638	-27,1768248	-81,030572	31,429988	-71,859833	40,600727
167	2,25	-60,18426	-15,85383	-70,25496	-84,257964	-97,58724	-158,329902	-17,819982	-124,420794	16,039126
167	3	-111,3961	-29,43426	-84,27964	-155,95454	-180,770168	-247,38924	-78,82996	-184,53613	-15,97685
168	0	-111,3448	-29,29386	83,31025	-155,88272	-180,483936	-79,59737	-246,21787	-16,90007	183,52057
168	0,75	-61,63231	-16,87165	69,52381	-85,285234	-100,953412	-21,306612	-160,354232	14,054731	-124,992889
168	1,5	-20,31355	-6,136933	55,73737	-28,43897	-34,1953528	25,224177	-85,250563	37,455175	-74,019565
168	2,25	11,30646	1,785261	41,95093	15,829044	16,4242016	57,303963	-26,597897	52,126744	-31,775116
168	3	34,53272	8,019996	28,16449	48,345809	54,2712576	77,62375	21,29477	59,243938	2,914958
169	0	34,53696	8,024833	28,16445	48,351744	54,2840848	77,633675	21,304695	59,247754	2,918774
169	0,75	48,05378	11,28094	14,33223	67,275292	75,71404	83,277706	54,613246	57,580632	28,916172
169	1,5	53,17685	12,84954	0,499679	74,44759	84,371484	77,1617279	76,1617921	48,3591329	47,3591971
169	2,25	48,60117	11,60564	-13,33229	68,041638	76,890428	56,594754	83,259334	30,408763	57,073343
169	3	35,63174	8,674243	-27,16455	49,884436	56,6368768	24,267771	78,596851	4,904006	59,233126
170	0	35,62666	8,66874	-27,16457	49,877324	56,621976	24,256162	78,585302	4,899424	59,228564
170	0,75	13,28041	3,028235	-40,91217	18,592574	20,781668	-21,947443	59,876897	-28,959801	52,864539
170	1,5	-17,45958	-4,299769	-54,65976	-24,443412	-27,8311264	-79,911025	29,408495	-70,373382	38,946138
170	2,25	-57,89833	-14,44027	-68,40735	-81,057662	-92,582428	-152,325616	-15,510916	-120,515847	16,298853
170	3	-106,7308	-26,26828	-82,15494	-149,42312	-170,106208	-236,50018	-72,1903	-178,21266	-13,90278
171	0	-106,9404	-26,36004	85,6442	-1,971556	-170,504544	-69,04432	-240,33272	-10,60216	-181,89056
171	0,75	-57,82973	-14,21545	71,01265	-80,961622	-92,140356	-12,598476	-154,623776	18,965893	-123,059407
171	1,5	-17,11282	-3,758354	55,3811	-23,957948	-25,5487504	32,087362	-80,674838	40,979562	-71,782638
171	2,25	13,90532	3,886241	41,74955	19,467462	22,9043816	62,322187	-21,176913	54,264347	-29,234753
171	3	36,52974	9,843336	27,11801	51,141636	59,580256	80,727034	26,561014	59,994776	5,758756
172	0	36,53484	9,849159	27,11817	51,148776	59,6004624	80,809137	26,572797	59,999526	5,763186
172	0,75	49,72718	12,95252	12,41485	69,618052	80,396648	85,039986	60,210286	57,169312	32,339612
172	1,5	54,52578	14,36839	-2,288461	76,336092	86,42036	77,510865	82,087787	46,784741	51,361663
172	2,25	49,62562	12,97175	-16,99178	69,475868	80,305544	55,530714	89,514274	27,671278	61,654838
172	3	36,33172	9,887511	-31,69509	50,864408	59,4182416	21,790585	85,180765	1,003458	64,393638

173	0	35,32746	9,882586	-31,69488	50,858444	59,4050896	21,780658	85,170418	0,999834	64,389594
173	0,75	13,24824	3,626966	-46,48021	18,547536	21,7010336	-26,955356	66,005064	-34,556794	58,403626
173	1,5	-18,22473	-4,316154	-81,26553	-25,514622	-28,7752224	-87,45136	35,0797	-77,667787	44,863273
173	2,25	-59,39645	-15,07177	-76,05085	-83,15503	-95,390572	-162,39836	-10,29666	-129,507655	22,594045
173	3	-108,9619	-27,51489	-90,83617	-152,54666	-174,778104	-249,10534	-67,433	-188,90188	-7,22954
174	0	-108,8277	-27,01601	75,43215	-152,35878	-173,818856	-82,1771	-233,0414	-22,51278	-173,37708
174	0,75	-58,56337	-14,3333	64,91563	-81,988718	-93,20934	-19,693724	-149,524984	12,208597	-117,622663
174	1,5	-16,6928	-3,33612	54,3991	-23,36992	-25,372352	31,02962	-77,76858	39,37558	-69,42262
174	2,25	15,47902	4,844575	43,88257	21,670628	26,326144	67,301969	-20,463171	57,813688	-25,951452
174	3	39,25709	11,33977	33,36605	54,959926	65,25214	91,814328	25,082228	68,697431	1,965331
175	0	39,26014	11,34238	33,36613	54,964196	65,259992	91,820688	25,088428	68,700256	1,967996
175	0,75	50,8214	12,5529	22,74562	71,14996	81,138144	96,32659	50,83535	68,48488	22,89364
175	1,5	53,98891	12,16069	12,1251	75,584474	84,243796	89,072482	64,822282	60,715119	36,464919
175	2,25	47,45767	8,913591	1,504585	66,440738	71,2109496	67,36738	64,35821	44,216488	41,207318
175	3	32,53268	3,97899	-9,115931	45,545752	45,4056	33,902275	52,134137	20,163481	38,395343
176	0	32,53028	3,976495	-9,11563	45,542392	45,398728	33,897001	52,122561	20,161422	38,393082
176	0,75	3,735848	-3,339811	-19,34244	5,2301872	-0,86068	-18,1992334	20,4856466	-15,9901768	22,7047032
176	1,5	-33,45234	-12,34362	-29,56905	-46,833276	-55,8926	-82,055478	-22,917378	-59,676156	-0,538056
176	2,25	-80,33927	-24,15992	-39,79565	-112,474978	-135,062996	-160,362694	-80,771394	-112,100993	-32,509693
176	3	-135,6199	-37,66373	-50,02226	-189,86786	-223,005848	-250,42987	-150,38535	-172,08017	-72,03565
177	0	-139,3335	-39,59005	124,7665	-195,0669	-240,54428	-82,02375	-321,557342	-0,63365	-250,16665
177	0,9	-64,95827	-17,22983	89,36693	-50,941578	-105,517652	-5,812824	-184,546684	30,904487	-147,829373
177	1,3	-3,233815	2,214389	53,96733	-4,527341	-10,33724	52,301141	-55,633519	51,0568965	-56,877635
177	2,7	43,58485	16,79861	18,56772	61,01879	79,179596	87,66815	50,53271	57,794085	20,658645
177	3,6	77,75275	28,46682	-16,83188	108,85385	138,850212	104,93824	138,602	53,145595	86,809355
178	0	77,74868	28,46543	-16,82786	108,848152	138,843104	104,935986	138,591706	53,145952	86,801672
178	0,9	94,12089	31,90084	-54,86499	131,769246	163,986412	89,980918	199,710898	29,843811	139,573791
178	1,8	97,84233	32,42025	-92,90211	136,979262	169,283196	56,928936	242,733156	-4,844013	180,960207
178	2,7	86,65797	28,07965	-130,9392	121,321158	148,917004	1,130014	263,008414	-52,947027	208,931373
178	3,6	62,82285	20,82306	-168,9764	87,952004	108,704328	-72,765908	265,186892	-112,435826	225,516974
179	0	62,82378	20,81955	-168,965	87,953292	108,695816	-72,766914	265,173086	-112,423598	225,506402
179	0,45	44,5719	14,10572	-176,5601	62,40066	76,055432	-110,5681	246,1521	-138,44539	218,67481
179	0,9	23,58014	7,027399	-188,1552	33,012196	39,5400064	-152,831633	223,478767	-166,933074	209,377326
179	1,35	-0,5494385	-0,7584527	-197,7502	-0,7692139	-1,87285052	-199,1679789	196,3324211	-198,2446947	197,2557054
179	1,8	-27,67071	-9,125867	-207,3453	-38,738994	-47,8062392	-249,676019	165,014581	-232,248939	182,441661
180	0	-35,02395	-13,52797	101,1162	-49,03353	-63,673492	45,55949	-156,67291	69,594645	-132,637755
180	0,45	-7,516327	-3,943007	94,90356	-10,528578	-15,3284036	81,9409606	-107,8661594	88,1388857	-101,6682543
180	0,9	16,99961	5,060396	88,69095	23,799454	28,4961656	114,150878	-63,231022	103,990599	-70,391901
180	1,35	36,37773	13,35627	92,47832	53,728822	67,423328	141,837866	-23,065774	117,018277	-47,938363
180	1,8	57,01596	21,28764	76,26571	79,822344	102,479376	165,972502	13,441082	127,580074	-24,951346
181	0	57,01563	21,2912	76,27116	79,821882	102,484676	165,981116	13,438796	127,585227	-24,957093

181	0,9	82,49384	30,45688	59,24394	115,491376	147,723616	188,693428	70,205548	133,486396	15,000516
131	1,0	95,32129	36,70656	42,21672	133,449306	173,116044	193,308828	108,875388	128,005881	43,572441
181	2,7	93,24295	38,09624	25,1895	130,54013	172,845524	175,17728	124,79828	109,108155	58,729155
181	3,6	78,51384	36,56992	8,162275	109,919376	152,72848	138,948903	122,624253	78,824731	62,500181
182	0	78,51833	36,57184	8,164908	109,925662	152,73694	138,958744	122,628928	76,831405	62,501589
182	0,9	43,33548	21,31656	-9,958184	60,669672	86,109072	63,360952	83,27732	29,043748	48,960116
182	1,8	-4,49812	3,145267	-28,08128	-6,297368	-0,3653166	-30,333757	-0,828803	-32,129588	24,032972
182	2,7	-67,23752	-19,88602	-46,20437	-94,132528	-112,502656	-146,775414	-54,366674	-106,718138	-14,309398
182	3,6	-142,6277	-45,83331	-64,32746	-199,57678	-244,486536	-281,31401	-152,65909	-192,69239	-64,03747
183	0	-138,7307	-42,11917	-29,73229	-194,22298	-233,867512	-178,86372	-238,3280	-95,12534	-154,58992
183	0,75	-79,32516	-26,36853	23,82502	-111,055224	-137,37984	-97,733702	-145,383742	-47,567624	-95,217664
183	1,5	-28,31333	-12,30538	17,51775	-39,638662	-53,624604	-28,363626	-64,199126	-7,564247	-43,399747
183	2,25	12,99975	-1,054736	12,01048	18,19965	13,9121224	26,555444	2,534484	23,710255	-0,310705
183	3	45,91508	8,50841	6,103216	64,286712	68,716352	69,714522	57,50809	47,430388	35,223956
184	0	45,92092	8,511189	6,10327	64,289288	68,7230064	69,719563	57,513023	47,432098	35,225559
184	0,75	57,46093	11,88555	0,1959863	80,445302	87,969993	81,0346523	80,6426797	51,9108233	51,5188507
184	1,5	60,60719	13,57241	-5,711297	84,850066	94,444484	80,589741	92,012335	48,835174	60,257768
184	2,25	54,0047	12,44678	-11,61058	75,67658	84,780486	65,99384	88,931	37,03065	60,26781
184	3	39,10846	9,63364	-17,52586	54,751844	62,34395	39,037932	74,089652	17,671754	52,723474
185	0	39,10818	5,632137	-17,52617	54,751452	62,3412352	39,035783	74,088123	17,671192	52,723532
185	0,75	9,68564	-9,76E-02	-23,68699	13,5611896	11,4676713	-12,16074164	35,21323836	-14,9690824	32,4048976
185	1,5	-28,12881	-11,51489	-29,8478	-39,380304	-52,178396	-75,117262	-15,421662	-55,163729	4,531871
185	2,25	-75,64292	-25,74466	-36,00862	-105,900088	-131,96296	-152,524784	-80,507544	-104,087248	-32,070008
185	3	-131,5508	-41,66193	-42,16943	-184,17112	-224,520048	-241,69232	-157,35346	-160,56515	-76,22629
186	0	-132,3582	-43,2554	45,93918	-185,30148	-228,03848	-156,14606	-248,02442	-73,1832	-165,06156
186	0,75	-72,15019	-23,0539	38,44853	-101,010266	-123,466468	-71,185598	-148,082658	-26,486641	-103,393701
186	1,5	-20,32597	-4,53998	30,95788	-28,470358	-31,5670008	2,014818	-59,900942	12,655507	-49,260253
186	2,25	21,7795	11,1616	23,46723	30,4513	43,95396	60,76423	13,82977	43,06878	-3,86566
186	3	55,50123	25,17561	15,97658	77,701722	106,862452	107,753666	75,800506	65,927687	33,974527
187	0	55,49565	25,176	15,97635	77,69951	106,86118	107,75193	75,79923	65,926035	33,973335
187	0,75	67,84224	27,37613	8,486425	94,979136	125,212496	117,273243	100,300393	69,544441	52,571591
187	1,5	71,79108	27,88675	0,9964967	100,507512	130,771296	115,0345427	112,0415493	65,6084987	63,6154753
187	2,25	66,04118	25,58887	-6,493432	92,457652	120,191608	98,344854	111,331718	52,94363	65,930494
187	3	51,89752	21,60149	-13,98336	72,656528	96,839408	69,895154	97,861874	32,724408	50,691128
188	0	51,89922	21,60125	-13,98345	72,658908	96,841064	69,896864	97,863761	32,725648	60,692748
188	0,75	16,37487	5,798905	-21,47372	22,924818	28,928092	3,975029	46,922469	-6,736337	36,211103
188	1,5	-27,54324	-11,69094	-28,96399	-38,560536	-51,757392	-73,706818	-15,778838	-53,752906	-4,175074
188	2,25	-81,16009	-31,99328	-36,45426	-113,624126	-148,581356	-165,839648	-82,931128	-109,498341	-36,589821
188	3	-143,1707	-53,98312	-43,94453	-200,43898	-258,17832	-269,73249	-181,84343	-172,79816	-84,9091
189	0	-142,8634	-53,69037	45,19788	-200,00876	-257,340672	-179,92857	-270,32433	-33,37916	-173,77454
189	0,75	-60,74199	-31,80981	37,67073	-113,038786	-147,786084	-91,029468	-166,370928	-34,997061	-110,338521

189	1,5	-27,01431	-11,61676	30,14358	-37,620034	-51,003988	-13,890352	-74,177512	5,33075	-54,456459
189	2,25	17,01462	5,763793	22,61643	23,820466	29,6396128	46,797767	3,564907	37,929522	-7,303272
189	3	52,6498	21,45685	15,08928	73,70972	97,51072	99,72589	69,54733	62,474	32,29554
190	0	52,64706	21,45626	15,08955	73,705884	97,506488	99,722282	69,543182	62,471924	32,292804
190	0,75	66,90238	25,33503	7,562209	93,663332	120,818904	113,180095	99,055677	67,774351	52,649933
190	1,5	72,76395	27,52629	3,49E-02	101,86953	131,358804	114,877895	114,808165	55,52242002	65,45268997
190	2,25	68,92677	26,90506	-7,492478	96,497478	125,76022	102,124706	117,109662	54,541615	59,525571
190	3	56,69584	24,59632	-15,01982	79,374176	107,38912	77,611508	107,651148	36,006436	66,046076
191	0	56,69806	24,59645	-15,01954	79,377284	107,391992	77,614582	107,653662	36,008714	66,047794
191	0,75	23,06956	10,47504	-22,54661	32,325384	44,467536	15,635902	60,729122	-1,766006	43,327214
191	1,5	-18,91269	-5,33866	-30,07369	-26,477766	-31,2294136	-58,102784	2,044596	-47,095111	13,052269
191	2,25	-70,61369	-23,95527	-37,60076	-98,859166	-123,06486	-146,292458	-71,090933	-101,153061	-25,951561
191	3	-130,7084	-44,26418	-45,12784	-182,99176	-227,672768	-246,2421	-155,98642	-162,7654	-72,50972
192	0	-128,7504	-42,8921	44,11249	-180,25056	-223,12784	-153,28009	-241,50507	-71,76287	-159,98785
192	0,75	-74,06404	-26,46073	36,80027	-103,689656	-131,214016	-78,537308	-152,137848	-29,857366	-103,457906
192	1,5	-27,77143	-11,71686	29,48805	-38,680002	-52,072692	-15,554526	-74,530626	4,493763	-54,482337
192	2,25	8,822423	0,2145102	22,17583	12,3513922	10,93012392	32,9772478	-11,3744122	30,1160107	-14,2356493
192	3	37,02253	10,45838	14,8636	51,831542	61,160444	69,749016	40,021816	48,183877	18,456677
193	0	37,02618	10,46269	14,86366	51,836652	61,17172	69,757766	40,030446	48,187222	18,459902
193	0,75	51,85915	14,57142	7,437435	72,60281	85,545252	84,239635	69,364965	54,11067	39,2356
193	1,5	58,29836	16,99265	1,12E-02	81,617704	97,146272	86,9618992	86,9947417	52,47973183	52,45731617
193	2,25	55,03883	16,60139	-7,41502	77,054362	92,60882	75,232966	90,063006	42,119927	56,949967
193	3	43,38554	14,52262	-14,84125	60,739756	75,29884	51,744018	81,426518	24,205736	53,888236
194	0	43,38144	14,51801	-14,84119	60,734016	75,296544	51,734548	81,416928	24,202106	53,884486
194	0,75	15,78281	4,217659	-22,25464	22,095934	25,6876264	0,902391	45,411671	-8,050111	36,459169
194	1,5	-20,20958	-7,770193	-29,6681	-28,293412	-36,6838048	-61,989789	-2,353589	-47,856722	11,479478
194	2,25	-65,90071	-22,57055	-37,08155	-92,260994	-115,193732	-138,732952	-64,569852	-96,392189	-22,229089
194	3	-119,9656	-39,0594	-44,495	-167,57984	-206,47616	-227,53612	-138,54612	-152,48204	-63,48204
195	0	-119,7989	-39,29154	44,80494	-167,71846	-206,625144	-138,24528	-227,85516	-53,01407	-152,62395
195	0,75	-65,24338	-21,7418	37,29616	-91,340732	-113,078936	-62,737696	-137,330016	-21,422882	-96,015202
195	1,5	-19,08162	-5,879554	29,78738	-26,714268	-32,3052304	1,009882	-52,564878	12,613922	-46,960338
195	2,25	17,39139	7,17019	22,2786	24,33946	32,32972	50,306458	5,749258	37,921051	-6,635349
195	3	45,45065	18,53243	14,76983	63,63091	84,192668	87,84304	58,30333	55,875415	26,135755
196	0	45,45146	18,5324	14,76991	63,632044	84,196536	87,845902	58,306082	55,676224	26,136404
196	0,75	56,88469	20,90417	7,112073	79,63826	101,70818	96,277751	82,053605	58,308204	44,084058
196	1,5	59,92396	21,5866	-0,547628	83,893544	106,447312	92,9495892	94,0411146	53,3858012	54,4773268
196	2,25	53,26459	19,45664	-8,203599	74,570426	95,047972	75,170449	91,577647	39,734532	56,14173
196	3	38,21146	15,63897	-15,86144	53,496044	70,876144	45,631282	77,554162	18,528874	50,251754
197	0	38,21111	15,63749	-15,86139	53,495554	70,875316	45,629432	77,352212	18,528609	50,251389
197	0,75	6,481173	2,824525	-23,31726	9,0736422	12,2966476	-12,7153274	33,9191926	-17,4842043	29,1503157
197	1,5	-33,64252	-11,67594	-30,77314	-47,099528	-59,052528	-82,820104	-21,273824	-61,051408	0,494872

197	2,25	-83,46495	-26,98891	-35,22902	-116,85093	-146,540196	-167,37587	-50,91783	-113,347475	-36,889435
197	3	-141,6811	-47,58538	-45,6849	-198,35354	-246,800328	-263,6916	-172,3218	-173,19789	-81,82809
198	0	-145,4653	-49,02553	43,20986	-203,65142	-252,999208	-180,37403	-255,79375	-87,70891	-174,12863
198	0,83	-77,23969	-27,40597	35,0839	-108,135566	-136,54358	-84,013698	-155,181498	-33,431821	-105,599621
198	1,67	-19,37653	-7,877706	28,95795	-27,127142	-35,8561656	-2,171592	-60,087492	11,519073	-46,396827
198	2,50	26,51311	8,182408	21,832	37,116354	44,9075848	61,83014	18,16614	45,693799	2,029799
198	3,33	62,0403	22,15923	14,70604	86,85642	109,903128	111,31363	81,90155	70,54231	41,13023
199	0	62,0419	22,16249	14,70612	86,85866	109,910264	111,31889	81,90665	70,54383	41,13159
199	0,83	78,3905	25,97608	7,359473	109,7467	135,630328	127,404153	112,685207	77,910923	63,191977
199	1,67	84,37656	27,70538	1,25E-02	118,127324	145,5822	128,9711994	128,9455446	75,95182138	75,92616662
199	2,50	78,38929	25,96452	-7,333818	109,745006	135,61038	112,69785	127,365486	63,216543	77,884179
199	3,33	62,03947	22,13937	-14,68046	86,855258	109,870356	81,906274	111,267194	41,155063	70,515983
200	0	62,03788	22,1361	-14,58039	86,853032	109,863216	81,901166	111,261946	41,153702	70,514482
200	0,83	26,50825	8,147804	-2,79715	37,11155	44,8463864	18,160554	61,754654	2,060275	45,654375
200	1,67	-19,38444	-7,92391	-25,91392	-27,138216	-35,939584	-60,099158	-2,271318	-46,355316	11,467924
200	2,50	-77,25137	-27,45799	-36,03068	-108,151918	-136,650429	-156,200314	-84,138954	-105,556913	-33,495553
200	3,33	-145,4814	-49,09547	-43,14745	-203,67396	-253,130443	-296,82061	-180,5237	-174,08071	-87,78581
201	0	-141,6617	-47,91234	45,9533	-198,32638	-246,653784	-171,95308	-253,85958	-81,54223	-173,44883
201	0,75	-83,44884	-28,92451	36,42765	-116,828375	-146,417824	-90,620468	-167,502768	-36,661536	-113,546606
201	1,5	-33,62872	-11,62419	35,932	-47,081608	-58,954368	-21,047854	-82,911654	0,665252	-61,198748
201	2,25	6,490644	2,863636	23,42135	9,0869016	12,3705904	34,073588	-12,7889412	25,2825296	-17,5797704
201	3	39,21726	15,66396	15,9107	53,504164	70,923048	77,435372	45,513972	50,306234	18,484834
202	0	38,21761	15,66543	15,91075	53,504654	70,92582	77,437312	45,515812	50,306599	18,485099
202	0,75	53,26744	19,4699	2,207984	74,574416	95,072768	91,598812	75,182844	50,14868	39,732712
202	1,5	59,92353	21,58687	0,5052146	83,892942	106,447228	94,0003206	92,9898914	54,4363916	53,4259624
202	2,25	56,88086	20,89135	-7,197555	79,633204	101,683192	81,950827	96,345937	43,995219	58,390329
202	3	45,44445	18,50832	-14,90032	63,62223	84,146652	58,14134	87,94198	25,999685	55,800325
203	0	45,44363	18,50651	-14,90025	63,621082	84,142772	58,138616	87,939116	25,999011	55,799517
203	0,75	17,37102	7,131487	-22,45278	24,319428	32,2556032	5,523931	50,429491	-6,818862	38,086698
203	1,5	-19,09534	-5,931037	-30,00531	-26,733476	-32,4040672	-58,850755	1,159865	-47,191116	12,819504
203	2,25	-65,26045	-21,20606	-37,55783	-91,36453	-113,202236	-137,67643	-62,56077	-96,292235	-21,176575
203	3	-119,8193	-39,36859	-45,11036	-161,74702	-206,772904	-228,26211	-138,04139	-152,94773	-62,72701
204	0	-119,9701	-38,9865	44,63927	-167,95814	-206,34316	-138,25175	-227,65029	-63,27382	-15,67236
204	0,75	-65,88742	-22,5108	37,27047	-92,242389	-115,082184	-64,305234	-136,846174	-22,022208	-56,359148
204	1,5	-20,19851	-7,722209	29,84167	-28,277914	-36,5937464	-2,118751	-61,802091	11,663011	-48,020329
204	2,25	15,79164	4,253884	22,41287	22,108296	25,7561824	45,616722	0,790982	36,625346	-8,200394
204	3	43,38805	14,54248	14,98407	60,74327	75,333628	81,59221	51,62407	54,033315	24,065175
205	0	43,39214	14,54709	14,98414	60,748996	75,345912	81,601799	51,633518	54,037066	24,068786
205	0,75	55,0434	16,61411	7,429708	77,06076	92,634656	90,095898	75,236482	56,968768	42,103352
205	1,5	58,3009	16,96364	-0,1247246	81,62126	97,150904	86,8299954	87,0794446	52,3460854	52,5955346
205	-2,25	51,85965	14,56066	-7,679157	72,60351	85,528636	69,113083	84,471397	38,994528	54,352842

205	3	37,02465	10,44018	-15,23359	51,83451	61,133666	39,63617	70,10335	18,08555	-45,55775
206	0	37,021	10,43588	-15,23351	51,8294	61,122605	39,62757	70,09459	18,08539	-45,55241
206	0,75	8,819317	0,1809521	-22,80162	12,347043E	10,8727037E	-12,0374875	33,5657525	-14,8642347	30,7590053
206	1,5	-27,77611	-11,76147	-30,36972	-38,866554	-52,1496684	-75,462522	-14,7723082	-55,368219	6,371221
206	2,25	-74,07029	-26,5164	-37,93783	-103,698406	-131,310588	-153,338578	-77,462918	-104,601091	-23,725431
206	3	-128,7582	-42,95882	-45,50594	-180,26148	-223,243952	-242,9746	-151,96272	-161,38832	-70,37644
207	0	-130,679	-44,18373	44,32468	-182,9500	-227,508768	-156,67385	-245,32321	-73,28642	-151,93576
207	0,75	-70,59132	-23,88783	36,96864	-98,827848	-122,930112	-71,628774	-145,566054	-26,563548	-100,500826
207	1,5	-18,89743	-5,279431	29,61261	-26,456402	-31,1240056	1,656263	-57,568957	12,604923	-46,62029
207	2,25	23,0977	10,51647	22,25657	32,33678	44,543592	60,49028	15,97714	43,0445	-1,46864
207	3	56,69909	24,62487	14,90053	79,376726	107,4387	107,564308	77,763248	65,929711	36,128651
208	0	56,69687	24,62474	14,90032	79,375616	107,435828	107,561304	77,760664	65,927503	36,125863
208	0,75	68,92069	26,92047	7,544794	96,488966	125,77758	117,170092	102,080504	69,573415	54,493827
208	1,5	72,75076	27,52869	0,1892674	101,851064	131,346816	115,0188694	114,6403346	65,6649514	65,2554166
208	2,25	66,88207	25,32442	-7,166259	93,63489E	120,777556	98,416645	112,749163	53,027604	67,350122
208	3	52,61964	21,43264	-14,52178	73,66749E	97,435792	70,054428	99,097988	32,835896	61,679456
209	0	52,62238	21,43322	-14,52195	73,671332	97,440008	70,058126	99,102026	32,838192	61,682092
209	0,75	16,98008	5,727149	-21,87793	23,772112	29,5395344	4,225415	47,981075	-6,595758	37,159902
209	1,5	-27,05597	-11,66642	-29,23371	-37,878356	-51,133436	73,367294	-14,899874	-53,584083	4,583337
209	2,25	-80,79077	-31,8725	-36,58959	-113,10707E	-147,944924	-165,411014	-92,231834	-109,301283	-35,722103
209	3	-142,9193	-53,76607	-43,94547	-200,08702	-257,528872	-299,21532	-181,32376	-172,57284	-54,6819
210	0	-143,1898	-53,89036	46,41318	-200,46572	-258,052336	-179,30494	-272,1313	-82,45764	-175,284
210	0,75	-81,16973	-31,93108	38,55668	-113,637622	-148,750404	-90,778076	-167,891436	-34,496077	-111,5059437
210	1,5	-27,54342	-11,6593	30,70018	-38,560798	-51,706984	-14,011224	-75,411584	5,911102	-55,489258
210	2,25	16,38413	5,799976	22,84368	22,937782	28,9409176	48,304612	2,617252	37,569397	-8,057963
210	3	51,91794	21,57175	14,98718	72,685116	96,816328	98,860458	68,886098	61,713326	31,738966
211	0	51,91623	21,57199	14,98751	72,682722	96,81456	98,858976	68,883956	61,712117	31,737097
211	0,75	66,06934	25,5288	7,130817	92,497076	120,129288	111,942825	97,681191	66,593223	52,331589
211	1,5	71,82869	27,79813	-0,7258765	100,560166	130,671436	113,2666615	114,7184345	63,9199445	65,3716975
211	2,25	67,8893	27,25495	-8,58257	95,04502	125,07508	100,13954	117,30468	52,5178	69,66294
211	3	55,55615	25,02427	-16,43926	77,77861	106,706212	75,25239	108,13091	33,561275	65,439795
212	0	55,55774	25,02387	-16,43898	77,790836	106,70748	75,254178	108,132138	33,562985	65,440946
212	0,75	21,84547	10,97934	24,29554	30,583658	43,781508	12,898354	61,489444	-4,634617	43,956463
212	1,5	-20,26054	-4,752691	-32,1521	-28,364756	-31,9169536	-61,217439	3,086761	-50,366586	13,517614
212	2,25	-72,06529	-23,29722	-40,00866	-100,891406	-123,7539	-149,784228	-69,766908	-104,867421	-24,850101
212	3	-132,2638	-43,52926	-47,86522	-185,16932	-228,363376	-250,11104	-154,3806	-166,90264	-71,1722
213	0	-131,4314	-41,925	41,97072	-184,00396	-224,79768	-157,67196	-241,6134	-76,31754	-160,25898
213	0,75	-75,5401	-25,79432	35,94137	-135,75614	-131,919032	-80,50107	-152,38381	-32,04472	-103,92746
213	1,5	-28,04256	-11,35114	23,91201	-39,259584	-51,812896	-15,390202	-74,914222	4,673706	-55,150314
213	2,25	9,75624	0,2755457	23,88266	13,6587136	12,15474192	35,8686745	-11,8956455	32,6632616	-15,1020584
213	3	39,16126	10,22273	17,85331	54,625764	63,34982	75,069552	39,362932	53,094444	17,391824

214	0	39,16156	10,22431	17,85312	54,826154	53,352768	75,071302	39,365062	53,098524	17,392284
214	0,75	54,07893	13,21429	11,63231	73,710522	86,03758	89,741316	66,476696	60,303347	37,038727
214	1,5	60,60254	14,51678	5,411501	84,843556	95,949896	92,651329	81,828327	59,953787	49,130785
214	2,25	57,4274	13,00677	-0,8093072	80,39936	89,723712	81,1103428	82,7289572	50,8753528	52,4939672
214	3	45,85852	9,809257	-7,030116	64,201928	70,7250352	57,809365	71,869597	34,242552	48,302784
215	0	45,85674	9,806445	-7,030011	64,199436	70,7184	57,804522	71,864544	34,241055	48,301077
215	0,75	12,90848	0,4209138	-13,25003	18,071572	16,16219098	2,6601598	29,1602198	-1,632398	24,867662
215	1,5	-28,43352	-10,55392	-19,47006	-39,806928	-51,166496	-64,244204	-25,304084	-45,060228	-6,120108
215	2,25	-79,47427	-24,54035	-25,69008	-111,265979	-134,633684	-145,599554	-94,219394	-97,210923	-45,836763
215	3	-138,9088	-40,11428	-31,9101	-194,47232	-230,873408	-238,71494	-174,89474	-156,92802	-93,10782
216	0	-142,5509	-42,61236	64,28554	-199,57126	-239,240856	-149,3879	-277,95898	-64,01027	-192,58135
216	0,9	-67,23215	-18,772	46,34305	-94,12501	-110,71378	-53,10753	-145,79363	-14,165885	-106,851985
216	1,8	-4,584112	2,15236	28,40057	-6,3897558	-2,0331584	25,0759956	-31,7251444	24,2928692	-32,5082708
216	2,7	43,19812	18,21672	10,45808	60,477358	80,984496	80,512544	59,59384	49,336388	28,420228
216	3,6	78,30959	31,36508	-7,484406	109,633426	144,155336	117,852182	132,820994	62,994225	77,963037
217	0	78,30512	31,36324	-7,481799	109,62758	144,147328	117,847585	132,811183	62,992809	77,956407
217	0,9	93,11124	33,55862	-25,17408	130,355736	165,42728	120,118028	170,466188	58,626036	108,974196
217	1,8	95,26659	32,83799	-42,86636	133,373226	165,860692	104,291538	190,024258	42,873571	126,606291
217	2,7	82,51614	27,25737	-60,50863	115,522556	142,63116	65,718108	186,835368	13,705896	134,823156
217	3,6	57,11494	18,76075	-78,25091	79,960916	98,555125	9,047768	165,549588	-26,847464	129,654356
218	0	57,11515	18,75757	-78,24443	79,95121	98,550292	9,05132	165,54018	-26,840795	129,648055
218	0,45	38,55135	11,82167	-84,60629	53,97189	65,176292	-26,523	142,68958	-49,910075	119,302505
218	0,9	17,24767	4,521276	-90,36815	24,146738	27,5912456	-65,74967	116,18663	-75,445247	106,491053
218	1,35	-7,193825	-3,48665	-97,33	-10,071355	-14,21123	-109,44924	85,21076	-103,8044425	90,8555575
218	1,8	-34,62701	-12,07614	-103,6919	-48,477814	-60,874236	-157,320452	50,063348	-134,856209	72,527591
219	0	-12,49931	-7,516911	38,85944	-17,455034	-27,0262296	16,343357	-61,375523	27,610061	-50,108819
219	0,45	-0,3485726	2,144163	36,21743	-0,48800164	3,01237368	37,94330568	-34,49155412	35,90371466	-36,53114534
219	0,9	10,88208	11,22367	33,57541	15,233912	31,016368	57,857576	-9,293244	43,369282	-23,781538
219	1,35	21,05661	19,59566	30,9334	29,475254	56,620988	75,796992	13,930192	49,884349	-11,982451
219	1,8	30,54546	27,60314	28,29138	42,765544	80,819575	92,549072	35,966312	55,782294	-0,800466
220	0	30,54823	27,60657	28,29339	42,767522	80,828544	92,547936	35,971156	55,786757	-0,799983
220	0,9	41,01131	35,79254	22,18115	57,415934	96,481635	107,187262	62,824562	59,091329	14,729029
220	1,8	47,15992	41,06241	16,0639	66,019588	122,28816	113,719614	81,581814	58,510128	26,372328
220	2,7	46,88552	41,47228	9,95666	65,639728	122,616272	107,691564	87,778244	52,153628	32,240308
220	3,6	42,29665	38,96616	3,844416	59,21531	113,101836	93,565556	85,877724	41,911401	34,222569
221	0	42,29866	38,96811	3,846384	59,218124	113,107368	93,572886	85,880118	41,915178	34,22241
221	0,9	25,8489	24,74403	-2,933277	36,18846	70,609122	52,829433	58,695987	20,330733	26,197287
221	1,8	5,081553	7,603953	-9,712937	7,1143142	18,2643084	3,9489996	23,4148736	-5,139493	14,2864247
221	2,7	-22,10259	-14,39613	-16,4926	-30,943626	-49,556916	-57,411836	-24,426633	36,394931	-3,399731
221	3,6	-53,50431	-39,31221	-23,27226	-75,046034	-127,224708	-126,909642	-30,365122	-71,516139	-24,971619
222	0	-52,00717	-36,94408	10,0616	-72,810038	-121,519132	-85,291084	-109,414284	-36,744853	-56,668053

222	0,75	-31,05905	8,104067	-43,48267	-77,89878	-54,552993	-70,761127	-19,849078	-36,057212
222	1,5	-12,74468	6,146532	-17,842552	-40,118928	-24,662904	-55,955968	-5,32368	-17,616744
222	2,25	1,720937	4,188997	2,4093118	-11,4675892	-2,2038246	-10,5818186	5,7378403	-2,6401537
222	3	13,55281	2,231462	18,973934	11,3232616	15,407265	10,944341	14,428991	9,966067
223	0	13,55828	3,083004	18,981592	11,3371296	15,418206	10,955658	14,433726	9,971178
223	0,75	18,41094	2,360418	25,775316	25,8697968	24,44023431	24,46685769	16,55653431	16,58315769
223	1,5	20,62985	6,116341	28,88179	34,5419656	28,614263	33,130059	16,308967	20,824763
223	2,25	19,00001	7,059763	26,600014	34,0956328	25,357292	34,362258	12,597526	21,602492
223	3	14,73643	6,315686	20,631002	27,7888136	17,252333	30,746471	6,515718	20,009856
224	0	14,73104	6,311229	20,623456	27,7752144	17,24118	30,735774	6,510639	20,005233
224	0,75	4,254016	1,159952	5,956224	6,9607424	-2,7863978	15,3159402	-5,2225546	12,8797834
224	1,5	-8,856758	-5,678824	-12,3994612	-19,714228	-27,6619736	-4,9518936	-19,3261222	3,3639576
224	2,25	-25,81628	-15,330	-36,142792	-55,507696	-59,968546	-32,650726	-36,893562	-9,575742
224	3	-45,40956	-26,66888	-63,573384	-97,16168	-97,123142	-65,197562	-56,831394	-24,905814
225	0	-45,60497	15,25276	-63,846358	-98,679884	-66,944404	-87,443924	-25,791713	-55,257233
225	0,75	-25,21463	12,57622	-35,300482	-52,098484	-31,331916	-56,484356	-10,116947	-35,269387
225	1,5	-7,458044	9,899688	-10,4412616	-11,3775872	-0,5674238	-20,3667998	3,1874484	-16,6119276
225	2,25	6,449794	7,803163	9,0297116	20,2248136	22,7660678	8,3197638	13,0279666	-1,4183374
225	3	17,72388	4,546617	24,813432	45,966704	41,251553	32,158319	20,498109	11,404875
226	0	17,72771	15,43964	24,818794	45,976676	41,259215	32,166569	20,501262	11,408616
226	0,75	22,1369	2,145168	30,99166	55,291144	46,663730	42,373402	22,068378	17,778042
226	1,5	23,91235	18,78143	33,47729	58,745108	47,2202634	47,3722366	21,2651284	21,7771016
226	2,25	21,83905	16,79608	30,57467	53,080588	40,345799	45,660081	16,998004	22,312286
226	3	17,13199	13,12323	23,984786	41,555556	28,623322	38,739974	10,360495	20,477087
227	0	17,12761	13,11955	23,978654	41,544412	28,614168	38,731196	10,356335	20,473363
227	0,75	5,590726	4,342913	7,8270164	13,657532	4,0067442	18,0968242	-2,0133866	12,0766934
227	1,5	-8,579902	-6,121222	-12,0118628	-20,0896376	-25,4486714	-7,3855374	-16,7534788	1,3096552
227	2,25	-26,59928	-19,39786	-37,238992	-62,955712	-62,335065	-0,298906	-34,957442	-12,921262
227	3	-47,25241	-34,36199	-66,153374	-111,682076	-104,065502	-78,060262	-55,531789	-29,522549
228	0	-47,12153	18,22853	-65,970142	-111,168188	-72,456276	-108,913336	-24,180847	-60,637907
228	0,75	-26,37257	15,01394	-36,921598	-62,848412	-36,133974	-68,151854	-8,721375	-38,749253
228	1,5	-8,257367	11,79934	-11,5603138	-20,3891345	-4,6596844	-28,2583544	4,3677097	-19,2309703
228	2,25	6,00909	8,584748	8,412726	12,9516408	19,383614	2,214118	13,992929	-3,176567
228	3	17,6418	12,0486	24,69852	40,43192	39,578913	27,638607	21,247773	10,507467
229	0	17,64622	12,04333	24,704708	40,443192	38,588294	27,847294	21,252098	10,511098
229	0,75	22,37976	15,35643	2,594163	51,426	44,806305	56,617979	22,735947	17,547621
229	1,5	24,47955	16,98303	-0,1821725	56,548308	46,1763175	48,5406625	21,8494225	22,2137675
229	2,25	22,73059	15,79713	-2,958508	52,552116	40,11533	46,032346	17,499023	23,416039
229	3	18,34787	12,92373	-5,734645	42,695412	29,206329	40,676019	10,778238	22,247928
230	0	18,34412	12,92043	-5,734453	42,685632	29,198921	40,667827	10,775255	22,244161
230	0,75	6,91244	4,853319	-8,253929	16,1308032	4,9648828	21,4727408	-1,9798094	14,5280486

230	1,5	-7,035379	-4,901286	-10,7734	-9,8495306	-16,284515	-24,1171428	-2,5703428	-17,1052411	4,4415589
230	2,25	-24,89075	-17,4624	-13,29288	-34,84705	-57,81624	-60,63018	-34,04442	-35,694555	-9,108195
230	3	-45,37988	-31,723	-15,81236	-63,531832	-105,212655	-101,991216	-70,366496	-56,654292	-25,029532
231	0	-44,61178	-31,16885	15,32549	-62,456492	-103,404233	-69,377496	-100,028476	-24,852112	-55,476092
231	0,75	-25,27347	-17,72229	12,69711	-35,382858	-58,683825	-35,353344	-60,747564	-10,049013	-35,443233
231	1,5	-8,568908	-5,963231	10,06873	-11,9964712	-19,8238552	-6,1771906	-25,3146506	2,3567128	-17,7807472
231	2,25	4,266903	2,983329	7,40349	6,0016642	9,91761	15,5679616	0,6872636	11,2985617	-3,5821363
231	3	14,50896	10,24239	4,811969	20,312544	33,799575	32,465111	22,841173	17,670033	8,245095
232	0	14,5143	10,24684	4,81195	20,32002	33,812104	32,47595	22,85205	17,87482	8,25092
232	0,75	19,25099	13,49714	2,257739	26,951386	44,696612	38,856067	34,340589	19,58363	15,068152
232	1,5	21,35393	15,05993	-0,2964725	29,895502	49,720604	40,3881735	40,981185	18,9220645	19,5150095
232	2,25	19,60812	13,81022	-2,850684	27,451368	45,626112	34,4829	40,190658	14,796624	20,497992
232	3	15,22856	10,87302	-5,404895	21,319984	35,671104	23,742397	34,552187	8,300809	19,110599
233	0	15,22377	10,86895	-5,404858	21,313278	35,658844	23,732616	34,542352	8,296535	19,106251
233	0,75	4,703586	3,409616	-7,86156	6,5850204	11,099652	1,1923612	16,9154812	-3,6283326	12,0947674
233	1,5	-8,450346	-5,73215	-10,31826	-11,8304844	-19,3199592	-26,1958902	-5,5993702	-17,9235714	2,7179486
233	2,25	-25,45303	-17,69655	-12,77496	-35,634242	-58,858115	-61,015146	-35,465226	-35,682687	-10,132767
233	3	-45,08946	-31,34338	-15,23167	-63,125244	-104,256575	-100,682402	-70,219062	-55,812184	-25,348844
234	0	-45,16309	-31,43999	15,66228	-63,228326	-104,499652	-69,968418	-101,302978	-24,979501	-56,314061
234	0,75	-24,90284	-17,31066	12,48521	-34,963976	-57,580944	-34,209156	-60,179578	-9,427346	-35,397766
234	1,5	-7,276348	-4,869431	10,30314	-10,186972	-16,5227072	-3,2979095	-23,9041866	3,7544268	-16,8518532
234	2,25	6,501399	4,759597	7,621065	9,1019586	15,417032	20,1823408	4,9402108	13,4723241	-1,7698059
234	3	17,6454	12,70113	4,938994	24,70356	41,496265	38,814604	28,936616	20,819857	10,941866
235	0	17,64921	12,70442	4,938964	24,708894	41,506156	38,822456	28,944528	20,823253	10,945325
235	0,75	21,50962	15,24505	2,348593	30,113463	50,203624	43,405187	38,708001	21,707251	17,010065
235	1,5	22,73628	16,09816	-0,2417778	31,830792	53,040952	43,1399182	43,6234738	20,2208742	20,7044298
235	2,25	20,11419	14,13877	-2,832149	28,159866	46,75906	35,443649	41,107947	15,270622	20,93492
235	3	14,85836	10,49188	-5,42252	20,801704	34,61704	22,899392	33,744432	7,950004	18,795044
236	0	14,8544	10,48851	-5,422452	20,79616	34,606856	22,891338	33,736242	7,946508	18,791412
236	0,75	2,299549	1,423018	-7,896818	3,2195086	5,0364076	-3,7142212	12,0794148	-5,8271339	9,9665021
236	1,5	-12,88885	-5,329979	-10,37118	-18,04439	-30,3945864	-35,16779	-14,425419	-21,971145	-1,226765
236	2,25	-31,92611	-22,99548	-12,84555	-44,696554	-74,9441	-74,052362	-48,361262	-41,579049	-15,887949
236	3	-53,59711	-39,14847	-15,31991	-75,035954	-125,254064	-117,784912	-87,145092	-63,557309	-32,97489
237	0	-54,87272	-38,66572	15,32898	-76,821808	-127,744416	-89,204004	-119,861964	-34,066468	-64,714428
237	0,83	-29,32715	-20,80337	12,74276	-41,05801	-68,477972	-43,25319	-68,73871	-13,651675	-39,137195
237	1,67	-7,033058	-5,004309	10,15655	-9,8462812	-16,446564	-3,2874286	-23,605296	3,8267978	-16,4863022
237	2,50	10,50959	7,322598	7,57033	14,713426	24,3276648	27,504436	12,363776	17,028961	1,888301
237	3,33	24,80075	17,56621	4,984114	34,72105	57,86636	52,311224	42,342996	27,304789	17,336561
238	0	24,80621	17,56708	4,984088	34,72694	57,86636	52,32242	42,354244	27,309677	17,341501
238	0,83	30,43223	21,38625	2,461109	42,605122	70,736676	60,366035	55,443817	29,850116	24,927898
238	1,67	32,80677	23,11634	-6,19E-02	45,929478	76,357468	62,42459408	62,54833392	29,46422308	20,58796292

238	2.50	30,42986	21,37827	-2,584849	42,601504	70,721064	55,309253	60,476551	24,534225	28,971223
238	3.33	24,80148	17,55491	-5,107828	34,722072	57,849632	42,298858	52,424514	17,216504	27,42618
239	0	24,79503	17,55025	-5,107782	34,714442	57,835636	42,197704	52,413268	17,205545	27,424209
239	0.83	10,50213	7,298705	-7,519648	14,702982	24,280484	12,381613	27,420909	1,932269	16,971566
239	1.67	-7,043433	-5,036252	-9,931515	-9,8608062	-16,5101228	-23,4158866	-3,5566566	-16,2795547	3,5924253
239	2.50	-29,34073	-20,84357	-12,34338	-41,077022	-68,558588	-68,359826	-43,709066	-33,750037	-14,063277
239	3.33	-54,86971	-38,7343	-14,75525	-76,845594	-127,842532	-119,357202	-89,846702	-64,155989	-34,645489
240	0	-53,58142	-38,10047	15,80157	-75,013988	-125,258456	-86,595634	-118,199744	-32,421709	-64,024842
240	0.75	-31,91266	-22,85483	13,14061	-44,677724	-74,86292	-48,009412	-74,290632	-15,580784	-41,862004
240	1.5	-12,87766	-9,296696	10,47966	-18,028724	-30,3279056	-14,270228	-35,229548	-1,110234	-22,069554
240	2.25	2,308597	1,448941	7,818702	3,2320358	5,088622	12,0379594	-3,5994446	9,6964393	-5,7405647
240	3	14,8611	10,50708	5,157746	20,80554	34,644648	33,498146	23,182654	18,532736	8,217244
241	0	-53,58142	-38,10047	15,80157	-75,013988	-125,258455	-86,596634	-118,199744	32,421708	-64,024648
241	0.75	-31,91266	-22,85483	13,14061	-44,677724	-74,86292	-48,009412	-74,290632	-15,580784	-41,862004
241	1.5	-12,87766	-9,296696	10,47966	-18,028724	-30,3279056	-14,270228	-35,229548	-1,110234	-22,069554
241	2.25	2,308597	1,448941	7,818702	3,2320358	5,088622	12,0379594	-3,5994446	9,6964393	-5,7405647
241	3	14,8611	10,50708	5,157746	20,80554	34,644648	33,498146	23,182654	18,532736	8,217244
242	0	14,86505	10,51044	5,157663	20,81107	34,654764	33,506183	23,190817	18,536228	8,220652
242	0.75	20,11863	14,14971	2,576939	28,166052	46,781892	40,869005	35,715127	20,653736	15,529828
242	1.5	22,73846	16,10148	-3,80E-03	31,833844	53,04832	43,3838277	43,3914353	20,461597	25,4684183
242	2.25	21,50954	15,24074	-2,584548	30,113356	50,196632	38,46764	43,636736	16,774536	21,943134
242	3	17,64687	12,69251	-5,165291	24,705516	41,48426	28,703463	39,034045	12,774332	21,047474
243	0	17,64306	12,68919	-5,165255	24,700284	41,474376	28,695607	39,026117	12,773459	21,044009
243	0.75	6,49688	4,740292	-7,610726	9,095632	15,3807232	4,925822	20,147274	-1,793534	13,457918
243	1.5	-7,283051	-4,89611	-10,0562	-10,1962714	-16,5734372	-23,6919712	-3,5795712	-16,6109459	3,5014541
243	2.25	-24,91173	-17,34501	-12,50167	-34,876422	-57,646092	-59,740756	-34,737416	-34,322227	-9,918867
243	3	-45,17416	-31,48141	-14,94714	-63,243824	-104,579248	-100,637542	-70,743262	-55,603584	-25,709604
244	0	-45,06669	-31,28635	15,65463	-63,093366	-104,138188	-69,711748	-101,021008	-24,905391	-56,214651
244	0.75	-25,43557	-17,65136	12,38227	-35,609798	-58,76446	-35,191574	-61,156114	-9,909543	-35,874083
244	1.5	-8,438195	-5,703865	10,20951	-11,813473	-19,252018	-5,520189	-26,139209	2,7151345	-17,9038855
244	2.25	4,710425	3,43113	7,63695	5,594595	11,142218	16,72059	1,44669	11,6763325	-3,3575675
244	3	15,2253	10,87952	4,96439	21,31542	35,676152	34,11337	24,18459	18,66716	8,73835
245	0	15,23009	10,88269	4,954375	21,322125	35,689412	34,12372	24,19423	18,671456	8,742706
245	0.75	19,60405	13,80782	2,358214	27,44567	45,617372	39,690894	34,974466	20,00159	15,285431
245	1.5	21,34427	15,04544	-0,2479474	29,681973	49,689828	40,4105166	40,9065114	18,9618955	19,4577904
245	2.25	19,23574	13,47057	-2,854109	26,930036	44,6358	33,699349	39,407567	14,458057	20,166275
245	3	14,49346	10,2082	-5,46027	20,290844	33,725272	22,140082	33,060622	7,583844	18,504384
246	0	14,48812	10,20374	-5,460227	20,283368	33,711728	22,129257	33,049711	7,579081	18,499535
246	0.75	4,260081	2,932773	-7,976131	5,9641134	9,804534	0,0687392	16,0210012	-4,1420581	11,8102039
246	1.5	-8,601709	-6,025635	-10,49203	-12,0423926	-19,9631628	-26,8397758	-5,8557158	-18,2335681	2,7504919
246	2.25	-25,31225	-17,79666	-13,00794	-35,43715	-58,849356	-61,1793	-35,16342	-35,788955	-9,773085

246	3	-44,55654	-31,25513	-15,52354	-62,51555	-103,556056	-100,366816	-69,319138	-55,714726	-24,667046
247	0	45,39273	-31,71409	14,92332	-53,54522	-105,21382	-71,232046	-101,108685	-25,930137	-55,776777
247	0,75	-24,89455	-17,44899	12,32974	-34,85237	-57,791844	-34,99271	-59,65219	-10,075355	-34,734835
247	1,5	-7,030122	-4,871395	9,736164	-9,8421738	-16,2303784	-3,5713774	-23,0437054	3,4090542	-16,0632738
247	2,25	6,985555	4,893701	7,142557	9,779777	16,2125876	30,418954	6,13378	13,4295865	-0,8555875
247	3	18,36748	12,9713	4,549009	25,714472	42,795056	29,561285	30,463267	21,079741	11,981723
248	0	18,37123	12,9746	4,548648	25,719722	42,804836	39,568724	30,471428	21,082755	11,985459
248	0,75	22,76459	15,85832	2,13355	31,870426	52,69082	45,309378	41,042278	22,621681	18,354581
248	1,5	24,5242	17,05454	-0,2815475	34,33358	56,716304	46,2020321	46,7651279	21,7902321	22,3533279
248	2,25	22,43505	15,43826	-2,696646	31,40537	51,623276	39,663674	45,056966	17,494899	22,886191
248	3	17,71216	12,13449	-5,111743	24,797024	40,669776	28,277339	38,500825	10,829201	21,052687
249	0	17,70774	12,13075	-5,112061	24,790536	40,658488	28,267977	38,492099	10,824905	21,049027
249	0,75	6,088998	3,691854	-7,157342	8,5245972	13,213764	3,8413096	18,1559936	-1,6772438	12,6374402
249	1,5	-8,163493	-6,434545	-9,202624	-11,428632	-20,0914636	-25,4333606	-7,0281126	-16,5497677	1,8554803
249	2,25	-26,26473	-19,37345	-11,2473	-35,770522	-62,575196	-62,139025	-39,643216	-34,886157	-12,390347
249	3	-46,59973	-33,99984	-13,29319	-65,795022	-110,79942	-103,692706	-77,106326	-55,592947	-29,006567
250	0	-47,08311	-34,10058	17,17854	-65,916334	-111,06066	-73,421772	-107,778852	-25,196259	-59,553339
250	0,75	-26,49335	-19,24506	14,12075	-37,05559	-62,584116	-36,9163	-65,15786	-9,723235	-37,964795
250	1,5	-8,537333	-6,077043	11,06301	-11,9522552	-19,9680684	5,2588326	-27,3848526	3,3794103	1,7466097
250	2,25	5,569933	4,278476	8,00521	7,7975022	13,5294812	18,9676456	2,9571456	13,0181897	-2,9923103
250	3	17,04345	12,94649	4,947455	23,85593	41,156524	38,346116	28,451144	20,286591	10,391619
251	0	17,04787	12,95019	4,947855	23,867718	41,177748	38,355489	28,459779	20,290938	10,395228
251	0,75	21,68021	16,51347	2,303518	30,352294	52,437804	44,83324	40,226204	21,815707	17,208671
251	1,5	23,6788	18,38925	-0,3408161	33,15332	57,83736	46,4629919	47,1448281	20,9701019	21,6517381
251	2,25	21,82864	17,45253	-2,985155	30,560596	54,118416	40,661743	46,632053	16,660621	22,630931
251	3	17,34473	14,82831	-5,629451	24,282522	44,538972	30,012495	41,271477	9,980766	21,239748
252	0	17,34089	14,82495	-5,629113	24,277246	44,528988	30,004905	41,263131	9,977688	21,235914
252	0,75	5,974471	7,07932	-8,026261	6,3642554	18,4962772	6,2227242	22,2749462	-2,6492371	13,4032849
252	1,5	-8,025696	-2,353812	-10,42341	-11,2359744	-13,3969344	-22,4080572	-1,5612372	-17,6465364	3,2002836
252	2,25	-25,87461	-14,59945	-12,87056	-36,224454	-54,408652	-58,469542	-32,828422	-36,107709	-10,466589
252	3	-46,35728	-28,53258	-15,21771	-64,900152	-101,280864	-99,379025	-68,943606	-56,939262	-26,503842
253	0	-46,19188	-27,75401	15,12455	-64,665532	-99,836672	-58,05906	-98,308926	-26,448032	-56,697352
253	0,75	-26,27453	-15,85493	12,89394	-36,764342	-56,99742	-34,500486	-60,268366	-10,763137	-35,531017
253	1,5	-8,990943	-5,643476	10,64322	-12,5873202	-19,8186932	-5,7893876	-27,0758276	2,5513713	-18,7350687
253	2,25	4,4439	1,755539	8,402498	6,22146	8,1415424	15,490717	-1,314279	12,402008	-4,402988
253	3	15,24499	7,467055	6,161778	21,342586	30,242176	31,922821	19,599265	19,882269	7,558713
254	0	15,25015	7,471457	6,161471	21,350252	30,2545472	31,933144	19,610202	19,886633	7,563691
254	0,75	19,91639	8,78019	3,926758	27,882546	37,947972	35,606616	28,7531	21,851509	13,997993
254	1,5	21,94885	8,401423	1,692045	30,72839	39,7808968	36,432083	33,047997	21,46011	18,061919
254	2,25	20,13255	5,210156	-0,5426666	28,16557	32,4953096	28,8265492	29,9118828	17,5766282	18,6619618
254	3	15,68251	0,3313887	-2,77379	21,955514	19,34923392	16,3730217	21,9277797	11,33688	16,891658

MOMEN BALOK PORTAL AS 2 (ANALISIS 3D)

LABEL	STATION	MD (KN.m)	ML (KN.m)	ME (KN.m)	1.MD (KN.m)	1.2MD+1.6ML (KN.m)	1.2MD+ML+ME (KN.m)	1.2MD+ML - ME (KN.m)	C.SMD+ME (KN.m)	C.SMD+ME (KN.m)
258	0	-19.38443	-16.98771	187.86559	-27.138202	-50.441852	147.618874	-228.114926	170.419913	-235.311887
258	0.9	24.95673	19.58704	150.752	34.939422	61.28734	200.329116	-101.259884	173.255057	-128.332943
258	1.8	62.54374	51.34637	113.722	87.561236	157.20668	240.120858	12.676858	170.011365	-57.432634
253	2.7	89.09775	74.60168	76.65005	124.75685	226.279988	258.15903	154.85893	156.838025	3.537925
258	3.6	107.7884	92.0854	39.5781	150.90376	276.68272	261.00958	161.85338	136.58755	57.43146
259	0	107.7859	92.08498	39.57739	150.90026	276.679048	261.00645	181.85067	136.5827	57.42992
259	0.9	56.11002	53.59797	2.768211	78.554028	153.088776	123.655205	118.161783	53.26722	47.730807
259	1.8	-3.499157	9.278972	-34.0409	-4.8988198	10.6473668	-28.9509864	39.1209536	-37.1902113	30.8917287
259	2.7	-75.55173	-44.76003	-70.85015	-105.772422	-162.278124	-206.272256	-64.571956	-138.84670	2.853593
259	3.6	-155.5376	-104.631	-107.6553	-217.75264	-354.05472	-398.53542	-183.61682	-247.64514	-52.32454
260	0	-158.6447	-103.8802	64.555	-222.10258	-356.58196	229.69784	-359.80994	-78.22423	-207.33623
260	0.75	-89.1702	-62.25264	51.61018	-124.83828	-206.608464	-117.6467	-220.86706	-28.643	-131.66336
260	1.5	-24.42195	-24.00004	36.66455	-34.19073	-67.706404	-14.64202	-91.97074	16.684503	-50.544115
260	2.25	32.99005	3.27548	25.71854	46.18507	53.3921366	73.934148	22.497028	55.409555	3.972505
260	3	85.6758	37.88014	12.77272	119.94512	163.479184	153.45382	127.91838	89.86092	64.3355
261	0	85.67776	37.88121	12.77356	119.94554	163.423248	153.457602	127.921442	89.863054	64.336904
261	0.75	92.60313	47.12494	1.734952	129.644382	186.52366	159.963658	156.513734	65.07779	31.607855
261	1.5	94.80225	52.99367	-9.303157	132.72315	198.552972	157.453213	176.09527	76.018658	54.62182
261	2.25	89.66512	53.2374	-20.34127	125.53168	192.777984	140.454274	181.176814	60.357338	101.039878
261	3	79.80173	50.10612	-31.37939	111.722422	175.931868	114.488806	177.247586	40.442167	103.200947
262	0	79.80117	50.10626	-31.37791	111.721638	175.93142	114.485754	177.245574	40.443143	103.198963
262	0.75	13.77109	5.260581	42.92059	19.279526	24.9422376	-21.134701	64.706479	-30.526609	55.314571
262	1.5	-56.98525	-42.9601	-54.46327	-79.77525	-137.17846	-165.80567	-56.87913	-105.749955	3.176845
262	2.25	-135.0778	-96.80578	-65.00595	-163.10852	-316.982608	-324.90509	-192.89319	-187.57597	-55.56407
262	3	-217.8967	-154.0265	-77.54863	-305.05536	-507.91844	-433.05117	-337.95391	-273.65555	-118.5561
263	0	-219.7326	-157.7664	87.50104	-307.62564	-516.10536	-333.94448	-508.94656	-110.2553	-285.26038
263	0.75	-126.7516	-87.64004	73.28938	-177.45224	-292.325184	-156.45258	-313.03134	-40.78706	-157.36582
263	1.5	-38.49586	-20.8887	59.07772	-53.855604	-79.61852	-8.007212	-126.162652	24.430546	-93.724894
263	2.25	42.42163	40.23764	44.86606	53.390262	115.28618	136.009656	46.277536	83.045527	-6.886593
263	3	118.6139	97.98988	30.6544	166.05946	299.119048	270.98006	209.67126	137.40691	76.09811
264	0	118.6072	97.982	30.65499	166.05008	299.09984	270.96563	209.65565	137.40147	76.09149
264	0.75	124.5949	101.1483	16.38003	74.43286	311.35116	267.04221	234.28215	128.51544	95.75538
264	1.5	125.8564	100.9396	2.105068	176.19895	312.53104	254.072348	249.862212	115.375828	111.165892
264	2.25	119.7817	95.10583	-12.16989	167.69438	295.907368	220.67398	251.01376	95.03354	119.97342
264	3	103.9807	85.89711	-26.44485	152.57298	268.212216	190.2291	243.1188	71.63778	124.52748

265	0	105.9532	85.90565	-26.4473	152.58488	268.23608	190.24796	243.13742	71.64595	24.53501
265	0.75	27.4565	21.63524	-40.93584	38.43091	67.557164	13.63708	99.57436	-16.23355	55.644525
265	1.5	-58.57415	-46.01015	-55.4337	-62.33981	-144.19322	-172.02027	-61.15339	-106.365875	2.500405
265	2.25	-152.4152	-119.2806	-69.92735	-213.38128	-373.7472	-372.10619	-232.25749	-207.10103	-67.24633
265	3	-250.7425	-195.9259	-84.42155	-351.0395	-614.37244	-581.23845	-412.39535	-310.0695	-141.2467
266	0	-250.2521	-195.1337	80.23809	-350.35294	-612.51644	-415.19813	-575.67431	-144.9886	-305.46498
266	0.75	-152.2491	-119.484	56.7811	-213.14874	-373.87332	-235.40182	-368.96402	-70.24309	-203.80529
266	1.5	-58.9727	-47.20931	53.32411	-82.561178	-146.30162	-64.651924	-171.300144	0.249067	-106.399153
266	2.25	26.96828	19.44041	39.86712	37.75552	63.463592	91.669466	11.935226	64.138572	-15.595638
266	3	108.1826	82.71513	26.41012	151.45584	262.163328	238.94437	186.12413	123.77446	70.95422
267	0	108.1743	82.70707	26.41017	151.44402	262.140472	238.9264	186.10506	123.76704	70.9467
267	0.75	116.5655	90.70452	12.99821	165.9917	287.405832	245.98133	219.95491	119.70716	53.71074
267	1.5	124.2305	95.32697	-0.4137441	173.9227	301.599752	243.9898259	244.8173141	111.3937059	112.2211941
267	2.25	22.5592	94.32442	-13.8257	171.58258	297.990112	227.56976	255.22116	96.47756	124.12898
267	3	116.1517	89.94688	-27.23765	162.62638	283.309048	202.10326	256.57658	77.30787	131.78319
268	0	115.1683	89.95359	-27.23755	162.63562	283.327704	202.118	256.5531	77.31392	131.78902
268	0.75	39.44753	30.703	-40.67678	55.226542	96.461836	37.361256	118.718816	-5.176003	76.181557
268	1.5	-41.59554	-31.9226	-54.1200	-58.799356	-101.475608	-136.442058	-28.202038	91.919596	16.320424
268	2.25	-130.7829	-100.1732	-67.56124	-183.09606	-317.2166	-324.67302	-189.55144	-185.26585	-50.14337
268	3	-224.2524	-171.7988	-81.00247	-314.00936	-544.02898	-521.95215	-355.94721	-252.86563	-120.86069
269	0	-224.5866	-171.9204	81.90012	-314.42124	-544.57656	-359.5242	-523.32444	-120.22782	-284.02806
269	0.75	-137.8493	-105.7364	68.25931	-192.98902	-334.5974	-202.85625	-339.41487	-55.80506	-192.32368
269	1.5	-55.8382	-42.92744	54.6185	-78.17348	-135.689744	-55.31478	-164.55178	4.36412	-104.87288
269	2.25	18.83662	14.25654	40.97769	26.371268	45.414408	77.838174	-4.117206	57.930648	-24.024732
269	3	88.7852	68.06551	27.33688	124.29928	215.447056	201.94463	147.27087	107.24356	52.5698
270	0	88.7846	68.06364	27.33709	124.29844	215.443344	201.94225	147.26807	107.24323	52.56905
270	0.75	97.57265	74.47913	13.8341	136.60171	236.253788	205.40041	177.73221	101.649485	73.981285
270	1.5	101.6345	77.51962	0.311117	142.2883	245.992792	193.9121317	199.149083	91.3021617	91.1399383
270	2.25	96.36002	74.93511	-13.17188	137.704028	237.9282	179.795254	206.139014	75.352138	101.695898
270	3	90.35333	68.9756	-26.67455	126.503062	218.792156	150.731335	204.081655	54.648537	107.998257
271	0	90.35954	68.9772	-26.67468	126.503356	218.794968	150.733968	204.083328	54.648906	107.998266
271	0.75	21.33294	15.7275	-40.12114	25.866116	50.763526	1.205688	81.448168	-20.921494	59.320784
271	1.5	-52.4199	-40.89721	-53.5676	-73.36785	-128.339416	-157.36969	-50.23345	-100.74551	6.38969
271	2.25	-133.509	-103.1469	-67.01406	-186.9126	-325.24584	-330.37176	-196.34364	-187.17216	-53.14404
271	3	-219.3243	-168.7716	-80.45053	-307.05402	-533.22372	-512.42129	-351.50023	-277.8524	-116.93134
272	0	-220.041	-169.4098	81.40836	-308.0574	-535.10488	-352.05064	-514.86736	-116.62854	-279.44526
272	0.75	-128.2325	-98.73017	67.64059	-179.5255	-311.84727	-184.96858	-320.24976	-47.76866	-183.04984
272	1.5	-41.15032	-31.42551	53.87282	-57.610448	-99.6612	-26.933074	-134.67814	16.837532	90.908108
272	2.25	38.59565	30.25416	40.10505	54.03391	94.721436	116.67399	36.46389	74.841135	-5.368965

272	113.6154	88.55882	26.33727	159.03150	278.032592	251.23457	198.55203	128.59113	75.91659
273	0	88.55186	26.33751	159.05162	278.012935	251.21933	198.54431	128.58498	75.90998
273	0.75	118.6531	12.70199	166.11434	289.914456	247.29242	221.85544	119.48978	94.0858
273	1.5	118.9717	-0.9335303	166.56038	290.744536	234.3190697	236.1861303	106.1409997	106.0080603
273	2.25	111.954	-14.56905	156.7356	273.771072	206.91717	236.05527	86.19955	115.32765
273	3	100.2101	-28.20457	140.29414	245.726152	170.46882	226.87796	61.98452	118.39366
274	0	100.2182	-28.20436	140.30548	245.74848	170.48663	226.89535	61.99202	118.40074
274	0.75	18.14888	-41.83371	25.408432	45.3732	-5.308464	78.358956	-25.499718	58.167702
274	1.5	-68.64669	-55.46306	-96.105366	-166.07358	-190.150058	-79.223938	-117.245081	-6.318961
274	2.25	-162.7785	-69.09241	-227.8899	-395.3238	-389.42011	-251.23529	-215.59306	-77.40824
274	3	-261.6366	-82.72176	-366.29124	-635.64568	-597.73678	-432.29326	-318.1947	-152.75118
275	0	-265.4279	77.42843	-371.59906	-624.45932	-444.73515	589.55261	-161.45668	-316.31554
275	0.83	-155.9507	54.47554	-218.33098	-379.3098	-242.7709	-371.72198	-75.88009	-204.63117
275	1.67	-52.30819	51.52265	73.231466	-127.93418	-51.974898	-155.020198	4.445279	-58.600021
275	2.50	42.27736	38.56976	59.188304	101.46224	121.08472	43.86552	76.619364	-0.520136
275	3.33	131.0282	25.61688	183.43948	317.19048	282.82362	231.56986	143.54226	92.3085
276	0	131.0208	25.61712	183.42912	317.1686	282.80698	231.57274	143.53584	92.3016
276	0.83	141.3859	12.8118	197.94026	341.8256	290.07658	264.45298	140.05911	114.43551
276	1.67	145.9163	6.47E-03	204.28282	352.8146	286.1779319	286.164988	131.3311419	131.3181961
276	2.50	141.3897	-12.79885	197.94558	341.82396	264.46649	290.05419	114.45188	140.04958
276	3.33	131.0284	-25.60418	183.43976	317.165328	231.58693	282.79529	92.32138	143.52974
277	0	131.0358	-25.60396	183.45012	317.187008	231.60403	282.81195	92.32826	143.53618
277	0.83	42.28601	-38.42079	59.200414	101.450252	44.014322	120.855902	-0.363381	76.478195
277	1.67	-52.29687	-51.23762	-73.218418	-127.95554	-154.744324	-52.269084	-98.306603	4.168637
277	2.50	-155.9412	-64.05445	-218.31768	-379.34192	-371.31669	-243.20779	-204.40153	-76.29263
277	3.33	-265.4187	-76.87128	-371.58618	-624.39752	-599.05902	-445.31546	-315.74811	-162.00555
278	0	-261.6451	82.27546	-366.30314	-535.5962	-432.71246	-597.26338	-153.20513	-317.75605
278	0.75	-162.7855	68.67454	-227.89284	-395.2824	-251.63048	-388.97956	-77.8325	-215.18158
278	1.5	-68.55237	55.07362	-96.113318	-166.040284	-79.595124	-189.742364	-6.713513	-116.860753
278	2.25	18.14462	-41.47271	25.402482	45.596456	78.011816	-4.333504	57.802877	-25.142543
278	3	100.2154	27.87179	140.30156	245.765664	226.57226	170.82866	118.06565	62.32207
279	0	100.2073	27.87199	140.29022	245.743352	226.55487	170.81089	118.05856	62.31458
279	0.75	111.9528	14.39672	156.73392	273.780524	225.88837	207.09493	115.15424	86.3608
279	1.5	118.972	0.9214461	166.5608	290.746336	236.1753061	234.3324139	107.9962461	106.1533539
279	2.25	118.655	-12.55383	166.117	289.90592	222.03379	247.14145	94.23567	119.34333
279	3	113.6117	-26.0291	159.05632	277.999304	198.84573	250.50393	76.22143	128.2796
280	0	113.6188	-26.02891	159.06632	278.018976	198.86141	250.91923	76.22301	128.28563
280	0.75	38.60057	-39.48544	54.040798	94.699804	37.062194	116.053074	-4.754927	74.235953
280	1.5	-41.14392	-52.96198	-57.601488	99.69068	-133.783544	-27.859594	-89.991508	15.932452

280	2.25	-128.2247	-88.75967	-66.42851	-179.51458	-311.885112	-319.03782	-186.2008	-181.83074	-48.97372
280	3	-220.0317	-169.4455	-79.89504	-308.0438	-535.15084	-513.37858	-353.5885	-277.92357	-118.13349
281	0	-219.3323	-168.7351	79.13523	-307.06522	-533.17492	-352.79863	-511.06909	-118.26384	-276.5343
281	0.75	-133.5158	-103.117	65.82301	-186.92212	-325.20616	-197.51295	-329.15897	-54.34121	-185.98723
281	1.5	-52.42559	-40.87384	52.51076	-73.395826	-128.308852	-51.273768	-156.295328	5.327749	-99.693811
281	2.25	21.32839	15.74429	39.19855	29.859746	50.784922	80.536908	2.139808	58.394101	-20.002999
281	3	90.35612	68.98742	25.88632	126.498568	218.807216	203.301084	151.528444	107.206828	55.434188
282	0	90.35591	68.98582	25.88651	126.498274	218.804404	203.299422	151.520492	107.205829	55.433809
282	0.75	98.35789	74.93905	12.74108	137.701046	237.931948	205.709558	180.227438	101.263181	75.781021
282	1.5	101.6336	77.51727	-0.4043408	142.28704	245.987952	199.0732492	199.8819308	91.0658992	51.8745808
282	2.25	97.57309	74.47048	-13.54976	136.602326	236.240476	178.008428	205.107948	74.266021	101.365541
282	3	88.78632	68.0487	-26.69519	124.300848	215.421504	147.857094	201.287474	53.212498	106.602878
283	0	88.78691	68.05058	-26.69503	124.301674	215.42522	147.899842	201.289902	53.213189	106.603249
283	0.75	18.83938	14.23524	-39.74241	26.375132	45.38364	-2.899914	76.584906	-22.786958	56.697852
283	1.5	-55.83441	-42.9551	-52.78979	-78.168174	-135.729452	-162.746182	-57.166602	-103.040759	2.538821
283	2.25	-137.8445	-105.7704	-65.87716	-192.9823	-334.64604	337.02098	-205.34652	-189.89723	-58.22287
283	3	-224.5807	-171.9608	-78.88456	-314.41298	-544.63412	-520.3422	-362.57308	-281.00719	-123.23807
284	0	-224.3042	-171.7696	79.38431	-314.02582	-543.5964	-361.55033	-520.31895	-122.46947	-281.25809
284	0.75	-130.7921	-100.146	66.23593	-183.10894	-317.18412	-190.86059	-323.33245	-51.47696	100.94882
284	1.5	-42.00623	-31.69732	53.08756	-58.80722	-101.443188	-29.217236	-135.393356	15.281953	-90.893167
284	2.25	39.44336	30.72633	39.93918	55.220704	96.49416	117.997542	38.119182	75.438204	-4.440156
284	3	116.1667	89.97499	26.7908	162.63338	283.350024	256.16583	202.58423	131.34083	77.75923
285	0	116.1601	89.96828	26.79123	162.62414	283.341368	256.15163	202.56917	131.33532	77.75286
285	0.75	122.5606	94.34375	13.71424	171.58484	298.02272	255.13071	227.70223	124.01878	96.5903
285	1.5	124.2349	95.34422	0.6372544	173.92886	301.632632	245.0633544	243.7888456	112.4486644	111.1741556
285	2.25	118.5729	90.71968	-12.43974	166.00206	287.438968	220.56742	245.4469	94.27587	119.15535
285	3	108.1846	82.72015	-25.51673	151.45644	262.17376	187.02494	238.0584	71.84941	122.88287
286	0	108.1929	82.72821	-25.51637	151.47005	262.196616	187.04332	238.07606	71.85724	122.88998
286	0.75	26.96208	19.4506	-38.71774	37.774912	63.499456	13.111356	90.546636	-14.433868	63.001612
286	1.5	-58.85503	-47.20201	-51.9191	-82.537042	-146.269252	-169.867146	-66.028945	-104.978627	-1.140427
286	2.25	-152.2284	-119.4796	-65.12047	-213.11976	-373.84144	-367.27415	-237.03321	-202.12603	-71.88509
286	3	-250.228	-195.1322	-78.32183	-350.3192	-612.68512	-573.72763	-417.08397	-303.52703	-146.98337
287	0	-250.7316	195.8377	79.80666	-351.02424	-614.21824	-416.90996	-576.52128	-145.65278	-305.4641
287	0.75	-152.408	-119.2265	66.0268	-213.3712	-373.652	-236.0893	-368.1429	-71.1404	-203.194
287	1.5	-58.81073	-45.99029	52.24794	-82.335022	-144.15734	-64.315226	-168.811106	-0.681717	-105.177597
287	2.25	27.4503	21.62091	38.46908	38.43042	67.533816	93.03035	16.09219	63.17435	-13.76381
287	3	108.9851	85.85711	24.69021	152.57914	268.153496	241.32944	191.94902	122.7768	73.39638
288	0	108.9766	85.84857	24.68998	152.56724	268.129632	241.31047	191.93051	122.76892	73.38896
288	0.75	119.7717	95.92359	11.02205	167.68038	295.763784	249.77168	227.72758	118.81658	96.77248

288	1.5	125.8405	100.8236	-2.84488	176.1767	312.32636	249.18632	254.47509	115.90232
288	2.25	124.5731	100.9966	-16.31381	174.40234	311.08548	234.17251	266.52213	128.4296
288	3	118.5794	97.79866	-29.98174	166.01116	298.773136	210.1122	270.07568	136.7032
289	0	118.5861	97.80564	-29.98166	166.02054	298.792344	210.1273	270.09062	136.70915
289	0.75	42.38363	40.02177	-43.52444	59.337082	114.895188	47.357686	34.406566	81.669707
289	1.5	-38.54511	-21.13709	-57.06722	-53.963154	-80.073476	-124.458442	-10.324002	22.376621
289	2.25	-126.8101	-87.92095	-70.61001	-177.53414	-292.84564	-310.70308	-169.48306	-43.51908
289	3	-219.8013	-158.0798	-84.15279	-307.72182	-516.68924	-505.99415	-337.68657	-113.66838
290	0	-217.9914	-154.3683	71.98063	-305.18796	-508.57896	-343.57735	-487.93661	-268.17289
290	0.75	-135.1587	-96.95477	61.56934	-189.22218	-317.318072	-197.57587	-320.71455	-183.21217
290	1.5	-57.05215	-42.91625	51.15805	-79.87301	-137.12858	-60.22078	-162.53658	-102.504985
290	2.25	13.71811	5.497263	40.74677	19.205354	25.2573528	62.705765	-18.78775	-28.400471
290	3	79.76212	50.53578	30.33548	111.666968	176.571792	176.585804	-15.914844	41.450428
291	0	73.76265	50.53563	30.33682	111.667124	176.5722	176.587642	15.91402	41.449574
291	0.75	89.64131	53.88648	21.16894	125.497834	193.78794	182.624992	-40.28712	59.508239
291	1.5	94.79372	53.86234	12.00106	132.711208	199.932208	179.615954	55.613744	73.313288
291	2.25	57.60987	48.2132	2.83318	129.653813	188.272964	162.178224	55.511864	80.515703
291	3	63.69978	39.18508	-6.3347	119.979692	165.542232	135.694098	-45.353498	83.464502
292	0	85.69778	39.18801	-6.34961	119.976892	165.538152	135.690365	-48.363067	83.462963
292	0.75	33.05593	10.16977	-16.28775	48.278302	55.938748	33.549136	55.124636	46.038087
292	1.5	-24.31218	-22.22347	-26.24054	-34.037052	-64.732168	-77.638626	-25.157546	4.359578
292	2.25	-89.01653	-60.24171	-36.19333	-124.623142	-203.206572	-203.254976	-30.868216	-43.921547
292	3	-158.4471	-101.6349	-46.14613	-221.82594	-352.75236	-337.91755	-245.62529	-96.45626
293	0	-155.383	-101.567	117.6254	-217.5362	-348.9668	-170.4012	-405.652	-257.4701
293	0.9	-75.47603	-44.07557	71.63866	-105.666442	-161.092148	-63.008146	-206.285466	-139.567087
293	1.5	-3.502398	7.583856	25.65196	-4.9033572	7.531292	29.0329384	-22.2709816	-28.8041182
293	2.7	56.02783	49.52328	-20.33474	78.438962	145.470644	96.421936	-37.091416	70.759787
293	3.6	107.6247	85.63071	-66.32145	150.67459	266.158776	148.4589	281.1019	163.18362
294	0	107.6273	85.63096	66.32057	150.67822	266.162296	148.46305	281.10439	163.16524
294	0.9	88.99609	69.94121	-103.4343	124.594526	218.701244	73.302218	280.170818	163.530781
294	1.8	62.59155	48.47987	-140.548	87.50217	152.569652	-17.06627	264.02373	196.799395
294	2.7	24.97401	18.5145	-177.6677	34.963614	59.592012	-129.178388	226.145012	200.138209
294	3.6	-19.30768	-16.26828	-214.7753	-27.030752	-49.195464	-254.210796	175.339804	197.398388
295	0	-18.67561	-16.07843	102.7379	-26.145854	-48.13222	64.248738	-141.227062	-119.545949
295	0.9	24.58834	19.15963	81.64453	34.423676	60.161416	130.310166	-32.978892	-59.515024
295	1.8	61.09814	49.58227	60.55115	85.537396	152.6494	183.451188	62.348888	-5.562824
295	2.7	86.57494	71.50088	39.45777	121.204916	218.251336	214.846578	135.53038	38.459676
295	3.6	104.1984	87.6479	18.36438	145.66376	265.26272	231.03836	194.3096	75.40518
296	0	104.1898	87.64966	18.365	145.86572	265.267216	231.04242	194.31242	75.40582

296	0.9	61.21861	53.40105	1.399628	85.706054	156.904012	128.26301	125.463754	56.496377	53.697121
296	1.8	10.31408	13.32045	-15.56574	14.439712	33.689615	10.131606	41.263086	-6.283068	24.848412
296	2.7	-53.03385	-36.48015	-32.53111	-74.24739	-122.00866	-132.65188	-67.55966	80.261575	-15.195355
296	3.6	-124.3151	-92.11275	-49.49648	-174.04114	-296.55852	-290.78735	-151.79439	-161.38007	-62.38711
297	0	127.3524	-91.49748	36.02393	-178.29336	-299.218848	-208.29653	-280.34419	-78.59333	-150.64099
297	0.75	-76.12742	-57.06506	29.53764	-106.578388	-182.657	-118.860324	-177.955604	-38.977038	-98.052318
297	1.5	-29.62863	-26.00765	23.05145	-41.480082	-77.166596	-38.510556	-84.613456	-3.614317	49.717217
297	2.25	9.533903	-0.5752277	16.56526	13.3474642	10.52031928	27.4307159	-5.6998041	25.1457727	-7.9847473
297	3	43.97019	21.48219	10.07906	61.558265	87.135732	84.325478	64.167358	49.652231	29.494111
298	0	43.96835	21.47941	10.07901	61.55569	87.129076	84.32044	64.16242	49.650525	29.492505
298	0.75	61.99596	36.78811	3.592834	86.794344	133.256128	114.776096	107.590428	59.389198	52.20353
298	1.5	75.29732	48.72181	-2.893343	105.416248	168.31158	136.185251	141.971937	64.874245	70.660931
298	2.25	81.26243	55.03051	-9.37952	113.767402	185.563732	143.165906	161.924946	63.756667	82.515707
298	3	92.50129	57.95421	15.8657	115.501806	191.744284	141.100058	172.831458	58.385461	90.116861
299	0	82.49798	57.96233	-15.86487	115.497172	191.737304	141.095036	172.824776	58.383312	90.113052
299	0.75	39.59737	28.07578	-21.88875	55.436316	92.438092	53.703874	97.461374	13.748883	57.526383
299	1.5	-8.029485	-5.185758	-27.91262	-11.241279	-17.9325948	-42.73376	13.09148	-35.1391565	20.6860835
299	2.25	-62.99259	-44.0723	-33.93955	-88.189626	-146.106788	-153.599908	-85.726906	-90.629831	-22.756831
299	3	-122.6819	-86.33385	-39.96037	-171.75466	-285.35244	-273.5125	-193.69176	-150.37408	-70.45334
300	0	-118.0947	-84.57616	42.58354	-165.35255	-277.035496	-183.70326	-268.87334	-63.70169	-148.66877
300	0.75	-73.57302	-51.77273	35.47877	-103.002228	-171.123992	-104.581584	-175.539124	-30.736948	-101.694488
300	1.5	-33.77759	-22.3443	28.37399	-47.288626	-76.283988	-34.503418	-91.251398	-2.025841	-58.773821
300	2.25	-1.318409	1.459131	21.26922	-1.8457726	0.7525188	21.1462602	-21.3921798	20.0826519	-22.4557881
300	3	26.41452	21.88756	14.16445	36.980328	66.71752	67.749434	39.420534	37.937518	9.608618
301	0	26.41611	21.88717	14.16467	36.982554	66.718804	67.751172	39.421832	37.939169	9.609829
301	0.75	37.74017	29.94198	7.059175	52.836238	93.195372	82.289359	68.171099	41.025328	26.906978
301	1.5	44.33798	34.62179	-1.635-02	62.073172	108.60044	87.78104593	87.87368607	39.85786193	35.35050207
301	2.25	43.59555	33.6766	-7.151815	61.03937	106.20202	78.844245	93.147875	32.08778	46.39141
301	3	38.13486	29.35641	-14.25731	53.388804	92.732088	60.860932	89.375552	20.064064	48.578684
302	0	38.13316	29.35666	-14.25722	53.386424	92.730448	60.859232	89.373672	20.062624	48.577064
302	0.75	16.26118	12.86393	-21.36238	22.769632	39.775704	10.814965	53.539726	-6.727319	35.997442
302	1.5	-10.33706	-7.403796	-28.46753	-14.471884	-24.2505456	-49.275798	8.659262	-37.770884	19.164176
302	2.25	-44.27155	-35.09652	-35.57268	-61.96317	-106.080292	-121.79506	-50.6497	-75.417075	-4.271715
302	3	-82.93228	-62.16425	-42.67784	-116.105192	-198.981536	-204.360826	-119.005146	-117.316892	-31.961212
303	0	-51.15109	-60.47318	40.29132	-113.611526	-194.138396	-117.503168	-198.145808	-32.744661	-113.327301
303	0.75	-44.79819	-33.51333	33.56168	-62.717466	-107.379156	-53.709478	-120.832838	-6.756691	-73.880051
303	1.5	-13.17151	-9.928483	26.83204	-18.440156	-31.6914208	1.097703	-52.566371	14.977654	-38.686426
303	2.25	1.11886	6.031367	20.10241	15.566404	26.1328192	41.476409	1.271589	30.109384	-10.095436
303	3	30.68301	22.61622	13.37277	42.956214	73.005364	72.808602	45.063062	40.937479	14.241839

304	0	30.68574	22.6169	13.3725	42.96033	73.009766	72.812188	38.65131	40.959666	14.24466
304	0.75	33.84175	24.82844	6.643053	47.37844	80.335604	72.081593	58.19417	37.10063	23.54422
304	1.5	32.27151	23.66508	-6.64E-02	45.18014	76.58994	62.30450107	64.4772423	28.9576807	19.1014693
304	2.25	23.36503	16.87671	-6.815835	32.71104	55.040772	38.098911	51.73551	14.712692	2.844362
304	3	9.732291	6.713353	-13.54528	13.62520	22.420114	4.8468222	31.957152	-4.7862181	22.3043419
305	0	9.730072	6.713224	-13.54556	13.6221008	22.4172448	4.8437504	31.954374	-4.7884952	22.3026248
305	0.75	-20.31309	-15.82496	-20.27523	-28.43926	-49.595644	-60.475948	-19.52533	-38.557061	1.953499
305	1.5	-55.08251	-41.73815	-27.00489	-77.115514	-132.880052	-134.842152	-90.83112	-76.579249	-22.569269
305	2.25	-97.18817	-73.27634	-33.7347	-136.06343	-233.857948	-223.636844	-136.16444	-121.204053	-53.734653
305	3	-144.0201	-108.1895	-40.46441	-201.62814	-345.92732	-321.47803	-240.54921	-170.0825	-69.15368
306	0	-153.3755	-115.2253	42.54626	-214.7257	-368.41108	-256.72964	-341.82215	-95.49169	-18C.56421
306	0.75	-77.52886	-58.21773	35.37333	-106.54040	-186.183	-115.87903	-196.625692	-34.402644	-105.145304
306	1.5	-6.408419	-4.565134	28.2004	-8.9717866	-15.0263172	15.9251632	-43.4756363	22.4328229	-33.9575771
306	2.25	57.37577	43.42246	21.02747	60.326873	138.32686	133.300854	91.245914	72.665653	30.610723
306	3	116.4337	88.05505	13.85454	163.00715	280.60852	241.63003	213.92095	118.64487	50.93579
307	0	116.4465	88.0647	13.85547	163.0251	280.63932	241.65597	213.94503	118.65732	50.94638
307	0.75	119.1228	89.89938	6.948765	169.77152	286.784768	239.754505	225.895975	114.159285	100.261755
307	1.5	117.0729	85.35706	4.21E-02	163.90233	281.854776	228.886597	228.8024821	105.4076679	105.3235521
307	2.25	107.6867	81.19073	-6.86465	153.76133	259.129208	203.55012	217.27942	90.05338	103.76268
307	3	93.57431	70.64941	-13.77136	131.064034	225.328225	169.167222	196.709942	70.445519	97.588239
308	0	93.56939	70.64588	-13.77021	130.997145	225.316676	169.158938	196.699358	70.442241	97.582561
308	0.75	33.18832	25.44462	-20.72999	45.463645	80.537376	44.546614	85.994594	9.145498	50.593476
308	1.5	-31.91901	-23.13164	-27.67777	-4.686614	-75.313436	-89.112222	-33.756682	-56.404879	-1.049339
308	2.25	-104.3626	-77.3329	-34.63156	-146.10764	-248.96776	-237.19958	-167.93646	-128.5579	-59.29478
308	3	-181.5324	-134.9092	-41.58534	-254.14536	-433.6936	-394.33342	-311.16274	-204.9645	-121.79362
309	0	-176.6352	-130.9776	41.81721	-247.29465	-421.5312	-301.12743	-384.76185	-117.15807	-200.79249
309	0.75	-110.6061	-82.43084	34.69902	-154.84854	-264.616664	-180.45914	-249.85719	-64.24647	-134.24451
309	1.5	-49.29926	-37.25912	27.58062	-69.018954	-118.773704	-68.837412	-123.999052	-16.788514	-71.950154
309	2.25	4.671332	2.287604	20.46263	6.539654	9.2657648	28.3559324	-12.5694276	24.6668286	-16.2584312
309	3	53.91568	39.45532	13.34443	75.481952	126.23728	116.502566	89.813706	61.868542	35.176682
310	0	53.91538	38.45806	13.34512	75.481532	126.231384	116.501656	89.811416	61.868962	35.178722
310	0.75	62.93126	45.36033	6.526073	66.103764	148.09404	127.43915	114.351769	63.164207	50.112061
310	1.5	67.22088	48.88758	-0.292577	94.109232	158.885184	129.2596589	129.8456131	60.2058149	60.7917691
310	2.25	64.17426	46.78984	-7.112028	89.843954	151.872856	116.686924	130.91098	50.644806	64.868862
310	3	56.40139	41.31709	-13.93108	76.961946	133.789012	95.067678	122.929838	36.830171	64.692331
311	0	56.40173	41.31847	-13.93048	76.964422	133.791628	95.070066	122.931026	36.831077	64.692037
311	0.75	8.480636	6.581867	-21.1539	11.8731704	20.7079904	-4.3950298	37.9127702	-13.5211476	28.766624
311	1.5	-44.16631	-31.52973	28.37731	-61.832834	-103.44714	-112.906612	-58.151992	-68.126989	-1.372369
311	2.25	-104.1497	-75.26633	-35.60072	-145.80958	-245.405768	-235.84669	-164.64525	-123.33545	-58.13401

311	3	-163,8593	-122,3779	-42,82414	-236,40302	-398,4358	-367,8332	-282,18452	-194,79751	-109,14923
312	0	-174,44	-126,3065	40,30594	-242,216	-411,4184	-295,32856	-375,94044	-116,69006	-197,30194
312	0,83	-98,02693	-70,93784	33,44576	-137,23702	-231,13286	-155,124396	-222,015916	-54,778477	-121,669997
312	1,67	-27,44861	-19,7358	26,56558	-38,426054	-64,515612	-26,086552	-79,259712	1,881831	-51,289329
312	2,50	34,07279	24,52194	19,7254	47,701906	80,122452	85,134688	45,683888	50,390111	10,940111
312	3,33	89,75943	64,61311	12,86522	125,663202	211,092292	185,189546	159,459206	93,648707	67,918267
313	0	89,7593	64,61159	12,86591	125,66302	211,089704	185,18866	159,45684	93,64928	67,91746
313	0,63	100,1229	72,24467	6,44242	140,17206	233,738952	198,840392	185,943908	96,558852	83,662368
313	1,67	104,6517	75,71116	3,06E-02	146,51238	246,719896	201,3237722	201,2626278	94,21710221	94,15595775
313	2,50	100,1236	72,23335	-6,387097	140,17304	235,72168	185,994573	198,768767	83,724143	96,498337
313	3,33	89,76081	64,58895	-12,80477	125,665134	211,055292	159,497152	185,106692	67,979959	93,589499
314	0	89,76094	64,59047	-12,80407	125,665316	211,05788	159,499528	185,107688	67,980776	93,588916
314	0,83	34,07339	24,48573	-19,68267	47,702746	80,063236	45,691128	85,056468	10,983381	50,348721
314	1,67	-27,44927	-19,78585	-26,55128	-38,425978	-64,596484	-79,286254	-26,163694	-51,255623	1,856937
314	2,50	-98,0294	-71,00214	-33,43988	-137,24116	-231,238704	-222,0773	-155,19754	-121,66634	-54,78658
314	3,33	-174,4446	-126,3853	-40,31849	-244,22244	-411,55	-376,03731	-295,40033	-137,31863	-116,60165
315	0	-168,8541	-122,2943	43,02596	-256,39574	-398,2958	-281,89326	-367,94516	-108,94273	-194,99465
315	0,75	-104,1453	-75,19672	35,77956	-145,83342	-245,289112	-16,139152	-235,95064	-57,95121	-129,51033
315	1,5	-44,16271	-31,47413	28,53216	-61,827794	-103,35386	-55,936222	-113,002542	-11,213279	-66,279599
315	2,25	8,483592	6,62346	21,28676	11,8770288	20,7778464	38,0905304	-4,4829896	28,9219928	-13,6515272
315	3	56,40364	41,34605	14,04036	78,965096	133,838048	123,070778	94,990058	64,803636	36,722916
316	0	56,40331	41,34467	14,04095	78,964634	133,835444	123,069592	94,987692	64,803929	36,722029
316	0,75	64,17528	46,80431	7,179812	89,645392	151,897232	130,994458	116,634834	64,937564	50,57794
316	1,5	67,22099	48,88895	0,3186786	94,109386	158,887508	129,8728166	129,2354594	60,8175696	60,1802124
316	2,25	62,93047	45,34859	-6,542455	88,102658	148,074308	114,322699	127,407609	50,094968	63,179876
316	3	53,91363	38,43322	-13,40359	75,479166	126,18959	89,726058	116,53238	35,118731	61,925911
317	0	53,91399	38,43447	-13,40295	75,479586	126,19194	89,728308	116,534208	35,119641	61,925541
317	0,75	4,668869	2,249007	-20,56483	6,5364166	9,201054	-12,7131802	28,4164798	-16,3628479	24,7668121
317	1,5	-49,3025	-37,31146	-27,72671	-69,0235	-118,861336	-124,20117	-68,74775	-72,09896	-16,64554
317	2,25	-110,6101	-82,49612	-34,88953	-154,85414	-264,727192	-250,11762	-180,34046	-134,43767	-64,66051
317	3	-176,644	-131,0574	-42,05046	-247,3016	-421,66464	-385,03066	-300,97974	-201,03005	-116,92914
318	0	-181,5271	-134,6239	41,86431	-254,13794	-433,55076	-310,79211	-394,52073	-121,51008	-205,2387
318	0,75	-104,358	-77,26252	34,74408	-146,1012	-248,850272	-167,74844	-237,2356	-59,17812	-128,66628
318	1,5	-31,91522	-23,0769	27,62385	-44,681308	-75,221304	-33,751314	-88,959014	-1,099848	-56,347548
318	2,25	33,19136	25,48413	20,50362	46,467904	80,60424	85,817382	44,810142	50,375844	9,368604
318	3	33,57169	70,67014	13,3834	131,000366	225,358252	196,339568	169,572768	97,597921	70,831121
319	0	93,57661	70,67368	13,38429	131,007254	225,36982	196,349902	169,581322	97,603239	70,834659
319	0,75	107,6879	81,19978	6,86272	150,75306	259,145128	217,011532	203,89898	103,505382	90,332838
319	1,5	117,073	88,35089	-0,2114742	163,9022	281,849024	228,6267428	229,0502372	105,1539528	105,5774472

319	2.25	119.1218	89.877	-7.069760	166.77552	286.74555	225.813394	239.832526	100.169354	114.219386
319	3	115.4444	88.02811	-13.80779	163.02215	280.578255	213.9536	241.56918	90.99217	118.60775
320	0	116.4315	88.01846	-13.80667	163.024	280.547335	213.92959	241.54253	90.98168	118.59502
320	0.75	57.37159	43.36946	-20.55015	80.320226	138.237044	91.665218	32.765518	31.084281	72.184581
320	1.5	-6.414629	-4.654535	-27.29363	-8.9804896	-15.1448108	-39.6457198	4.9415402	-33.0667961	21.5204639
320	2.25	-77.53709	-58.30354	-24.03712	-108.551926	-186.330172	-185.385168	-17.310928	-103.820501	-35.746261
320	3	-153.3858	-115.3275	-40.7806	-214.74012	-368.58596	-340.17106	-258.60986	-178.82782	-97.26662
321	0	-144.0202	-108.1312	43.30964	-201.62828	-345.83416	-237.6458	-324.26508	-86.30854	-172.92782
321	0.75	-97.18735	-73.22035	36.05756	-136.06229	-233.77738	-153.78761	-225.90273	-51.411055	-123.526175
321	1.5	-55.08078	-41.68452	28.80549	-77.113052	-132.792168	-78.975966	-36.586946	-20.767212	-78.378192
321	2.25	-20.31046	-15.7737	21.55341	-28.434644	-49.610472	-18.592842	-51.699662	3.273996	-39.832824
321	3	9.733616	6.762127	14.30134	13.6270624	22.4997424	32.7438062	4.1411262	23.0815944	-5.5410856
322	0	9.755833	6.762253	14.30155	13.6301562	22.5026544	32.7468026	4.1437026	23.0637997	-5.5393003
322	0.75	23.36948	16.92325	7.048506	32.717274	55.120576	52.015582	37.91766	28.081498	13.983566
322	1.5	32.27887	23.70925	-0.2036203	45.187618	76.667544	62.2378737	62.6451143	28.8455627	29.2528033
322	2.25	33.84801	24.87025	-7.456206	47.387214	80.410512	58.031655	72.944068	23.007003	37.919415
322	3	30.60291	22.65626	-14.70879	42.970074	73.061535	44.778962	74.195542	12.914829	42.332409
323	0	30.69018	22.65568	-14.70863	42.966252	73.077354	44.775266	74.192525	12.912532	-2.329792
323	0.75	11.12694	8.068474	-21.96086	15.577716	25.2516554	-0.540058	43.381662	-11.946614	31.975106
323	1.5	-13.16254	-9.893727	-29.21309	-18.427556	-31.6250112	-54.901665	3.524315	-41.059376	17.366804
323	2.25	-44.78828	-33.48093	-36.46932	-62.703592	-107.315424	-123.692186	-50.761546	-76.774772	-3.844132
323	3	-81.14027	-60.44313	-43.71756	-113.596376	-194.077332	-201.528014	-114.093894	-116.743803	-29.308683
324	0	-2.91128	-61.92957	40.44144	-116.07592	-198.580848	-120.981666	-201.864546	-34.178712	-115.061592
324	0.75	-44.25531	-32.94592	33.63923	-61.957434	-105.819544	-52.413062	-19.691522	-6.190549	-73.469009
324	1.5	-10.32559	-7.337262	26.83702	-14.455826	-24.1303272	7.10905	-46.56499	17.543959	-36.130051
324	2.25	16.26788	12.64639	20.03481	22.775032	39.75568	52.202656	12.133036	34.675902	-5.393718
324	3	38.1351	29.25505	13.2326	53.38914	92.5702	98.24977	61.78457	47.65419	21.08899
325	0	38.13681	29.25482	13.23227	53.391534	92.571864	88.251262	51.786722	47.565399	21.090859
325	0.75	43.59673	30.49093	6.430254	61.035422	105.901564	92.23726	79.376752	45.667311	32.806803
325	1.5	44.3304	34.55204	-0.3717619	62.06255	108.195744	87.1767581	67.9202819	39.5255981	40.2691219
325	2.25	37.12783	29.58815	-7.175779	32.816862	92.614436	67.507767	82.075325	26.781268	41.128826
325	3	26.399	21.4927	-13.97579	36.9566	65.597632	39.15228	67.10386	9.78331	37.73469
326	0	26.39742	21.49066	-13.97608	36.956388	65.59636	39.150484	67.102644	9.781598	37.733758
326	0.75	-1.340292	0.9371243	-20.77823	-1.8764088	-0.10895152	-21.4494561	20.1070039	-21.8844928	19.5719672
326	1.5	-33.80425	-22.95041	-27.58038	-47.32595	-77.265756	-91.09589	-35.93513	-58.004205	-2.843445
326	2.25	-73.60446	-52.46294	-34.38253	-103.046244	-172.266056	-175.170822	-106.405762	-100.626544	-31.861484
326	3	-118.1309	-85.35048	-41.18466	-165.38326	-278.217848	-268.29224	-185.92288	-147.50249	-65.13313
327	0	-122.682	-87.14605	42.48246	-171.7548	-286.65208	-191.88199	-276.84691	-67.93134	-152.89626
327	0.75	-63.0308	-44.47216	35.76974	-88.24312	-146.792416	-84.33935	-155.87686	-20.95738	92.49746

327	1.5	-8.105863	-5.17327	29.05701	-11.3482082	-16.0042676	14.1567044	-43.9573156	21.7617333	-56.5512567
327	2.25	39.48282	28.50062	22.34429	55.275948	92.960376	98.224234	52.535714	57.878828	13.193249
327	3	82.34526	58.79951	15.63157	115.283364	192.893528	173.246392	141.982252	89.742304	58.479164
328	0	82.34853	58.80128	15.63162	115.287942	192.900284	173.251136	141.987896	89.745297	58.482057
328	0.75	81.10248	56.34314	9.360266	113.543472	187.472	163.026382	144.30585	82.352498	63.631966
328	1.5	75.13017	50.50999	3.088916	105.182238	170.972188	143.75511	137.577278	70.706069	64.528237
328	2.25	61.82162	39.05185	-3.182433	86.550268	136.668904	110.055361	116.420227	52.457025	58.821891
328	3	43.78682	24.2187	-9.453783	61.301548	91.294104	67.309101	86.216667	29.954355	48.861921
329	0	43.7886	24.22151	-9.453888	61.30404	91.300736	67.313942	86.221718	29.955852	48.863628
329	0.75	9.345175	2.639786	-15.72602	13.083245	15.4378676	-1.872024	29.580016	-7.3153625	24.1366775
329	1.5	-29.82451	-22.31694	-21.99816	-41.754314	-71.496516	-80.104512	-36.108192	-48.840219	-4.843899
329	2.25	-76.33044	-52.89887	-28.27029	-106.862616	-176.3344	-172.765488	-116.224908	-96.967686	-40.427106
329	3	-127.5325	-85.85539	-34.54243	-178.58764	-292.043744	-274.47294	-205.38808	-149.34877	-60.26391
330	0	-124.8319	-85.81965	53.80787	-174.76466	-287.10972	-181.81006	-289.4258	-58.54084	-166.15658
330	0.9	-53.15848	-35.06479	34.01107	-74.421974	-119.89384	-54.843896	-32.866036	-13.831562	-81.853702
330	1.8	10.58161	9.858075	14.21428	14.814254	28.470852	36.770287	8.341727	23.737729	-4.690831
330	2.7	61.8783	45.06094	-5.582513	86.62962	146.351464	113.732387	124.897413	50.107957	61.272983
330	3.6	105.2417	74.4318	-25.37931	147.33838	245.38092	175.34253	226.10115	69.33822	120.09664
331	0	105.2405	74.43018	-25.37875	147.3367	245.376855	175.34003	226.09753	69.3377	120.0952
331	0.9	87.5386	61.95301	-46.72712	122.55404	204.235136	120.31221	213.76645	32.05762	125.51186
331	1.8	61.9734	43.78425	-68.07548	86.76276	144.42288	50.57685	186.22781	-12.29942	123.85154
331	2.7	25.3752	17.07146	-89.42384	35.52528	57.764576	-41.90214	136.94554	-66.58616	112.26152
331	3.6	-17.97715	-14.45674	-110.7722	-25.16801	-44.703364	-146.80152	74.74288	-126.951635	94.592765
332	0	-10.73422	-10.04721	28.95674	-15.027908	-28.9566	6.028466	-51.885014	19.295942	-38.617538
332	0.9	22.81756	22.06896	22.65426	31.944584	62.691408	72.104292	26.795772	43.190064	-2.118456
332	1.8	52.05186	51.26913	16.35179	72.872604	144.49284	130.083152	97.379572	63.198464	30.494884
332	2.7	74.86916	75.60931	10.54931	104.816824	210.817688	175.501612	155.402992	77.431554	57.332934
332	3.6	93.36899	97.03348	3.746832	130.716586	267.296356	212.8231	205.329436	87.778923	80.285259
333	0	93.30365	96.98289	4.683656	130.62511	267.137004	213.630926	204.263614	98.656941	79.289629
333	0.9	41.49642	47.86982	1.382326	58.034988	126.387416	99.047852	96.283156	38.729106	35.96445
333	1.8	-14.6283	-4.159239	-1.918999	-20.47962	-24.206726	-23.632217	-19.794219	-15.084469	-11.246471
333	2.7	-77.17001	-61.04834	-5.220326	-108.038014	-190.281356	-158.872678	-148.432026	-74.673335	-64.232683
333	3.6	-144.0292	-120.8534	-8.521653	-201.64088	-366.20048	-302.210093	-285.166787	-138.147933	-121.104627
343	0	-147.7869	-122.3858	21.51384	-206.90166	-372.68156	-277.91624	-320.94392	-111.49437	-154.52205
343	0.75	-80.66254	-71.08055	17.57554	-112.927556	-210.523928	-150.300058	-185.451138	-55.020746	-90.171826
343	1.5	-16.17189	-21.76284	13.63723	-27.640646	-54.226812	-27.531878	-54.806338	-0.917471	-28.191931
343	2.25	44.47001	24.74237	9.698923	62.258014	92.951804	87.805305	68.407459	49.721932	30.324086
343	3	102.4782	69.56009	5.760616	143.46948	234.263984	198.294546	186.773314	97.990996	86.469764
345	0	102.3112	69.43	8.199878	143.23568	233.86144	200.403318	184.003662	100.273958	83.980202

345	0.75	105,2246	73,86791	3,125156	147,31444	244,458176	203,262566	197,012274	97,627296	91,576564
345	1.5	105,5043	76,61833	-1,945566	147,70602	249,194488	201,273924	205,173356	93,004304	96,903436
345	2.25	101,9352	76,55625	-7,024288	142,70928	244,81224	191,854202	205,952778	94,717392	98,765968
345	3	95,73241	74,80667	-12,09901	134,025374	234,569564	177,586552	201,784572	74,060159	98,258179
346	0	95,78986	74,85236	-9,704009	134,105804	234,711608	180,096183	199,504231	76,506865	95,914883
346	0.75	28,69935	21,73149	-10,82976	40,17909	69,209604	45,34095	67,00047	14,999655	36,659175
346	1.5	-41,02491	-33,07689	-11,95552	-57,434874	-102,152916	-94,262302	-70,351262	-48,877939	-24,966899
346	2.25	-114,5979	-90,69776	-13,08127	-160,43706	-282,633696	-241,29651	-215,13397	-116,21938	-90,05684
346	3	-190,8047	-150,0061	-14,20703	-267,12658	-468,9754	-393,17877	-364,76471	-185,93126	-157,5172
347	0	-188,1515	-148,669	18,43232	-263,4121	-463,6522	-356,01848	-392,86312	-150,90403	-187,76867
347	0.75	-116,39	-91,06953	14,72397	-162,946	-285,379248	-216,01356	-245,4615	-90,02703	-119,47497
347	1.5	-47,26229	-35,15755	11,01561	-66,187206	-112,966828	-80,856688	-102,887908	-31,520451	-53,551671
347	2.25	18,01671	17,94193	7,307259	25,223394	50,32714	46,869241	32,254723	23,522298	8,90778
347	3	80,66196	69,35392	3,598905	112,926744	207,760624	169,747177	162,549357	76,154669	68,996659
348	0	80,5567	69,26876	6,211486	112,77938	207,498955	172,148286	159,725514	78,712516	66,289544
348	0.75	85,65256	72,36299	2,681172	119,913584	218,563856	177,327234	172,46489	79,768476	74,406132
348	1.5	88,11466	73,76971	-0,849142	123,360524	223,769128	178,65816	180,356444	78,454052	80,152336
348	2.25	86,72802	72,36395	-4,379456	121,419726	219,855944	172,058118	180,81703	73,675762	82,434674
348	3	82,70763	69,27068	-7,90077	115,790682	210,082244	160,610066	176,429556	66,527097	82,346637
349	0	82,80957	69,35294	-5,422343	115,933398	210,336188	163,302061	174,146777	69,10627	79,950956
349	0.75	21,19855	17,91915	-8,418613	29,67797	54,1089	34,938597	51,776223	10,659882	27,497508
349	1.5	-43,04623	-35,20214	-11,41522	-60,264722	-107,9789	-98,272896	-75,442336	-50,156887	-27,326327
349	2.25	-111,1397	-91,13593	-14,41175	-155,59558	-279,185128	-238,91532	-210,09182	-114,43748	-85,61398
349	3	-181,867	-148,7572	-17,40822	-254,6138	-456,25192	-384,40582	-349,58938	-181,08852	-145,27208
350	0	-181,2383	-148,0797	15,81844	-253,73362	-454,41348	-349,47422	-381,3841	-147,29603	-178,93291
350	0.75	-110,6392	-90,91253	12,79854	-154,89488	-278,227088	-210,88103	-236,47811	-86,77674	-112,37382
350	1.5	-42,67382	-35,43287	9,778646	-55,743348	-107,901176	-76,862808	-96,4201	-28,627792	-48,185084
350	2.25	21,44281	17,23429	6,758746	30,019934	53,356236	49,724408	36,203916	26,057275	12,539783
350	3	82,92569	68,21395	3,739847	116,095966	208,653148	171,463625	163,985931	78,371968	70,894274
351	0	82,83752	68,14691	6,07058	115,972528	208,44006	173,622514	161,481354	80,624348	68,483183
351	0.75	96,93954	70,9007	2,766594	121,715356	217,768968	177,994742	172,461554	61,01219	75,478992
351	1.5	88,40761	71,96697	-0,5373914	123,770934	221,236524	177,5189505	178,5937334	79,0296376	90,1044204
351	2.25	86,02732	70,22073	-3,841377	120,438248	215,585994	169,612157	177,294911	73,583211	81,265965
351	3	81,01308	66,78703	-7,145363	113,418312	204,074944	156,857363	171,146089	65,766409	80,057135
352	0	81,1215	66,87762	-4,948034	113,5701	204,349992	159,275386	169,171454	68,061316	77,957384
352	0.75	18,94571	15,37807	-7,159177	26,523994	47,339764	30,953745	45,272099	9,891962	24,210316
352	1.5	-45,96383	-37,00838	-9,37032	-54,209362	-115,530954	-102,215396	-83,475256	-50,647767	-31,907127
352	2.25	-114,5221	-93,80853	-11,58146	-160,33054	-287,520168	-242,81651	-219,66359	-114,65135	-91,48843
352	3	-185,8142	-151,4956	-13,79261	-260,13988	-465,37	-388,26525	-360,65903	-181,02539	-153,44017

353	0	-189,0608	-153,9081	19,08267	-264,68512	-473,12592	-361,69839	-399,86373	-151,07205	-189,23739
353	0,75	-113,6153	-92,94418	15,48096	-159,06142	-285,049248	-213,80158	-244,7635	-66,77281	-117,75473
353	1,5	-40,80355	-33,66783	11,87925	-57,12497	-102,832158	-70,75284	-94,51134	-24,843945	-48,602445
353	2,25	28,15943	22,79603	8,277541	39,423202	70,264564	64,864887	48,309805	33,621026	17,065946
353	3	94,48866	77,57239	4,67583	132,284124	237,502216	195,634612	186,282952	89,715624	80,363964
356	0	94,32422	77,44309	6,949275	132,053908	237,098008	197,581429	183,682879	91,841073	77,942523
356	0,75	98,72247	80,40301	3,104164	138,211456	247,11178	201,974138	195,76581	91,954387	85,746059
356	1,5	100,487	81,67543	-0,7409475	140,6818	251,265088	201,5188825	203,000775	89,6973525	91,1792475
356	2,25	98,40272	80,13535	-4,586059	137,763808	246,259824	193,632555	202,804673	83,976389	93,148507
356	3	93,68472	76,90778	-8,43117	131,158608	235,474112	180,898274	197,760614	75,885078	92,747418
357	0	93,85094	77,04162	-6,255361	131,391316	235,88772	183,407387	195,518109	78,210485	90,721207
357	0,75	29,10826	23,50607	-8,476286	40,751564	72,535624	49,959696	66,912268	17,721148	34,67372
357	1,5	-38,26817	-31,71697	-10,69721	-53,57438	-96,668956	-88,335984	-66,941564	-45,138563	-23,744143
357	2,25	-109,4933	-89,75252	-12,91814	-153,29062	-274,955592	-234,06262	-208,22634	-111,46211	-85,62563
357	3	-183,3523	-149,4756	-15,13906	-258,69322	-459,16372	-384,63742	-354,3593	-180,15613	-149,67801
358	0	-181,0477	-147,5872	18,17845	-253,46678	-453,39576	346,66599	-383,02289	-144,76448	-181,12138
358	0,75	-111,5377	-91,26366	14,69292	-158,15278	-279,867996	-210,41598	-239,80182	-85,69101	-115,07685
358	1,5	-44,8614	-36,62762	11,2074	-62,52596	-112,18772	-79,0139	-101,1287	-28,98785	-51,40266
358	2,25	18,3661	15,19592	7,721671	25,71254	46,352792	44,95111	29,513359	24,251361	6,807619
358	3	78,75986	65,33196	4,236346	110,263804	199,042568	164,080138	155,67446	75,12022	66,647528
359	0	78,66225	65,25362	6,595294	110,12715	198,800492	166,243614	153,053026	77,391319	64,200731
359	0,75	82,3508	67,54061	2,796738	115,29112	207,045536	169,258308	163,664832	76,912458	71,316982
359	1,5	83,4056	68,34011	-1,001818	116,76784	209,430896	167,425012	169,428648	74,063222	76,066858
359	2,25	80,61166	66,2271	-4,800374	112,856324	202,697352	158,160718	167,761466	67,75012	77,350868
359	3	75,18395	62,4266	-8,59893	105,25753	190,1033	144,04841	161,24627	59,066625	76,264485
360	0	75,27044	62,4966	-6,335011	105,378616	190,319088	146,486117	159,156139	61,408385	74,078407
360	0,75	13,11852	10,94154	-8,589121	18,365928	33,249588	18,094641	35,272887	3,217545	20,395791
360	1,5	-51,66715	-42,30102	-10,84324	-72,33401	-129,662212	-115,14484	-93,45836	-57,343675	-35,657195
360	2,25	-120,3016	-98,35608	-13,09735	-168,42224	-301,731648	-255,81535	-229,62065	-121,36879	-95,17409
360	3	-191,5697	-156,0986	-15,35145	-268,19758	-479,6414	-401,3337	-370,63078	-187,76419	-157,06127
361	0	-194,1896	-156,0109	18,02087	-271,86572	-495,8452	-379,01779	-409,05953	-156,74935	-192,79169
361	0,5	-114,6066	-93,86765	14,62837	-160,44924	-287,71616	-216,7672	-246,02394	-88,51757	-117,77431
361	1,67	-38,27496	-31,6077	11,23588	-53,584944	-96,822272	-66,501772	-88,975532	-23,211584	-45,083344
361	2,50	33,30526	26,78008	7,843375	46,627364	82,81444	74,589767	58,903017	37,818109	22,131359
361	3,33	101,634	83,28458	4,450876	142,2876	255,216128	209,696256	200,794504	95,921476	67,019724
362	0	101,4938	83,17394	6,784882	142,09132	254,870964	211,751382	198,181618	98,129302	84,559538
362	0,83	107,1218	86,98856	3,109028	149,67052	267,727856	218,642748	212,426692	99,517648	93,307592
362	1,67	199,4982	88,71987	-0,5688264	153,29748	273,349632	219,548836	220,685364	97,9795536	99,1172064
362	2,50	107,1232	86,97904	-4,245681	149,57246	267,714304	211,281199	219,772561	92,165199	100,656561

351	3.33	101.4968	93.15462	-7.922635	142.08552	254.644032	107.026545	212.873615	63.424555	99.269655
352	0	101.5391	83.27057	-5.652697	142.29474	255.200312	199.555093	210.920487	65.792493	97.157387
353	0.83	33.30809	26.75428	-7.982357	46.631326	82.776556	59.741631	74.706345	21.954924	37.959638
354	1.67	-36.27456	-31.84572	-10.26202	-53.584364	-56.882624	-89.057212	-67.493172	-44.729124	-24.165084
355	2.50	-114.6089	-93.91808	-12.59163	-160.45246	-287.799608	-244.03044	-218.86708	-115.72969	-90.56633
356	3.33	-194.195	-158.0739	-14.88134	-271.873	-485.95224	-405.98924	-376.22656	-189.65684	-159.89416
357	0	-191.5626	-156.0333	18.74855	-268.18764	-479.5284	-367.15987	-404.65697	-153.65779	-191.15489
358	0.75	-120.2966	-98.30238	15.23753	-168.41524	-301.639728	-227.42077	-257.89583	-93.02941	-123.50447
359	1.5	-51.63426	-42.25892	11.72652	-72.329964	-129.611384	-92.529512	-115.982552	-34.771314	-58.224354
360	2.25	13.11928	10.97203	8.215508	18.366992	33.298384	34.930674	18.499658	20.02286	3.591844
361	3	75.26907	62.51549	4.704495	105.376698	190.347668	157.542869	148.133879	72.446658	63.037668
362	0	75.1846	62.45068	7.034121	105.25844	190.142608	159.70321	145.638079	74.700261	60.632019
363	0.75	80.61186	66.24029	3.123605	112.856604	202.718696	166.098127	159.850917	75.674279	69.427069
364	1.5	83.40537	66.3424	-0.786911	116.767518	209.434284	167.6419329	169.2157551	74.2779219	75.8517441
365	2.25	82.35013	67.63201	-4.697427	115.250182	207.031372	161.754739	171.149593	69.41769	78.812544
366	3	78.66114	65.23412	-8.607943	110.125556	198.76796	151.016345	168.235431	62.187083	79.402969
367	0	78.7077	65.31167	-6.389611	110.455078	199.021196	153.440683	166.220505	64.494782	77.274604
368	0.75	18.36473	15.16997	-8.625647	25.770522	46.309528	28.581999	45.833293	7.90261	25.153904
369	1.5	-44.66505	-36.66522	-10.86136	-62.53107	-112.262412	-101.12466	-79.4019	-51.089925	-29.337165
370	2.25	-111.5436	-91.31291	-13.09712	-150.16104	-279.952976	-233.26235	-212.06811	-113.48636	-67.29212
371	3	-181.0559	-147.6481	-15.33285	-253.47826	-453.50404	-380.24803	-349.58233	-178.28316	-147.61746
372	0	-183.3484	-149.406	18.50094	-256.68776	-459.06768	-350.92314	-387.92502	-146.51262	-183.5115
373	0.75	-109.4907	-89.69716	15.0104	-153.28698	-274.904296	-206.0756	-236.0964	-83.53123	-113.55203
374	1.5	-38.26668	-31.67577	11.51986	-53.573352	-96.601248	-66.075926	-89.115646	-22.920152	-45.959872
375	2.25	29.10854	23.53312	8.029321	40.751950	72.59324	66.432689	50.434047	34.227007	18.168365
376	3	93.05001	77.0545	4.538781	131.390014	235.907212	194.213293	185.135731	89.00379	79.926228
377	0	93.68575	76.92577	6.782953	131.15005	235.504132	196.131623	182.565717	91.100128	77.534222
378	0.75	98.40483	80.13971	3.040903	137.766762	246.309332	201.265409	195.184603	91.60525	85.523444
379	1.5	100.4502	81.66515	-0.701147	140.68623	251.25408	201.553243	202.955537	89.740033	91.142327
380	2.25	98.72573	80.38008	-4.443197	136.217422	247.080204	194.409539	203.295353	84.41086	93.297254
381	3	94.32956	77.40652	-8.185245	132.061584	237.045904	182.416746	198.787238	76.71358	93.08185
382	0	94.49597	77.54094	-6.038357	132.294358	237.460669	184.997747	196.974461	79.019016	91.08473
383	0.75	28.16689	22.75073	-8.060158	39.433646	70.201436	48.49084	64.611156	17.290043	33.410359
384	1.5	-40.79593	-33.72697	-10.08196	-57.114302	-102.918268	-92.764046	-72.600126	-46.798297	-26.634377
385	2.25	-113.6075	-93.01717	-12.10376	-159.0505	-285.156472	-241.44993	-217.24241	-114.35051	-50.14299
386	3	-183.0528	-153.9949	-14.12556	-264.67392	-473.2552	-394.98382	-366.7327	-184.27308	-156.02196
387	0	-185.7927	-151.4538	20.08457	-260.10978	-465.27732	-354.32047	-394.48961	-147.12886	-187.298
388	0.75	-114.5075	-93.76615	16.28647	-160.3105	-287.43484	-214.88868	-247.46162	-86.77028	-119.34322
389	1.5	-45.85612	-37.76603	12.48838	-64.198568	-115.452992	-80.304994	-105.281754	-28.782128	-53.758888

370	2,25	15,94655	15,4213	8,690289	26,525784	47,410432	46,847761	29,457183	25,742193	8,361615
370	3	81,11549	66,92171	4,892196	113,557896	204,413324	169,152494	159,395102	77,896137	68,111745
371	0	81,0095	66,83669	7,246516	113,4733	204,150104	171,294606	156,801574	80,155566	65,662034
371	0,75	86,0155	70,27151	3,307615	120,42184	215,653136	176,798045	170,182415	60,721855	74,106225
371	1,5	88,38796	72,01885	-0,6308899	123,743144	221,295712	177,4535161	178,7152879	78,9162781	80,1800499
371	2,25	86,91157	70,95369	-4,569587	121,676198	217,819788	170,677987	179,817161	73,650826	82,79
371	3	82,80142	68,20102	-8,508287	115,921988	208,463336	159,054437	176,071011	66,012991	83,029565
372	0	82,89233	68,27401	-6,243907	116,049262	208,709212	161,500899	173,968713	68,35919	80,847004
372	0,75	21,39043	17,28959	-9,513008	29,946602	53,33186	33,445098	52,471114	9,736379	28,764395
372	1,5	-42,74522	-35,38232	-12,78211	-59,843308	-107,905976	-99,458694	-73,854474	-51,252806	-25,688588
372	2,25	-110,7296	-90,86674	-16,05121	-155,02144	-278,262304	-239,79347	-207,69105	-115,70785	-83,60543
372	3	-181,3478	-148,0387	-19,32031	-253,66892	-454,47928	-384,97637	-346,33575	-162,53333	-143,89271
373	0	-181,9689	-148,5562	15,16615	-254,75546	-456,0526	-351,75273	-362,06503	-148,60586	-178,93810
373	0,75	-111,209	-91,02017	12,22752	-155,6326	-279,05972	-212,24345	-236,69849	-87,85359	-112,31562
373	1,5	-43,08276	-35,17161	9,288679	-60,315584	-107,973888	-77,582043	-96,159801	-26,455605	-48,063363
373	2,25	21,19469	17,86444	6,350241	29,672586	54,016732	49,646306	36,947827	25,425482	12,72496
373	3	82,83639	69,213	3,411603	115,97376	210,146668	172,030671	166,207465	77,966154	71,142948
374	0	82,7357	69,1365	5,679994	115,52418	209,90454	174,102934	162,742946	83,144324	69,784839
374	0,75	86,82461	72,1576	2,629502	121,554454	219,641592	178,976634	173,71782	83,771651	75,514647
374	1,5	86,27677	73,4912	-0,4209889	123,587478	223,576544	179,0023351	179,843129	79,0281041	79,8700819
374	2,25	85,68018	72,0123	-3,47148	120,232252	218,275596	171,597036	176,539996	73,820682	80,763642
374	3	80,84985	66,6450	-6,521971	113,15979	207,17326	159,343749	172,387691	66,242894	79,286836
375	0	80,95612	68,93533	-4,369356	113,335568	207,443872	161,713318	170,45203	58,431152	77,229864
375	0,75	18,40941	17,45704	-6,538403	25,773174	50,022556	33,009929	46,086735	10,030066	23,106872
375	1,5	-46,77105	-35,70876	-8,707449	-65,47947	-113,259276	-100,541469	-83,126571	-50,601394	-33,386496
375	2,25	-115,9003	-91,68705	-10,8765	-162,12042	-285,05961	-241,58391	-219,77091	-115,09677	-93,34377
375	3	-187,4632	-149,3528	-13,04554	-262,44848	-463,92032	-387,35416	-361,2631	-161,76242	-155,67134
376	0	-190,0437	-150,6695	20,97522	-266,06118	-469,12364	-357,74672	-399,69716	-150,06411	-192,01455
376	0,75	-114,1292	-90,9579	17,63063	-159,79088	-262,48768	-210,26231	-245,54357	-85,06565	-120,34691
376	1,5	-40,84852	-32,93381	14,28605	-57,157528	-101,71232	-67,668994	-96,28084	-22,477515	-51,049718
376	2,25	26,58342	22,27778	10,94147	40,016788	59,642552	67,519351	45,636414	36,665648	14,783608
376	3	95,38162	75,80187	7,595681	133,634268	235,740936	197,856695	182,662933	93,440339	78,246577
377	0	95,32703	75,76102	9,996953	133,457842	235,610068	200,150409	180,156503	95,79126	75,797374
377	0,75	101,1009	77,90855	4,546938	141,54126	245,97476	203,776560	194,682692	95,537748	86,443872
377	1,5	104,2411	78,36857	-0,9030758	145,53754	256,479032	202,5548142	204,3609658	92,9139142	94,7200658
377	2,25	103,5325	76,01609	-6,35309	144,5485	245,664741	193,902	206,50818	86,82616	99,53234
377	3	100,1902	71,97611	-11,8031	140,26628	235,53015	180,40125	204,00745	78,36808	101,97428
378	0	100,3569	72,11134	-9,748261	140,50246	236,60824	162,793759	202,290281	80,574749	100,071271
378	0,75	41,74082	27,69323	-9,987627	58,437148	94,398152	67,74557	87,769841	27,579111	47,554365

Lampiran A6

378	1,5	-19.51096	-18.41238	-10.22699	-27.315344	-52.87296	-52.052522	-31.595542	-27.786554	-7.332874
378	2,25	-84.6115	-67.33049	-10.46636	-118.4561	-209.262584	-179.33065	-158.39793	-86.61671	-65.68399
378	3	-152.3458	-117.9361	-10.70573	-213.28412	-371.51272	-311.45679	-290.04533	-147.81695	-126.40549
379	0	-149.0522	-115.7658	21.79063	-208.67308	-364.08792	-272.83781	-316.41907	-112.35635	-155.93761
379	0,9	-78.18841	-60.12321	10.68483	-109.463774	-190.023218	-143.264472	-164.634132	-59.684739	-81.054399
379	1,8	-11.64208	-7.396598	-0.4209781	-16.298912	-25.8050528	-21.7880721	-20.9461159	-10.8988501	-10.0568939
379	2,7	48.48725	40.47002	-11.52678	67.88215	122.936732	67.12794	110.1815	32.111745	55.165305
379	3,6	104.2991	85.42063	-22.63259	146.01874	261.831928	187.94696	233.21214	71.2366	116.50178
380	0	104.322	85.43935	-22.28083	146.0508	261.88536	168.34492	232.90659	71.60897	116.17063
380	0,9	82.78186	67.02572	-24.95188	115.894604	206.579384	141.412072	191.315832	49.551794	99.455554
380	1,8	56.92427	45.69609	-27.62293	79.693978	141.422868	86.322284	141.628144	23.608913	78.854773
380	2,7	24.64958	19.50645	-30.29398	34.509552	60.789936	18.792086	79.380046	-8.109268	52.478692
380	3,6	-11.94239	-9.599178	-32.96503	-16.719346	-29.6895528	-56.895076	9.034984	-43.713181	22.216879

MOMEN BALOK PORTAL AS A (ANALISIS 3D)

LABEL	STATION	MD (KN.m)	ML (KN.m)	ME (KN.m)	1,4MD (KN.m)	1,2MD+1,6ML (KN.m)	1,2MD+ML+ME (KN.m)	1,2MD+ML - ME (KN.m)	0,9MD+ME (KN.m)	0,9MD-ME (KN.m)
10	0	-19,67348	-7,175958	-80,01933	-27,542872	-35,0897088	-110,803464	49,235196	-97,725462	62,313198
10	1	-3,670913	1,546838	-34,48771	-5,1392782	-1,9301548	-37,3459676	31,6294524	-37,7915317	31,1838883
10	2	1,9254	2,3583	11,04391	2,69556	6,08376	15,71269	-6,37513	12,77677	-9,31105
10	3	-8,03417	-9,180905	56,57553	-11,247838	-24,330452	37,753621	-75,397439	49,344777	-63,806283
10	4	-28,4	-28,63144	102,1071	-39,76	-79,890304	39,39566	-164,81854	76,5471	-127,6671
11	0	61,98586	44,60232	-4,036139	86,780204	105,2323	114,949213	123,021491	51,751135	59,823413
11	1	49,74282	37,39291	9,779236	69,639948	119,52004	106,863532	87,305056	54,547776	34,9893
11	2	23,37535	19,06683	23,59462	32,72549	58,557348	70,71187	23,52263	44,632435	-2,556805
11	3	-18,94396	-11,95124	37,40999	-26,521544	-4,954736	2,725998	-72,093982	20,360426	-54,459554
11	4	-71,66953	-50,60065	51,22537	-100,337342	-112,36533	-85,658716	-108,39654	-13,277207	-115,27947
12	0	-74,91399	-53,42952	-56,05864	-104,879586	-175,33265	-199,384948	-87,267668	-123,481231	-11,363951
12	1	-29,29993	-20,69294	-43,05312	-41,019902	-68,26862	-98,955976	-12,799736	-69,423057	16,683183
12	2	10,45121	8,048962	-30,04761	14,631694	25,4197912	-9,457196	50,638024	-20,841521	39,453699
12	3	41,01719	22,9322	-17,0421	57,424066	112,1148	62,110728	96,194928	19,873371	53,957571
12	4	62,00205	44,61544	-4,03658	85,80267	102,36985	114,98132	123,05448	51,765265	59,838425
13	0	27,92777	23,98962	-38,0517	39,098878	71,896716	19,451244	95,554644	-12,916707	63,186693
13	2	32,18372	23,70027	-15,93587	45,057208	76,540896	46,384364	78,256604	13,029478	44,901218
13	4	23,51228	16,50515	6,17997	32,917192	54,622976	50,899856	36,539916	27,341022	14,981082
13	6	-6,097477	-4,501523	28,29581	-8,5364878	-14,5194092	16,4773146	-40,1143054	22,8080807	-33,7835393
13	8	-61,56429	-43,90472	50,41164	-86,750006	-144,6047	-67,850228	-198,67432	-5,356221	-106,179501
14	0	-130,0112	-100,6323	4,47336	-182,01568	-317,02512	-251,168404	-261,123076	-112,532744	-121,487416
14	2,24	-2,672279	1,05E-02	-0,7982345	-3,7411906	-3,18923488	-3,95405185	-2,39754285	-3,2033056	-1,6067966
14	4,47	57,50236	46,58915	-6,073845	80,503304	143,545472	109,519137	121,665827	45,678279	57,825969
14	6,71	44,89647	34,13518	-11,34944	62,855058	108,492052	76,661504	99,360384	29,057383	51,756263
14	8,94	-35,7921	-33,19667	-16,62503	-50,10894	-90,065192	-92,77222	-59,52216	-48,83792	-15,58786
15	0	4,116557	16,17658	-6,36048	5,7631796	30,8223964	12,7559684	29,4769284	-4,6555767	12,0653813
15	1	11,11781	15,86552	-4,044642	15,564934	38,717244	25,156685	33,245934	5,93387	14,050671
15	2	7,712801	7,631937	0,2711958	10,7979214	21,4664604	17,158494	16,6161024	7,2127167	6,6703251
15	3	-11,24809	-12,94672	4,587034	-15,747326	-34,21246	-21,857594	-31,031462	-5,536247	-14,710315
15	4	-40,61523	-41,4367	8,902872	-56,861322	-115,036996	-81,272104	-91,078322	-27,650835	-45,456579
16	0	49,02426	31,4402	1,848323	66,633964	109,133432	92,117635	88,420969	45,970157	42,273511
16	1	33,93441	22,90356	2,969357	47,508174	77,375628	66,599609	60,660895	33,510326	27,571612
16	2	12,98164	10,38306	4,09039	18,174295	32,190964	30,031418	21,870638	15,773866	7,593086
16	3	-16,76034	-8,660181	5,211423	-23,464476	-33,9686976	-23,561166	-33,994012	-9,872883	-20,255729
16	4	-52,36525	-31,69809	6,332457	-73,31135	-113,555244	-88,203933	-100,868847	-40,796268	-53,461182

Lampiran A7

17	0	-46.37467	-28.65556	-4.977182	-64.924538	-101.562532	-89.322366	-79.368532	-46.714385	-36.760021
17	1	-12.26838	-6.40923	-3.271058	-17.175732	-24.976824	-24.402344	-17.860225	-14.3126	-7.770484
17	2	15.97499	11.88246	-1.564933	22.304986	38.181924	29.487515	32.617351	12.812558	15.942424
17	3	35.42914	23.65661	0.1411909	49.600796	80.365854	66.3129689	66.030587	32.0274169	31.7450351
17	4	49.02037	31.4365	1.847315	68.628518	109.122844	92.108259	88.413629	45.965648	42.271018
18	0	-54.68515	-40.06762	-0.8919659	-76.55921	-129.730372	-106.5817659	-104.7978341	-50.1086009	-48.3246691
18	2,24	38.87132	33.77348	-0.4834201	54.419846	100.683152	79.9356439	80.9024841	34.5007679	35.4676081
18	4,47	65.26347	53.54955	-7.49E-02	91.368858	163.295444	131.7908396	131.9405884	58.66224861	56.81199739
18	6,71	18.87509	14.23343	0.3336714	26.425126	45.519596	37.2772094	35.6098666	17.3212524	16.6539096
18	8,94	-95.59596	-79.84056	0.7422171	-133.834344	-242.460048	-193.8134949	-195.2979251	-85.2941469	-86.7785811
19	0	-18.40654	-8.548223	1.052711	-25.769156	-35.7650048	-29.54336	-31.728752	-15.473175	-17.658597
19	1	-2.921486	1.46955	0.2886969	-4.0900804	-1.1545032	-1.7475363	-2.3249331	-2.3406405	-2.9180343
19	2	2.79022	3.57599	-0.5153172	3.905308	9.069848	6.4089368	7.4395712	1.9958808	3.0265152
19	3	-6.065903	-6.668236	-1.319331	-8.4922642	-17.9482612	-15.2666506	-12.6279585	-6.7706137	-4.1399817
19	4	-24.69538	-24.8238	-2.123345	-34.573532	-69.352536	-56.581601	-52.334911	-24.349187	-20.102497

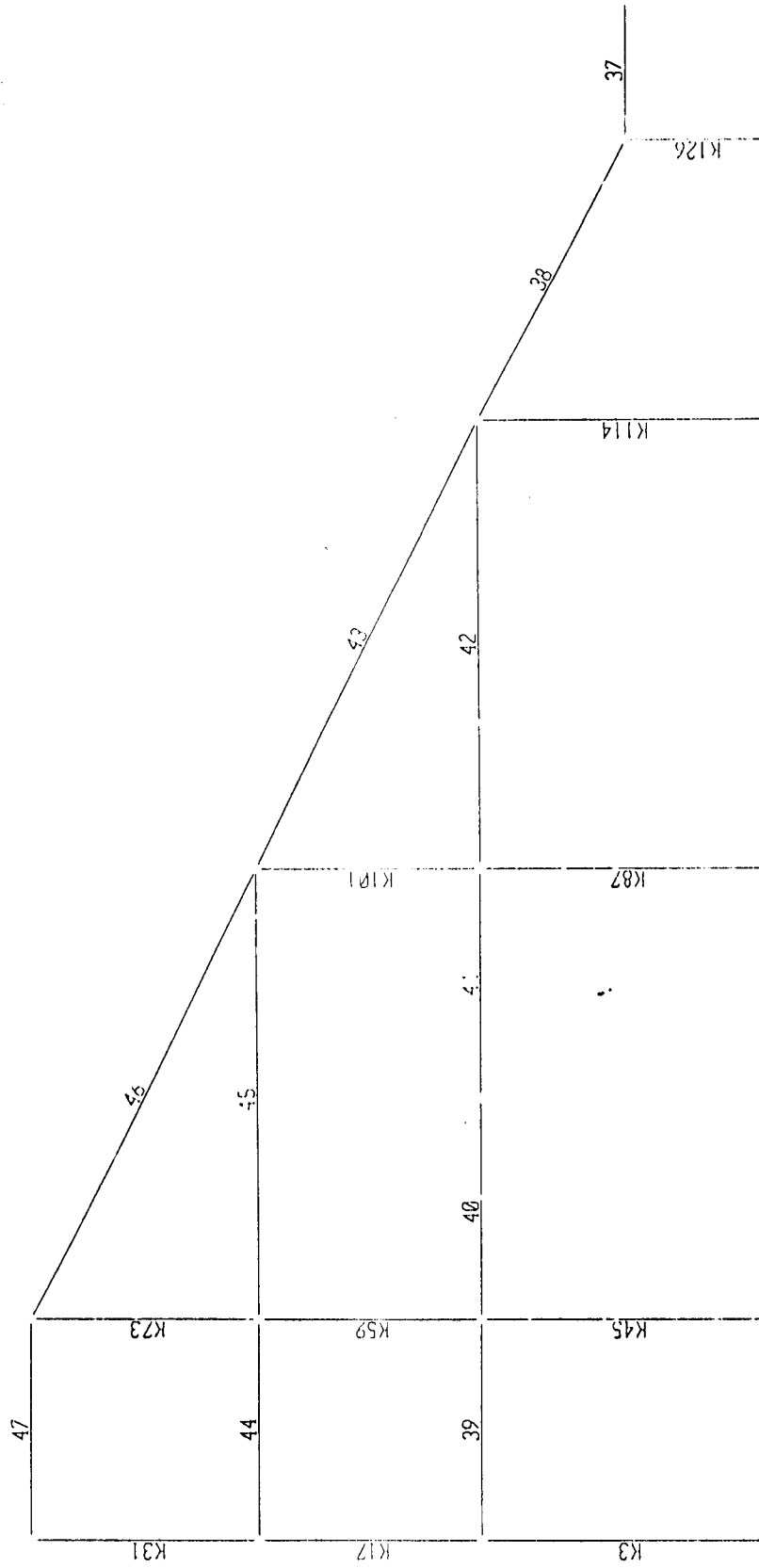

MOMEN BALOK PORTAL AS B (ANALISIS 3D)

LABEL	STATION	MD (KN.m)	ML (KN.m)	ME (KN.m)	1,4MD (KN.m)	1,2MD+1,6ML (KN.m)	1,2MD+ML+ME (KN.m)	1,2MD+ML - ME (KN.m)	0,9MD+ME (KN.m)	0,9MD-ME (KN.m)
37	0	-72,2877	-49,14439	-0,3547396	-101,20278	-165,376248	-136,2443596	-135,5348804	-65,4136636	-64,7041904
37	0,63	-41,37614	-35,05949	-0,2889367	-57,926596	-105,746552	-84,9797947	-84,4419213	-37,5074627	-36,9695893
37	1,25	-24,05404	-23,31836	-0,1831338	-33,675686	-66,174224	-52,3663418	-52,0000742	-21,8317658	-21,4655022
37	1,88	-10,7277	-9,48347	-0,73E-02	-15,018178	-28,046792	-22,45494088	-22,25937912	-9,75226088	-9,55759912
37	2,50	9,15E-03	7,67E-03	-1,15E-02	0,012814764	0,023253226	0,007124338	0,030180258	-0,003289657	0,019766023
38	0	-44,0253	-35,51538	98,54411	-61,63542	-109,654968	10,19837	-186,88985	58,92134	-138,16668
38	1,41	-19,4028	-14,91544	17,57449	-27,16392	-47,148064	-20,62431	-55,77329	0,11197	-35,03701
38	2,83	-16,36266	-11,93767	-63,39513	-22,907724	-38,735464	-94,967992	31,822268	-78,121524	48,668736
38	4,24	-38,79123	-30,18055	-111,3647	-54,307722	-94,838356	-188,094726	34,634674	-145,276807	76,452593
38	5,66	-82,90577	-66,14155	-130,3344	-113,068078	-205,313404	-250,36548	-35,294074	-204,948553	55,719207
39	0	-29,5674	-29,53819	100,4946	-11,39436	-82,741984	35,47553	-135,51432	73,86354	-127,10526
39	1	-9,350059	-10,43823	55,89697	-13,0900826	-27,9212388	34,2386692	-77,5552708	47,4819169	-64,3120231
39	2	0,5515046	0,8283928	-11,29932	0,77210644	1,987234	12,78951832	-9,80912168	11,79567414	-10,80296586
39	3	-4,309375	0,4283481	-33,29834	-6,033125	-4,48589304	-38,0412419	28,5554381	-37,1767775	29,4199025
39	4	-19,48603	-7,80503	-77,89599	-27,280442	-35,871284	-109,084256	46,707724	-95,433417	60,3585553
40	0	-74,18546	-55,48315	51,18797	-103,859644	-177,795592	-93,317732	-195,693672	-15,578544	-117,954384
40	1	-21,06009	-14,83366	36,75114	-29,484126	-49,005964	-3,354628	-76,856908	17,797055	-55,705221
40	2	21,74951	17,9825	-22,31432	30,449314	54,871412	66,396232	21,767592	41,888879	-2,739761
40	3	43,69999	39,04866	7,87494	69,579986	122,117844	106,566142	90,811154	52,607485	36,852497
40	4	64,91803	50,19815	-6,559331	90,885242	158,218676	121,540455	134,659117	51,866696	64,985558
41	0	64,92352	50,20263	-6,55959	90,892928	158,232432	121,551264	134,670444	51,871578	64,990758
41	1	47,84063	37,37954	-18,11141	66,976882	117,71602	76,676886	112,899706	24,945157	61,167977
41	2	16,92531	14,63978	-29,66323	25,235534	45,05402	6,506922	65,933382	-13,440451	45,886009
41	3	-26,64912	-19,84997	-41,21506	-37,308788	-63,738896	-93,043974	-10,613854	-65,199268	17,230852
41	4	-81,63933	-62,17306	-52,76688	-114,295082	-197,444092	-212,907136	-107,373376	-126,242277	-20,708517
42	0	-63,86885	-47,92962	44,34216	-89,41639	-123,330012	-80,23008	-138,9144	-13,139636	-101,824125
42	2	-3,95466	-3,524178	26,34529	-5,536552	-10,3643008	18,075496	-34,615984	22,786378	-29,904502
42	4	25,91305	19,13127	8,348429	38,13827	61,585692	58,455339	41,758501	31,580174	14,983316
42	6	22,82434	17,78671	-9,619436	31,954076	55,847844	35,527482	54,824354	10,89547	30,190342
42	8	-10,31081	-5,307841	-27,6453	-14,435134	-20,8655176	-45,326113	9,964487	-36,925028	18,365571
43	0	-99,94398	-81,15185	-1,221622	-139,921572	-249,775736	-202,306248	-199,863004	-91,171204	-88,72796
43	2,24	3,660888	3,97076	-1,509927	5,1241232	10,7453216	6,8529386	9,8727926	1,7841522	4,8040062
43	4,47	46,72958	39,07043	-1,798232	65,505412	118,660184	93,419694	97,016158	40,31239	43,908854
43	6,71	25,51038	20,50447	2,065537	35,714532	63,419608	49,300389	53,203463	20,872805	25,045879
43	8,94	-56,90611	-48,69804	-2,374842	-79,668554	-146,204196	-119,360214	-114,61053	-53,590341	-48,840657
44	0	-44,50103	-43,58318	10,03655	-62,301442	-123,134324	-86,947866	-107,020966	-30,014377	-50,087477
44	1	-12,4224	-13,89366	5,130542	-17,39136	-31,136736	-23,669998	-33,931082	-6,049618	-16,310702

44	2	9.340464	7.962519	0.2245367	13.0766495	23.9455572	5.3556125	16.9465391	8.6309543	6.1915509
44	3	16.34088	18.15203	-4.681468	22.877232	48.652304	33.079618	42.442554	10.025324	16.38526
44	4	13.02552	20.50822	-9.587473	18.235728	48.443776	26.551371	45.726317	2.135495	21.310441
45	0	-40.77022	-27.87597	7.406793	-57.078308	-93.525816	-59.393441	-84.207027	-29.286405	-44.099391
45	2	9.625391	8.468594	3.620085	13.4755474	25.1002196	23.6391482	16.3989782	12.2829369	5.0427669
45	4	29.87456	23.06315	-0.1666222	41.824384	72.750528	58.7460098	59.0792542	26.7204818	27.0537262
45	6	17.3673	13.65773	-3.95333	24.31422	42.693128	30.54516	36.45182	11.67724	19.5839
45	8	-25.28641	-17.49771	-7.740037	-35.400974	-58.340028	-55.581439	-40.101365	-30.497806	-15.017732
46	0	-47.15617	-36.1125	-2.305924	-66.018638	-114.367404	-95.005828	-90.39398	-44.746477	-40.134629
46	2,4	36.60658	32.32342	-2.069977	51.249212	95.645368	74.181339	78.321293	30.875845	35.015899
46	4,7	59.89475	50.73641	-1.83403	83.85265	153.051956	120.77608	124.44414	52.071245	55.739305
46	6,7	18.77424	15.48376	-1.588083	26.283936	47.303104	36.414765	39.610931	15.298733	18.494899
46	8,94	-83.48357	-70.40543	-1.362136	-116.876998	-212.828572	-171.94785	-169.223578	-76.497349	-73.773077
47	0	-25.62351	-25.03601	-0.9566194	-35.873914	-70.805828	-56.7408414	-54.8276026	-24.0177784	-22.1045396
47	1	-6.020179	-6.60703	-1.023246	-8.4282506	-17.7554528	-14.8544908	-12.8079988	-6.4414071	-4.3949151
47	2	3.894038	3.988618	-1.09872	5.4516532	11.0546374	7.5715916	9.7513356	2.4147622	4.5945062
47	3	-0.0208548	2.917599	-1.156499	-0.02919672	4.6433264	-73607424	4.04907224	-1.17526832	1.13772968
47	4	-13.62486	-5.986753	-1.223123	-19.074804	-25.9255355	-23.55971	-21.11346	-13.485499	-11.039249

AKSIAL BALOK PORTAL AS 1 (ANALISIS 2D)

LABEL	STATION	PD (KN)	PL (KN)	PE (KN)	1,4PD (KN)	1,2PD+1,6PL (KN)	1,2PD+PL+PE (KN)	1,2PD+PL - PE (KN)	0,9PD+PE (KN)	0,9PD-PE (KN)
1	0	16,05444	6,396461	-147,994	22,476216	29,4996656	-122,332211	173,655789	-133,545004	162,442996
1	4,5	16,05444	6,396461	-147,994	22,476216	29,4996656	-122,332211	173,655789	-133,545004	162,442996
1	9	16,05444	6,396461	-147,994	22,476216	29,4996656	-122,332211	173,655789	-133,545004	162,442996
2	0	12,53986	5,719265	-152,9297	17,555804	24,198656	-132,162603	173,696797	-141,643826	164,215574
2	4,5	12,53986	5,719265	-152,9297	17,555804	24,198656	-132,162603	173,696797	-141,643826	164,215574
2	9	12,53986	5,719265	-152,9297	17,555804	24,198656	-132,162603	173,696797	-141,643826	164,215574
3	0	10,95376	5,218584	-139,0288	15,335264	21,4942464	-120,665704	157,391896	-129,170416	148,887184
3	4,5	10,95376	5,218584	-139,0288	15,335264	21,4942464	-120,665704	157,391896	-129,170416	148,887184
3	9	10,95376	5,218584	-139,0288	15,335264	21,4942464	-120,665704	157,391896	-129,170416	148,887184
4	0	9,830087	4,920488	-133,9889	13,7321218	19,6688852	-117,2723076	150,7054924	-125,1418217	142,8359783
4	4,5	9,830087	4,920488	-133,9889	13,7321218	19,6688852	-117,2723076	150,7054924	-125,1418217	142,8359783
4	9	9,830087	4,920488	-133,9889	13,7321218	19,6688852	-117,2723076	150,7054924	-125,1418217	142,8359783
5	0	9,048584	4,705724	-127,5733	12,6680176	18,3674592	-112,0092752	143,1373248	-119,4295744	135,7170256
5	4,5	9,048584	4,705724	-127,5733	12,6680176	18,3674592	-112,0092752	143,1373248	-119,4295744	135,7170256
5	9	9,048584	4,705724	-127,5733	12,6680176	18,3674592	-112,0092752	143,1373248	-119,4295744	135,7170256
6	0	8,667331	4,599869	-97,63024	12,1342634	17,7605876	-82,6295738	112,6309062	-89,8296421	105,4308379
6	4,5	8,667331	4,599869	-97,63024	12,1342634	17,7605876	-82,6295738	112,6309062	-89,8296421	105,4308379
6	9	8,667331	4,599869	-97,63024	12,1342634	17,7605876	-82,6295738	112,6309062	-89,8296421	105,4308379
7	0	14,33389	7,258712	-104,4222	20,067446	28,8146072	-79,96282	128,88158	-91,521699	117,322701
7	4,5	14,33389	7,258712	-104,4222	20,067446	28,8146072	-79,96282	128,88158	-91,521699	117,322701
7	10	14,33389	7,258712	-104,4222	20,067446	28,8146072	-79,96282	128,88158	-91,521699	117,322701
8	0	9,346821	4,84933	-114,0672	13,0855494	18,9751132	-98,0016848	130,1327152	-105,6550611	122,4793389
8	4,5	9,346821	4,84933	-114,0672	13,0855494	18,9751132	-98,0016848	130,1327152	-105,6550611	122,4793389
8	9	9,346821	4,84933	-114,0672	13,0855494	18,9751132	-98,0016848	130,1327152	-105,6550611	122,4793389
9	0	10,23263	5,130991	-91,69708	14,325682	22,4687416	-74,286933	109,107227	-82,487713	100,906447
9	4,5	10,23263	5,130991	-91,69708	14,325682	22,4687416	-74,286933	109,107227	-82,487713	100,906447
9	9	10,23263	5,130991	-91,69708	14,325682	22,4687416	-74,286933	109,107227	-82,487713	100,906447
10	0	11,26818	5,480291	-69,681	15,775452	22,2902816	-50,678893	88,683107	-59,539638	79,822362
10	4,5	11,26818	5,480291	-69,681	15,775452	22,2902816	-50,678893	88,683107	-59,539638	79,822362
10	9	11,26818	5,480291	-69,681	15,775452	22,2902816	-50,678893	88,683107	-59,539638	79,822362
11	0	12,67916	5,915484	-49,01575	17,750824	24,6797664	-27,885274	70,146226	-37,604506	60,426994
11	4,5	12,67916	5,915484	-49,01575	17,750824	24,6797664	-27,885274	70,146226	-37,604506	60,426994
11	9	12,67916	5,915484	-49,01575	17,750824	24,6797664	-27,885274	70,146226	-37,604506	60,426994
12	0	14,43638	6,520085	-29,05937	20,210932	27,755792	-5,215629	52,903111	-16,066628	42,052112
12	4,5	14,43638	6,520085	-29,05937	20,210932	27,755792	-5,215629	52,903111	-16,066628	42,052112

12	9	14,45638	6,52085	-29,0593	20,210932	27,755792	-5,215629	52,903111	-16,566628	-42,052112
13	0	16,98403	7,075417	-10,70035	23,777642	31,7015032	16,755903	38,156603	4,585277	25,985977
13	4,5	16,96403	7,075417	-10,70035	23,777642	31,7015032	16,755903	38,156603	4,585277	25,985977
13	9	16,98403	7,075417	-10,70035	23,777642	31,7015032	16,755903	38,156603	4,585277	25,985977
14	0	-10,61719	2,743042	-325,3256	-14,864066	-8,3517608	-335,324186	335,324332	-334,882071	315,771129
14	4,5	-10,61719	2,743042	-325,3256	-14,864066	-8,3517608	-335,324186	335,324332	-334,882071	315,771129
14	9	-10,61719	2,743042	-325,3256	-14,864066	-8,3517608	-335,324186	335,324332	-334,882071	315,771129
15	0	-8,917817	1,582191	-271,6353	-12,4849438	-8,1698748	-280,7554894	123,2170323	-279,6623353	263,6102647
15	4,5	-8,917817	1,582191	-271,6353	-12,4849438	-8,1698748	-280,7554894	123,2170323	-279,6623353	263,6102647
15	9	-8,917817	1,582191	-271,6353	-12,4849438	-8,1698748	-280,7554894	123,2170323	-279,6623353	263,6102647
16	0	-8,034058	1,521425	-233,6356	-11,2476812	-7,2065896	-241,7500446	120,33232	-240,8612522	226,3999478
16	4,5	-8,034058	1,521425	-233,6356	-11,2476812	-7,2065896	-241,7500446	120,33232	-240,8612522	226,3999478
16	9	-8,034058	1,521425	-233,6356	-11,2476812	-7,2065896	-241,7500446	120,33232	-240,8612522	226,3999478
17	0	-7,530315	1,267881	-197,0633	-10,542441	-7,0077684	-204,836397	189,301403	-203,8471835	190,2926165
17	4,5	-7,530315	1,267881	-197,0633	-10,542441	-7,0077684	-204,836397	189,301403	-203,8471835	190,2926165
17	9	-7,530315	1,267881	-197,0633	-10,542441	-7,0077684	-204,836397	189,301403	-203,8471835	190,2926165
18	0	-7,138886	1,161268	-164,6276	-9,994404	-6,7086344	-172,032952	157,2222048	-171,0525974	158,2026026
18	4,5	-7,138886	1,161268	-164,6276	-9,994404	-6,7086344	-172,032952	157,2222048	-171,0525974	158,2026026
18	9	-7,138886	1,161268	-164,6276	-9,994404	-6,7086344	-172,032952	157,2222048	-171,0525974	158,2026026
19	0	-7,13095	0,8306787	-156,0717	-9,98333	-7,22805408	-163,7981613	148,3452387	-162,489555	149,653845
19	4,5	-7,13095	0,8306787	-156,0717	-9,98333	-7,22805408	-163,7981613	148,3452387	-162,489555	149,653845
19	9	-7,13095	0,8306787	-156,0717	-9,98333	-7,22805408	-163,7981613	148,3452387	-162,489555	149,653845
20	0	-11,86139	-0,6587087	-111,3249	-16,605946	-15,28760192	-126,2172767	280,7553323	-122,000151	100,649649
20	4,5	-11,86139	-0,6587087	-111,3249	-16,605946	-15,28760192	-126,2172767	280,7553323	-122,000151	100,649649
20	9	-11,86139	-0,6587087	-111,3249	-16,605946	-15,28760192	-126,2172767	280,7553323	-122,000151	100,649649
21	0	-7,494553	0,6340755	-66,66974	-10,4923742	-7,9789428	-75,0485281	58,3297519	-73,4342377	59,9440423
21	4,5	-7,494553	0,6340755	-66,66974	-10,4923742	-7,9789428	-75,0485281	58,3297519	-73,4342377	59,9440423
21	9	-7,494553	0,6340755	-66,66974	-10,4923742	-7,9789428	-75,0485281	58,3297519	-73,4342377	59,9440423
22	0	-7,650082	0,9354609	-56,54905	-10,7101148	-7,9336096	-64,7936875	48,3044125	-53,4341238	49,6639762
22	4,5	-7,650082	0,9354609	-56,54905	-10,7101148	-7,9336096	-64,7936875	48,3044125	-53,4341238	49,6639762
22	9	-7,650082	0,9354609	-56,54905	-10,7101148	-7,9336096	-64,7936875	48,3044125	-53,4341238	49,6639762
23	0	-7,99095	1,02781	-45,96739	-11,18733	-7,944644	-54,52872	37,40606	-53,159245	38,775535
23	4,5	-7,99095	1,02781	-45,96739	-11,18733	-7,944644	-54,52872	37,40606	-53,159245	38,775535
23	9	-7,99095	1,02781	-45,96739	-11,18733	-7,944644	-54,52872	37,40606	-53,159245	38,775535
24	0	8,421002	1,284116	-35,56617	-11,7894028	-8,0506168	-44,3872564	26,7450836	-43,1450718	27,9872682
24	4,5	8,421002	1,284116	-35,56617	-11,7894028	-8,0506168	-44,3872564	26,7450836	-43,1450718	27,9872682
24	9	8,421002	1,284116	-35,56617	-11,7894028	-8,0506168	-44,3872564	26,7450836	-43,1450718	27,9872682
25	0	-9,020598	1,425874	-24,34438	-12,6288372	-8,5433192	-33,7432236	14,9455364	-32,4629182	16,2258418
25	4,5	-9,020598	1,425874	-24,34438	-12,6288372	-8,5433192	-33,7432236	14,9455364	-32,4629182	16,2258418

25	9	-9,020598	1,425874	-24,34438	-12,6286372	-8,5433192	-33,7432236	14,9455364	-32,4522152	16,2258418
26	0	-9,827668	2,538255	-12,26944	-13,7587352	-7,7319936	-21,5243866	3,0144934	-21,1143412	3,4245388
26	4,5	-9,827668	2,538255	-12,26944	-13,7587352	-7,7319936	-21,5243866	3,0144934	-21,1143412	3,4245388
26	9	-9,827668	2,538255	-12,26944	-13,7587352	-7,7319936	-21,5243866	3,0144934	-21,1143412	3,4245388
27	0	-20,27116	-16,20575	-358,1062	-28,379652	-50,254616	-398,637366	317,575034	-376,350262	339,862138
27	4,5	-20,27116	-16,20575	-358,1062	-28,379652	-50,254616	-398,637366	317,575034	-376,350262	339,862138
27	9	-20,27116	-16,20575	-358,1062	-28,379652	-50,254616	-398,637366	317,575034	-376,350262	339,862138
28	0	-10,95954	-14,49324	-323,5997	-26,543356	-45,940632	-360,844388	286,355012	-340,663286	306,536114
28	4,5	-18,95954	-14,49324	-323,5997	-26,543356	-45,940632	-360,844388	286,355012	-340,663286	306,536114
28	9	-18,95954	-14,49324	-323,5997	-26,543356	-45,940632	-360,844388	286,355012	-340,663286	306,536114
29	0	-18,92763	-14,24838	-295,3287	-26,496682	-44,729716	-302,264824	229,468976	-282,750603	248,983197
29	4,5	-18,92763	-14,24838	-295,3287	-26,496682	-44,729716	-302,264824	229,468976	-282,750603	248,983197
29	9	-18,92763	-14,24838	-295,3287	-26,496682	-44,729716	-302,264824	229,468976	-282,750603	248,983197
30	0	-18,75967	-13,88632	-265,8669	-26,263538	-44,309132	-273,277362	201,087038	-253,986109	220,378291
30	4,5	-18,75967	-13,88632	-265,8669	-26,263538	-44,309132	-273,277362	201,087038	-253,986109	220,378291
30	9	-18,75967	-13,88632	-265,8669	-26,263538	-44,309132	-273,277362	201,087038	-253,986109	220,378291
31	0	-18,67101	-13,68995	-237,1822	-26,135414	-44,309132	-273,277362	201,087038	-253,986109	220,378291
31	4,5	-18,67101	-13,68995	-237,1822	-26,135414	-44,309132	-273,277362	201,087038	-253,986109	220,378291
31	9	-18,67101	-13,68995	-237,1822	-26,135414	-44,309132	-273,277362	201,087038	-253,986109	220,378291
32	0	-18,20938	-13,19059	-206,412	-25,493132	-42,9562	-241,453846	171,370154	-222,800442	190,023558
32	4,5	-18,20938	-13,19059	-206,412	-25,493132	-42,9562	-241,453846	171,370154	-222,800442	190,023558
32	9	-18,20938	-13,19059	-206,412	-25,493132	-42,9562	-241,453846	171,370154	-222,800442	190,023558
33	0	-20,99184	-15,31205	-180,4556	-29,388576	-49,689488	-220,957858	139,953342	-199,348256	161,562944
33	5	-20,99184	-15,31205	-180,4556	-29,388576	-49,689488	-220,957858	139,953342	-199,348256	161,562944
33	10	-20,99184	-15,31205	-180,4556	-29,388576	-49,689488	-220,957858	139,953342	-199,348256	161,562944
34	0	-18,19196	-13,07664	-155,1295	-25,468744	-42,752976	-190,036492	120,222508	-171,502264	138,756736
34	4,5	-18,19196	-13,07664	-155,1295	-25,468744	-42,752976	-190,036492	120,222508	-171,502264	138,756736
34	9	-18,19196	-13,07664	-155,1295	-25,468744	-42,752976	-190,036492	120,222508	-171,502264	138,756736
35	0	-18,77667	-13,59996	-127,5994	-26,290138	-44,25434	-163,733764	91,465036	-144,500203	110,698597
35	4,5	-18,77667	-13,59996	-127,5994	-26,290138	-44,25434	-163,733764	91,465036	-144,500203	110,698597
35	9	-18,77667	-13,59996	-127,5994	-26,290138	-44,25434	-163,733764	91,465036	-144,500203	110,698597
36	0	-18,98092	-13,80815	-101,2279	-26,573288	-44,870144	-137,813154	64,642646	-118,310728	84,145072
36	4,5	-18,98092	-13,80815	-101,2279	-26,573288	-44,870144	-137,813154	64,642646	-118,310728	84,145072
36	9	-18,98092	-13,80815	-101,2279	-26,573288	-44,870144	-137,813154	64,642646	-118,310728	84,145072
37	0	-19,33472	-14,21651	-74,16815	-27,068608	-45,94808	-111,586324	36,749976	-91,569398	56,766902
37	4,5	-19,33472	-14,21651	-74,16815	-27,068608	-45,94808	-111,586324	36,749976	-91,569398	56,766902
37	9	-19,33472	-14,21651	-74,16815	-27,068608	-45,94808	-111,586324	36,749976	-91,569398	56,766902
38	0	-19,60242	-14,55391	-47,95002	-27,443386	-46,80916	-86,026844	9,873216	-65,592208	30,307852
38	4,5	-19,60242	-14,55391	-47,95002	-27,443386	-46,80916	-86,026844	9,873216	-65,592208	30,307852

Lampiran A9

38	9	-19,60242	-14,55391	-47,95003	-27,445339	-46,80916	-86,026844	9,873216	-65,592206	30 30/7852
39	0	-21,07039	-16,1648	-19,71696	-29,498546	-51,148148	-61,166228	-21,732308	-38,680311	0 753609
39	4,5	-21,07039	-16,1648	-19,71696	-29,498546	-51,148148	-61,166228	-21,732308	-38,680311	0 753609
39	9	-21,07039	-16,1648	-19,71696	-29,498546	-51,148148	-61,166228	-21,732308	-38,680311	0 753609



AKSIAL BALOK PORTAL AS 2 (ANALISIS 2D)

LABEL	STATION	PD (KN)	PL (KN)	PE (KN)	1,4PD (KN)	1,2PD+1,6PL (KN)	1,2PD+PL+PE (KN)	1,2PD+PL - PE (KN)	0,9PD+PE (KN)	0,9PD-FE (KN)
1	0	11,23958	11,17563	-196,2428	15,735412	31,368504	-171,579674	220,905926	-186,127178	206,358422
1	1,8	11,23958	11,17563	-196,2428	15,735412	31,368504	-171,579674	220,905926	-186,127178	206,358422
1	3,6	11,23958	11,17563	-196,2428	15,735412	31,368504	-171,579674	220,905926	-186,127178	206,358422
1	5,4	11,23958	11,17563	-196,2428	15,735412	31,368504	-171,579674	220,905926	-186,127178	206,358422
1	7,2	11,23958	11,17563	-196,2428	15,735412	31,368504	-171,579674	220,905926	-186,127178	206,358422
2	0	7,956331	7,506886	-177,1342	11,1388634	21,5586148	-160,0797168	194,1886832	-169,9735021	184,2948979
2	2,25	7,956331	7,506886	-177,1342	11,1388634	21,5586148	-160,0797168	194,1886832	-169,9735021	184,2948979
2	4,5	7,956331	7,506886	-177,1342	11,1388634	21,5586148	-160,0797168	194,1886832	-169,9735021	184,2948979
2	6,75	7,956331	7,506886	-177,1342	11,1388634	21,5586148	-160,0797168	194,1886832	-169,9735021	184,2948979
2	9	7,956331	7,506886	-177,1342	11,1388634	21,5586148	-160,0797168	194,1886832	-169,9735021	184,2948979
3	0	4,254908	4,008518	-157,5012	5,9568712	11,5195184	-148,3867924	166,6156076	-153,6717828	161,3306172
3	2,25	4,254908	4,008518	-157,5012	5,9568712	11,5195184	-148,3867924	166,6156076	-153,6717828	161,3306172
3	4,5	4,254908	4,008518	-157,5012	5,9568712	11,5195184	-148,3867924	166,6156076	-153,6717828	161,3306172
3	6,75	4,254908	4,008518	-157,5012	5,9568712	11,5195184	-148,3867924	166,6156076	-153,6717828	161,3306172
3	9	4,254908	4,008518	-157,5012	5,9568712	11,5195184	-148,3867924	166,6156076	-153,6717828	161,3306172
4	0	1,925445	2,178346	-139,3206	2,695623	5,7958876	-134,83172	143,80948	-137,5876995	141,0535005
4	2,25	1,925445	2,178346	-139,3206	2,695623	5,7958876	-134,83172	143,80948	-137,5876995	141,0535005
4	4,5	1,925445	2,178346	-139,3206	2,695623	5,7958876	-134,83172	143,80948	-137,5876995	141,0535005
4	6,75	1,925445	2,178346	-139,3206	2,695623	5,7958876	-134,83172	143,80948	-137,5876995	141,0535005
4	9	1,925445	2,178346	-139,3206	2,695623	5,7958876	-134,83172	143,80948	-137,5876995	141,0535005
5	0	8,57041	6,14455	-122,3497	11,998574	20,115772	-105,920658	138,778742	-114,636331	130,063069
5	2,25	8,57041	6,14455	-122,3497	11,998574	20,115772	-105,920658	138,778742	-114,636331	130,063069
5	4,5	8,57041	6,14455	-122,3497	11,998574	20,115772	-105,920658	138,778742	-114,636331	130,063069
5	6,75	8,57041	6,14455	-122,3497	11,998574	20,115772	-105,920658	138,778742	-114,636331	130,063069
5	9	8,57041	6,14455	-122,3497	11,998574	20,115772	-105,920658	138,778742	-114,636331	130,063069
6	0	3,800094	4,608372	-106,5152	5,3201316	11,533508	-97,3467152	115,6836848	-103,0951154	109,9352846
6	2,25	3,800094	4,608372	-106,5152	5,3201316	11,533508	-97,3467152	115,6836848	-103,0951154	109,9352846
6	4,5	3,800094	4,608372	-106,5152	5,3201316	11,533508	-97,3467152	115,6836848	-103,0951154	109,9352846
6	6,75	3,800094	4,608372	-106,5152	5,3201316	11,533508	-97,3467152	115,6836848	-103,0951154	109,9352846
6	9	3,800094	4,608372	-106,5152	5,3201316	11,533508	-97,3467152	115,6836848	-103,0951154	109,9352846
7	0	8,046699	7,938169	-91,15891	11,2653786	22,3571092	-73,5647022	108,7531178	-83,9168809	98,4009391
7	2,5	8,046699	7,938169	-91,15891	11,2653786	22,3571092	-73,5647022	108,7531178	-83,9168809	98,4009391
7	5	8,046699	7,938169	-91,15891	11,2653786	22,3571092	-73,5647022	108,7531178	-83,9168809	98,4009391
7	7,5	8,046699	7,938169	-91,15891	11,2653786	22,3571092	-73,5647022	108,7531178	-83,9168809	98,4009391
7	10	8,046699	7,938169	-91,15891	11,2653786	22,3571092	-73,5647022	108,7531178	-83,9168809	98,4009391

Lampiran A10

5	0	4,51579	4,608372	-76,74014	6,322106	12,7923432	-66,71282	86,76746	-72,675929	50,804351
6	2,25	4,51579	4,608372	-76,74014	6,322106	12,7923432	-66,71282	86,76746	-72,675929	50,804351
6	4,5	4,51579	4,608372	-76,74014	6,322106	12,7923432	-66,71282	86,76746	-72,675929	50,804351
8	6,75	4,51579	4,608372	-76,74014	6,322106	12,7923432	-66,71282	86,76746	-72,675929	50,804351
8	9	4,51579	4,608372	-76,74014	6,322106	12,7923432	-66,71282	86,76746	-72,675929	50,804351
9	0	9,055567	6,14455	-63,50357	12,677938	20,6979604	-46,4923396	80,5148004	-55,3535597	71,6535803
9	2,25	9,055567	6,14455	-63,50357	12,677938	20,6979604	-46,4923396	80,5146004	-55,3535597	71,6535803
9	4,5	9,055567	6,14455	-63,50357	12,677938	20,6979604	-46,4923396	80,5148004	-55,3535597	71,6535803
9	6,75	9,055567	6,14455	-63,50357	12,677938	20,6979604	-46,4923396	80,5148004	-55,3535597	71,6535803
9	9	9,055567	6,14455	-63,50357	12,677938	20,6979604	-46,4923396	80,5146004	-55,3535597	71,6535803
10	0	2,29415	2,178346	-50,83762	3,21181	6,2383336	-45,906294	55,768946	-48,772885	52,902355
10	2,25	2,29415	2,178346	-50,83762	3,21181	6,2383336	-45,906294	55,768946	-48,772885	52,902355
10	4,5	2,29415	2,178346	-50,83762	3,21181	6,2383336	-45,906294	55,768946	-48,772885	52,902355
10	6,75	2,29415	2,178346	-50,83762	3,21181	6,2383336	-45,906294	55,768946	-48,772885	52,902355
10	9	2,29415	2,178346	-50,83762	3,21181	6,2383336	-45,906294	55,768946	-48,772885	52,902355
11	0	4,511415	4,008518	-38,70958	6,315981	11,8273268	-29,286864	48,131296	-34,6488065	-2,7693535
11	2,25	4,511415	4,008518	-38,70958	6,315981	11,8273268	-29,286864	48,131296	-34,6488065	-2,7693535
11	4,5	4,511415	4,008518	-38,70958	6,315981	11,8273268	-29,286864	48,131296	-34,6488065	-2,7693535
11	6,75	4,511415	4,008518	-38,70958	6,315981	11,8273268	-29,286864	48,131296	-34,6488065	-2,7693535
11	9	4,511415	4,008518	-38,70958	6,315981	11,8273268	-29,286864	48,131296	-34,6488065	-2,7693535
12	0	8,117003	7,506886	-26,95425	11,3638042	21,7514212	-9,7069604	44,2015396	-19,6489473	34,2595527
12	2,25	8,117003	7,506886	-26,95425	11,3638042	21,7514212	-9,7069604	44,2015396	-19,6489473	34,2595527
12	4,5	8,117003	7,506886	-26,95425	11,3638042	21,7514212	-9,7069604	44,2015396	-19,6489473	34,2595527
12	6,75	8,117003	7,506886	-26,95425	11,3638042	21,7514212	-9,7069604	44,2015396	-19,6489473	34,2595527
12	9	8,117003	7,506886	-26,95425	11,3638042	21,7514212	-9,7069604	44,2015396	-19,6489473	34,2595527
13	0	11,30786	11,17563	-17,23426	15,831064	31,45044	7,510802	41,979322	-7,057186	27,411334
13	1,8	11,30786	11,17563	-17,23426	15,831064	31,45044	7,510802	41,979322	-7,057186	27,411334
13	3,6	11,30786	11,17563	-17,23426	15,831064	31,45044	7,510802	41,979322	-7,057186	27,411334
13	5,4	11,30786	11,17563	-17,23426	15,831064	31,45044	7,510802	41,979322	-7,057186	27,411334
13	7,2	11,30786	11,17563	-17,23426	15,831064	31,45044	7,510802	41,979322	-7,057186	27,411334
14	0	-4,601571	-4,623982	-273,6309	-6,4421954	-12,9202564	-283,7767672	263,4850328	-277,7723139	269,4894861
14	1,8	-4,601571	-4,623982	-273,6309	-6,4421954	-12,9202564	-283,7767672	263,4850328	-277,7723139	269,4894861
14	3,6	-4,601571	-4,623982	-273,6309	-6,4421954	-12,9202564	-283,7767672	263,4850328	-277,7723139	269,4894861
14	5,4	-4,601571	-4,623982	-273,6309	-6,4421954	-12,9202564	-283,7767672	263,4850328	-277,7723139	269,4894861
14	7,2	-4,601571	-4,623982	-273,6309	-6,4421954	-12,9202564	-283,7767672	263,4850328	-277,7723139	269,4894861
15	0	-1,691446	-1,560476	-240,2174	-2,3680244	-4,5264968	-243,8076112	236,6271888	-241,7397014	238,6950986
15	2,25	-1,691446	-1,560476	-240,2174	-2,3680244	-4,5264968	-243,8076112	236,6271888	-241,7397014	238,6950986
15	4,5	-1,691446	-1,560476	-240,2174	-2,3680244	-4,5264968	-243,8076112	236,6271888	-241,7397014	238,6950986
15	6,75	-1,691446	-1,560476	-240,2174	-2,3680244	-4,5264968	-243,8076112	236,6271888	-241,7397014	238,6950986

Lampiran A10

15	9	-1.557446	-1.560476	-240,2174	-2,3680244	-4,5264968	-243,8076112	276,6271888	-241,7397014	236,6950986
16	0	-6,245363	-6,151646	-213,366	-8,7435082	-17,3370692	-227,0120816	199,7199184	-218,9868267	207,7451733
16	2,25	-6,245363	-6,151646	-213,366	-8,7435082	-17,3370692	-227,0120816	199,7199184	-218,9868267	207,7451733
16	4,5	-6,245363	-6,151646	-213,366	-8,7435082	-17,3370692	-227,0120816	199,7199184	-218,9868267	207,7451733
16	6,75	-6,245363	-6,151646	-213,366	-8,7435082	-17,3370692	-227,0120816	199,7199184	-218,9868267	207,7451733
16	9	-6,245363	-6,151646	-213,366	-8,7435082	-17,3370692	-227,0120816	199,7199184	-218,9868267	207,7451733
17	0	-5,12548	-5,058546	-188,2549	-7,175672	-14,2442496	-199,464022	177,045778	-192,867832	183,641968
17	2,25	-5,12548	-5,058546	-188,2549	-7,175672	-14,2442496	-199,464022	177,045778	-192,867832	183,641968
17	4,5	-5,12548	-5,058546	-188,2549	-7,175672	-14,2442496	-199,464022	177,045778	-192,867832	183,641968
17	6,75	-5,12548	-5,058546	-188,2549	-7,175672	-14,2442496	-199,464022	177,045778	-192,867832	183,641968
17	9	-5,12548	-5,058546	-188,2549	-7,175672	-14,2442496	-199,464022	177,045778	-192,867832	183,641968
18	0	-4,945813	-4,838701	-165,1014	-6,9283382	-13,6804972	-175,8786766	154,3241234	-169,5553317	160,6474683
18	2,25	-4,945813	-4,838701	-165,1014	-6,9283382	-13,6804972	-175,8786766	154,3241234	-169,5553317	160,6474683
18	4,5	-4,945813	-4,838701	-165,1014	-6,9283382	-13,6804972	-175,8786766	154,3241234	-169,5553317	160,6474683
18	6,75	-4,945813	-4,838701	-165,1014	-6,9283382	-13,6804972	-175,8786766	154,3241234	-169,5553317	160,6474683
18	9	-4,945813	-4,838701	-165,1014	-6,9283382	-13,6804972	-175,8786766	154,3241234	-169,5553317	160,6474683
19	0	-4,272305	-4,085442	-143,2998	-5,981227	-11,6634732	-152,512008	134,087592	-147,1448745	139,4547255
19	2,25	-4,272305	-4,085442	-143,2998	-5,981227	-11,6634732	-152,512008	134,087592	-147,1448745	139,4547255
19	4,5	-4,272305	-4,085442	-143,2998	-5,981227	-11,6634732	-152,512008	134,087592	-147,1448745	139,4547255
19	6,75	-4,272305	-4,085442	-143,2998	-5,981227	-11,6634732	-152,512008	134,087592	-147,1448745	139,4547255
19	9	-4,272305	-4,085442	-143,2998	-5,981227	-11,6634732	-152,512008	134,087592	-147,1448745	139,4547255
20	0	-6,562772	-6,831616	-123,2118	-9,1878808	-18,805912	-137,9187424	108,5048576	-129,1182948	117,3053052
20	2,5	-6,562772	-6,831616	-123,2118	-9,1878808	-18,805912	-137,9187424	108,5048576	-129,1182948	117,3053052
20	5	-6,562772	-6,831616	-123,2118	-9,1878808	-18,805912	-137,9187424	108,5048576	-129,1182948	117,3053052
20	7,5	-6,562772	-6,831616	-123,2118	-9,1878808	-18,805912	-137,9187424	108,5048576	-129,1182948	117,3053052
20	10	-6,562772	-6,831616	-123,2118	-9,1878808	-18,805912	-137,9187424	108,5048576	-129,1182948	117,3053052
21	0	-4,307928	-4,085442	-104,1297	-6,0310992	-11,7062208	-113,3846556	94,8747444	-106,0068352	100,2525648
21	2,25	-4,307928	-4,085442	-104,1297	-6,0310992	-11,7062208	-113,3846556	94,8747444	-106,0068352	100,2525648
21	4,5	-4,307928	-4,085442	-104,1297	-6,0310992	-11,7062208	-113,3846556	94,8747444	-106,0068352	100,2525648
21	6,75	-4,307928	-4,085442	-104,1297	-6,0310992	-11,7062208	-113,3846556	94,8747444	-106,0068352	100,2525648
21	9	-4,307928	-4,085442	-104,1297	-6,0310992	-11,7062208	-113,3846556	94,8747444	-106,0068352	100,2525648
22	0	-4,935582	-4,838701	-85,26909	-6,9098148	-13,66462	-96,0304894	74,5076906	-69,7111138	80,8270662
22	2,25	-4,935582	-4,838701	-85,26909	-6,9098148	-13,66462	-96,0304894	74,5076906	-69,7111138	80,8270662
22	4,5	-4,935582	-4,838701	-85,26909	-6,9098148	-13,66462	-96,0304894	74,5076906	-69,7111138	80,8270662
22	6,75	-4,935582	-4,838701	-85,26909	-6,9098148	-13,66462	-96,0304894	74,5076906	-69,7111138	80,8270662
22	9	-4,935582	-4,838701	-85,26909	-6,9098148	-13,66462	-96,0304894	74,5076906	-69,7111138	80,8270662
23	0	-5,124557	-5,058546	-67,07665	-7,1743798	-14,243142	-78,2846644	55,8686356	-71,6887513	62,4645487
23	2,25	-5,124557	-5,058546	-67,07665	-7,1743798	-14,243142	-78,2846644	55,8686356	-71,6887513	62,4645487
23	4,5	-5,124557	-5,058546	-67,07665	-7,1743798	-14,243142	-78,2846644	55,8686356	-71,6887513	62,4645487

23	6,75	-5,124557	-5,055546	-67,07665	-7,1743798	-14,243142	-78,2846644	55,8696356	-71,6887513	52,4645457
23	9	-5,124557	-5,055546	-67,07665	-7,1743798	-14,243142	-78,2846644	55,8696356	-71,6887513	62,4645457
24	0	-6,243552	-6,151646	-49,2112	-8,7409728	-17,334896	-62,8551084	35,5672916	-54,8303968	43,5920032
24	2,25	-6,243552	-6,151646	-49,2112	-8,7409728	-17,334896	-62,8551084	35,5672916	-54,8303968	43,5920032
24	4,5	-6,243552	-6,151646	-49,2112	-8,7409728	-17,334896	-62,8551084	35,5672916	-54,8303968	43,5920032
24	6,75	-6,243552	-6,151646	-49,2112	-8,7409728	-17,334896	-62,8551084	35,5672916	-54,8303968	43,5920032
24	9	-6,243552	-6,151646	-49,2112	-8,7409728	-17,334896	-62,8551084	35,5672916	-54,8303968	43,5920032
25	0	-1,69152	-1,560476	-31,99203	-2,368128	-4,5265856	-35,58233	28,40173	-33,514398	30,469662
25	2,25	-1,69152	-1,560476	-31,99203	-2,368128	-4,5265856	-35,58233	28,40173	-33,514398	30,469662
25	4,5	-1,69152	-1,560476	-31,99203	-2,368128	-4,5265856	-35,58233	28,40173	-33,514398	30,469662
25	6,75	-1,69152	-1,560476	-31,99203	-2,368128	-4,5265856	-35,58233	28,40173	-33,514398	30,469662
25	9	-1,69152	-1,560476	-31,99203	-2,368128	-4,5265856	-35,58233	28,40173	-33,514398	30,469662
26	0	-4,603196	-4,623982	-12,59442	-6,4444744	-12,9222064	-22,7422372	2,4466028	-16,7372964	8,4515436
26	1,8	-4,603196	-4,623982	-12,59442	-6,4444744	-12,9222064	-22,7422372	2,4466028	-16,7372964	8,4515436
26	3,6	-4,603196	-4,623982	-12,59442	-6,4444744	-12,9222064	-22,7422372	2,4466028	-16,7372964	8,4515436
26	5,4	-4,603196	-4,623982	-12,59442	-6,4444744	-12,9222064	-22,7422372	2,4466028	-16,7372964	8,4515436
26	7,2	-4,603196	-4,623982	-12,59442	-6,4444744	-12,9222064	-22,7422372	2,4466028	-16,7372964	8,4515436
27	0	-14,54284	-14,2182	-221,6493	-20,359976	-40,200528	-253,318908	189,979692	-234,737856	208,560744
27	1,8	-14,54284	-14,2182	-221,6493	-20,359976	-40,200528	-253,318908	189,979692	-234,737856	208,560744
27	3,6	-14,54284	-14,2182	-221,6493	-20,359976	-40,200528	-253,318908	189,979692	-234,737856	208,560744
27	5,4	-14,54284	-14,2182	-221,6493	-20,359976	-40,200528	-253,318908	189,979692	-234,737856	208,560744
27	7,2	-14,54284	-14,2182	-221,6493	-20,359976	-40,200528	-253,318908	189,979692	-234,737856	208,560744
28	0	-15,3927	-14,61625	-206,4729	-21,54978	-41,85724	-239,56039	173,38541	-220,32633	192,61947
28	2,25	-15,3927	-14,61625	-206,4729	-21,54978	-41,85724	-239,56039	173,38541	-220,32633	192,61947
28	4,5	-15,3927	-14,61625	-206,4729	-21,54978	-41,85724	-239,56039	173,38541	-220,32633	192,61947
28	6,75	-15,3927	-14,61625	-206,4729	-21,54978	-41,85724	-239,56039	173,38541	-220,32633	192,61947
28	9	-15,3927	-14,61625	-206,4729	-21,54978	-41,85724	-239,56039	173,38541	-220,32633	192,61947
29	0	-10,78916	-10,20971	-190,6338	-15,104824	-29,282528	-213,790502	167,477098	-200,344044	180,923556
29	2,25	-10,78916	-10,20971	-190,6338	-15,104824	-29,282528	-213,790502	167,477098	-200,344044	180,923556
29	4,5	-10,78916	-10,20971	-190,6338	-15,104824	-29,282528	-213,790502	167,477098	-200,344044	180,923556
29	6,75	-10,78916	-10,20971	-190,6338	-15,104824	-29,282528	-213,790502	167,477098	-200,344044	180,923556
29	9	-10,78916	-10,20971	-190,6338	-15,104824	-29,282528	-213,790502	167,477098	-200,344044	180,923556
30	0	-9,758893	-9,515602	-174,0936	-13,6624502	-26,9356348	-195,3198736	152,8673264	-182,8766037	165,3105963
30	2,25	-9,758893	-9,515602	-174,0936	-13,6624502	-26,9356348	-195,3198736	152,8673264	-182,8766037	165,3105963
30	4,5	-9,758893	-9,515602	-174,0936	-13,6624502	-26,9356348	-195,3198736	152,8673264	-182,8766037	165,3105963
30	6,75	-9,758893	-9,515602	-174,0936	-13,6624502	-26,9356348	-195,3198736	152,8673264	-182,8766037	165,3105963
30	9	-9,758893	-9,515602	-174,0936	-13,6624502	-26,9356348	-195,3198736	152,8673264	-182,8766037	165,3105963
31	0	-16,76187	-14,01591	-156,883	-23,466618	-42,5397	-191,013154	122,752846	-171,968683	141,797317
31	2,25	-16,76187	-14,01591	-156,883	-23,466618	-42,5397	-191,013154	122,752846	-171,968683	141,797317

Lampiran A10

31	4.5	-16,76187	-14,01591	-156,863	-23,466618	-42,5397	-191,013154	122,752846	-171,966683	141,797317
31	6.75	-16,76187	-14,01591	-156,863	-23,466618	-42,5397	-191,013154	122,752846	-171,966683	141,797317
31	9	-16,76187	-14,01591	-156,863	-23,466618	-42,5397	-191,013154	122,752846	-171,966683	141,797317
32	0	-12,92177	-13,27943	-139,2833	-18,090478	-36,753212	-168,068854	110,497746	-150,912893	127,653707
32	2.25	-12,92177	-13,27943	-139,2833	-18,090478	-36,753212	-168,068854	110,497746	-150,912893	127,653707
32	4.5	-12,92177	-13,27943	-139,2833	-18,090478	-36,753212	-168,068854	110,497746	-150,912893	127,653707
32	6.75	-12,92177	-13,27943	-139,2833	-18,090478	-36,753212	-168,068854	110,497746	-150,912893	127,653707
32	9	-12,92177	-13,27943	-139,2833	-18,090478	-36,753212	-168,068854	110,497746	-150,912893	127,653707
33	0	-17,3596	-16,45749	-121,7916	-24,30344	-47,163504	-159,08061	84,50259	-137,41524	106,16796
33	2.5	-17,3596	-16,45749	-121,7916	-24,30344	-47,163504	-159,08061	84,50259	-137,41524	106,16796
33	5	-17,3596	-16,45749	-121,7916	-24,30344	-47,163504	-159,08061	84,50259	-137,41524	106,16796
33	7.5	-17,3596	-16,45749	-121,7916	-24,30344	-47,163504	-159,08061	84,50259	-137,41524	106,16796
33	10	-17,3596	-16,45749	-121,7916	-24,30344	-47,163504	-159,08061	84,50259	-137,41524	106,16796
34	0	-13,56967	-13,27943	-104,1232	-18,997538	-37,530692	-133,686234	74,560166	-116,335903	91,910497
34	2.25	-13,56967	-13,27943	-104,1232	-18,997538	-37,530692	-133,686234	74,560166	-116,335903	91,910497
34	4.5	-13,56967	-13,27943	-104,1232	-18,997538	-37,530692	-133,686234	74,560166	-116,335903	91,910497
34	6.75	-13,56967	-13,27943	-104,1232	-18,997538	-37,530692	-133,686234	74,560166	-116,335903	91,910497
34	9	-13,56967	-13,27943	-104,1232	-18,997538	-37,530692	-133,686234	74,560166	-116,335903	91,910497
35	0	-17,28174	-14,01591	-85,99887	-24,194436	-43,163544	-120,752868	51,244872	-101,552436	70,445304
35	2.25	-17,28174	-14,01591	-85,99887	-24,194436	-43,163544	-120,752868	51,244872	-101,552436	70,445304
35	4.5	-17,28174	-14,01591	-85,99887	-24,194436	-43,163544	-120,752868	51,244872	-101,552436	70,445304
35	6.75	-17,28174	-14,01591	-85,99887	-24,194436	-43,163544	-120,752868	51,244872	-101,552436	70,445304
35	9	-17,28174	-14,01591	-85,99887	-24,194436	-43,163544	-120,752868	51,244872	-101,552436	70,445304
36	0	-10,15057	-9,515602	-67,80662	-14,210798	-27,4056472	-89,502906	46,110334	-76,942133	58,671107
36	2.25	-10,15057	-9,515602	67,80662	-14,210798	-27,4056472	-89,502906	46,110334	-76,942133	58,671107
36	4.5	-10,15057	-9,515602	-67,80662	-14,210798	-27,4056472	-89,502906	46,110334	-76,942133	58,671107
36	6.75	-10,15057	-9,515602	-67,80662	-14,210798	-27,4056472	-89,502906	46,110334	-76,942133	58,671107
36	9	-10,15057	-9,515602	-67,80662	-14,210798	-27,4056472	-89,502906	46,110334	-76,942133	58,671107
37	0	-11,06988	-10,20971	-49,61818	-15,497832	-29,619392	-73,111746	26,124614	-59,581072	39,655288
37	2.25	-11,06988	-10,20971	-49,61818	-15,497832	-29,619392	-73,111746	26,124614	-59,581072	39,655288
37	4.5	-11,06988	-10,20971	-49,61818	-15,497832	-29,619392	-73,111746	26,124614	-59,581072	39,655288
37	6.75	-11,06988	-10,20971	-49,61818	-15,497832	-29,619392	-73,111746	26,124614	-59,581072	39,655288
37	9	-11,06988	-10,20971	-49,61818	-15,497832	-29,619392	-73,111746	26,124614	-59,581072	39,655288
38	0	-15,56939	-14,61625	-31,28858	-21,797146	-42,069268	-64,588098	-2,010938	-45,301031	17,276129
38	2.25	-15,56939	-14,61625	-31,28858	-21,797146	-42,069268	-64,588098	-2,010938	-45,301031	17,276129
38	4.5	-15,56939	-14,61625	-31,28858	-21,797146	-42,069268	-64,588098	-2,010938	-45,301031	17,276129
38	6.75	-15,56939	-14,61625	-31,28858	-21,797146	-42,069268	-64,588098	-2,010938	-45,301031	17,276129
38	9	-15,56939	-14,61625	-31,28858	-21,797146	-42,069268	-64,588098	-2,010938	-45,301031	17,276129
39	0	-14,61469	-14,2182	-11,98903	-20,460566	-40,286748	-43,744858	-19,766798	-25,142251	-1,164191

Lampiran A10

39	1,8	-14,61469	-14,2182	-11,98903	-20,460566	-40,286748	-43,744858	-19,766798	-25,142251	-1,164191
39	3,6	-14,61469	-14,2182	-11,98903	-20,460566	-40,286748	-43,744858	-19,766798	-25,142251	-1,164191
39	5,4	-14,61469	-14,2182	-11,98903	-20,460566	-40,286748	-43,744858	-19,766798	-25,142251	-1,164191
39	7,2	-14,61469	-14,2182	-11,98903	-20,460566	-40,286748	-43,744858	-19,766798	-25,142251	-1,164191

AKSIAL BALOK PORTAL AS A (ANALISIS 2D)

LABEL	STATION	PD (KN)	PL (KN)	PE (KN)	1,4PD (KN)	1,2PD+1,6PL (KN)	1,2PD+PL+PE (KN)	1,2PD+PL - PE (KN)	0,9PD+PE (KN)	0,9PD-PE (KN)
1	0	4,727059	5,072043	-36,84793	6,6178826	13,7877396	-26,1034162	47,5924438	-32,5935769	41,1022831
1	1	4,727059	5,072043	-36,84792	6,6178826	13,7877396	-26,1034162	47,5924438	-32,5935769	41,1022831
1	2	4,727059	5,072043	-36,84793	6,6178826	13,7877396	-26,1034162	47,5924438	-32,5935769	41,1022831
1	3	4,727059	5,072043	-36,84793	6,6178826	13,7877396	-26,1034162	47,5924438	-32,5935769	41,1022831
1	4	4,727059	5,072043	-36,84793	6,6178826	13,7877396	-26,1034162	47,5924438	-32,5935769	41,1022831
2	0	11,09074	10,0143	54,97951	15,527036	29,331768	78,302698	-31,656322	64,961176	-44,997844
2	2	11,09074	10,0143	54,97951	15,527036	29,331768	78,302698	-31,656322	64,961176	-44,997844
2	4	11,09074	10,0143	54,97951	15,527036	29,331768	78,302698	-31,656322	64,961176	-44,997844
2	6	11,09074	10,0143	54,97951	15,527036	29,331768	78,302698	-31,656322	64,961176	-44,997844
2	8	11,09074	10,0143	54,97951	15,527036	29,331768	78,302698	-31,656322	64,961176	-44,997844
3	0	8,005392	8,169268	153,3675	11,2075488	22,6772992	171,1432384	-135,5917616	160,5723528	-146,1626472
3	2	8,005392	8,169268	153,3675	11,2075488	22,6772992	171,1432384	-135,5917616	160,5723528	-146,1626472
3	4	8,005392	8,169268	153,3675	11,2075488	22,6772992	171,1432384	-135,5917616	160,5723528	-146,1626472
3	6	8,005392	8,169268	153,3675	11,2075488	22,6772992	171,1432384	-135,5917616	160,5723528	-146,1626472
3	8	8,005392	8,169268	153,3675	11,2075488	22,6772992	171,1432384	-135,5917616	160,5723528	-146,1626472
4	0	-1,060219	-0,7562176	-153,404	-1,4843066	-2,48221096	-155,4324804	151,3755196	-154,3581971	152,4498029
4	1	-1,060219	-0,7562176	-153,404	-1,4843066	-2,48221096	-155,4324804	151,3755196	-154,3581971	152,4498029
4	2	-1,060219	-0,7562176	-153,404	-1,4843066	-2,48221096	-155,4324804	151,3755196	-154,3581971	152,4498029
4	3	-1,060219	-0,7562176	-153,404	-1,4843066	-2,48221096	-155,4324804	151,3755196	-154,3581971	152,4498029
4	4	-1,060219	-0,7562176	-153,404	-1,4843066	-2,48221096	-155,4324804	151,3755196	-154,3581971	152,4498029
5	0	-0,7468036	8,53E-02	-137,5816	-1,04552504	-0,759740608	-138,3924995	136,7707005	-138,2537232	136,9094768
5	2	-0,7468036	8,53E-02	-137,5816	-1,04552504	-0,759740608	-138,3924995	136,7707005	-138,2537232	136,9094768
5	4	-0,7468036	8,53E-02	-137,5816	-1,04552504	-0,759740608	-138,3924995	136,7707005	-138,2537232	136,9094768
5	6	-0,7468036	8,53E-02	-137,5816	-1,04552504	-0,759740608	-138,3924995	136,7707005	-138,2537232	136,9094768
5	8	-0,7468036	8,53E-02	-137,5816	-1,04552504	-0,759740608	-138,3924995	136,7707005	-138,2537232	136,9094768
6	0	-6,317474	-7,058127	113,7848	-8,8444636	18,873972	-128,4238958	99,1457042	-119,4705266	108,0990734
6	1	-6,317474	-7,058127	113,7848	-8,8444636	18,873972	-128,4238958	99,1457042	-119,4705266	108,0990734
6	2	-6,317474	-7,058127	113,7848	-8,8444636	18,873972	-128,4238958	99,1457042	-119,4705266	108,0990734
6	3	-6,317474	-7,058127	113,7848	-8,8444636	18,873972	-128,4238958	99,1457042	-119,4705266	108,0990734
6	4	-6,317474	-7,058127	113,7848	-8,8444636	18,873972	-128,4238958	99,1457042	-119,4705266	108,0990734
7	0	13,71667	13,83747	-290,1776	19,203338	38,599956	-259,880126	320,475074	-277,832597	302,522603
7	2,236058	3,321681	3,475471	-290,1776	4,6503534	9,5467708	-262,7161118	297,6390882	-287,1830871	293,1671129
7	4,472156	-12,37654	-13,02453	-290,1776	-17,327156	-35,691096	-318,053978	262,301222	-301,318486	279,038714
7	6,708204	-28,07476	-29,52453	-290,1776	-39,304664	-80,92896	-353,331842	226,963358	-315,444894	264,910316
7	8,944272	-41,38566	-43,37009	-290,1776	-57,939924	-119,054936	-383,210482	197,144718	-327,424694	252,930506
8	0	4,837087	5,163983	-131,2524	6,7719218	14,0668772	-120,2839126	142,2208874	-126,8990217	135,6057783

Lampiran A3

S	2.236068	-5,557898	-5,19801	-131,2524	-7,7810572	-14,9862936	-143,1198876	119,3849124	-136,2545062	126,2502918
S	4.472136	-21,25612	-21,69801	-131,2524	-29,758568	-60,22416	-178,457754	84,047046	-150,362908	112,121692
S	6.708204	-36,95434	-38,19801	-131,2524	-51,736076	-105,462024	-213,795618	48,709182	-164,511306	97,993494
S	8.944272	-50,26524	-52,04358	-131,2524	-70,371336	-143,588016	-243,614268	18,890532	-176,491116	86,013684

AKSIAL BALOK PORTAL AS 1 (ANALISIS 3D)

LABEL	STATION	PD (KN)	PL (KN)	PE (KN)	1,4PD (KN)	1,2PD+1,6PL (KN)	1,2PD+PL+PE (KN)	1,2PD+PL - PE (KN)	0,9PD+PE (KN)	0,9PD-PE (KN)
141	0	5,594138	1,866817	-88,51641	7,8317932	9,6998729	-79,9366274	97,0961926	-83,4816656	93,5511342
141	0,45	5,594138	1,866817	-88,51641	7,8317932	9,6998728	-79,9366274	97,0961926	-83,4816656	93,5511342
141	0,9	5,594138	1,866817	-88,51641	7,8317932	9,6998728	-79,9366274	97,0961926	-83,4816656	93,5511342
141	1,35	5,594138	1,866817	-88,51641	7,8317932	9,6998728	-79,9366274	97,0961926	-83,4816656	93,5511342
141	1,8	5,594138	1,866817	-88,51641	7,8317932	9,6998728	-79,9366274	97,0961926	-83,4816656	93,5511342
142	0	5,415458	1,709869	-220,6608	7,5816412	9,23434	-212,453814	228,8692186	-215,7868878	225,5347122
142	0,9	5,415458	1,709869	-220,6608	7,5816412	9,23434	-212,453814	228,8692186	-215,7868878	225,5347122
142	1,8	5,415458	1,709869	-220,6608	7,5816412	9,23434	-212,453814	228,8692186	-215,7868878	225,5347122
142	2,7	5,415458	1,709869	-220,6608	7,5816412	9,23434	-212,453814	228,8692186	-215,7868878	225,5347122
142	3,5	5,415458	1,709869	-220,6608	7,5816412	9,23434	-212,453814	228,8692186	-215,7868878	225,5347122
143	0	5,481672	1,771442	-223,2893	7,6743405	9,4123136	-214,9398516	231,6387484	-218,3557952	228,2228048
143	0,9	5,481672	1,771442	-223,2893	7,6743405	9,4123136	-214,9398516	231,6387484	-218,3557952	228,2228048
143	1,8	5,481672	1,771442	-223,2893	7,6743405	9,4123136	-214,9398516	231,6387484	-218,3557952	228,2228048
143	2,7	5,481672	1,771442	-223,2893	7,6743405	9,4123136	-214,9398516	231,6387484	-218,3557952	228,2228048
143	3,6	5,481672	1,771442	-223,2893	7,6743405	9,4123136	-214,9398516	231,6387484	-218,3557952	228,2228048
144	0	5,307617	1,774995	-214,8374	7,4306638	9,2091324	-206,6932646	222,9815354	-210,0605447	219,6142553
144	0,75	5,307617	1,774995	-214,8374	7,4306638	9,2091324	-206,6932646	222,9815354	-210,0605447	219,6142553
144	1,5	5,307617	1,774995	-214,8374	7,4306638	9,2091324	-206,6932646	222,9815354	-210,0605447	219,6142553
144	2,25	5,307617	1,774995	-214,8374	7,4306638	9,2091324	-206,6932646	222,9815354	-210,0605447	219,6142553
144	3	5,307617	1,774995	-214,8374	7,4306638	9,2091324	-206,6932646	222,9815354	-210,0605447	219,6142553
145	0	5,43155	1,888543	-213,4652	7,60417	9,5395288	-205,058797	221,871603	-208,576805	218,353595
145	0,75	5,43155	1,888543	-213,4652	7,60417	9,5395288	-205,058797	221,871603	-208,576805	218,353595
145	1,5	5,43155	1,888543	-213,4652	7,60417	9,5395288	-205,058797	221,871603	-208,576805	218,353595
145	2,25	5,43155	1,888543	-213,4652	7,60417	9,5395288	-205,058797	221,871603	-208,576805	218,353595
145	3	5,43155	1,888543	-213,4652	7,60417	9,5395288	-205,058797	221,871603	-208,576805	218,353595
145	0	5,243935	1,751802	-212,0458	7,341509	9,0956052	-204,001276	220,090324	-207,3262585	216,7653415
146	0,75	5,243935	1,751802	-212,0458	7,341509	9,0956052	-204,001276	220,090324	-207,3262585	216,7653415
146	1,5	5,243935	1,751802	-212,0458	7,341509	9,0956052	-204,001276	220,090324	-207,3262585	216,7653415
146	2,25	5,243935	1,751802	-212,0458	7,341509	9,0956052	-204,001276	220,090324	-207,3262585	216,7653415
146	3	5,243935	1,751802	-212,0458	7,341509	9,0956052	-204,001276	220,090324	-207,3262585	216,7653415
147	0	4,729134	1,582975	-193,0462	6,6207876	8,2077208	-185,7882642	200,3041358	-188,7899794	197,3024206
147	0,75	4,729134	1,582975	-193,0462	6,6207876	8,2077208	-185,7882642	200,3041358	-188,7899794	197,3024206
147	1,5	4,729134	1,582975	-193,0462	6,6207876	8,2077208	-185,7882642	200,3041358	-188,7899794	197,3024206
147	2,25	4,729134	1,582975	-193,0462	6,6207876	8,2077208	-185,7882642	200,3041358	-188,7899794	197,3024206
147	3	4,729134	1,582975	-193,0462	6,6207876	8,2077208	-185,7882642	200,3041358	-188,7899794	197,3024206

148	0	4,758544	1,626723	-191,6435	6,6619616	8,3130096	-184,3065242	198,9804758	-187,3608104	195,9261896
148	0,75	4,758544	1,626723	-191,6435	6,6619616	8,3130096	-184,3065242	198,9804758	-187,3608104	195,9261896
148	1,5	4,758544	1,626723	-191,6435	6,6619616	8,3130096	-184,3065242	198,9804758	-187,3608104	195,9261896
148	2,25	4,758544	1,626723	-191,6435	6,6619616	8,3130096	-184,3065242	198,9804758	-187,3608104	195,9261896
148	3	4,758544	1,626723	-191,6435	6,6619616	8,3130096	-184,3065242	198,9804758	-187,3608104	195,9261896
149	0	4,834728	1,7084	-190,1425	6,7686192	8,5351136	-182,6324264	197,6525736	-185,7912448	194,4937552
149	0,75	4,834728	1,7084	-190,1425	6,7686192	8,5351136	-182,6324264	197,6525736	-185,7912448	194,4937552
149	1,5	4,834728	1,7084	-190,1425	6,7686192	8,5351136	-182,6324264	197,6525736	-185,7912448	194,4937552
149	2,25	4,834728	1,7084	-190,1425	6,7686192	8,5351136	-182,6324264	197,6525736	-185,7912448	194,4937552
149	3	4,834728	1,7084	-190,1425	6,7686192	8,5351136	-182,6324264	197,6525736	-185,7912448	194,4937552
150	0	4,746798	1,716169	-172,7655	6,6455172	8,442028	-165,3531734	180,1778266	-168,4933818	177,0376182
150	0,75	4,746798	1,716169	-172,7655	6,6455172	8,442028	-165,3531734	180,1778266	-168,4933818	177,0376182
150	1,5	4,746798	1,716169	-172,7655	6,6455172	8,442028	-165,3531734	180,1778266	-168,4933818	177,0376182
150	2,25	4,746798	1,716169	-172,7655	6,6455172	8,442028	-165,3531734	180,1778266	-168,4933818	177,0376182
150	3	4,746798	1,716169	-172,7655	6,6455172	8,442028	-165,3531734	180,1778266	-168,4933818	177,0376182
151	0	4,709122	1,682564	-171,3897	6,5927708	8,3430488	-164,0561896	178,7232104	-167,1514902	175,6279098
151	0,75	4,709122	1,682564	-171,3897	6,5927708	8,3430488	-164,0561896	178,7232104	-167,1514902	175,6279098
151	1,5	4,709122	1,682564	-171,3897	6,5927708	8,3430488	-164,0561896	178,7232104	-167,1514902	175,6279098
151	2,25	4,709122	1,682564	-171,3897	6,5927708	8,3430488	-164,0561896	178,7232104	-167,1514902	175,6279098
151	3	4,709122	1,682564	-171,3897	6,5927708	8,3430488	-164,0561896	178,7232104	-167,1514902	175,6279098
152	0	4,677084	1,652475	-170,2218	6,5479176	8,2564608	-162,9568242	177,4867758	-166,0124244	174,4311756
152	0,75	4,677084	1,652475	-170,2218	6,5479176	8,2564608	-162,9568242	177,4867758	-166,0124244	174,4311756
152	1,5	4,677084	1,652475	-170,2218	6,5479176	8,2564608	-162,9568242	177,4867758	-166,0124244	174,4311756
152	2,25	4,677084	1,652475	-170,2218	6,5479176	8,2564608	-162,9568242	177,4867758	-166,0124244	174,4311756
152	3	4,677084	1,652475	-170,2218	6,5479176	8,2564608	-162,9568242	177,4867758	-166,0124244	174,4311756
153	0	4,257508	1,376276	-154,6354	5,9605112	7,3110512	-148,1501144	161,1206356	-150,8036428	158,4671572
153	0,75	4,257508	1,376276	-154,6354	5,9605112	7,3110512	-148,1501144	161,1206356	-150,8036428	158,4671572
153	1,5	4,257508	1,376276	-154,6354	5,9605112	7,3110512	-148,1501144	161,1206356	-150,8036428	158,4671572
153	2,25	4,257508	1,376276	-154,6354	5,9605112	7,3110512	-148,1501144	161,1206356	-150,8036428	158,4671572
153	3	4,257508	1,376276	-154,6354	5,9605112	7,3110512	-148,1501144	161,1206356	-150,8036428	158,4671572
154	0	4,252877	1,367971	-153,6503	5,9540278	7,292206	-147,1788766	160,1217334	-149,8227107	157,4778893
154	0,75	4,252877	1,367971	-153,6503	5,9540278	7,292206	-147,1788766	160,1217334	-149,8227107	157,4778893
154	1,5	4,252877	1,367971	-153,6503	5,9540278	7,292206	-147,1788766	160,1217334	-149,8227107	157,4778893
154	2,25	4,252877	1,367971	-153,6503	5,9540278	7,292206	-147,1788766	160,1217334	-149,8227107	157,4778893
154	3	4,252877	1,367971	-153,6503	5,9540278	7,292206	-147,1788766	160,1217334	-149,8227107	157,4778893
155	0	4,2677	1,392667	-152,4992	5,97478	7,3495072	-145,985293	159,013107	-148,66827	156,34013
155	0,75	4,2677	1,392667	-152,4992	5,97478	7,3495072	-145,985293	159,013107	-148,66827	156,34013
155	1,5	4,2677	1,392667	-152,4992	5,97478	7,3495072	-145,985293	159,013107	-148,66827	156,34013
155	2,25	4,2677	1,392667	-152,4992	5,97478	7,3495072	-145,985293	159,013107	-148,66827	156,34013

Lampiran A13

155	3	4,2677	1,392667	-152,4992	5,97478	7,3495072	-145,985293	159,013107	-148,65827	156,34013
156	0	4,191011	1,474421	-137,0757	5,8674154	7,3882868	-130,5720658	143,5793342	-133,3037901	140,8476099
156	0,75	4,191011	1,474421	-137,0757	5,8674154	7,3882868	-130,5720658	143,5793342	-133,3037901	140,8476099
156	1,5	4,191011	1,474421	-137,0757	5,8674154	7,3882868	-130,5720658	143,5793342	-133,3037901	140,8476099
156	2,25	4,191011	1,474421	-137,0757	5,8674154	7,3882868	-130,5720658	143,5793342	-133,3037901	140,8476099
156	3	4,191011	1,474421	-137,0757	5,8674154	7,3882868	-130,5720658	143,5793342	-133,3037901	140,8476099
157	0	4,225707	1,510285	-136,0014	5,9159898	7,4873044	-129,4202666	142,5825334	-132,1982637	139,8045363
157	0,75	4,225707	1,510285	-136,0014	5,9159898	7,4873044	-129,4202666	142,5825334	-132,1982637	139,8045363
157	1,5	4,225707	1,510285	-136,0014	5,9159898	7,4873044	-129,4202666	142,5825334	-132,1982637	139,8045363
157	2,25	4,225707	1,510285	-136,0014	5,9159898	7,4873044	-129,4202666	142,5825334	-132,1982637	139,8045363
157	3	4,225707	1,510285	-136,0014	5,9159898	7,4873044	-129,4202666	142,5825334	-132,1982637	139,8045363
158	0	4,278993	1,560584	-134,8731	5,9905902	7,631726	-128,1777244	141,5684756	-131,0220063	138,7241937
158	0,75	4,278993	1,560584	-134,8731	5,9905902	7,631726	-128,1777244	141,5684756	-131,0220063	138,7241937
158	1,5	4,278993	1,560584	-134,8731	5,9905902	7,631726	-128,1777244	141,5684756	-131,0220063	138,7241937
158	2,25	4,278993	1,560584	-134,8731	5,9905902	7,631726	-128,1777244	141,5684756	-131,0220063	138,7241937
158	3	4,278993	1,560584	-134,8731	5,9905902	7,631726	-128,1777244	141,5684756	-131,0220063	138,7241937
159	0	5,04863	1,795888	-119,604	7,068082	8,9317768	-111,749756	127,458244	-115,060233	124,147767
159	0,83	5,04863	1,795888	-119,604	7,068082	8,9317768	-111,749756	127,458244	-115,060233	124,147767
159	1,67	5,04863	1,795888	-119,604	7,068082	8,9317768	-111,749756	127,458244	-115,060233	124,147767
159	2,50	5,04863	1,795888	-119,604	7,068082	8,9317768	-111,749756	127,458244	-115,060233	124,147767
159	3,33	5,04863	1,795888	-119,604	7,068082	8,9317768	-111,749756	127,458244	-115,060233	124,147767
160	0	5,047351	1,796221	-118,5147	7,0662914	8,9307748	-110,6616578	126,3677422	-113,9720841	123,0573159
160	0,83	5,047351	1,796221	-118,5147	7,0662914	8,9307748	-110,6616578	126,3677422	-113,9720841	123,0573159
160	1,67	5,047351	1,796221	-118,5147	7,0662914	8,9307748	-110,6616578	126,3677422	-113,9720841	123,0573159
160	2,50	5,047351	1,796221	-118,5147	7,0662914	8,9307748	-110,6616578	126,3677422	-113,9720841	123,0573159
160	3,33	5,047351	1,796221	-118,5147	7,0662914	8,9307748	-110,6616578	126,3677422	-113,9720841	123,0573159
161	0	5,048791	1,798154	-117,4462	7,0683074	8,9355956	-109,5894968	125,3029032	-112,9022881	121,9901119
161	0,83	5,048791	1,798154	-117,4462	7,0683074	8,9355956	-109,5894968	125,3029032	-112,9022881	121,9901119
161	1,67	5,048791	1,798154	-117,4462	7,0683074	8,9355956	-109,5894968	125,3029032	-112,9022881	121,9901119
161	2,50	5,048791	1,798154	-117,4462	7,0683074	8,9355956	-109,5894968	125,3029032	-112,9022881	121,9901119
161	3,33	5,048791	1,798154	-117,4462	7,0683074	8,9355956	-109,5894968	125,3029032	-112,9022881	121,9901119
162	0	4,268207	1,552385	-102,5885	5,9754898	7,6056644	-95,9142666	109,2627334	-98,7471137	106,4298863
162	0,75	4,268207	1,552385	-102,5885	5,9754898	7,6056644	-95,9142666	109,2627334	-98,7471137	106,4298863
162	1,5	4,268207	1,552385	-102,5885	5,9754898	7,6056644	-95,9142666	109,2627334	-98,7471137	106,4298863
162	2,25	4,268207	1,552385	-102,5885	5,9754898	7,6056644	-95,9142666	109,2627334	-98,7471137	106,4298863
162	3	4,268207	1,552385	-102,5885	5,9754898	7,6056644	-95,9142666	109,2627334	-98,7471137	106,4298863
163	0	4,214784	1,504099	-101,401	5,9068976	7,4642992	-94,8391602	107,9628398	-97,6076944	105,1943056
163	0,75	4,214784	1,504099	-101,401	5,9068976	7,4642992	-94,8391602	107,9628398	-97,6076944	105,1943056
163	1,5	4,214784	1,504099	-101,401	5,9068976	7,4642992	-94,8391602	107,9628398	-97,6076944	105,1943056

Lampiran A13

163	2,25	4,214784	1,504099	-101,401	5,9006976	7,4542992	-94,8391602	107,9628398	-97,6076944	105,1943056
163	3	4,214784	1,504099	-101,401	5,9006976	7,4542992	-94,8391602	107,9628398	-97,6076944	105,1943056
164	0	4,180062	1,47035	-100,3557	5,8520868	7,3686344	-93,8692756	106,8421244	-96,5936442	104,1177558
164	0,75	4,180062	1,47035	-100,3557	5,8520868	7,3686344	-93,8692756	106,8421244	-96,5936442	104,1177558
164	1,5	4,180062	1,47035	-100,3557	5,8520868	7,3686344	-93,8692756	106,8421244	-96,5936442	104,1177558
164	2,25	4,180062	1,47035	-100,3557	5,8520868	7,3686344	-93,8692756	106,8421244	-96,5936442	104,1177558
164	3	4,180062	1,47035	-100,3557	5,8520868	7,3686344	-93,8692756	106,8421244	-96,5936442	104,1177558
165	0	4,245726	1,37798	-86,61906	5,9440164	7,2996392	-80,1462088	93,0919112	-82,7979066	90,4402134
165	0,75	4,245726	1,37798	-86,61906	5,9440164	7,2996392	-80,1462088	93,0919112	-82,7979066	90,4402134
165	1,5	4,245726	1,37798	-86,61906	5,9440164	7,2996392	-80,1462088	93,0919112	-82,7979066	90,4402134
165	2,25	4,245726	1,37798	-86,61906	5,9440164	7,2996392	-80,1462088	93,0919112	-82,7979066	90,4402134
165	3	4,245726	1,37798	-86,61906	5,9440164	7,2996392	-80,1462088	93,0919112	-82,7979066	90,4402134
166	0	4,230659	1,355228	-85,57182	5,9229226	7,2451556	-79,1398012	92,0038388	-81,7642269	89,3794131
166	0,75	4,230659	1,355228	-85,57182	5,9229226	7,2451556	-79,1398012	92,0038388	-81,7642269	89,3794131
166	1,5	4,230659	1,355228	-85,57182	5,9229226	7,2451556	-79,1398012	92,0038388	-81,7642269	89,3794131
166	2,25	4,230659	1,355228	-85,57182	5,9229226	7,2451556	-79,1398012	92,0038388	-81,7642269	89,3794131
166	3	4,230659	1,355228	-85,57182	5,9229226	7,2451556	-79,1398012	92,0038388	-81,7642269	89,3794131
167	0	4,235172	1,365573	-84,36134	5,9292408	7,2671232	-77,9135606	90,8091194	-80,5496852	88,1729948
167	0,75	4,235172	1,365573	-84,36134	5,9292408	7,2671232	-77,9135606	90,8091194	-80,5496852	88,1729948
167	1,5	4,235172	1,365573	-84,36134	5,9292408	7,2671232	-77,9135606	90,8091194	-80,5496852	88,1729948
167	2,25	4,235172	1,365573	-84,36134	5,9292408	7,2671232	-77,9135606	90,8091194	-80,5496852	88,1729948
167	3	4,235172	1,365573	-84,36134	5,9292408	7,2671232	-77,9135606	90,8091194	-80,5496852	88,1729948
168	0	4,644428	1,632396	-70,57466	6,5021992	8,1851472	-63,3689504	77,7803696	-66,3946748	74,7546452
168	0,75	4,644428	1,632396	-70,57466	6,5021992	8,1851472	-63,3689504	77,7803696	-66,3946748	74,7546452
168	1,5	4,644428	1,632396	-70,57466	6,5021992	8,1851472	-63,3689504	77,7803696	-66,3946748	74,7546452
168	2,25	4,644428	1,632396	-70,57466	6,5021992	8,1851472	-63,3689504	77,7803696	-66,3946748	74,7546452
168	3	4,644428	1,632396	-70,57466	6,5021992	8,1851472	-63,3689504	77,7803696	-66,3946748	74,7546452
169	0	4,67734	1,665461	-69,57946	6,548276	8,2775456	-62,301191	76,657729	-65,369854	73,789066
169	0,75	4,67734	1,665461	-69,57946	6,548276	8,2775456	-62,301191	76,657729	-65,369854	73,789066
169	1,5	4,67734	1,665461	-69,57946	6,548276	8,2775456	-62,301191	76,657729	-65,369854	73,789066
169	2,25	4,67734	1,665461	-69,57946	6,548276	8,2775456	-62,301191	76,657729	-65,369854	73,789066
169	3	4,67734	1,665461	-69,57946	6,548276	8,2775456	-62,301191	76,657729	-65,369854	73,789066
170	0	4,715727	1,701968	-68,51128	6,6020178	8,3820212	-61,1504396	75,8721204	-64,2671257	72,7554343
170	0,75	4,715727	1,701968	-68,51128	6,6020178	8,3820212	-61,1504396	75,8721204	-64,2671257	72,7554343
170	1,5	4,715727	1,701968	-68,51128	6,6020178	8,3820212	-61,1504396	75,8721204	-64,2671257	72,7554343
170	2,25	4,715727	1,701968	-68,51128	6,6020178	8,3820212	-61,1504396	75,8721204	-64,2671257	72,7554343
170	3	4,715727	1,701968	-68,51128	6,6020178	8,3820212	-61,1504396	75,8721204	-64,2671257	72,7554343
171	0	4,794507	1,683222	-54,55397	6,7123096	8,4465636	-47,1173396	61,9906004	-50,2389137	58,8690263
171	0,75	4,794507	1,683222	-54,55397	6,7123096	8,4465636	-47,1173396	61,9906004	-50,2389137	58,8690263

171	1.5	4,794,507	1,683,222	-54,553,97	6,712,3098	8,446,5636	-47,117,3396	61,990,6004	-50,235,9137	52,553,2222
171	2.25	4,794,507	1,683,222	-54,553,97	6,712,3098	8,446,5636	-47,117,3396	61,990,6004	-50,235,9137	52,553,2222
171	3	4,794,507	1,683,222	-54,553,97	6,712,3098	8,446,5636	-47,117,3396	61,990,6004	-50,235,9137	52,553,2222
172	0	4,717,959	1,603,912	-53,130,92	6,605,1426	8,227,81	-45,865,4572	60,396,3828	-48,884,7569	57,571,959
172	0.75	4,717,959	1,603,912	-53,130,92	6,605,1426	8,227,81	-45,865,4572	60,396,3828	-48,884,7569	57,571,959
172	1.5	4,717,959	1,603,912	-53,130,92	6,605,1426	8,227,81	-45,865,4572	60,396,3828	-48,884,7569	57,571,959
172	2.25	4,717,959	1,603,912	-52,130,92	6,605,1426	8,227,81	-45,865,4572	60,396,3828	-48,884,7569	57,571,959
172	3	4,717,959	1,603,912	-53,130,92	6,605,1426	8,227,81	-45,865,4572	60,396,3828	-48,884,7569	57,571,959
173	0	4,687,95	1,562,242	-51,83,845	6,563,13	8,125,1272	-44,650,668	59,026,232	-47,619,295	56,563,13
173	0.75	4,687,95	1,562,242	-51,83,845	6,563,13	8,125,1272	-44,650,668	59,026,232	-47,619,295	56,563,13
173	1.5	4,687,95	1,562,242	-51,83,845	6,563,13	8,125,1272	-44,650,668	59,026,232	-47,619,295	56,563,13
173	2.25	4,687,95	1,562,242	-51,63,845	6,563,13	8,125,1272	-44,650,668	59,026,232	-47,619,295	56,563,13
173	3	4,687,95	1,562,242	-51,83,845	6,563,13	8,125,1272	-44,650,668	59,026,232	-47,619,295	56,563,13
174	0	5,194,28	1,737,953	-38,44,712	7,271,992	9,013,8608	-30,476,031	46,418,209	-33,772,268	43,772,268
174	0.75	5,194,28	1,737,953	-38,44,712	7,271,992	9,013,8608	-30,476,031	46,418,209	-33,772,268	43,772,268
174	1.5	5,194,28	1,737,953	-38,44,712	7,271,992	9,013,8608	-30,476,031	46,418,209	-33,772,268	43,772,268
174	2.25	5,194,28	1,737,953	-38,44,712	7,271,992	9,013,8608	-30,476,031	46,418,209	-33,772,268	43,772,268
174	3	5,194,28	1,737,953	-38,44,712	7,271,992	9,013,8608	-30,476,031	46,418,209	-33,772,268	43,772,268
175	0	5,383,562	1,874,896	-37,50,866	7,536,9866	9,460,108	-29,173,4896	45,843,8304	-32,663,4542	42,536,9866
175	0.75	5,383,562	1,874,896	-37,50,866	7,536,9866	9,460,108	-29,173,4896	45,843,8304	-32,663,4542	42,536,9866
175	1.5	5,383,562	1,874,896	-37,50,866	7,536,9866	9,460,108	-29,173,4896	45,843,8304	-32,663,4542	42,536,9866
175	2.25	5,383,562	1,874,896	-37,50,866	7,536,9866	9,460,108	-29,173,4896	45,843,8304	-32,663,4542	42,536,9866
175	3	5,383,562	1,874,896	-37,50,866	7,536,9866	9,460,108	-29,173,4896	45,843,8304	-32,663,4542	42,536,9866
176	0	5,261,359	1,762,799	-36,63,12	7,365,9026	9,134,1092	-28,554,7702	44,707,6298	-31,895,9769	41,554,7702
176	0.75	5,261,359	1,762,799	-35,63,12	7,365,9026	9,134,1092	-28,554,7702	44,707,6298	-31,895,9769	41,554,7702
176	1.5	5,261,359	1,762,799	-36,63,12	7,365,9026	9,134,1092	-28,554,7702	44,707,6298	-31,895,9769	41,554,7702
176	2.25	5,261,359	1,762,799	-36,63,12	7,365,9026	9,134,1092	-28,554,7702	44,707,6298	-31,895,9769	41,554,7702
176	3	5,261,359	1,762,799	-36,63,12	7,365,9026	9,134,1092	-28,554,7702	44,707,6298	-31,895,9769	41,554,7702
177	0	5,381,854	1,592,767	-26,39,858	7,534,5956	9,006,652	-18,347,8882	34,449,8718	-21,555,2114	31,224,498
177	0.9	5,381,854	1,592,767	-26,39,858	7,534,5956	9,006,652	-18,347,8882	34,449,8718	-21,555,2114	31,224,498
177	1.8	5,381,854	1,592,767	-26,39,858	7,534,5956	9,006,652	-18,347,8882	34,449,8718	-21,555,2114	31,224,498
177	2.7	5,381,854	1,592,767	-26,39,888	7,534,5956	9,006,652	-18,347,8882	34,449,8718	-21,555,2114	31,224,498
177	3.6	5,381,854	1,592,767	-26,39,888	7,534,5956	9,006,652	-18,347,8882	34,449,8718	-21,555,2114	31,224,498
178	0	5,314,499	1,533,095	-28,30,313	7,440,2986	8,830,3508	-20,392,6362	36,213,6238	-23,520,0809	33,224,499
178	0.9	5,314,499	1,533,095	-28,30,313	7,440,2986	8,830,3508	-20,392,6362	36,213,6238	-23,520,0809	33,224,499
178	1.8	5,314,499	1,533,095	-28,30,313	7,440,2986	8,830,3508	-20,392,6362	36,213,6238	-23,520,0809	33,224,499
178	2.7	5,314,499	1,533,095	-28,30,313	7,440,2986	8,830,3508	-20,392,6362	36,213,6238	-23,520,0809	33,224,499
178	3.6	5,314,499	1,533,095	-28,30,313	7,440,2986	8,830,3508	-20,392,6362	36,213,6238	-23,520,0809	33,224,499
179	0	5,513,339	1,691,465	-29,84,28	7,718,6746	9,322,3508	-21,535,3282	38,150,2718	-24,880,7949	34,513,339

Lampiran A13

179	0,45	5.513339	1.691465	-29.8428	7.7186745	9.3223506	-21.5353282	38.1502718	-24.557949	34.8048051
179	0,9	5.513339	1.691465	-29.8428	7.7186746	9.3223508	-21.5353282	38.1502718	-24.557949	34.8048051
179	1,35	5.513339	1.691465	-29.8428	7.7186746	9.3223508	-21.5353282	38.1502718	-24.557949	34.8048051
179	1,8	5.513339	1.691465	-29.8428	7.7186746	9.3223508	-21.5353282	38.1502718	-24.557949	34.8048051
180	0	-1.589443	0.465533	-190.6964	-2.2252202	-1.1624788	-192.1381986	189.2546014	-192.256987	189.2659013
180	0,45	-1.589443	0.465533	-190.6964	-2.2252202	-1.1624788	-192.1381986	189.2546014	-192.256987	189.2659013
180	0,9	-1.589443	0.465533	-190.6964	-2.2252202	-1.1624788	-192.1381986	189.2546014	-192.256987	189.2659013
180	1,35	-1.589443	0.465533	-190.6964	-2.2252202	-1.1624788	-192.1381986	189.2546014	-192.256987	189.2659013
180	1,8	-1.589443	0.465533	-190.6964	-2.2252202	-1.1624788	-192.1381986	189.2546014	-192.256987	189.2659013
181	0	-1.60453	0.454545	-192.6976	-2.246342	-1.1981616	-194.1684895	191.2267105	-194.21677	191.253523
181	0,9	-1.60453	0.454545	-192.6976	-2.246342	-1.1981616	-194.1684895	191.2267105	-194.21677	191.253523
181	1,8	-1.60453	0.454545	-192.6976	-2.246342	-1.1981616	-194.1684895	191.2267105	-194.21677	191.253523
181	2,7	-1.60453	0.454545	-192.6976	-2.246342	-1.1981616	-194.1684895	191.2267105	-194.21677	191.253523
181	3,6	-1.60453	0.454545	-192.6976	-2.246342	-1.1981616	-194.1684895	191.2267105	-194.21677	191.253523
182	0	-1.525003	0.515173	-197.3307	-2.1350042	-1.0057188	-198.6455256	196.0156744	-199.332027	195.9581973
182	0,9	-1.525003	0.515173	-197.3307	-2.1350042	-1.0057188	-198.6455256	196.0156744	-199.332027	195.9581973
182	1,8	-1.525003	0.515173	-197.3307	-2.1350042	-1.0057188	-198.6455256	196.0156744	-199.332027	195.9581973
182	2,7	-1.525003	0.515173	-197.3307	-2.1350042	-1.0057188	-198.6455256	196.0156744	-199.332027	195.9581973
182	3,6	-1.525003	0.515173	-197.3307	-2.1350042	-1.0057188	-198.6455256	196.0156744	-199.332027	195.9581973
183	0	-0.6779357	0.6960545	-188.0332	-0.94910998	0.30016452	-188.1506682	187.9157318	-188.5433421	187.4230579
183	0,75	-0.6779357	0.6960545	-188.0332	-0.94910998	0.30016452	-188.1506682	187.9157318	-188.5433421	187.4230579
183	1,5	-0.6779357	0.6960545	-188.0332	-0.94910998	0.30016452	-188.1506682	187.9157318	-188.5433421	187.4230579
183	2,25	-0.6779357	0.6960545	-188.0332	-0.94910998	0.30016452	-188.1506682	187.9157318	-188.5433421	187.4230579
183	3	-0.6779357	0.6960545	-188.0332	-0.94910998	0.30016452	-188.1506682	187.9157318	-188.5433421	187.4230579
184	0	-0.4554134	0.889804	-186.3626	-0.63757876	0.87719046	-186.019292	186.705908	-188.7724721	185.9527279
184	0,75	-0.4554134	0.889804	-186.3626	-0.63757876	0.87719046	-186.019292	186.705908	-188.7724721	185.9527279
184	1,5	-0.4554134	0.889804	-186.3626	-0.63757876	0.87719046	-186.019292	186.705908	-188.7724721	185.9527279
184	2,25	-0.4554134	0.889804	-186.3626	-0.63757876	0.87719046	-186.019292	186.705908	-188.7724721	185.9527279
184	3	-0.4554134	0.889804	-186.3626	-0.63757876	0.87719046	-186.019292	186.705908	-188.7724721	185.9527279
185	0	-0.7052083	0.6849346	-185.1398	-0.98729162	0.2496454	-185.3011154	184.9784846	-188.7744875	184.5051125
185	0,75	-0.7052083	0.6849346	-185.1398	-0.98729162	0.2496454	-185.3011154	184.9784846	-188.7744875	184.5051125
185	1,5	-0.7052083	0.6849346	-185.1398	-0.98729162	0.2496454	-185.3011154	184.9784846	-188.7744875	184.5051125
185	2,25	-0.7052083	0.6849346	-185.1398	-0.98729162	0.2496454	-185.3011154	184.9784846	-188.7744875	184.5051125
185	3	-0.7052083	0.6849346	-185.1398	-0.98729162	0.2496454	-185.3011154	184.9784846	-188.7744875	184.5051125
186	0	-1.39807	0.1846889	-171.1887	-1.957296	-1.38218176	-172.6816951	169.6957049	-172.446963	169.930437
186	0,75	-1.39807	0.1846889	-171.1887	-1.957296	-1.38218176	-172.6816951	169.6957049	-172.446963	169.930437
186	1,5	-1.39807	0.1846889	-171.1887	-1.957296	-1.38218176	-172.6816951	169.6957049	-172.446963	169.930437
186	2,25	-1.39807	0.1846889	-171.1887	-1.957296	-1.38218176	-172.6816951	169.6957049	-172.446963	169.930437
186	3	-1.39807	0.1846889	-171.1887	-1.957296	-1.38218176	-172.6816951	169.6957049	-172.446963	169.930437

Lampiran A13

187	0	-1,413303	0,1807226	-169,602	-1,9766242	-1,40680744	-171,317241	168,266759	-171,0739727	166,5300273
187	0,75	-1,413303	0,1807226	-169,602	-1,9766242	-1,40680744	-171,317241	168,266759	-171,0739727	166,5300273
187	1,5	-1,413303	0,1807226	-169,602	-1,9766242	-1,40680744	-171,317241	168,266759	-171,0739727	166,5300273
187	2,25	-1,413303	0,1807226	-169,602	-1,9766242	-1,40680744	-171,317241	168,266759	-171,0739727	166,5300273
187	3	-1,413303	0,1807226	-169,602	-1,9766242	-1,40680744	-171,317241	168,266759	-171,0739727	166,5300273
188	0	-1,371823	0,2238274	-168,2068	-1,9205522	-1,28806376	-169,6311602	166,7864398	-169,4434407	166,9741593
188	0,75	-1,371823	0,2238274	-168,2068	-1,9205522	-1,28806376	-169,6311602	166,7864398	-169,4434407	166,9741593
188	1,5	-1,371823	0,2238274	-168,2068	-1,9205522	-1,28806376	-169,6311602	166,7864398	-169,4434407	166,9741593
188	2,25	-1,371823	0,2238274	-168,2068	-1,9205522	-1,28806376	-169,6311602	166,7864398	-169,4434407	166,9741593
188	3	-1,371823	0,2238274	-168,2068	-1,9205522	-1,28806376	-169,6311602	166,7864398	-169,4434407	166,9741593
189	0	-1,295502	0,210474	-150,9348	-1,8137028	-1,2127844	-152,2789284	149,5906716	-152,1007518	149,7688482
189	0,75	-1,295502	0,210474	-150,9348	-1,8137028	-1,2127844	-152,2789284	149,5906716	-152,1007518	149,7688482
189	1,5	-1,295502	0,210474	-150,9348	-1,8137028	-1,2127844	-152,2789284	149,5906716	-152,1007518	149,7688482
189	2,25	-1,295502	0,210474	-150,9348	-1,8137028	-1,2127844	-152,2789284	149,5906716	-152,1007518	149,7688482
189	3	-1,295502	0,210474	-150,9348	-1,8137028	-1,2127844	-152,2789284	149,5906716	-152,1007518	149,7688482
190	0	-1,317263	0,1845334	-149,1794	-1,8441682	-1,28546216	-150,5756822	147,7832176	-150,3649367	147,9938633
190	0,75	-1,317263	0,1845334	-149,1794	-1,8441682	-1,28546216	-150,5756822	147,7832176	-150,3649367	147,9938633
190	1,5	-1,317263	0,1845334	-149,1794	-1,8441682	-1,28546216	-150,5756822	147,7832176	-150,3649367	147,9938633
190	2,25	-1,317263	0,1845334	-149,1794	-1,8441682	-1,28546216	-150,5756822	147,7832176	-150,3649367	147,9938633
190	3	-1,317263	0,1845334	-149,1794	-1,8441682	-1,28546216	-150,5756822	147,7832176	-150,3649367	147,9938633
191	0	-1,303608	0,1872253	-147,6008	-1,8250512	-1,26476912	-148,9779043	146,2236957	-148,7740472	146,4275528
191	0,75	-1,303608	0,1872253	-147,6008	-1,8250512	-1,26476912	-148,9779043	146,2236957	-148,7740472	146,4275528
191	1,5	-1,303608	0,1872253	-147,6008	-1,8250512	-1,26476912	-148,9779043	146,2236957	-148,7740472	146,4275528
191	2,25	-1,303608	0,1872253	-147,6008	-1,8250512	-1,26476912	-148,9779043	146,2236957	-148,7740472	146,4275528
191	3	-1,303608	0,1872253	-147,6008	-1,8250512	-1,26476912	-148,9779043	146,2236957	-148,7740472	146,4275528
192	0	-0,9672206	0,4459983	-132,6333	-1,35410884	-0,44706744	-133,3479664	131,9186336	-133,5037985	131,7628015
192	0,75	-0,9672206	0,4459983	-132,6333	-1,35410884	-0,44706744	-133,3479664	131,9186336	-133,5037985	131,7628015
192	1,5	-0,9672206	0,4459983	-132,6333	-1,35410884	-0,44706744	-133,3479664	131,9186336	-133,5037985	131,7628015
192	2,25	-0,9672206	0,4459983	-132,6333	-1,35410884	-0,44706744	-133,3479664	131,9186336	-133,5037985	131,7628015
192	3	-0,9672206	0,4459983	-132,6333	-1,35410884	-0,44706744	-133,3479664	131,9186336	-133,5037985	131,7628015
193	0	-0,7506963	0,6250392	-131,3099	-1,05097482	0,06922716	-131,5856964	131,0341036	-131,9855267	130,6342733
193	0,75	-0,7506963	0,6250392	-131,3099	-1,05097482	0,06922716	-131,5856964	131,0341036	-131,9855267	130,6342733
193	1,5	-0,7506963	0,6250392	-131,3099	-1,05097482	0,06922716	-131,5856964	131,0341036	-131,9855267	130,6342733
193	2,25	-0,7506963	0,6250392	-131,3099	-1,05097482	0,06922716	-131,5856964	131,0341036	-131,9855267	130,6342733
193	3	-0,7506963	0,6250392	-131,3099	-1,05097482	0,06922716	-131,5856964	131,0341036	-131,9855267	130,6342733
194	0	-0,9636817	0,4481301	-130,2413	-1,34915436	-0,4394988	-130,9495879	129,5330121	-131,1086135	129,3739865
194	0,75	-0,9636817	0,4481301	-130,2413	-1,34915436	-0,4394988	-130,9495879	129,5330121	-131,1086135	129,3739865
194	1,5	-0,9636817	0,4481301	-130,2413	-1,34915436	-0,4394988	-130,9495879	129,5330121	-131,1086135	129,3739865
194	2,25	-0,9636817	0,4481301	-130,2413	-1,34915436	-0,4394988	-130,9495879	129,5330121	-131,1086135	129,3739865

Lampiran A13

202	2,25	-1,255778	0,1069536	-77,08511	-1,7580892	-1,33580784	-78,48509	75,68513	-5,2153102	75,9549098
202	3	-1,255778	0,1069536	-77,08511	-1,7580892	-1,33580784	-78,48509	75,68513	-5,2153102	75,9549098
203	0	-1,22871	0,1327135	-75,76333	-1,720194	-1,2621104	-77,1050685	74,4215915	-75,869169	74,657491
203	0,75	-1,22871	0,1327135	-75,76333	-1,720194	-1,2621104	-77,1050685	74,4215915	-75,869169	74,657491
203	1,5	-1,22871	0,1327135	-75,76333	-1,720194	-1,2621104	-77,1050685	74,4215915	-75,869169	74,657491
203	2,25	-1,22871	0,1327135	-75,76333	-1,720194	-1,2621104	-77,1050685	74,4215915	-75,869169	74,657491
203	3	-1,22871	0,1327135	-75,76333	-1,720194	-1,2621104	-77,1050685	74,4215915	-75,869169	74,657491
204	0	-0,9980564	0,411777	-59,1687	-1,39727895	-0,53882448	-59,95459068	58,38280932	-60,06695076	58,27044924
204	0,75	-0,9980564	0,411777	-59,1687	-1,39727895	-0,53882448	-59,95459068	58,38280932	-60,06695076	58,27044924
204	1,5	-0,9980564	0,411777	-59,1687	-1,39727895	-0,53882448	-59,95459068	58,38280932	-60,06695076	58,27044924
204	2,25	-0,9980564	0,411777	-59,1687	-1,39727895	-0,53882448	-59,95459068	58,38280932	-60,06695076	58,27044924
204	3	-0,9980564	0,411777	-59,1687	-1,39727895	-0,53882448	-59,95459068	58,38280932	-60,06695076	58,27044924
205	0	-0,7852744	0,5904987	-57,58324	-1,09938416	0,00246864	-57,93507058	57,23140942	-55,28998696	56,87649304
205	0,75	-0,7852744	0,5904987	-57,58324	-1,09938416	0,00246864	-57,93507058	57,23140942	-55,28998696	56,87649304
205	1,5	-0,7852744	0,5904987	-57,58324	-1,09938416	0,00246864	-57,93507058	57,23140942	-55,28998696	56,87649304
205	2,25	-0,7852744	0,5904987	-57,58324	-1,09938416	0,00246864	-57,93507058	57,23140942	-55,28998696	56,87649304
205	3	-0,7852744	0,5904987	-57,58324	-1,09938416	0,00246864	-57,93507058	57,23140942	-55,28998696	56,87649304
206	0	-1,002244	0,4130717	-56,35452	-1,4031416	-0,54177808	-57,1442411	55,5649989	-57,2566396	55,4526004
206	0,75	-1,002244	0,4130717	-56,35452	-1,4031416	-0,54177808	-57,1442411	55,5649989	-57,2566396	55,4526004
206	1,5	-1,002244	0,4130717	-56,35452	-1,4031416	-0,54177808	-57,1442411	55,5649989	-57,2566396	55,4526004
206	2,25	-1,002244	0,4130717	-56,35452	-1,4031416	-0,54177808	-57,1442411	55,5649989	-57,2566396	55,4526004
206	3	-1,002244	0,4130717	-56,35452	-1,4031416	-0,54177808	-57,1442411	55,5649989	-57,2566396	55,4526004
207	0	-1,355104	0,1330032	-41,03226	-1,8971456	-1,41331968	-42,5253816	39,5391384	-42,2518536	39,8126664
207	0,75	-1,355104	0,1330032	-41,03226	-1,8971456	-1,41331968	-42,5253816	39,5391384	-42,2518536	39,8126664
207	1,5	-1,355104	0,1330032	-41,03226	-1,8971456	-1,41331968	-42,5253816	39,5391384	-42,2518536	39,8126664
207	2,25	-1,355104	0,1330032	-41,03226	-1,8971456	-1,41331968	-42,5253816	39,5391384	-42,2518536	39,8126664
207	3	-1,355104	0,1330032	-41,03226	-1,8971456	-1,41331968	-42,5253816	39,5391384	-42,2518536	39,8126664
208	0	-1,367688	0,1333764	-39,89456	-1,9147632	-1,42782336	-41,4022092	38,3865108	-41,1252792	38,6634408
208	0,75	-1,367688	0,1333764	-39,89456	-1,9147632	-1,42782336	-41,4022092	38,3865108	-41,1252792	38,6634408
208	1,5	-1,367688	0,1333764	-39,89456	-1,9147632	-1,42782336	-41,4022092	38,3865108	-41,1252792	38,6634408
208	2,25	-1,367688	0,1333764	-39,89456	-1,9147632	-1,42782336	-41,4022092	38,3865108	-41,1252792	38,6634408
208	3	-1,367688	0,1333764	-39,89456	-1,9147632	-1,42782336	-41,4022092	38,3865108	-41,1252792	38,6634408
209	0	-1,344674	0,1626823	-38,53489	-1,8825436	-1,35331712	-39,9858165	37,0839635	-39,7450966	37,3246834
209	0,75	-1,344674	0,1626823	-38,53489	-1,8825436	-1,35331712	-39,9858165	37,0839635	-39,7450966	37,3246834
209	1,5	-1,344674	0,1626823	-38,53489	-1,8825436	-1,35331712	-39,9858165	37,0839635	-39,7450966	37,3246834
209	2,25	-1,344674	0,1626823	-38,53489	-1,8825436	-1,35331712	-39,9858165	37,0839635	-39,7450966	37,3246834
209	3	-1,344674	0,1626823	-38,53489	-1,8825436	-1,35331712	-39,9858165	37,0839635	-39,7450966	37,3246834
210	0	-1,442493	0,1528981	-19,9698	-2,0194962	-1,48635464	-21,4478935	18,2917065	-21,1680437	18,5715563
210	0,75	-1,442493	0,1528981	-19,9698	-2,0194962	-1,48635464	-21,4478935	18,2917065	-21,1680437	18,5715563

Lampiran A13

210	1.5	-1,442493	0,1528981	-19,8698	-2,0194902	-1,48635464	-21,4478935	16,2517065	-21,1680437	16,5715563
210	2.25	-1,442493	0,1528981	-19,8698	-2,0194902	-1,48635464	-21,4478935	18,2517065	-21,1680437	16,5715563
210	3	-1,442493	0,1528981	-19,8698	-2,0194902	-1,48635464	-21,4478935	18,2517065	-21,1680437	16,5715563
211	0	-1,48483	0,111676	-17,88431	-2,078762	-1,6031144	-19,55443	16,21419	-19,220657	16,547963
211	0.75	-1,48483	0,111676	-17,88431	-2,078762	-1,6031144	-19,55443	16,21419	-19,220657	16,547963
211	1.5	-1,48483	0,111676	17,88431	-2,078762	-1,6031144	-19,55443	16,21419	-19,220657	16,547963
211	2.25	-1,48483	0,111676	-17,88431	-2,078762	-1,6031144	-19,55443	16,21419	-19,220657	16,547963
211	3	-1,48483	0,111676	-17,88431	-2,078762	-1,6031144	-19,55443	16,21419	-19,220657	16,547963
212	0	-1,47077	0,1171926	-15,95738	-2,059078	-1,57741584	-17,5051114	14,3096486	-17,281073	14,633687
212	0.75	-1,47077	0,1171926	-15,95738	-2,059078	-1,57741584	-17,5051114	14,3096486	-17,281073	14,633687
212	1.5	-1,47077	0,1171926	-15,95738	-2,059078	-1,57741584	-17,5051114	14,3096486	-17,281073	14,633687
212	2.25	-1,47077	0,1171926	-15,95738	-2,059078	-1,57741584	-17,5051114	14,3096486	-17,281073	14,633687
212	3	-1,47077	0,1171926	-15,95738	-2,059078	-1,57741584	-17,5051114	14,3096486	-17,281073	14,633687
213	0	-0,7706441	0,6131069	1,790628	-1,0759074	0,05619812	1,47896198	-2,10229402	1,09704831	-2,48420769
213	0.75	-0,7706441	0,6131069	1,790628	-1,0759074	0,05619812	1,47896198	-2,10229402	1,09704831	-2,48420769
213	1.5	-0,7706441	0,6131069	1,790628	-1,0759074	0,05619812	1,47896198	-2,10229402	1,09704831	-2,48420769
213	2.25	-0,7706441	0,6131069	1,790628	-1,0759074	0,05619812	1,47896198	-2,10229402	1,09704831	-2,48420769
213	3	-0,7706441	0,6131069	1,790628	-1,0759074	0,05619812	1,47896198	-2,10229402	1,09704831	-2,48420769
214	0	-0,5213801	0,8179306	3,348131	-0,72593214	0,66303284	3,54040548	-3,15585652	2,87888891	-3,81737309
214	0.75	-0,5213801	0,8179306	3,348131	-0,72593214	0,66303284	3,54040548	-3,15585652	2,87888891	-3,81737309
214	1.5	-0,5213801	0,8179306	3,348131	-0,72593214	0,66303284	3,54040548	-3,15585652	2,87888891	-3,81737309
214	2.25	-0,5213801	0,8179306	3,348131	-0,72593214	0,66303284	3,54040548	-3,15585652	2,87888891	-3,81737309
214	3	-0,5213801	0,8179306	3,348131	-0,72593214	0,66303284	3,54040548	-3,15585652	2,87888891	-3,81737309
215	0	-0,7429649	0,6223622	4,542645	-1,04015086	0,10422164	4,27344932	-4,81184068	3,87397659	-5,21131341
215	0.75	-0,7429649	0,6223622	4,542645	-1,04015086	0,10422164	4,27344932	-4,81184068	3,87397659	-5,21131341
215	1.5	-0,7429649	0,6223622	4,542645	-1,04015086	0,10422164	4,27344932	-4,81184068	3,87397659	-5,21131341
215	2.25	-0,7429649	0,6223622	4,542645	-1,04015086	0,10422164	4,27344932	-4,81184068	3,87397659	-5,21131341
215	3	-0,7429649	0,6223622	4,542645	-1,04015086	0,10422164	4,27344932	-4,81184068	3,87397659	-5,21131341
216	0	-1,754951	0,281152	18,33301	-2,4563314	-1,656098	16,5082208	-20,1577992	16,7535541	-19,9124659
216	0.9	-1,754951	0,281152	18,33301	-2,4563314	-1,656098	16,5082208	-20,1577992	16,7535541	-19,9124659
216	1.8	-1,754951	0,281152	18,33301	-2,4563314	-1,656098	16,5082208	-20,1577992	16,7535541	-19,9124659
216	2.7	-1,754951	0,281152	18,33301	-2,4563314	-1,656098	16,5082208	-20,1577992	16,7535541	-19,9124659
216	3.6	-1,754951	0,281152	18,33301	-2,4563314	-1,656098	16,5082208	-20,1577992	16,7535541	-19,9124659
217	0	-1,83404	0,2144039	15,1171	-2,567656	-1,85780176	13,1306559	-17,1035441	13,466464	-15,767736
217	0.9	-1,83404	0,2144039	15,1171	-2,567656	-1,85780176	13,1306559	-17,1035441	13,466464	-15,767736
217	1.8	-1,83404	0,2144039	15,1171	-2,567656	-1,85780176	13,1306559	-17,1035441	13,466464	-15,767736
217	2.7	-1,83404	0,2144039	15,1171	-2,567656	-1,85780176	13,1306559	-17,1035441	13,466464	-15,767736
217	3.6	-1,83404	0,2144039	15,1171	-2,567656	-1,85780176	13,1306559	-17,1035441	13,466464	-15,767736
218	0	-1,823918	0,2221808	13,46004	-2,5534552	-1,8332126	11,4935189	-15,4265511	11,8185138	-15,1015662

218	0,45	-1.823918	0,2221805	13,46004	-2,5534852	-1,8332128	11,4935189	-15,4265611	11,8185138	-15,1015662
218	0,9	-1.823918	0,2221805	13,46004	-2,5534852	-1,8332128	11,4935189	-15,4265611	11,8185138	-15,1015662
218	1,35	-1.823918	0,2221805	13,46004	-2,5534852	-1,8332128	11,4935189	-15,4265611	11,8185138	-15,1015662
218	1,8	-1.823918	0,2221805	13,46004	-2,5534852	-1,8332128	11,4935189	-15,4265611	11,8185138	-15,1015662
219	0	-6,624053	-3,011278	-221,1964	-9,2736742	-12,7669084	-232,1565416	210,2362584	-227,1580477	215,2347523
219	0,45	-6,624053	-3,011278	-221,1964	-9,2736742	-12,7669084	-232,1565416	210,2362584	-227,1580477	215,2347523
219	0,9	-6,624053	-3,011278	-221,1964	-9,2736742	-12,7669084	-232,1565416	210,2362584	-227,1580477	215,2347523
219	1,35	-6,624053	-3,011278	-221,1964	-9,2736742	-12,7669084	-232,1565416	210,2362584	-227,1580477	215,2347523
219	1,8	-6,624053	-3,011278	-221,1964	-9,2736742	-12,7669084	-232,1565416	210,2362584	-227,1580477	215,2347523
220	0	-6,380989	-2,776321	-223,3434	-8,9333846	-12,0993004	-233,7769078	212,9098922	-229,0862901	217,6005099
220	0,9	-6,380989	-2,776321	-223,3434	-8,9333846	-12,0993004	-233,7769078	212,9098922	-229,0862901	217,6005099
220	1,8	-6,380989	-2,776321	-223,3434	-8,9333846	-12,0993004	-233,7769078	212,9098922	-229,0862901	217,6005099
220	2,7	-6,380989	-2,776321	-223,3434	-8,9333846	-12,0993004	-233,7769078	212,9098922	-229,0862901	217,6005099
220	3,6	-6,380989	-2,776321	-223,3434	-8,9333846	-12,0993004	-233,7769078	212,9098922	-229,0862901	217,6005099
221	0	-6,356715	-2,785004	-227,8846	-8,899401	-12,0840644	-238,297662	217,471538	-233,6056435	222,1635565
221	0,9	-6,356715	-2,785004	-227,8846	-8,899401	-12,0840644	-238,297662	217,471538	-233,6056435	222,1635565
221	1,8	-6,356715	-2,785004	-227,8846	-8,899401	-12,0840644	-238,297662	217,471538	-233,6056435	222,1635565
221	2,7	-6,356715	-2,785004	-227,8846	-8,899401	-12,0840644	-238,297662	217,471538	-233,6056435	222,1635565
221	3,6	-6,356715	-2,785004	-227,8846	-8,899401	-12,0840644	-238,297662	217,471538	-233,6056435	222,1635565
222	0	-5,567134	-1,965834	-214,3512	-7,7939876	-9,8258952	-222,9975948	205,7048052	-219,3616206	209,3407794
222	0,75	-5,567134	-1,965834	-214,3512	-7,7939876	-9,8258952	-222,9975948	205,7048052	-219,3616206	209,3407794
222	1,5	-5,567134	-1,965834	-214,3512	-7,7939876	-9,8258952	-222,9975948	205,7048052	-219,3616206	209,3407794
222	2,25	-5,567134	-1,965834	-214,3512	-7,7939876	-9,8258952	-222,9975948	205,7048052	-219,3616206	209,3407794
222	3	-5,567134	-1,965834	-214,3512	-7,7939876	-9,8258952	-222,9975948	205,7048052	-219,3616206	209,3407794
223	0	-5,654634	-2,062696	-212,1666	-7,9164876	-10,0858744	-221,0148568	203,3163432	-217,2557706	207,0774294
223	0,75	-5,654634	-2,062696	-212,1666	-7,9164876	-10,0858744	-221,0148568	203,3163432	-217,2557706	207,0774294
223	1,5	-5,654634	-2,062696	-212,1666	-7,9164876	-10,0858744	-221,0148568	203,3163432	-217,2557706	207,0774294
223	2,25	-5,654634	-2,062696	-212,1666	-7,9164876	-10,0858744	-221,0148568	203,3163432	-217,2557706	207,0774294
223	3	-5,654634	-2,062696	-212,1666	-7,9164876	-10,0858744	-221,0148568	203,3163432	-217,2557706	207,0774294
224	0	-5,964119	-2,282666	-210,1141	-8,3497666	-10,8092084	-219,5537088	200,6744912	-215,4818071	204,7463929
224	0,75	-5,964119	-2,282666	-210,1141	-8,3497666	-10,8092084	-219,5537088	200,6744912	-215,4818071	204,7463929
224	1,5	-5,964119	-2,282666	-210,1141	-8,3497666	-10,8092084	-219,5537088	200,6744912	-215,4818071	204,7463929
224	2,25	-5,964119	-2,282666	-210,1141	-8,3497666	-10,8092084	-219,5537088	200,6744912	-215,4818071	204,7463929
224	3	-5,964119	-2,282666	-210,1141	-8,3497666	-10,8092084	-219,5537088	200,6744912	-215,4818071	204,7463929
225	0	-6,090211	-2,596583	-191,8623	-8,5262954	-11,462786	-201,7671362	181,9574638	-197,3434899	186,3811101
225	0,75	-6,090211	-2,596583	-191,8623	-8,5262954	-11,462786	-201,7671362	181,9574638	-197,3434899	186,3811101
225	1,5	-6,090211	-2,596583	-191,8623	-8,5262954	-11,462786	-201,7671362	181,9574638	-197,3434899	186,3811101
225	2,25	-6,090211	-2,596583	-191,8623	-8,5262954	-11,462786	-201,7671362	181,9574638	-197,3434899	186,3811101
225	3	-6,090211	-2,596583	-191,8623	-8,5262954	-11,462786	-201,7671362	181,9574638	-197,3434899	186,3811101

226	0	-6.083358	-2.585538	-189.1186	-8.5167012	-11.4368904	-199.0041676	179.2330324	-194.5936222	163.6435778
226	0,75	-6.083358	-2.585538	-189.1186	-8.5167012	-11.4368904	-199.0041676	179.2330324	-194.5936222	163.6435778
226	1,5	-6.083358	-2.585538	-189.1186	-8.5167012	-11.4368904	-199.0041676	179.2330324	-194.5936222	163.6435778
226	2,25	-6.083358	-2.585538	-189.1186	-8.5167012	-11.4368904	-199.0041676	179.2330324	-194.5936222	163.6435778
226	3	-6.083358	-2.585538	-189.1186	-8.5167012	-11.4368904	-199.0041676	179.2330324	-194.5936222	163.6435778
227	0	-6.196262	-2.699288	-186.8568	-8.6747666	-11.7543752	-196.9916024	176.7219976	-192.4334358	181.2801642
227	0,75	-6.196262	-2.699288	-186.8568	-8.6747666	-11.7543752	-196.9916024	176.7219976	-192.4334358	181.2801642
227	1,5	-6.196262	-2.699288	-186.8568	-8.6747666	-11.7543752	-196.9916024	176.7219976	-192.4334358	181.2801642
227	2,25	-6.196262	-2.699288	-186.8568	-8.6747666	-11.7543752	-196.9916024	176.7219976	-192.4334358	181.2801642
227	3	-6.196262	-2.699288	-186.8568	-8.6747666	-11.7543752	-196.9916024	176.7219976	-192.4334358	181.2801642
228	0	-6.139435	-2.630962	-168.6048	-8.595209	-11.5768612	-178.603084	158.606516	-174.1302915	163.0793085
228	0,75	-6.139435	-2.630962	-168.6048	-8.595209	-11.5768612	-178.603084	158.606516	-174.1302915	163.0793085
228	1,5	-6.139435	-2.630962	-168.6048	-8.595209	-11.5768612	-178.603084	158.606516	-174.1302915	163.0793085
228	2,25	-6.139435	-2.630962	-168.6048	-8.595209	-11.5768612	-178.603084	158.606516	-174.1302915	163.0793085
228	3	-6.139435	-2.630962	-168.6048	-8.595209	-11.5768612	-178.603084	158.606516	-174.1302915	163.0793085
229	0	-6.035398	-2.543714	-166.6003	-8.4495572	-11.31242	-176.3864916	156.8141084	-172.0321552	161.1684418
229	0,75	-6.035398	-2.543714	-166.6003	-8.4495572	-11.31242	-176.3864916	156.8141084	-172.0321552	161.1684418
229	1,5	-6.035398	-2.543714	-166.6003	-8.4495572	-11.31242	-176.3864916	156.8141084	-172.0321552	161.1684418
229	2,25	-6.035398	-2.543714	-166.6003	-8.4495572	-11.31242	-176.3864916	156.8141084	-172.0321552	161.1684418
229	3	-6.035398	-2.543714	-166.6003	-8.4495572	-11.31242	-176.3864916	156.8141084	-172.0321552	161.1684418
230	0	-6.082624	-2.592	-165.1874	-8.5156736	-11.4463488	-175.0785488	155.2962512	-170.6617616	159.7130384
230	0,75	-6.082624	-2.592	-165.1874	-8.5156736	-11.4463488	-175.0785488	155.2962512	-170.6617616	159.7130384
230	1,5	-6.082624	-2.592	-165.1874	-8.5156736	-11.4463488	-175.0785488	155.2962512	-170.6617616	159.7130384
230	2,25	-6.082624	-2.592	-165.1874	-8.5156736	-11.4463488	-175.0785488	155.2962512	-170.6617616	159.7130384
230	3	-6.082624	-2.592	-165.1874	-8.5156736	-11.4463488	-175.0785488	155.2962512	-170.6617616	159.7130384
231	0	-5.892919	-2.478957	-148.1283	-8.2500866	-11.037834	-157.6787598	138.5778402	-153.4319271	142.8246729
231	0,75	-5.892919	-2.478957	-148.1283	-8.2500866	-11.037834	-157.6787598	138.5778402	-153.4319271	142.8246729
231	1,5	-5.892919	-2.478957	-148.1283	-8.2500866	-11.037834	-157.6787598	138.5778402	-153.4319271	142.8246729
231	2,25	-5.892919	-2.478957	-148.1283	-8.2500866	-11.037834	-157.6787598	138.5778402	-153.4319271	142.8246729
231	3	-5.892919	-2.478957	-148.1283	-8.2500866	-11.037834	-157.6787598	138.5778402	-153.4319271	142.8246729
232	0	-5.950741	-2.519479	-146.2189	-8.3310374	-11.1720556	-155.8792682	136.585318	-151.5745669	140.8632331
232	0,75	-5.950741	-2.519479	-146.2189	-8.3310374	-11.1720556	-155.8792682	136.585318	-151.5745669	140.8632331
232	1,5	-5.950741	-2.519479	-146.2189	-8.3310374	-11.1720556	-155.8792682	136.585318	-151.5745669	140.8632331
232	2,25	-5.950741	-2.519479	-146.2189	-8.3310374	-11.1720556	-155.8792682	136.585318	-151.5745669	140.8632331
232	3	-5.950741	-2.519479	-146.2189	-8.3310374	-11.1720556	-155.8792682	136.585318	-151.5745669	140.8632331
233	0	-5.892807	-2.489129	-144.7141	-8.2499296	-11.0539748	-154.2745974	135.1536026	-150.0176263	139.4105737
233	0,75	-5.892807	-2.489129	-144.7141	-8.2499296	-11.0539748	-154.2745974	135.1536026	-150.0176263	139.4105737
233	1,5	-5.892807	-2.489129	-144.7141	-8.2499296	-11.0539748	-154.2745974	135.1536026	-150.0176263	139.4105737
233	2,25	-5.892807	-2.489129	-144.7141	-8.2499296	-11.0539748	-154.2745974	135.1536026	-150.0176263	139.4105737

Lampiran A13

233	3	5.892807	-2.459129	-144.7141	-6.2495258	-11.0559748	-154.2745974	-155.1539226	-150.0176293	139.4105737
234	0	-5.665457	-2.36994	-127.5626	-7.9316398	-10.5904524	-136.7310564	118.3941116	-132.6615113	122.4639957
234	0.75	-5.665457	-2.36994	-127.5626	-7.9316398	-10.5904524	-136.7310884	118.3941116	-132.6615113	122.4639957
234	1.5	-5.665457	-2.36994	-127.5626	-7.9316398	-10.5904524	-136.7310884	118.3941116	-132.6615113	122.4639957
234	2.25	-5.665457	-2.36994	-127.5626	-7.9316398	-10.5904524	-136.7310884	118.3941116	-132.6615113	122.4639957
234	3	-5.665457	-2.36994	-127.5626	-7.9316398	-10.5904524	-136.7310884	118.3941116	-132.6615113	122.4639957
235	0	-5.615073	-2.32964	-125.5374	-7.8611022	-10.4655116	-134.6051276	116.4696724	-130.5909657	120.4838343
235	0.75	-5.615073	-2.32964	-125.5374	-7.8611022	-10.4655116	-134.6051276	116.4696724	-130.5909657	120.4838343
235	1.5	-5.615073	-2.32964	-125.5374	-7.8611022	-10.4655116	-134.6051276	116.4696724	-130.5909657	120.4838343
235	2.25	-5.615073	-2.32964	-125.5374	-7.8611022	-10.4655116	-134.6051276	116.4696724	-130.5909657	120.4838343
235	3	-5.615073	-2.32964	-125.5374	-7.8611022	-10.4655116	-134.6051276	116.4696724	-130.5909657	120.4838343
236	0	-5.721715	-2.430631	-123.9065	-8.0104031	-10.7550576	-133.203189	114.609611	-129.0560435	118.7569565
236	0.75	-5.721715	-2.430631	-123.9065	-8.0104031	-10.7550576	-133.203189	114.609611	-129.0560435	118.7569565
236	1.5	-5.721715	-2.430631	-123.9065	-8.0104031	-10.7550576	-133.203189	114.609611	-129.0560435	118.7569565
236	2.25	-5.721715	-2.430631	-123.9065	-8.0104031	-10.7550576	-133.203189	114.609611	-129.0560435	118.7569565
236	3	-5.721715	-2.430631	-123.9065	-8.0104031	-10.7550576	-133.203189	114.609611	-129.0560435	118.7569565
237	0	-6.430034	-2.680834	-106.9027	-9.0020475	-12.0053752	-117.2995748	96.5058252	-112.6897306	101.1156694
237	0.83	-6.430034	-2.680834	-106.9027	-9.0020475	-12.0053752	-117.2995748	96.5058252	-112.6897306	101.1156694
237	1.67	-6.430034	-2.680834	-106.9027	-9.0020475	-12.0053752	-117.2995748	96.5058252	-112.6897306	101.1156694
237	2.50	-6.430034	-2.680834	-106.9027	-9.0020475	-12.0053752	-117.2995748	96.5058252	-112.6897306	101.1156694
237	3.33	-6.430034	-2.680834	-106.9027	-9.0020475	-12.0053752	-117.2995748	96.5058252	-112.6897306	101.1156694
238	0	-6.337039	-2.599906	-104.9375	-8.8718546	-11.7642964	-115.1418528	94.7331472	-110.6408351	99.2341649
238	0.83	-6.337039	-2.599906	-104.9375	-8.8718546	-11.7642964	-115.1418528	94.7331472	-110.6408351	99.2341649
238	1.67	-6.337039	-2.599906	-104.9375	-8.8718546	-11.7642964	-115.1418528	94.7331472	-110.6408351	99.2341649
238	2.50	-6.337039	-2.599906	-104.9375	-8.8718546	-11.7642964	-115.1418528	94.7331472	-110.6408351	99.2341649
238	3.33	-6.337039	-2.599906	-104.9375	-8.8718546	-11.7642964	-115.1418528	94.7331472	-110.6408351	99.2341649
239	0	-6.427083	-2.68011	-103.333	-8.9979752	-12.0006756	-113.7255096	92.9403904	-109.1173747	97.5486253
239	0.83	-6.427083	-2.68011	-103.333	-8.9979752	-12.0006756	-113.7255096	92.9403904	-109.1173747	97.5486253
239	1.67	-6.427083	-2.68011	-103.333	-8.9979752	-12.0006756	-113.7255096	92.9403904	-109.1173747	97.5486253
239	2.50	-6.427083	-2.68011	-103.333	-8.9979752	-12.0006756	-113.7255096	92.9403904	-109.1173747	97.5486253
239	3.33	-6.427083	-2.68011	-103.333	-8.9979752	-12.0006756	-113.7255096	92.9403904	-109.1173747	97.5486253
240	0	-5.697229	-2.384279	-86.29	-7.9761206	-10.6515212	-95.5109538	77.0690462	-91.4175061	81.1624939
240	0.75	-5.697229	-2.384279	-86.29	-7.9761206	-10.6515212	-95.5109538	77.0690462	-91.4175061	81.1624939
240	1.5	-5.697229	-2.384279	-86.29	-7.9761206	-10.6515212	-95.5109538	77.0690462	-91.4175061	81.1624939
240	2.25	-5.697229	-2.384279	-86.29	-7.9761206	-10.6515212	-95.5109538	77.0690462	-91.4175061	81.1624939
240	3	-5.697229	-2.384279	-86.29	-7.9761206	-10.6515212	-95.5109538	77.0690462	-91.4175061	81.1624939
241	0	-5.588037	-2.282965	-84.31123	-7.8232516	-10.3583884	-93.2998394	75.326206	-89.3404633	79.2819967
241	0.75	-5.588037	-2.282965	-84.31123	-7.8232516	-10.3583884	-93.2998394	75.326206	-89.3404633	79.2819967
241	1.5	-5.588037	-2.282965	-84.31123	-7.8232516	-10.3583884	-93.2998394	75.326206	-89.3404633	79.2819967

Lampiran A13

241	0,25	-5,586037	-2,282956	-84,31123	10,558366	93,559394	75,322623	-89,3404633	79,2819967
241	3	-5,586037	-2,282956	-84,31123	10,558366	93,559394	75,322623	-89,3404633	79,2819967
242	0	-5,635837	-2,322935	-82,73946	-10,4797004	-91,8253994	73,6535206	-87,8117133	77,6672057
242	0,75	-5,635837	-2,322935	-82,73946	-10,4797004	-91,8253994	73,6535206	-87,8117133	77,6672057
242	1,5	-5,635837	-2,322935	-82,73946	-10,4797004	-91,8253994	73,6535206	-87,8117133	77,6672057
242	2,25	-5,635837	-2,322935	-82,73946	-10,4797004	-91,8253994	73,6535206	-87,8117133	77,6672057
242	3	-5,635837	-2,322935	-82,73946	-10,4797004	-91,8253994	73,6535206	-87,8117133	77,6672057
243	0	-5,8412	-2,396087	-65,71397	-8,17755	-75,119497	56,308443	-70,97105	60,45669
243	0,75	-5,8412	-2,396087	-65,71397	-8,17755	-75,119497	56,308443	-70,97105	60,45669
243	1,5	-5,8412	-2,396087	-65,71397	-8,17755	-75,119497	56,308443	-70,97105	60,45669
243	2,25	-5,8412	-2,396087	-65,71397	-8,17755	-75,119497	56,308443	-70,97105	60,45669
243	3	-5,8412	-2,396087	-65,71397	-8,17755	-75,119497	56,308443	-70,97105	60,45669
244	0	-5,896515	-2,426182	-63,746	-8,25514	-73,248	54,244	69,0529635	58,1301355
244	0,75	-5,896515	-2,426182	-63,746	-8,25514	-73,248	54,244	69,0529635	58,1301355
244	1,5	-5,896515	-2,426182	-63,746	-8,25514	-73,248	54,244	69,0529635	58,1301355
244	2,25	-5,896515	-2,426182	-63,746	-8,25514	-73,248	54,244	69,0529635	58,1301355
244	3	-5,896515	-2,426182	-63,746	-8,25514	-73,248	54,244	69,0529635	58,1301355
245	0	-5,836112	-2,385411	-62,19742	-10,819992	-71,5861954	52,8086746	-67,4499208	56,9449192
245	0,75	-5,836112	-2,385411	-62,19742	-10,819992	-71,5861954	52,8086746	-67,4499208	56,9449192
245	1,5	-5,836112	-2,385411	-62,19742	-10,819992	-71,5861954	52,8086746	-67,4499208	56,9449192
245	2,25	-5,836112	-2,385411	-62,19742	-10,819992	-71,5861954	52,8086746	-67,4499208	56,9449192
245	3	-5,836112	-2,385411	-62,19742	-10,819992	-71,5861954	52,8086746	-67,4499208	56,9449192
246	0	-6,003796	-2,452703	-45,07019	-8,4053144	-54,7274482	35,4129318	-50,4736064	39,6667736
246	0,75	-6,003796	-2,452703	-45,07019	-8,4053144	-54,7274482	35,4129318	-50,4736064	39,6667736
246	1,5	-6,003796	-2,452703	-45,07019	-8,4053144	-54,7274482	35,4129318	-50,4736064	39,6667736
246	2,25	-6,003796	-2,452703	-45,07019	-8,4053144	-54,7274482	35,4129318	-50,4736064	39,6667736
246	3	-6,003796	-2,452703	-45,07019	-8,4053144	-54,7274482	35,4129318	-50,4736064	39,6667736
247	0	-5,952978	-2,403165	-42,9123	-10,9886376	-52,4590366	33,3655614	-48,2699802	37,5546198
247	0,75	-5,952978	-2,403165	-42,9123	-10,9886376	-52,4590366	33,3655614	-48,2699802	37,5546198
247	1,5	-5,952978	-2,403165	-42,9123	-10,9886376	-52,4590366	33,3655614	-48,2699802	37,5546198
247	2,25	-5,952978	-2,403165	-42,9123	-10,9886376	-52,4590366	33,3655614	-48,2699802	37,5546198
247	3	-5,952978	-2,403165	-42,9123	-10,9886376	-52,4590366	33,3655614	-48,2699802	37,5546198
248	0	-6,052192	-2,488467	-41,08799	-11,2441776	-50,8390874	31,3368926	-46,5349628	35,6410172
248	0,75	-6,052192	-2,488467	-41,08799	-11,2441776	-50,8390874	31,3368926	-46,5349628	35,6410172
248	1,5	-6,052192	-2,488467	-41,08799	-11,2441776	-50,8390874	31,3368926	-46,5349628	35,6410172
248	2,25	-6,052192	-2,488467	-41,08799	-11,2441776	-50,8390874	31,3368926	-46,5349628	35,6410172
248	3	-6,052192	-2,488467	-41,08799	-11,2441776	-50,8390874	31,3368926	-46,5349628	35,6410172
249	0	-6,073674	-2,496455	-23,5085	-11,2827368	-33,2933638	13,7236362	-28,9748066	18,0421934
249	0,75	-6,073674	-2,496455	-23,5085	-11,2827368	-33,2933638	13,7236362	-28,9748066	18,0421934

249	1,5	-6,073674	-2,456455	-23,50355	9,5041436	-11,2827368	-33,2933638	13,7831932	25,745008	15,4421834
249	2,25	-6,073674	-2,456455	-23,50355	-8,5031430	-11,2827368	-33,2933638	13,7831932	25,745008	15,4421834
249	3	-6,073674	-2,456455	-23,50355	-8,5031436	-11,2827368	-33,2933638	13,7831932	25,745008	15,4421834
250	0	-5,956356	-2,382231	-21,44088	-8,3388984	-10,9591968	-30,9707382	11,9116218	-26,5016004	15,0801596
250	0,75	-5,956356	-2,382231	-21,44088	-8,3388984	-10,9591968	-30,9707382	11,9116218	-26,5016004	15,0801596
250	1,5	-5,956356	-2,382231	-21,44088	-8,3388984	-10,9591968	-30,9707382	11,9116218	-26,5016004	15,0801596
250	2,25	-5,956356	-2,382231	-21,44088	-8,3388984	-10,9591968	-30,9707382	11,9116218	-26,5016004	15,0801596
250	3	-5,956356	-2,382231	-21,44088	-8,3388984	-10,9591968	-30,9707382	11,9116218	-26,5016004	15,0801596
251	0	-5,963941	-2,394843	-19,88036	-8,3495174	-10,988478	-29,4319522	10,3266078	-26,2479268	14,5128331
251	0,75	-5,963941	-2,394843	-19,88036	-8,3495174	-10,988478	-29,4319522	10,3266078	-26,2479268	14,5128331
251	1,5	-5,963941	-2,394843	-19,88036	-8,3495174	-10,988478	-29,4319522	10,3266078	-26,2479268	14,5128331
251	2,25	-5,963941	-2,394843	-19,88036	-8,3495174	-10,988478	-29,4319522	10,3266078	-26,2479268	14,5128331
251	3	-5,963941	-2,394843	-19,88036	-8,3495174	-10,988478	-29,4319522	10,3266078	-26,2479268	14,5128331
252	0	-5,850332	-2,07872	-2,704565	-8,1904648	-10,3463504	-11,8038834	-6,3945534	7,9585336	-2,5607338
252	0,75	-5,850332	-2,07872	-2,704565	-8,1904648	-10,3463504	-11,8038834	-6,3945534	7,9585336	-2,5607338
252	1,5	-5,850332	-2,07872	-2,704565	-8,1904648	-10,3463504	-11,8038834	-6,3945534	7,9585336	-2,5607338
252	2,25	-5,850332	-2,07872	-2,704565	-8,1904648	-10,3463504	-11,8038834	-6,3945534	7,9585336	-2,5607338
252	3	-5,850332	-2,07872	-2,704565	-8,1904648	-10,3463504	-11,8038834	-6,3945534	7,9585336	-2,5607338
253	0	-5,542473	-1,855344	-0,1998502	-7,7594622	-9,619518	-8,7061618	-6,3064614	-5,1860759	-4,7883755
253	0,75	-5,542473	-1,855344	-0,1998502	-7,7594622	-9,619518	-8,7061618	-6,3064614	-5,1860759	-4,7883755
253	1,5	-5,542473	-1,855344	-0,1998502	-7,7594622	-9,619518	-8,7061618	-6,3064614	-5,1860759	-4,7883755
253	2,25	-5,542473	-1,855344	-0,1998502	-7,7594622	-9,619518	-8,7061618	-6,3064614	-5,1860759	-4,7883755
253	3	-5,542473	-1,855344	-0,1998502	-7,7594622	-9,619518	-8,7061618	-6,3064614	-5,1860759	-4,7883755
254	0	-5,448115	-1,769754	1,084789	-7,627361	-9,3693444	-7,222703	-9,392281	-5,8165145	-5,9880925
254	0,75	-5,448115	-1,769754	1,084789	-7,627361	-9,3693444	-7,222703	-9,392281	-5,8165145	-5,9880925
254	1,5	-5,448115	-1,769754	1,084789	-7,627361	-9,3693444	-7,222703	-9,392281	-5,8165145	-5,9880925
254	2,25	-5,448115	-1,769754	1,084789	-7,627361	-9,3693444	-7,222703	-9,392281	-5,8165145	-5,9880925
254	3	-5,448115	-1,769754	1,084789	-7,627361	-9,3693444	-7,222703	-9,392281	-5,8165145	-5,9880925
255	0	-5,974744	-2,288206	13,41288	-8,3646416	-10,8308224	3,9549812	-22,8707768	8,0355104	-18,7901496
255	0,3	-5,974744	-2,288206	13,41288	-8,3646416	-10,8308224	3,9549812	-22,8707768	8,0355104	-18,7901496
255	1,8	-5,974744	-2,288206	13,41288	-8,3646416	-10,8308224	3,9549812	-22,8707768	8,0355104	-18,7901496
255	2,7	-5,974744	-2,288206	13,41288	-8,3646416	-10,8308224	3,9549812	-22,8707768	8,0355104	-18,7901496
255	3,6	-5,974744	-2,288206	13,41288	-8,3646416	-10,8308224	3,9549812	-22,8707768	8,0355104	-18,7901496
256	0	-5,990353	-2,289346	9,741438	-8,3864942	-10,8513772	0,2636684	-19,2192076	4,3501203	-15,1327557
256	0,9	-5,990353	-2,289346	9,741438	-8,3864942	-10,8513772	0,2636684	-19,2192076	4,3501203	-15,1327557
256	1,8	-5,990353	-2,289346	9,741438	-8,3864942	-10,8513772	0,2636684	-19,2192076	4,3501203	-15,1327557
256	2,7	-5,990353	-2,289346	9,741438	-8,3864942	-10,8513772	0,2636684	-19,2192076	4,3501203	-15,1327557
256	3,6	-5,990353	-2,289346	9,741438	-8,3864942	-10,8513772	0,2636684	-19,2192076	4,3501203	-15,1327557
257	0	-6,258684	-2,507933	7,60227	-8,7621576	-1,5251196	-2,4160838	-17,6206238	1,9694544	-13,2350856

Lampiran A13

257	0.75	-6.256684	-2.507933	7.60227	-6.7621576	-11.5231136	-2.4160838	-17.6206239	1.9694544	-13.2350856
257	0.9	-6.256684	-2.507933	7.60227	-8.7621576	-11.5231136	-2.4160838	-17.6206239	1.9694544	-13.2350856
257	1.35	-6.256684	-2.507933	7.60227	-8.7621576	-11.5231136	-2.4160838	-17.6206239	1.9694544	-13.2350856
257	1.8	-6.256684	-2.507933	7.60227	-6.7621576	-11.5231136	-2.4160838	-17.6206239	1.9694544	-13.2350856

AKSIAL BALOK PORTAL AS 2 (ANALISIS 3D)

LABEL	STATION	PD (KN)	PL (KN)	PE (KN)	1.4P _U (KN)	1.2PD+1.6PL (KN)	1.2PD+PL+PE (KN)	1.2PD+PL+PE (KN)	0.9PD-PE (KN)	0.9PD-PE (KN)
258	0	5.985509	4.455132	-224.0735	8.3797126	14.310822	-212.4357572	235.7112428	-218.6865419	229.4604581
258	0.9	5.985509	4.455132	-224.0735	8.3797126	14.310822	-212.4357572	235.7112428	-218.6865419	229.4604581
258	1.8	5.985509	4.455132	-224.0735	8.3797126	14.310822	-212.4357572	235.7112428	-218.6865419	229.4604581
258	2.7	5.985509	4.455132	-224.0735	8.3797126	14.310822	-212.4357572	235.7112428	-218.6865419	229.4604581
258	3.6	5.985509	4.455132	-224.0735	8.3797126	14.310822	-212.4357572	235.7112428	-218.6865419	229.4604581
259	0	6.024351	4.483927	-222.6522	8.4340914	14.4035044	-210.9395518	234.3653482	-217.2302841	228.0741159
259	0.9	6.024351	4.483927	-222.6522	8.4340914	14.4035044	-210.9395518	234.3653482	-217.2302841	228.0741159
259	1.8	6.024351	4.483927	-222.6522	8.4340914	14.4035044	-210.9395518	234.3653482	-217.2302841	228.0741159
259	2.7	6.024351	4.483927	-222.6522	8.4340914	14.4035044	-210.9395518	234.3653482	-217.2302841	228.0741159
259	3.6	6.024351	4.483927	-222.6522	8.4340914	14.4035044	-210.9395518	234.3653482	-217.2302841	228.0741159
260	0	5.545434	3.551555	-197.7715	7.7650076	12.3382088	-187.5642242	207.9787758	-192.7797094	202.7632906
260	0.75	5.545434	3.551555	-197.7715	7.7650076	12.3382088	-187.5642242	207.9787758	-192.7797094	202.7632906
260	1.5	5.545434	3.551555	-197.7715	7.7650076	12.3382088	-187.5642242	207.9787758	-192.7797094	202.7632906
260	2.25	5.545434	3.551555	-197.7715	7.7650076	12.3382088	-187.5642242	207.9787758	-192.7797094	202.7632906
260	3	5.545434	3.551555	-197.7715	7.7650076	12.3382088	-187.5642242	207.9787758	-192.7797094	202.7632906
261	0	5.605957	3.600077	-197.2456	7.8483398	12.4872716	-186.9163746	207.5728254	-192.2002387	202.2909613
261	0.75	5.605957	3.600077	-197.2456	7.8483398	12.4872716	-186.9163746	207.5728254	-192.2002387	202.2909613
261	1.5	5.605957	3.600077	-197.2456	7.8483398	12.4872716	-186.9163746	207.5728254	-192.2002387	202.2909613
261	2.25	5.605957	3.600077	-197.2456	7.8483398	12.4872716	-186.9163746	207.5728254	-192.2002387	202.2909613
261	3	5.605957	3.600077	-197.2456	7.8483398	12.4872716	-186.9163746	207.5728254	-192.2002387	202.2909613
262	0	5.706416	3.677563	-197.125	7.9898924	12.7318	-185.5997378	207.6502622	-191.9892256	202.2607744
262	0.75	5.706416	3.677563	-197.125	7.9898924	12.7318	-185.5997378	207.6502622	-191.9892256	202.2607744
262	1.5	5.706416	3.677563	-197.125	7.9898924	12.7318	-185.5997378	207.6502622	-191.9892256	202.2607744
262	2.25	5.706416	3.677563	-197.125	7.9898924	12.7318	-185.5997378	207.6502622	-191.9892256	202.2607744
262	3	5.706416	3.677563	-197.125	7.9898924	12.7318	-185.5997378	207.6502622	-191.9892256	202.2607744
263	0	5.414944	3.835679	-187.4546	7.5809216	12.6350192	-177.1209882	197.7882118	-182.5811504	192.3280496
263	0.75	5.414944	3.835679	-187.4546	7.5809216	12.6350192	-177.1209882	197.7882118	-182.5811504	192.3280496
263	1.5	5.414944	3.835679	-187.4546	7.5809216	12.6350192	-177.1209882	197.7882118	-182.5811504	192.3280496
263	2.25	5.414944	3.835679	-187.4546	7.5809216	12.6350192	-177.1209882	197.7882118	-182.5811504	192.3280496
263	3	5.414944	3.835679	-187.4546	7.5809216	12.6350192	-177.1209882	197.7882118	-182.5811504	192.3280496
264	0	5.390084	3.799896	-187.6754	7.5461176	12.5479344	-177.4074032	197.9433968	-182.8243244	192.5264756
264	0.75	5.390084	3.799896	-187.6754	7.5461176	12.5479344	-177.4074032	197.9433968	-182.8243244	192.5264756
264	1.5	5.390084	3.799896	-187.6754	7.5461176	12.5479344	-177.4074032	197.9433968	-182.8243244	192.5264756
264	2.25	5.390084	3.799896	-187.6754	7.5461176	12.5479344	-177.4074032	197.9433968	-182.8243244	192.5264756
264	3	5.390084	3.799896	-187.6754	7.5461176	12.5479344	-177.4074032	197.9433968	-182.8243244	192.5264756

Lampiran A14

255	0	5.326491	3.732079	-157.9809	7.4570674	12.3631156	-177.8570318	198.1047682	-169.1570581	192.7747419
255	0.75	5.326491	3.732079	-157.9809	7.4570674	12.3631156	-177.8570318	198.1047682	-169.1570581	192.7747419
255	1.5	5.326491	3.732079	-157.9809	7.4570674	12.3631156	-177.8570318	198.1047682	-169.1570581	192.7747419
255	2.25	5.326491	3.732079	-157.9809	7.4570674	12.3631156	-177.8570318	198.1047682	-169.1570581	192.7747419
255	3	5.326491	3.732079	-157.9809	7.4570674	12.3631156	-177.8570318	198.1047682	-169.1570581	192.7747419
256	0	4.861619	3.320596	-173.4301	6.8052666	11.1468964	-164.2755612	182.5846339	-169.0546429	177.8055571
256	0.75	4.861619	3.320596	-173.4301	6.8052666	11.1468964	-164.2755612	182.5846339	-169.0546429	177.8055571
256	1.5	4.861619	3.320596	-173.4301	6.8052666	11.1468964	-164.2755612	182.5846339	-169.0546429	177.8055571
256	2.25	4.861619	3.320596	-173.4301	6.8052666	11.1468964	-164.2755612	182.5846339	-169.0546429	177.8055571
256	3	4.861619	3.320596	-173.4301	6.8052666	11.1468964	-164.2755612	182.5846339	-169.0546429	177.8055571
267	0	4.887576	3.343376	-173.663	6.8426084	11.2144928	-164.4745328	182.8914672	-169.2541816	178.0518184
267	0.75	4.887576	3.343376	-173.663	6.8426084	11.2144928	-164.4745328	182.8914672	-169.2541816	178.0518184
267	1.5	4.887576	3.343376	-173.663	6.8426084	11.2144928	-164.4745328	182.8914672	-169.2541816	178.0518184
267	2.25	4.887576	3.343376	-173.663	6.8426084	11.2144928	-164.4745328	182.8914672	-169.2541816	178.0518184
267	3	4.887576	3.343376	-173.663	6.8426084	11.2144928	-164.4745328	182.8914672	-169.2541816	178.0518184
268	0	4.903308	3.357987	-173.7468	6.8546312	11.2557488	-164.5068434	182.9907566	-169.3358228	178.1617772
268	0.75	4.903308	3.357987	-173.7468	6.8546312	11.2557488	-164.5068434	182.9907566	-169.3358228	178.1617772
268	1.5	4.903308	3.357987	-173.7468	6.8546312	11.2557488	-164.5068434	182.9907566	-169.3358228	178.1617772
268	2.25	4.903308	3.357987	-173.7468	6.8546312	11.2557488	-164.5068434	182.9907566	-169.3358228	178.1617772
268	3	4.903308	3.357987	-173.7468	6.8546312	11.2557488	-164.5068434	182.9907566	-169.3358228	178.1617772
269	0	6.469376	4.565061	-158.8212	9.0571264	15.0573488	-146.4928878	171.1495122	-152.9987616	164.6436384
269	0.75	6.469376	4.565061	-158.8212	9.0571264	15.0573488	-146.4928878	171.1495122	-152.9987616	164.6436384
269	1.5	6.469376	4.565061	-158.8212	9.0571264	15.0573488	-146.4928878	171.1495122	-152.9987616	164.6436384
269	2.25	6.469376	4.565061	-158.8212	9.0571264	15.0573488	-146.4928878	171.1495122	-152.9987616	164.6436384
269	3	6.469376	4.565061	-158.8212	9.0571264	15.0573488	-146.4928878	171.1495122	-152.9987616	164.6436384
270	0	6.474069	4.572129	-158.815	9.0636966	15.0642892	-146.4739882	171.1560118	-152.9833379	164.6416621
270	0.75	6.474069	4.572129	-158.815	9.0636966	15.0642892	-146.4739882	171.1560118	-152.9833379	164.6416621
270	1.5	6.474069	4.572129	-158.815	9.0636966	15.0642892	-146.4739882	171.1560118	-152.9833379	164.6416621
270	2.25	6.474069	4.572129	-158.815	9.0636966	15.0642892	-146.4739882	171.1560118	-152.9833379	164.6416621
270	3	6.474069	4.572129	-158.815	9.0636966	15.0642892	-146.4739882	171.1560118	-152.9833379	164.6416621
271	0	6.455723	4.546944	-158.9236	9.0380122	15.021978	-146.6297884	171.2174116	-153.1134493	164.7337507
271	0.75	6.455723	4.546944	-158.9236	9.0380122	15.021978	-146.6297884	171.2174116	-153.1134493	164.7337507
271	1.5	6.455723	4.546944	-158.9236	9.0380122	15.021978	-146.6297884	171.2174116	-153.1134493	164.7337507
271	2.25	6.455723	4.546944	-158.9236	9.0380122	15.021978	-146.6297884	171.2174116	-153.1134493	164.7337507
271	3	6.455723	4.546944	-158.9236	9.0380122	15.021978	-146.6297884	171.2174116	-153.1134493	164.7337507
272	0	5.606724	3.860411	-144.68	7.8494136	12.9347264	-134.0915202	155.2684798	-139.6339484	149.7260516
272	0.75	5.606724	3.860411	-144.68	7.8494136	12.9347264	-134.0915202	155.2684798	-139.6339484	149.7260516
272	1.5	5.606724	3.860411	-144.68	7.8494136	12.9347264	-134.0915202	155.2684798	-139.6339484	149.7260516
272	2.25	5.606724	3.860411	-144.68	7.8494136	12.9347264	-134.0915202	155.2684798	-139.6339484	149.7260516
272	3	5.606724	3.860411	-144.68	7.8494136	12.9347264	-134.0915202	155.2684798	-139.6339484	149.7260516

272	3	5.606724	3.860411	-144,68	7.824,98	12.8399616	-134,0916212	155,2384791	-139,5033456	149,7283171
273	0	5.584436	3.836649	-144,7333	7.8162104	12.8399616	-134,1933278	155,2712722	-139,5073076	149,7592924
273	0,75	5.584436	3.836649	-144,7333	7.8162104	12.8399616	-134,1933278	155,2712722	-139,5073076	149,7592924
273	1,5	5.584436	3.836649	-144,7333	7.8162104	12.8399616	-134,1933278	155,2712722	-139,5073076	149,7592924
273	2,25	5.584436	3.836649	-144,7333	7.8162104	12.8399616	-134,1933278	155,2712722	-139,5073076	149,7592924
273	3	5.584433	3.836649	-144,7333	7.8182104	12.8399616	-134,1933278	155,2712722	-139,5073076	149,7592924
274	0	5.540355	3.795249	144,8303	7.756497	12.7208244	-134,366625	155,273975	-139,5439805	149,8166195
274	0,75	5.540355	3.795249	-144,8303	7.756497	12.7208244	-134,366625	155,273975	-139,5439805	149,8166195
274	1,5	5.540355	3.795249	-144,8303	7.756497	12.7208244	-134,366625	155,273975	-139,5439805	149,8166195
274	2,25	5.540355	3.795249	-144,8303	7.756497	12.7208244	-134,366625	155,273975	-139,5439805	149,8166195
274	3	5.540355	3.795249	-144,8303	7.756497	12.7208244	-134,366625	155,273975	-139,5439805	149,8166195
275	0	6.469481	4.437603	-130,8583	9.0572734	14.863542	-118,6573198	143,0592802	-125,3357671	136,6603329
275	0,83	6.469481	4.437603	-130,8583	9.0572734	14.863542	-118,6573198	143,0592802	-125,3357671	136,6603329
275	1,67	6.469481	4.437603	-130,8583	9.0572734	14.863542	-118,6573198	143,0592802	-125,3357671	136,6603329
275	2,50	6.469481	4.437603	-130,8583	9.0572734	14.863542	-118,6573198	143,0592802	-125,3357671	136,6603329
275	3,33	6.469481	4.437603	-130,8583	9.0572734	14.863542	-118,6573198	143,0592802	-125,3357671	136,6603329
276	0	6.473025	4.439563	-130,9571	9.052235	14.8709306	-118,749907	143,164293	-125,1313775	136,7828225
276	0,83	6.473025	4.439563	-130,9571	9.052235	14.8709306	-118,749907	143,164293	-125,1313775	136,7828225
276	1,67	6.473025	4.439563	-130,9571	9.052235	14.8709306	-118,749907	143,164293	-125,1313775	136,7828225
276	2,50	6.473025	4.439563	-130,9571	9.052235	14.8709306	-118,749907	143,164293	-125,1313775	136,7828225
276	3,33	6.473025	4.439563	-130,9571	9.052235	14.8709306	-118,749907	143,164293	-125,1313775	136,7828225
277	0	6.469877	4.43643	-131,0315	9.0578278	14.8621404	-118,8312176	143,2317824	-125,2086107	136,8543893
277	0,83	6.469877	4.43643	-131,0315	9.0578278	14.8621404	-118,8312176	143,2317824	-125,2086107	136,8543893
277	1,67	6.469877	4.43643	-131,0315	9.0578278	14.8621404	-118,8312176	143,2317824	-125,2086107	136,8543893
277	2,50	6.469877	4.43643	-131,0315	9.0578278	14.8621404	-118,8312176	143,2317824	-125,2086107	136,8543893
277	3,33	6.469877	4.43643	-131,0315	9.0578278	14.8621404	-118,8312176	143,2317824	-125,2086107	136,8543893
278	0	5.531937	3.773247	-117,5497	7.7447118	12.6755196	-107,1381286	127,9612714	-112,5709567	122,5284433
278	0,75	5.531937	3.773247	-117,5497	7.7447118	12.6755196	-107,1381286	127,9612714	-112,5709567	122,5284433
278	1,5	5.531937	3.773247	-117,5497	7.7447118	12.6755196	-107,1381286	127,9612714	-112,5709567	122,5284433
278	2,25	5.531937	3.773247	-117,5497	7.7447118	12.6755196	-107,1381286	127,9612714	-112,5709567	122,5284433
278	3	5.531937	3.773247	-117,5497	7.7447118	12.6755196	-107,1381286	127,9612714	-112,5709567	122,5284433
279	0	5.576643	3.813663	-117,7452	7.8073002	12.7936324	-107,2395654	128,2508346	-112,7282213	122,7641787
279	0,75	5.576643	3.813663	-117,7452	7.8073002	12.7936324	-107,2395654	128,2508346	-112,7282213	122,7641787
279	1,5	5.576643	3.813663	-117,7452	7.8073002	12.7936324	-107,2395654	128,2508346	-112,7282213	122,7641787
279	2,25	5.576643	3.813663	-117,7452	7.8073002	12.7936324	-107,2395654	128,2508346	-112,7282213	122,7641787
279	3	5.576643	3.813663	-117,7452	7.8073002	12.7936324	-107,2395654	128,2508346	-112,7282213	122,7641787
280	0	5.599443	3.83634	-117,8089	7.8392202	12.8574756	-107,2532284	128,3645716	-112,7694013	122,8463987
280	0,75	5.599443	3.83634	-117,8089	7.8392202	12.8574756	-107,2532284	128,3645716	-112,7694013	122,8463987
280	1,5	5.599443	3.83634	-117,8089	7.8392202	12.8574756	-107,2532284	128,3645716	-112,7694013	122,8463987

Lampiran A14

250	2,25	5.599443	3.83634	-17.8069	7.6392202	12.8574756	-107.2532284	128.3645716	-112.7694013	122.5483987
280	3	5.599443	3.83634	-17.8069	7.6392202	12.8574756	-107.2532284	128.3645716	-112.7694013	122.8483987
281	0	6.439867	4.502007	-104.5125	9.0158138	14.9310516	-92.2826526	116.7423474	-98.7166197	110.3083803
281	0,75	6.439867	4.502007	-104.5125	9.0158138	14.9310516	-92.2826526	116.7423474	-98.7166197	110.3083803
281	1,5	6.439867	4.502007	-104.5125	9.0158138	14.9310516	-92.2826526	116.7423474	-98.7166197	110.3083803
281	2,25	6.439867	4.502007	-104.5125	9.0158138	14.9310516	-92.2826526	116.7423474	-98.7166197	110.3083803
281	3	6.439867	4.502007	-104.5125	9.0158138	14.9310516	-92.2826526	116.7423474	-98.7166197	110.3083803
282	0	6.458924	4.526252	-104.638	9.0424936	14.992712	-92.3610392	116.9149608	-98.8249684	110.4510316
282	0,75	6.458924	4.526252	-104.638	9.0424936	14.992712	-92.3610392	116.9149608	-98.8249684	110.4510316
282	1,5	6.458924	4.526252	-104.638	9.0424936	14.992712	-92.3610392	116.9149608	-98.8249684	110.4510316
282	2,25	6.458924	4.526252	-104.638	9.0424936	14.992712	-92.3610392	116.9149608	-98.8249684	110.4510316
282	3	6.458924	4.526252	-104.638	9.0424936	14.992712	-92.3610392	116.9149608	-98.8249684	110.4510316
283	0	6.454843	4.518165	-104.8751	9.0367802	14.9748756	-92.6111234	117.1390766	-99.0657413	110.6844587
283	0,75	6.454843	4.518165	-104.8751	9.0367802	14.9748756	-92.6111234	117.1390766	-99.0657413	110.6844587
283	1,5	6.454843	4.518165	-104.8751	9.0367802	14.9748756	-92.6111234	117.1390766	-99.0657413	110.6844587
283	2,25	6.454843	4.518165	-104.8751	9.0367802	14.9748756	-92.6111234	117.1390766	-99.0657413	110.6844587
283	3	6.454843	4.518165	-104.8751	9.0367802	14.9748756	-92.6111234	117.1390766	-99.0657413	110.6844587
284	0	4.879197	3.29019	-92.23945	6.8308758	11.1193404	-83.0942236	101.3846764	-87.8481727	96.6307273
284	0,75	4.879197	3.29019	-92.23945	6.8308758	11.1193404	-83.0942236	101.3846764	-87.8481727	96.6307273
284	1,5	4.879197	3.29019	-92.23945	6.8308758	11.1193404	-83.0942236	101.3846764	-87.8481727	96.6307273
284	2,25	4.879197	3.29019	-92.23945	6.8308758	11.1193404	-83.0942236	101.3846764	-87.8481727	96.6307273
284	3	4.879197	3.29019	-92.23945	6.8308758	11.1193404	-83.0942236	101.3846764	-87.8481727	96.6307273
285	0	4.863307	3.27383	-92.31767	6.8086298	11.0740964	-83.2080716	101.4276684	-87.9408937	96.6948463
285	0,75	4.863307	3.27383	-92.31767	6.8086298	11.0740964	-83.2080716	101.4276684	-87.9408937	96.6948463
285	1,5	4.863307	3.27383	-92.31767	6.8086298	11.0740964	-83.2080716	101.4276684	-87.9408937	96.6948463
285	2,25	4.863307	3.27383	-92.31767	6.8086298	11.0740964	-83.2080716	101.4276684	-87.9408937	96.6948463
285	3	4.863307	3.27383	-92.31767	6.8086298	11.0740964	-83.2080716	101.4276684	-87.9408937	96.6948463
286	0	4.837337	3.249369	-92.44942	6.7722718	11.0637948	-83.3952466	101.5035934	-88.0958167	96.8030233
286	0,75	4.837337	3.249369	-92.44942	6.7722718	11.0637948	-83.3952466	101.5035934	-88.0958167	96.8030233
286	1,5	4.837337	3.249369	-92.44942	6.7722718	11.0637948	-83.3952466	101.5035934	-88.0958167	96.8030233
286	2,25	4.837337	3.249369	-92.44942	6.7722718	11.0637948	-83.3952466	101.5035934	-88.0958167	96.8030233
286	3	4.837337	3.249369	-92.44942	6.7722718	11.0637948	-83.3952466	101.5035934	-88.0958167	96.8030233
287	0	5.291566	3.632704	-80.44564	7.4081924	12.1622056	-70.4630568	90.4282232	-75.6832306	85.2080494
287	0,75	5.291566	3.632704	-80.44564	7.4081924	12.1622056	-70.4630568	90.4282232	-75.6832306	85.2080494
287	1,5	5.291566	3.632704	-80.44564	7.4081924	12.1622056	-70.4630568	90.4282232	-75.6832306	85.2080494
287	2,25	5.291566	3.632704	-80.44564	7.4081924	12.1622056	-70.4630568	90.4282232	-75.6832306	85.2080494
287	3	5.291566	3.632704	-80.44564	7.4081924	12.1622056	-70.4630568	90.4282232	-75.6832306	85.2080494
288	0	5.355913	3.699208	-80.87959	7.4982782	12.3456284	-70.7532864	91.0058936	-76.0592683	85.6999117
288	0,75	5.355913	3.699208	-80.87959	7.4982782	12.3456284	-70.7532864	91.0058936	-76.0592683	85.6999117

Lampiran A14

286	1,5	5.355913	3.699208	-80.87959	7.4982752	12.3458284	-70.7532864	91.0555335	-75.0592663	85.6999117
288	2,25	5.355913	3.699208	-80.87959	7.4982752	12.3458284	-70.7532864	91.0555335	-76.0592683	85.6999117
288	3	5.355913	3.699208	-80.87959	7.4982782	12.3458284	-70.7532864	91.0555335	-76.0592683	85.6999117
289	0	5.381804	3.733885	-81.18613	7.5345256	12.4323806	-70.9940802	91.3781795	-76.3425064	86.0297536
289	0,75	5.381804	3.733885	-81.18613	7.5345256	12.4323806	-70.9940802	91.3781795	-76.3425064	86.0297536
289	1,5	5.381804	3.733885	-81.18613	7.5345256	12.4323806	-70.9940802	91.3781795	-76.3425051	86.0297536
289	2,25	5.381804	3.733885	-81.18613	7.5345256	12.4323308	-70.9940802	91.3781795	-76.3425064	86.0297536
289	3	5.381804	3.733885	-81.18613	7.5345256	12.4323806	-70.9940802	91.3781795	-76.3425064	86.0297536
290	0	5.629438	3.585631	-68.22845	7.8812132	12.4923352	-57.8874934	76.5594056	-63.1619558	73.2949442
290	0,75	5.629438	3.585631	-68.22845	7.8812132	12.4923352	-57.8874934	76.5594056	-63.1619558	73.2949442
290	1,5	5.629438	3.585631	-68.22845	7.8812132	12.4923352	-57.8874934	76.5594056	-63.1619558	73.2949442
290	2,25	5.629438	3.585631	-68.22845	7.8812132	12.4923352	-57.8874934	76.5594056	-63.1619558	73.2949442
290	3	5.629438	3.585631	-68.22845	7.8812132	12.4923352	-57.8874934	76.5594056	-63.1619558	73.2949442
291	0	5.52016	3.508027	-66.73331	7.728224	12.2370352	-56.601091	76.555529	-61.765166	71.701454
291	0,75	5.52016	3.508027	-66.73331	7.728224	12.2370352	-56.601091	76.555529	-61.765166	71.701454
291	1,5	5.52016	3.508027	-66.73331	7.728224	12.2370352	-56.601091	76.555529	-61.765166	71.701454
291	2,25	5.52016	3.508027	-66.73331	7.728224	12.2370352	-56.601091	76.555529	-61.765166	71.701454
291	3	5.52016	3.508027	-66.73331	7.728224	12.2370352	-56.601091	76.555529	-61.765166	71.701454
292	0	5.449663	3.459337	-64.64968	7.6295282	12.0745348	-54.6507474	74.6466126	-59.7449833	69.5543767
292	0,75	5.449663	3.459337	-64.64968	7.6295282	12.0745348	-54.6507474	74.6466126	-59.7449833	69.5543767
292	1,5	5.449663	3.459337	-64.64968	7.6295282	12.0745348	-54.6507474	74.6466126	-59.7449833	69.5543767
292	2,25	5.449663	3.459337	-64.64968	7.6295282	12.0745348	-54.6507474	74.6466126	-59.7449833	69.5543767
292	3	5.449663	3.459337	-64.64968	7.6295282	12.0745348	-54.6507474	74.6466126	-59.7449833	69.5543767
293	0	5.982598	4.131358	-52.68778	8.3756372	13.7892904	-41.3773044	63.9982556	-47.3034418	58.0721182
293	0,9	5.982598	4.131358	-52.68778	8.3756372	13.7892904	-41.3773044	63.9982556	-47.3034418	58.0721182
293	1,8	5.982598	4.131358	-52.68778	8.3756372	13.7892904	-41.3773044	63.9982556	-47.3034418	58.0721182
293	2,7	5.982598	4.131358	-52.68778	8.3756372	13.7892904	-41.3773044	63.9982556	-47.3034418	58.0721182
293	3,6	5.982598	4.131358	-52.68778	8.3756372	13.7892904	-41.3773044	63.9982556	-47.3034418	58.0721182
294	0	5.935406	4.100428	-50.39716	8.3095684	13.683172	-39.1742448	61.6200752	-45.0552946	55.7390254
294	0,9	5.935406	4.100428	-50.39716	8.3095684	13.683172	-39.1742448	61.6200752	-45.0552946	55.7390254
294	1,8	5.935406	4.100428	-50.39716	8.3095684	13.683172	-39.1742448	61.6200752	-45.0552946	55.7390254
294	2,7	5.935406	4.100428	-50.39716	8.3095684	13.683172	-39.1742448	61.6200752	-45.0552946	55.7390254
294	3,6	5.935406	4.100428	-50.39716	8.3095684	13.683172	-39.1742448	61.6200752	-45.0552946	55.7390254
295	0	-0.4059778	0.4763156	-255.2221	-0.56836892	0.2749316	-255.2329578	255.2112422	-255.58748	254.85672
295	0,9	-0.4059778	0.4763156	-255.2221	-0.56836892	0.2749316	-255.2329578	255.2112422	-255.58748	254.85672
295	1,8	-0.4059778	0.4763156	-255.2221	-0.56836892	0.2749316	-255.2329578	255.2112422	-255.58748	254.85672
295	2,7	-0.4059778	0.4763156	-255.2221	-0.56836892	0.2749316	-255.2329578	255.2112422	-255.58748	254.85672
295	3,6	-0.4059778	0.4763156	-255.2221	-0.56836892	0.2749316	-255.2329578	255.2112422	-255.58748	254.85672
296	0	-0.3584789	0.517951	-250.9437	-0.50187046	0.39854692	-250.8559237	251.0314763	-251.266331	250.621069

296	0.9	-0.3584789	0.517951	-250.9437	-0.50187046	0.39854692	-250.8559237	251.0314763	-251.266331	250.621069
296	1.8	-0.3584789	0.517951	-250.9437	-0.50187046	0.39854692	-250.8559237	251.0314763	-251.266331	250.621069
296	2.7	-0.3584789	0.517951	-250.9437	-0.50187046	0.39854692	-250.8559237	251.0314763	-251.266331	250.621069
296	3.6	-0.3584789	0.517951	-250.9437	-0.50187046	0.39854692	-250.8559237	251.0314763	-251.266331	250.621069
297	0	-1.64E-02	0.8470476	-227.0733	-0.02296	1.33559616	-226.2459324	227.9006676	-227.08806	227.05854
297	0.75	-1.64E-02	0.8470476	-227.0733	-0.02296	1.33559616	-226.2459324	227.9006676	-227.08806	227.05854
297	1.5	-1.64E-02	0.8470476	-227.0733	-0.02296	1.33559616	-226.2459324	227.9006676	-227.08806	227.05854
297	2.25	-1.64E-02	0.8470476	-227.0733	-0.02296	1.33559616	-226.2459324	227.9006676	-227.08806	227.05854
297	3	-1.64E-02	0.8470476	-227.0733	-0.02296	1.33559616	-226.2459324	227.9006676	-227.08806	227.05854
298	0	-0.23896	0.653298	-228.7439	-0.334544	0.7585248	-228.377354	229.110446	-228.959964	228.528836
298	0.75	-0.23896	0.653298	-228.7439	-0.334544	0.7585248	-228.377354	229.110446	-228.959964	228.528836
298	1.5	-0.23896	0.653298	-228.7439	-0.334544	0.7585248	-228.377354	229.110446	-228.959964	228.528836
298	2.25	-0.23896	0.653298	-228.7439	-0.334544	0.7585248	-228.377354	229.110446	-228.959964	228.528836
298	3	-0.23896	0.653298	-228.7439	-0.334544	0.7585248	-228.377354	229.110446	-228.959964	228.528836
299	0	-0.10308	0.7641429	-228.584	-0.144312	1.05893264	-227.9435531	229.2244469	-228.676772	228.491228
299	0.75	-0.10308	0.7641429	-228.584	-0.144312	1.05893264	-227.9435531	229.2244469	-228.676772	228.491228
299	1.5	-0.10308	0.7641429	-228.584	-0.144312	1.05893264	-227.9435531	229.2244469	-228.676772	228.491228
299	2.25	-0.10308	0.7641429	-228.584	-0.144312	1.05893264	-227.9435531	229.2244469	-228.676772	228.491228
299	3	-0.10308	0.7641429	-228.584	-0.144312	1.05893264	-227.9435531	229.2244469	-228.676772	228.491228
300	0	-0.5783392	0.1487173	-210.0137	-0.80967488	-0.45605936	-210.5589897	209.4684103	-210.5342053	209.4931947
300	0.75	-0.5783392	0.1487173	-210.0137	-0.80967488	-0.45605936	-210.5589897	209.4684103	-210.5342053	209.4931947
300	1.5	-0.5783392	0.1487173	-210.0137	-0.80967488	-0.45605936	-210.5589897	209.4684103	-210.5342053	209.4931947
300	2.25	-0.5783392	0.1487173	-210.0137	-0.80967488	-0.45605936	-210.5589897	209.4684103	-210.5342053	209.4931947
300	3	-0.5783392	0.1487173	-210.0137	-0.80967488	-0.45605936	-210.5589897	209.4684103	-210.5342053	209.4931947
301	0	-0.5631061	0.1526836	-211.4004	-0.78834854	-0.43143356	-211.9234437	210.8773563	-211.9071955	210.8936045
301	0.75	-0.5631061	0.1526836	-211.4004	-0.78834854	-0.43143356	-211.9234437	210.8773563	-211.9071955	210.8936045
301	1.5	-0.5631061	0.1526836	-211.4004	-0.78834854	-0.43143356	-211.9234437	210.8773563	-211.9071955	210.8936045
301	2.25	-0.5631061	0.1526836	-211.4004	-0.78834854	-0.43143356	-211.9234437	210.8773563	-211.9071955	210.8936045
301	3	-0.5631061	0.1526836	-211.4004	-0.78834854	-0.43143356	-211.9234437	210.8773563	-211.9071955	210.8936045
302	0	-0.6045853	0.1095788	-212.9936	-0.84641942	-0.55017628	-213.6095236	212.3776764	-213.5377268	212.4494732
302	0.75	-0.6045853	0.1095788	-212.9936	-0.84641942	-0.55017628	-213.6095236	212.3776764	-213.5377268	212.4494732
302	1.5	-0.6045853	0.1095788	-212.9936	-0.84641942	-0.55017628	-213.6095236	212.3776764	-213.5377268	212.4494732
302	2.25	-0.6045853	0.1095788	-212.9936	-0.84641942	-0.55017628	-213.6095236	212.3776764	-213.5377268	212.4494732
302	3	-0.6045853	0.1095788	-212.9936	-0.84641942	-0.55017628	-213.6095236	212.3776764	-213.5377268	212.4494732
303	0	-0.6474164	7.90E-02	-200.4188	-0.90638296	-0.65049566	-201.1166997	199.7209003	-201.0014748	199.8361252
303	0.75	-0.6474164	7.90E-02	-200.4188	-0.90638296	-0.65049566	-201.1166997	199.7209003	-201.0014748	199.8361252
303	1.5	-0.6474164	7.90E-02	-200.4188	-0.90638296	-0.65049566	-201.1166997	199.7209003	-201.0014748	199.8361252
303	2.25	-0.6474164	7.90E-02	-200.4188	-0.90638296	-0.65049566	-201.1166997	199.7209003	-201.0014748	199.8361252
303	3	-0.6474164	7.90E-02	-200.4188	-0.90638296	-0.65049566	-201.1166997	199.7209003	-201.0014748	199.8361252

304	0	-0.6256552	0.1049772	-202.1742	-0.87591726	-0.58282272	-202.820009	201.528391	-202.7372897	201.6111103
304	0.75	-0.6256552	0.1049772	-202.1742	-0.87591728	-0.58282272	-202.820009	201.528391	-202.7372897	201.6111103
304	1.5	-0.6256552	0.1049772	-202.1742	-0.87591728	-0.58282272	-202.820009	201.528391	-202.7372897	201.6111103
304	2.25	-0.6256552	0.1049772	-202.1742	-0.87591728	-0.58282272	-202.820009	201.528391	-202.7372897	201.6111103
304	3	-0.6256552	0.1049772	-202.1742	-0.87591728	-0.58282272	-202.820009	201.528391	-202.7372897	201.6111103
305	0	-0.6393107	0.1022852	-203.7528	-0.89503498	-0.60351652	-204.4176876	203.0879124	-204.3281796	203.1774204
305	0.75	-0.6393107	0.1022852	-203.7528	-0.89503498	-0.60351652	-204.4176876	203.0879124	-204.3281796	203.1774204
305	1.5	-0.6393107	0.1022852	-203.7528	-0.89503498	-0.60351652	-204.4176876	203.0879124	-204.3281796	203.1774204
305	2.25	-0.6393107	0.1022852	-203.7528	-0.89503498	-0.60351652	-204.4176876	203.0879124	-204.3281796	203.1774204
305	3	-0.6393107	0.1022852	-203.7528	-0.89503498	-0.60351652	-204.4176876	203.0879124	-204.3281796	203.1774204
306	0	-0.1653149	0.4404429	-133.8561	-0.23144086	0.50633076	-183.616035	184.100165	-184.0068834	183.7093166
306	0.75	-0.1653149	0.4404429	-183.8561	-0.23144086	0.50633076	-183.616035	184.100165	-184.0068834	183.7093166
306	1.5	-0.1653149	0.4404429	-183.8561	-0.23144086	0.50633076	-183.616035	184.100165	-184.0068834	183.7093166
306	2.25	-0.1653149	0.4404429	-183.8561	-0.23144086	0.50633076	-183.616035	184.100165	-184.0068834	183.7093166
306	3	-0.1653149	0.4404429	-183.8561	-0.23144086	0.50633076	-183.616035	184.100165	-184.0068834	183.7093166
307	0	-0.209167	0.4032327	-182.198	-0.2928338	0.39417192	-182.0457677	182.3502323	-182.3862503	182.0097497
307	0.75	-0.209167	0.4032327	-182.198	-0.2928338	0.39417192	-182.0457677	182.3502323	-182.3862503	182.0097497
307	1.5	-0.209167	0.4032327	-182.198	-0.2928338	0.39417192	-182.0457677	182.3502323	-182.3862503	182.0097497
307	2.25	-0.209167	0.4032327	-182.198	-0.2928338	0.39417192	-182.0457677	182.3502323	-182.3862503	182.0097497
307	3	-0.209167	0.4032327	-182.198	-0.2928338	0.39417192	-182.0457677	182.3502323	-182.3862503	182.0097497
308	0	-0.150587	0.4523327	-181.0311	-0.2108218	0.54302792	-180.7594717	181.3027283	-181.1666283	180.8955717
308	0.75	-0.150587	0.4523327	-181.0311	-0.2108218	0.54302792	-180.7594717	181.3027283	-181.1666283	180.8955717
308	1.5	-0.150587	0.4523327	-181.0311	-0.2108218	0.54302792	-180.7594717	181.3027283	-181.1666283	180.8955717
308	2.25	-0.150587	0.4523327	-181.0311	-0.2108218	0.54302792	-180.7594717	181.3027283	-181.1666283	180.8955717
308	3	-0.150587	0.4523327	-181.0311	-0.2108218	0.54302792	-180.7594717	181.3027283	-181.1666283	180.8955717
309	0	-0.60997	4.96E-02	-162.0585	-0.853958	-0.552604	-162.740864	161.376136	-162.607473	161.509527
309	0.75	-0.60997	4.96E-02	-162.0585	-0.853958	-0.552604	-162.740864	161.376136	-162.607473	161.509527
309	1.5	-0.60997	4.96E-02	-162.0585	-0.853958	-0.552604	-162.740864	161.376136	-162.607473	161.509527
309	2.25	-0.60997	4.96E-02	-162.0585	-0.853958	-0.552604	-162.740864	161.376136	-162.607473	161.509527
309	3	-0.60997	4.96E-02	-162.0585	-0.853958	-0.552604	-162.740864	161.376136	-162.607473	161.509527
310	0	-0.6161782	4.58E-02	-159.6001	-0.86264948	-0.6613384	-160.2937138	158.9064862	-160.1546604	159.0455396
310	0.75	-0.6161782	4.58E-02	-159.6001	-0.86264948	-0.66613384	-160.2937138	158.9064862	-160.1546604	159.0455396
310	1.5	-0.6161782	4.58E-02	-159.6001	-0.86264948	-0.66613384	-160.2937138	158.9064862	-160.1546604	159.0455396
310	2.25	-0.6161782	4.58E-02	-159.6001	-0.86264948	-0.66613384	-160.2937138	158.9064862	-160.1546604	159.0455396
310	3	-0.6161782	4.58E-02	-159.6001	-0.86264948	-0.66613384	-160.2937138	158.9064862	-160.1546604	159.0455396
311	0	-0.6144135	4.78E-02	-157.0759	-0.8601789	-0.6606162	-157.7653962	156.3864038	-157.6288722	156.5229279
311	0.75	-0.6144135	4.78E-02	-157.0759	-0.8601789	-0.6606162	-157.7653962	156.3864038	-157.6288722	156.5229279
311	1.5	-0.6144135	4.78E-02	-157.0759	-0.8601789	-0.6606162	-157.7653962	156.3864038	-157.6288722	156.5229279
311	2.25	-0.6144135	4.78E-02	-157.0759	-0.8601789	-0.6606162	-157.7653962	156.3864038	-157.6288722	156.5229279

Lampiran A14

311	3	-0.6144135	4.78E-02	-157.0759	-0.8631769	-0.5606162	-157.7653962	156.3564038	-157.6268722	155.5229278
312	0	-0.66422566	4.34E-02	-139.822	-0.93000152	-0.72770416	-140.5757442	139.0582558	-140.4198581	139.2241419
312	0.83	-0.66422566	4.34E-02	-139.822	-0.93000152	-0.72770416	-140.5757442	139.0682558	-140.4198581	139.2241419
312	1.67	-0.66422566	4.34E-02	-139.822	-0.93000152	-0.72770416	-140.5757442	139.0682558	-140.4198581	139.2241419
312	2.50	-0.66422566	4.34E-02	-139.822	-0.93000152	-0.72770416	-140.5757442	139.0682558	-140.4198581	139.2241419
312	3.33	-0.66422566	4.34E-02	-139.822	-0.93000152	-0.72770416	-140.5757442	139.0682558	-140.4198581	139.2241419
313	0	-0.6558732	5.13E-02	-137.5797	-0.91822248	-0.70496784	-138.3154478	136.8439522	-138.1699859	136.9894141
313	0.83	-0.6558732	5.13E-02	-137.5797	-0.91822248	-0.70496784	-138.3154478	136.8439522	-138.1699859	136.9894141
313	1.67	-0.6558732	5.13E-02	-137.5797	-0.91822248	-0.70496784	-138.3154478	136.8439522	-138.1699859	136.9894141
313	2.50	-0.6558732	5.13E-02	-137.5797	-0.91822248	-0.70496784	-138.3154478	136.8439522	-138.1699859	136.9894141
313	3.33	-0.6558732	5.13E-02	-137.5797	-0.91822248	-0.70496784	-138.3154478	136.8439522	-138.1699859	136.9894141
314	0	-0.6559734	4.82E-02	-135.3171	-0.9235276	-0.71484808	-136.0508681	134.5733319	-135.9110761	134.7231239
314	0.83	-0.6559734	4.82E-02	-135.3171	-0.9235276	-0.71484808	-136.0508681	134.5733319	-135.9110761	134.7231239
314	1.67	-0.6559734	4.82E-02	-135.3171	-0.9235276	-0.71484808	-136.0508681	134.5733319	-135.9110761	134.7231239
314	2.50	-0.6559734	4.82E-02	-135.3171	-0.9235276	-0.71484808	-136.0508681	134.5733319	-135.9110761	134.7231239
314	3.33	-0.6559734	4.82E-02	-135.3171	-0.9235276	-0.71484808	-136.0508681	134.5733319	-135.9110761	134.7231239
315	0	-0.6040041	2.95E-02	-118.8803	-0.84560574	-0.67760492	-119.5756049	118.1849951	-119.4239037	118.3366963
315	0.75	-0.6040041	2.95E-02	-118.8803	-0.84560574	-0.67760492	-119.5756049	118.1849951	-119.4239037	118.3366963
315	1.5	-0.6040041	2.95E-02	-118.8803	-0.84560574	-0.67760492	-119.5756049	118.1849951	-119.4239037	118.3366963
315	2.25	-0.6040041	2.95E-02	-118.8803	-0.84560574	-0.67760492	-119.5756049	118.1849951	-119.4239037	118.3366963
315	3	-0.6040041	2.95E-02	-118.8803	-0.84560574	-0.67760492	-119.5756049	118.1849951	-119.4239037	118.3366963
316	0	-0.6013039	3.24E-02	-116.7528	-0.84182546	-0.66972468	-117.4419647	116.0636353	-117.2939735	116.2116265
316	0.75	-0.6013039	3.24E-02	-116.7528	-0.84182546	-0.66972468	-117.4419647	116.0636353	-117.2939735	116.2116265
316	1.5	-0.6013039	3.24E-02	-116.7528	-0.84182546	-0.66972468	-117.4419647	116.0636353	-117.2939735	116.2116265
316	2.25	-0.6013039	3.24E-02	-116.7528	-0.84182546	-0.66972468	-117.4419647	116.0636353	-117.2939735	116.2116265
316	3	-0.6013039	3.24E-02	-116.7528	-0.84182546	-0.66972468	-117.4419647	116.0636353	-117.2939735	116.2116265
317	0	-0.5906433	0.0410689	-114.6087	-0.82690062	-0.64306172	-115.2764031	113.9409969	-115.140279	114.077121
317	0.75	-0.5906433	0.0410689	-114.6087	-0.82690062	-0.64306172	-115.2764031	113.9409969	-115.140279	114.077121
317	1.5	-0.5906433	0.0410689	-114.6087	-0.82690062	-0.64306172	-115.2764031	113.9409969	-115.140279	114.077121
317	2.25	-0.5906433	0.0410689	-114.6087	-0.82690062	-0.64306172	-115.2764031	113.9409969	-115.140279	114.077121
317	3	-0.5906433	0.0410689	-114.6087	-0.82690062	-0.64306172	-115.2764031	113.9409969	-115.140279	114.077121
318	0	-0.1241524	0.4210035	-98.20273	-0.17381336	0.52462272	-97.93070938	98.47475062	-98.31446716	98.09099284
318	0.75	-0.1241524	0.4210035	-98.20273	-0.17381336	0.52462272	-97.93070938	98.47475062	-98.31446716	98.09099284
318	1.5	-0.1241524	0.4210035	-98.20273	-0.17381336	0.52462272	-97.93070938	98.47475062	-98.31446716	98.09099284
318	2.25	-0.1241524	0.4210035	-98.20273	-0.17381336	0.52462272	-97.93070938	98.47475062	-98.31446716	98.09099284
318	3	-0.1241524	0.4210035	-98.20273	-0.17381336	0.52462272	-97.93070938	98.47475062	-98.31446716	98.09099284
319	0	-0.1798938	0.3740309	-97.90473	-0.25185132	0.38257688	-97.74657166	98.06288834	-98.06663442	97.74282558
319	0.75	-0.1798938	0.3740309	-97.90473	-0.25185132	0.38257688	-97.74657166	98.06288834	-98.06663442	97.74282558
319	1.5	-0.1798938	0.3740309	-97.90473	-0.25185132	0.38257688	-97.74657166	98.06288834	-98.06663442	97.74282558

319	0	-0.1798936	0.3740309	-87.90473	-0.20165132	0.38367648	87.7463718	88.0003442	88.2663442	88.5323442	88.7983442	89.0643442	89.3303442	89.5963442	89.8623442	90.1283442	90.3943442	90.6603442	90.9263442	91.1923442	91.4583442	91.7243442	91.9903442	92.2563442	92.5223442	92.7883442	93.0543442	93.3203442	93.5863442	93.8523442	94.1183442	94.3843442	94.6503442	94.9163442	95.1823442	95.4483442	95.7143442	95.9803442	96.2463442	96.5123442	96.7783442	97.0443442	97.3103442	97.5763442	97.8423442	98.1083442	98.3743442	98.6403442	98.9063442	99.1723442	99.4383442	99.7043442	99.9703442	100.2363442	100.5023442	100.7683442	101.0343442	101.3003442	101.5663442	101.8323442	102.0983442	102.3643442	102.6303442	102.8963442	103.1623442	103.4283442	103.6943442	103.9603442	104.2263442	104.4923442	104.7583442	105.0243442	105.2903442	105.5563442	105.8223442	106.0883442	106.3543442	106.6203442	106.8863442	107.1523442	107.4183442	107.6843442	107.9503442	108.2163442	108.4823442	108.7483442	109.0143442	109.2803442	109.5463442	109.8123442	110.0783442	110.3443442	110.6103442	110.8763442	111.1423442	111.4083442	111.6743442	111.9403442	112.2063442	112.4723442	112.7383442	113.0043442	113.2703442	113.5363442	113.8023442	114.0683442	114.3343442	114.6003442	114.8663442	115.1323442	115.3983442	115.6643442	115.9303442	116.1963442	116.4623442	116.7283442	116.9943442	117.2603442	117.5263442	117.7923442	118.0583442	118.3243442	118.5903442	118.8563442	119.1223442	119.3883442	119.6543442	119.9203442	120.1863442	120.4523442	120.7183442	120.9843442	121.2503442	121.5163442	121.7823442	122.0483442	122.3143442	122.5803442	122.8463442	123.1123442	123.3783442	123.6443442	123.9103442	124.1763442	124.4423442	124.7083442	124.9743442	125.2403442	125.5063442	125.7723442	126.0383442	126.3043442	126.5703442	126.8363442	127.1023442	127.3683442	127.6343442	127.9003442	128.1663442	128.4323442	128.6983442	128.9643442	129.2303442	129.4963442	129.7623442	130.0283442	130.2943442	130.5603442	130.8263442	131.0923442	131.3583442	131.6243442	131.8903442	132.1563442	132.4223442	132.6883442	132.9543442	133.2203442	133.4863442	133.7523442	134.0183442	134.2843442	134.5503442	134.8163442	135.0823442	135.3483442	135.6143442	135.8803442	136.1463442	136.4123442	136.6783442	136.9443442	137.2103442	137.4763442	137.7423442	138.0083442	138.2743442	138.5403442	138.8063442	139.0723442	139.3383442	139.6043442	139.8703442	140.1363442	140.4023442	140.6683442	140.9343442	141.2003442	141.4663442	141.7323442	141.9983442	142.2643442	142.5303442	142.7963442	143.0623442	143.3283442	143.5943442	143.8603442	144.1263442	144.3923442	144.6583442	144.9243442	145.1903442	145.4563442	145.7223442	145.9883442	146.2543442	146.5203442	146.7863442	147.0523442	147.3183442	147.5843442	147.8503442	148.1163442	148.3823442	148.6483442	148.9143442	149.1803442	149.4463442	149.7123442	149.9783442	150.2443442	150.5103442	150.7763442	151.0423442	151.3083442	151.5743442	151.8403442	152.1063442	152.3723442	152.6383442	152.9043442	153.1703442	153.4363442	153.7023442	153.9683442	154.2343442	154.5003442	154.7663442	155.0323442	155.2983442	155.5643442	155.8303442	156.0963442	156.3623442	156.6283442	156.8943442	157.1603442	157.4263442	157.6923442	157.9583442	158.2243442	158.4903442	158.7563442	159.0223442	159.2883442	159.5543442	159.8203442	160.0863442	160.3523442	160.6183442	160.8843442	161.1503442	161.4163442	161.6823442	161.9483442	162.2143442	162.4803442	162.7463442	163.0123442	163.2783442	163.5443442	163.8103442	164.0763442	164.3423442	164.6083442	164.8743442	165.1403442	165.4063442	165.6723442	165.9383442	166.2043442	166.4703442	166.7363442	167.0023442	167.2683442	167.5343442	167.8003442	168.0663442	168.3323442	168.5983442	168.8643442	169.1303442	169.3963442	169.6623442	169.9283442	170.1943442	170.4603442	170.7263442	170.9923442	171.2583442	171.5243442	171.7903442	172.0563442	172.3223442	172.5883442	172.8543442	173.1203442	173.3863442	173.6523442	173.9183442	174.1843442	174.4503442	174.7163442	174.9823442	175.2483442	175.5143442	175.7803442	176.0463442	176.3123442	176.5783442	176.8443442	177.1103442	177.3763442	177.6423442	177.9083442	178.1743442	178.4403442	178.7063442	178.9723442	179.2383442	179.5043442	179.7703442	180.0363442	180.3023442	180.5683442	180.8343442	181.1003442	181.3663442	181.6323442	181.8983442	182.1643442	182.4303442	182.6963442	182.9623442	183.2283442	183.4943442	183.7603442	184.0263442	184.2923442	184.5583442	184.8243442	185.0903442	185.3563442	185.6223442	185.8883442	186.1543442	186.4203442	186.6863442	186.9523442	187.2183442	187.4843442	187.7503442	188.0163442	188.2823442	188.5483442	188.8143442	189.0803442	189.3463442	189.6123442	189.8783442	190.1443442	190.4103442	190.6763442	190.9423442	191.2083442	191.4743442	191.7403442	192.0063442	192.2723442	192.5383442	192.8043442	193.0703442	193.3363442	193.6023442	193.8683442	194.1343442	194.4003442	194.6663442	194.9323442	195.1983442	195.4643442	195.7303442	195.9963442	196.2623442	196.5283442	196.7943442	197.0603442	197.3263442	197.5923442	197.8583442	198.1243442	198.3903442	198.6563442	198.9223442	199.1883442	199.4543442	199.7203442	199.9863442	200.2523442	200.5183442	200.7843442	201.0503442	201.3163442	201.5823442	201.8483442	202.1143442	202.3803442	202.6463442	202.9123442	203.1783442	203.4443442	203.7103442	203.9763442	204.2423442	204.5083442	204.7743442	205.0403442	205.3063442	205.5723442	205.8383442	206.1043442	206.3703442	206.6363442	206.9023442	207.1683442	207.4343442	207.7003442	207.9663442	208.2323442	208.4983442	208.7643442	209.0303442	209.2963442	209.5623442	209.8283442	210.0943442	210.3603442	210.6263442	210.8923442	211.1583442	211.4243442	211.6903442	211.9563442	212.2223442	212.4883442	212.7543442	213.0203442	213.2863442	213.5523442	213.8183442	214.0843442	214.3503442	214.6163442	214.8823442	215.1483442	215.4143442	215.6803442	215.9463442	216.2123442	216.4783442	216.7443442	217.0103442	217.2763442	217.5423442	217.8083442	218.0743442	218.3403442	218.6063442	218.8723442	219.1383442	219.4043442	219.6703442	219.9363442	220.2023442	220.4683442	220.7343442	221.0003442	221.2663442	221.5323442	221.7983442	222.0643442	222.3303442	222.5963442	222.8623442	223.1283442	223.3943442	223.6603442	223.9263442	224.1923442	224.4583442	224.7243442	224.9903442	225.2563442	225.5223442	225.7883442	226.0543442	226.3203442	226.5863442	226.8523442	227.1183442	227.3843442	227.6503442	227.9163442	228.1823442	228.4483442	228.7143442	228.9803442	229.2463442	229.5123442	229.7783442	230.0443442	230.3103442	230.5763442	230.8423442	231.1083442	231.3743442	231.6403442	231.9063442	232.1723442	232.4383442	232.7043442	232.9703442	233.2363442	233.5023442	233.7683442	234.0343442	234.3003442	234.5663442	234.8323442	235.0983442	235.3643442	235.6303442	235.8963442	236.1623442	236.4283442	236.6943442	236.9603442	237.2263442	237.4923442	237.7583442	238.0243442	238.2903442	238.5563442	238.8223442	239.0883442	239.3543442	239.6203442	239.8863442	240.1523442	240.4183442	240.6843442	240.9503442	241.2163442	241.4823442	241.7483442	242.0143442	242.2803442	242.5463442	242.8123442	243.0783442	243.3443442	243.6103442	243.8763442	244.1423442	244.4083442	244.6743442	244.9403442	245.2063442	245.4723442	245.7383442	246.0043442	246.2703442	246.5363442	246.8023442	247.0683442	247.3343442	247.6003442	247.8663442	248.1323442	248.3983442	248.6643442	248.9303442	249.1963442	249.4623442	249.7283442	249.9943442	250.2603442	250.5263442	250.7923442	251.0583442	251.3243442	251.5903442	251.8563442	252.1223442	252.3883442	252.6543442	252.9203442	253.1863442	253.4523442	253.7183442	253.9843442	254.2503442	254.5163442	254.7823442	255.0483442	255.3143442	255.5803442	255.8463442	256.1123442	256.3783442	256.6443442	256.9103442	257.1763442	257.4423442	257.7083442	257.9743442	258.2403442	258.5063442	258.7723442	259.0383442	259.3043442	259.5703442	259.8363442	260.1023442	260.3683442	260.6343442	260.9003442	261.1663442	261.4323442	261.6983442	261.9643442	262.2303442	262.4963442	262.7623442	263.0283442	263.2943442	263.5603442	263.8263442	264.0923442	264.3583442	264.6243442	264.8903442	265.1563442	265.4223442	265.6883442	265.9543442	266.2203442	266.4863442	266.7523442	267.0183442	267.2843442	267.5503442	267.8163442	268.0823442	268.3483442	268.6143442	268.8803442	269.1463442	269.4123442	269.6783442	269.9443442	270.2103442	270.4763442	270.7423442	271.0083442	271.2743442	271.5403442	271.8063442	272.0723442	272.3383442	272.6043442	272.8703442	273.1363442	273.4023442	273.6683442	273.9343442	274.2003442	274.4663442	274.7323442	274.9983442	275.2643442	275.5303442	275.7963442	276.0623442	276.3283442	276.5943442	276.8603442	277.1263442	277.3923442	277.6583442	277.9243442	278.1903442	278.4563442	278.7223442	278.9883442	279.2543442	279.5203442	279.7863442	280.0523442	280.3183442	280.5843442	280.8503442	281.1163442	281.3823442	281.6483442	281.9143442	282.1803442	282.4463442	282.7123442	282.9783442	283.2443442	283.5103442	283.7763442	284.0423442	284.3083442	284.5743442	284.8403442	285.1063442	285.3723442	285.6383442	285.9043442	286.1703442	286.4363442	286.7023442	286.9683442	287.2343442	287.5003442	287.7663442	288.0323442	288.2983442	288.5643442	288.8303442	289.0963442	289.3623442	289.6283442	289.8943442	290.1603442	290.4263442	290.6923442	290.9583442	291.2243442	291.490
-----	---	------------	-----------	-----------	-------------	------------	------------	------------	------------	------------	------------	------------	------------	------------	------------	------------	------------	------------	------------	------------	------------	------------	------------	------------	------------	------------	------------	------------	------------	------------	------------	------------	------------	------------	------------	------------	------------	------------	------------	------------	------------	------------	------------	------------	------------	------------	------------	------------	------------	------------	------------	------------	------------	-------------	-------------	-------------	-------------	-------------	-------------	-------------	-------------	-------------	-------------	-------------	-------------	-------------	-------------	-------------	-------------	-------------	-------------	-------------	-------------	-------------	-------------	-------------	-------------	-------------	-------------	-------------	-------------	-------------	-------------	-------------	-------------	-------------	-------------	-------------	-------------	-------------	-------------	-------------	-------------	-------------	-------------	-------------	-------------	-------------	-------------	-------------	-------------	-------------	-------------	-------------	-------------	-------------	-------------	-------------	-------------	-------------	-------------	-------------	-------------	-------------	-------------	-------------	-------------	-------------	-------------	-------------	-------------	-------------	-------------	-------------	-------------	-------------	-------------	-------------	-------------	-------------	-------------	-------------	-------------	-------------	-------------	-------------	-------------	-------------	-------------	-------------	-------------	-------------	-------------	-------------	-------------	-------------	-------------	-------------	-------------	-------------	-------------	-------------	-------------	-------------	-------------	-------------	-------------	-------------	-------------	-------------	-------------	-------------	-------------	-------------	-------------	-------------	-------------	-------------	-------------	-------------	-------------	-------------	-------------	-------------	-------------	-------------	-------------	-------------	-------------	-------------	-------------	-------------	-------------	-------------	-------------	-------------	-------------	-------------	-------------	-------------	-------------	-------------	-------------	-------------	-------------	-------------	-------------	-------------	-------------	-------------	-------------	-------------	-------------	-------------	-------------	-------------	-------------	-------------	-------------	-------------	-------------	-------------	-------------	-------------	-------------	-------------	-------------	-------------	-------------	-------------	-------------	-------------	-------------	-------------	-------------	-------------	-------------	-------------	-------------	-------------	-------------	-------------	-------------	-------------	-------------	-------------	-------------	-------------	-------------	-------------	-------------	-------------	-------------	-------------	-------------	-------------	-------------	-------------	-------------	-------------	-------------	-------------	-------------	-------------	-------------	-------------	-------------	-------------	-------------	-------------	-------------	-------------	-------------	-------------	-------------	-------------	-------------	-------------	-------------	-------------	-------------	-------------	-------------	-------------	-------------	-------------	-------------	-------------	-------------	-------------	-------------	-------------	-------------	-------------	-------------	-------------	-------------	-------------	-------------	-------------	-------------	-------------	-------------	-------------	-------------	-------------	-------------	-------------	-------------	-------------	-------------	-------------	-------------	-------------	-------------	-------------	-------------	-------------	-------------	-------------	-------------	-------------	-------------	-------------	-------------	-------------	-------------	-------------	-------------	-------------	-------------	-------------	-------------	-------------	-------------	-------------	-------------	-------------	-------------	-------------	-------------	-------------	-------------	-------------	-------------	-------------	-------------	-------------	-------------	-------------	-------------	-------------	-------------	-------------	-------------	-------------	-------------	-------------	-------------	-------------	-------------	-------------	-------------	-------------	-------------	-------------	-------------	-------------	-------------	-------------	-------------	-------------	-------------	-------------	-------------	-------------	-------------	-------------	-------------	-------------	-------------	-------------	-------------	-------------	-------------	-------------	-------------	-------------	-------------	-------------	-------------	-------------	-------------	-------------	-------------	-------------	-------------	-------------	-------------	-------------	-------------	-------------	-------------	-------------	-------------	-------------	-------------	-------------	-------------	-------------	-------------	-------------	-------------	-------------	-------------	-------------	-------------	-------------	-------------	-------------	-------------	-------------	-------------	-------------	-------------	-------------	-------------	-------------	-------------	-------------	-------------	-------------	-------------	-------------	-------------	-------------	-------------	-------------	-------------	-------------	-------------	-------------	-------------	-------------	-------------	-------------	-------------	-------------	-------------	-------------	-------------	-------------	-------------	-------------	-------------	-------------	-------------	-------------	-------------	-------------	-------------	-------------	-------------	-------------	-------------	-------------	-------------	-------------	-------------	-------------	-------------	-------------	-------------	-------------	-------------	-------------	-------------	-------------	-------------	-------------	-------------	-------------	-------------	-------------	-------------	-------------	-------------	-------------	-------------	-------------	-------------	-------------	-------------	-------------	-------------	-------------	-------------	-------------	-------------	-------------	-------------	-------------	-------------	-------------	-------------	-------------	-------------	-------------	-------------	-------------	-------------	-------------	-------------	-------------	-------------	-------------	-------------	-------------	-------------	-------------	-------------	-------------	-------------	-------------	-------------	-------------	-------------	-------------	-------------	-------------	-------------	-------------	-------------	-------------	-------------	-------------	-------------	-------------	-------------	-------------	-------------	-------------	-------------	-------------	-------------	-------------	-------------	-------------	-------------	-------------	-------------	-------------	-------------	-------------	-------------	-------------	-------------	-------------	-------------	-------------	-------------	-------------	-------------	-------------	-------------	-------------	-------------	-------------	-------------	-------------	-------------	-------------	-------------	-------------	-------------	-------------	-------------	-------------	-------------	-------------	-------------	-------------	-------------	-------------	-------------	-------------	-------------	-------------	-------------	-------------	-------------	-------------	-------------	-------------	-------------	-------------	-------------	-------------	-------------	-------------	-------------	-------------	-------------	-------------	-------------	-------------	-------------	-------------	-------------	-------------	-------------	-------------	-------------	-------------	-------------	-------------	-------------	-------------	-------------	-------------	-------------	-------------	-------------	-------------	-------------	-------------	-------------	-------------	-------------	-------------	-------------	-------------	-------------	-------------	-------------	-------------	-------------	-------------	-------------	-------------	-------------	-------------	-------------	-------------	-------------	-------------	-------------	-------------	-------------	-------------	-------------	-------------	-------------	-------------	-------------	-------------	-------------	-------------	-------------	-------------	-------------	-------------	-------------	-------------	-------------	-------------	-------------	-------------	-------------	-------------	-------------	-------------	-------------	-------------	-------------	-------------	-------------	-------------	-------------	-------------	-------------	-------------	-------------	-------------	-------------	-------------	-------------	-------------	-------------	-------------	-------------	-------------	-------------	-------------	-------------	-------------	-------------	-------------	-------------	-------------	-------------	-------------	-------------	-------------	-------------	-------------	-------------	-------------	-------------	-------------	-------------	-------------	-------------	-------------	-------------	-------------	-------------	-------------	-------------	-------------	-------------	-------------	-------------	-------------	-------------	-------------	-------------	-------------	-------------	-------------	-------------	-------------	-------------	-------------	-------------	-------------	-------------	-------------	-------------	-------------	-------------	-------------	-------------	-------------	-------------	-------------	-------------	-------------	-------------	-------------	-------------	-------------	-------------	-------------	-------------	-------------	-------------	-------------	-------------	-------------	-------------	-------------	-------------	-------------	-------------	-------------	-------------	-------------	-------------	-------------	-------------	-------------	-------------	-------------	-------------	-------------	-------------	-------------	-------------	-------------	-------------	-------------	---------

327	1,5	-0,0744124	0,5558945	57,04164	-0,10417735	0,96013632	-56,47504035	57,5523962	-57,18661116	56,97466554
327	2,25	-0,0744124	0,6558945	-57,04164	-0,10417735	0,96013632	-56,47504035	57,5523962	-57,18661116	56,97466554
327	3	-0,0744124	0,6558945	-57,04164	-0,10417735	0,96013632	-56,47504035	57,5523962	-57,18661116	56,97466554
328	0	-0,2081339	0,5471187	-57,32292	-0,29138746	0,62562924	-57,02556198	57,62027802	-57,51024051	57,13559949
328	0,75	-0,2081339	0,5471187	-57,32292	-0,29138746	0,62562924	-57,02556198	57,62027802	-57,51024051	57,13559949
328	1,5	-0,2081339	0,5471187	-57,32292	-0,29138746	0,62562924	-57,02556198	57,62027802	-57,51024051	57,13559949
328	2,25	-0,2081339	0,5471187	-57,32292	-0,29138746	0,62562924	-57,02556198	57,62027802	-57,51024051	57,13559949
328	3	-0,2081339	0,5471187	-57,32292	-0,29138746	0,62562924	-57,02556198	57,62027802	-57,51024051	57,13559949
329	0	1,35E-02	0,7426872	-58,51743	0,0189	1,20449952	-57,7585428	59,2763172	-58,50528	58,52958
329	0,75	1,35E-02	0,7426872	-58,51743	0,0189	1,20449952	-57,7585428	59,2763172	-58,50528	58,52958
329	1,5	1,35E-02	0,7426872	-58,51743	0,0189	1,20449952	-57,7585428	59,2763172	-58,50528	58,52958
329	2,25	1,35E-02	0,7426872	-58,51743	0,0189	1,20449952	-57,7585428	59,2763172	-58,50528	58,52958
329	3	1,35E-02	0,7426872	-58,51743	0,0189	1,20449952	-57,7585428	59,2763172	-58,50528	58,52958
330	0	-0,1563036	0,3024733	-37,29496	-0,21882504	0,29639296	-37,18005102	37,40986896	-37,43563324	37,15428676
330	0,9	-0,1563036	0,3024733	-37,29496	-0,21882504	0,29639296	-37,18005102	37,40986896	-37,43563324	37,15428676
330	1,8	-0,1563036	0,3024733	-37,29496	-0,21882504	0,29639296	-37,18005102	37,40986896	-37,43563324	37,15428676
330	2,7	-0,1563036	0,3024733	-37,29496	-0,21882504	0,29639296	-37,18005102	37,40986896	-37,43563324	37,15428676
330	3,6	-0,1563036	0,3024733	-37,29496	-0,21882504	0,29639296	-37,18005102	37,40986896	-37,43563324	37,15428676
331	0	-0,1965227	0,2680535	-34,15146	-0,27513176	0,19305836	-34,11923374	34,18368626	-34,32833043	33,97458957
331	0,9	-0,1965227	0,2680535	-34,15146	-0,27513176	0,19305836	-34,11923374	34,18368626	-34,32833043	33,97458957
331	1,8	-0,1965227	0,2680535	-34,15146	-0,27513176	0,19305836	-34,11923374	34,18368626	-34,32833043	33,97458957
331	2,7	-0,1965227	0,2680535	-34,15146	-0,27513176	0,19305836	-34,11923374	34,18368626	-34,32833043	33,97458957
331	3,6	-0,1965227	0,2680535	-34,15146	-0,27513176	0,19305836	-34,11923374	34,18368626	-34,32833043	33,97458957
332	0	-9,419438	-8,021606	-202,2037	-13,1872132	-24,1378952	-221,5286316	182,8787684	-210,6811942	193,7262058
332	0,9	-9,419438	-8,021606	-202,2037	-13,1872132	-24,1378952	-221,5286316	182,8787684	-210,6811942	193,7262058
332	1,8	-9,419438	-8,021606	-202,2037	-13,1872132	-24,1378952	-221,5286316	182,8787684	-210,6811942	193,7262058
332	2,7	-9,419438	-8,021606	-202,2037	-13,1872132	-24,1378952	-221,5286316	182,8787684	-210,6811942	193,7262058
332	3,6	-9,419438	-8,021606	-202,2037	-13,1872132	-24,1378952	-221,5286316	182,8787684	-210,6811942	193,7262058
333	0	-9,480218	-8,042423	-197,1311	-13,2723052	-24,2441384	-216,5497846	177,7124154	-205,6632962	188,5989038
333	0,9	-9,480218	-8,042423	-197,1311	-13,2723052	-24,2441384	-216,5497846	177,7124154	-205,6632962	188,5989038
333	1,8	-9,480218	-8,042423	-197,1311	-13,2723052	-24,2441384	-216,5497846	177,7124154	-205,6632962	188,5989038
333	2,7	-9,480218	-8,042423	-197,1311	-13,2723052	-24,2441384	-216,5497846	177,7124154	-205,6632962	188,5989038
333	3,6	-9,480218	-8,042423	-197,1311	-13,2723052	-24,2441384	-216,5497846	177,7124154	-205,6632962	188,5989038
343	0	-10,951	-8,144927	-179,3276	-15,3314	-26,1730832	-200,613727	158,041473	-189,1835	169,4717
343	0,75	-10,951	-8,144927	-179,3276	-15,3314	-26,1730832	-200,613727	158,041473	-189,1835	169,4717
343	1,5	-10,951	-8,144927	-179,3276	-15,3314	-26,1730832	-200,613727	158,041473	-189,1835	169,4717
343	2,25	-10,951	-8,144927	-179,3276	-15,3314	-26,1730832	-200,613727	158,041473	-189,1835	169,4717
343	3	-10,951	-8,144927	-179,3276	-15,3314	-26,1730832	-200,613727	158,041473	-189,1835	169,4717
345	0	-10,94442	-8,11102	-180,2854	-15,322188	-26,110936	-201,529724	159,041076	-189,135378	170,435422

Lampiran A14

345	0,75	-10,94442	-9,11102	-160,2854	-15,322168	-26,110936	-201,529724	159,041076	-190,135376	-170,436422
345	1,5	-10,94442	-8,11102	-160,2854	-15,322168	-26,110936	-201,529724	159,041076	-190,135376	-170,436422
345	2,25	-10,94442	-8,11102	-160,2854	-15,322168	-26,110936	-201,529724	159,041076	-190,135376	-170,436422
345	3	-10,94442	-8,11102	-160,2854	-15,322168	-26,110936	-201,529724	159,041076	-190,135376	-170,436422
346	0	-10,60983	-7,871068	-161,1407	-14,853762	-25,3255048	-201,743554	160,537836	-190,689547	-171,591653
346	0,75	-10,60983	-7,871068	-161,1407	-14,853762	-25,3255048	-201,743554	160,537836	-190,689547	-171,591653
346	1,5	-10,60983	-7,871068	-161,1407	-14,853762	-25,3255048	-201,743554	160,537836	-190,689547	-171,591653
346	2,25	-10,60983	-7,871068	-161,1407	-14,853762	-25,3255048	-201,743554	160,537836	-190,689547	-171,591653
346	3	-10,60983	-7,871068	-161,1407	-14,853762	-25,3255048	-201,743554	160,537836	-190,689547	-171,591653
347	0	-9,160225	-7,190567	-168,0468	-12,852315	-22,5211772	-186,255637	149,841963	-176,3110025	-159,7865975
347	0,75	-9,160225	-7,190567	-168,0468	-12,852315	-22,5211772	-186,255637	149,841963	-176,3110025	-159,7865975
347	1,5	-9,160225	-7,190567	-168,0468	-12,852315	-22,5211772	-186,255637	149,841963	-176,3110025	-159,7865975
347	2,25	-9,160225	-7,190567	-168,0468	-12,852315	-22,5211772	-186,255637	149,841963	-176,3110025	-159,7865975
347	3	-9,160225	-7,190567	-168,0468	-12,852315	-22,5211772	-186,255637	149,841963	-176,3110025	-159,7865975
348	0	-9,237455	-7,242324	-169,4825	-12,932437	-22,6726544	-187,63977	151,15523	-177,562095	-161,1687905
348	0,75	-9,237455	-7,242324	-169,4825	-12,932437	-22,6726544	-187,63977	151,15523	-177,562095	-161,1687905
348	1,5	-9,237455	-7,242324	-169,4825	-12,932437	-22,6726544	-187,63977	151,15523	-177,562095	-161,1687905
348	2,25	-9,237455	-7,242324	-169,4825	-12,932437	-22,6726544	-187,63977	151,15523	-177,562095	-161,1687905
348	3	-9,237455	-7,242324	-169,4825	-12,932437	-22,6726544	-187,63977	151,15523	-177,562095	-161,1687905
349	0	-9,076404	-7,089724	-170,494	-12,7065656	-22,2352432	-188,4754068	152,5125912	-178,6627636	-162,3252354
349	0,75	-9,076404	-7,089724	-170,494	-12,7065656	-22,2352432	-188,4754068	152,5125912	-178,6627636	-162,3252354
349	1,5	-9,076404	-7,089724	-170,494	-12,7065656	-22,2352432	-188,4754068	152,5125912	-178,6627636	-162,3252354
349	2,25	-9,076404	-7,089724	-170,494	-12,7065656	-22,2352432	-188,4754068	152,5125912	-178,6627636	-162,3252354
349	3	-9,076404	-7,089724	-170,494	-12,7065656	-22,2352432	-188,4754068	152,5125912	-178,6627636	-162,3252354
350	0	-8,676145	-6,658459	-156,9687	-12,146603	-21,0649084	-174,036533	139,898667	-164,772305	-149,1601695
350	0,75	-8,676145	-6,658459	-156,9687	-12,146603	-21,0649084	-174,036533	139,898667	-164,772305	-149,1601695
350	1,5	-8,676145	-6,658459	-156,9687	-12,146603	-21,0649084	-174,036533	139,898667	-164,772305	-149,1601695
350	2,25	-8,676145	-6,658459	-156,9687	-12,146603	-21,0649084	-174,036533	139,898667	-164,772305	-149,1601695
350	3	-8,676145	-6,658459	-156,9687	-12,146603	-21,0649084	-174,036533	139,898667	-164,772305	-149,1601695
351	0	-8,621386	-6,77691	-157,81	-12,3499432	-21,4287216	-175,1725756	140,4474244	-165,7492492	-149,8707508
351	0,75	-8,621386	-6,77691	-157,81	-12,3499432	-21,4287216	-175,1725756	140,4474244	-165,7492492	-149,8707508
351	1,5	-8,621386	-6,77691	-157,81	-12,3499432	-21,4287216	-175,1725756	140,4474244	-165,7492492	-149,8707508
351	2,25	-8,621386	-6,77691	-157,81	-12,3499432	-21,4287216	-175,1725756	140,4474244	-165,7492492	-149,8707508
351	3	-8,621386	-6,77691	-157,81	-12,3499432	-21,4287216	-175,1725756	140,4474244	-165,7492492	-149,8707508
352	0	-8,722329	-6,6853	-156,1141	-12,2112606	-21,1632748	-175,2661948	140,9620052	-166,9641961	-150,2640039
352	0,75	-8,722329	-6,6853	-156,1141	-12,2112606	-21,1632748	-175,2661948	140,9620052	-166,9641961	-150,2640039
352	1,5	-8,722329	-6,6853	-156,1141	-12,2112606	-21,1632748	-175,2661948	140,9620052	-166,9641961	-150,2640039
352	2,25	-8,722329	-6,6853	-156,1141	-12,2112606	-21,1632748	-175,2661948	140,9620052	-166,9641961	-150,2640039
352	3	-8,722329	-6,6853	-156,1141	-12,2112606	-21,1632748	-175,2661948	140,9620052	-166,9641961	-150,2640039

353	C	-10,55519	-8,063764	-143,7232	-14,633266	-25,6162504	-164,501192	122,945208	-153,258871	134,187529
353	0,75	-10,59519	-8,063764	-143,7232	-14,633266	-25,6162504	-164,501192	122,945208	-153,258871	134,187529
353	1,5	-10,59519	-8,063764	-143,7232	-14,633266	-25,6162504	-164,501192	122,945208	-153,258871	134,187529
353	2,25	-10,59519	-8,063764	-143,7232	-14,633266	-25,6162504	-164,501192	122,945208	-153,258871	134,187529
353	3	-10,59519	-8,063764	-143,7232	-14,633266	-25,6162504	-164,501192	122,945208	-153,258871	134,187529
356	0	-10,61765	-8,086387	-144,5046	-14,66471	-25,6793992	-165,332167	123,677033	-154,060485	134,948715
356	0,75	-10,61765	-8,086387	-144,5046	-14,66471	-25,6793992	-165,332167	123,677033	-154,060485	134,948715
356	1,5	-10,61765	-8,086387	-144,5046	-14,66471	-25,6793992	-165,332167	123,677033	-154,060485	134,948715
356	2,25	-10,61765	-8,086387	-144,5046	-14,66471	-25,6793992	-165,332167	123,677033	-154,060485	134,948715
356	3	-10,61765	-8,086387	-144,5046	-14,66471	-25,6793992	-165,332167	123,677033	-154,060485	134,948715
357	0	-10,59386	-8,050933	-144,9243	-14,631404	-25,5941248	-165,667865	124,160735	-154,458774	135,389826
357	0,75	-10,59386	-8,050933	-144,9243	-14,631404	-25,5941248	-165,667865	124,160735	-154,458774	135,389826
357	1,5	-10,59386	-8,050933	-144,9243	-14,631404	-25,5941248	-165,667865	124,160735	-154,458774	135,389826
357	2,25	-10,59386	-8,050933	-144,9243	-14,631404	-25,5941248	-165,667865	124,160735	-154,458774	135,389826
357	3	-10,59386	-8,050933	-144,9243	-14,631404	-25,5941248	-165,667865	124,160735	-154,458774	135,389826
358	0	-9,490608	-7,12468	-130,5499	-13,2668512	-22,7662176	-149,0633096	112,0364904	-139,0914472	122,0083528
358	0,75	-9,490608	-7,12468	-130,5499	-13,2668512	-22,7662176	-149,0633096	112,0364904	-139,0914472	122,0083528
358	1,5	-9,490608	-7,12468	-130,5499	-13,2668512	-22,7662176	-149,0633096	112,0364904	-139,0914472	122,0083528
358	2,25	-9,490608	-7,12468	-130,5499	-13,2668512	-22,7662176	-149,0633096	112,0364904	-139,0914472	122,0083528
358	3	-9,490608	-7,12468	-130,5499	-13,2668512	-22,7662176	-149,0633096	112,0364904	-139,0914472	122,0083528
359	0	-9,5878	-7,202499	-131,3907	-13,42292	-23,0293584	-150,098559	112,682841	-140,01972	122,76168
359	0,75	-9,5878	-7,202499	-131,3907	-13,42292	-23,0293584	-150,098559	112,682841	-140,01972	122,76168
359	1,5	-9,5878	-7,202499	-131,3907	-13,42292	-23,0293584	-150,098559	112,682841	-140,01972	122,76168
359	2,25	-9,5878	-7,202499	-131,3907	-13,42292	-23,0293584	-150,098559	112,682841	-140,01972	122,76168
359	3	-9,5878	-7,202499	-131,3907	-13,42292	-23,0293584	-150,098559	112,682841	-140,01972	122,76168
360	0	-9,439881	-7,068127	-131,8784	-13,2158334	-22,6366604	-150,2743842	113,4824158	-140,3742929	123,3825071
360	0,75	-9,439881	-7,068127	-131,8784	-13,2158334	-22,6366604	-150,2743842	113,4824158	-140,3742929	123,3825071
360	1,5	-9,439881	-7,068127	-131,8784	-13,2158334	-22,6366604	-150,2743842	113,4824158	-140,3742929	123,3825071
360	2,25	-9,439881	-7,068127	-131,8784	-13,2158334	-22,6366604	-150,2743842	113,4824158	-140,3742929	123,3825071
360	3	-9,439881	-7,068127	-131,8784	-13,2158334	-22,6366604	-150,2743842	113,4824158	-140,3742929	123,3825071
361	0	-10,85056	-8,07242	-117,4952	-15,190784	-25,936544	-138,588292	96,42108	-127,260704	107,729696
361	0,63	-10,85056	-8,07242	-117,4952	-15,190784	-25,936544	-138,588292	96,402108	-127,260704	107,729696
361	1,67	-10,85056	-8,07242	-117,4952	-15,190784	-25,936544	-138,588292	96,402108	-127,260704	107,729696
361	2,50	-10,85056	-8,07242	-117,4952	-15,190784	-25,936544	-138,588292	96,402108	-127,260704	107,729696
361	3,33	-10,85056	-8,07242	-117,4952	-15,190784	-25,936544	-138,588292	96,402108	-127,260704	107,729696
362	0	-11,01053	-8,206098	-118,2869	-15,414742	-26,3423928	-139,705634	96,868166	-128,196377	108,377423
362	0,63	-11,01053	-8,206098	-118,2869	-15,414742	-26,3423928	-139,705634	96,868166	-128,196377	108,377423
362	1,67	-11,01053	-8,206098	-118,2869	-15,414742	-26,3423928	-139,705634	96,868166	-128,196377	108,377423
362	2,50	-11,01053	-8,206098	-118,2869	-15,414742	-26,3423928	-139,705634	96,868166	-128,196377	108,377423

362		-11,01053	-6,206098	-116,2869	-13,414742	-25,9356624	-139,72624	56,565166	-128,527976	108,377423
363	0	-10,85242	-6,070474	-116,7608	-15,193368	-25,9356624	-139,894178	57,667422	-128,527976	106,993622
363	0,63	-10,85242	-6,070474	-116,7608	-15,193368	-25,9356624	-139,894178	57,667422	-128,527976	108,993622
363	1,67	-10,85242	-6,070474	-116,7608	-15,193388	-25,9356624	-139,894178	57,667422	-128,527976	108,993622
363	2,50	-10,85242	-6,070474	-118,7608	-15,193399	-25,9356624	-139,894178	57,667422	-128,527976	108,993622
363	3,33	-10,85242	-6,070474	-118,7608	-15,193386	-25,9356624	-139,894178	57,667422	-128,527976	108,993622
364	0	-9,440709	-6,999875	-104,3455	-13,2169926	-22,5286508	-122,6742258	65,0167742	-112,8421381	95,8488619
364	0,75	-9,440709	-6,999875	-104,3455	-13,2169926	-22,5286508	-122,6742258	65,0167742	-112,8421381	95,8488619
364	1,5	-9,440709	-6,999875	-104,3455	-13,2169926	-22,5286508	-122,6742258	65,0167742	-112,8421381	95,8488619
364	2,25	-9,440709	-6,999875	-104,3455	-13,2169926	-22,5286508	-122,6742258	65,0167742	-112,8421381	95,8488619
364	3	-9,440709	-6,999875	-104,3455	-13,2169926	-22,5286508	-122,6742258	65,0167742	-112,8421381	95,8488619
365	0	-9,590155	-7,131961	-105,1527	-13,426217	-22,9193236	-123,792647	66,512553	-113,7636395	96,5215605
365	0,75	-9,590155	-7,131961	-105,1527	-13,426217	-22,9193236	-123,792647	66,512553	-113,7636395	96,5215605
365	1,5	-9,590155	-7,131961	-105,1527	-13,426217	-22,9193236	-123,792647	66,512553	-113,7636395	96,5215605
365	2,25	-9,590155	-7,131961	-105,1527	-13,426217	-22,9193236	-123,792647	66,512553	-113,7636395	96,5215605
365	3	-9,590155	-7,131961	-105,1527	-13,426217	-22,9193236	-123,792647	66,512553	-113,7636395	96,5215605
366	0	-9,49452	-7,051857	-105,6049	-13,292328	-22,6763952	-124,050181	67,159619	-114,149958	97,059832
366	0,75	-9,49452	-7,051857	-105,6049	-13,292328	-22,6763952	-124,050181	67,159619	-114,149958	97,059832
366	1,5	-9,49452	-7,051857	-105,6049	-13,292328	-22,6763952	-124,050181	67,159619	-114,149958	97,059832
366	2,25	-9,49452	-7,051857	-105,6049	-13,292328	-22,6763952	-124,050181	67,159619	-114,149958	97,059832
366	3	-9,49452	-7,051857	-105,6049	-13,292328	-22,6763952	-124,050181	67,159619	-114,149958	97,059832
367	0	-10,59683	-7,910366	-91,00382	-14,835562	-25,3727816	-111,630382	70,377258	-100,540957	81,466673
367	0,75	-10,59683	-7,910366	-91,00382	-14,835562	-25,3727816	-111,630382	70,377258	-100,540957	81,466673
367	1,5	-10,59683	-7,910366	-91,00382	-14,835562	-25,3727816	-111,630382	70,377258	-100,540957	81,466673
367	2,25	-10,59683	-7,910366	-91,00382	-14,835562	-25,3727816	-111,630382	70,377258	-100,540957	81,466673
367	3	-10,59683	-7,910366	-91,00382	-14,835562	-25,3727816	-111,630382	70,377258	-100,540957	81,466673
368	0	-10,62225	-7,943527	-91,85909	-14,87115	-25,4563432	-112,549317	71,168863	-101,419115	82,299065
368	0,75	-10,62225	-7,943527	-91,85909	-14,87115	-25,4563432	-112,549317	71,168863	-101,419115	82,299065
368	1,5	-10,62225	-7,943527	-91,85909	-14,87115	-25,4563432	-112,549317	71,168863	-101,419115	82,299065
368	2,25	-10,62225	-7,943527	-91,85909	-14,87115	-25,4563432	-112,549317	71,168863	-101,419115	82,299065
368	3	-10,62225	-7,943527	-91,85909	-14,87115	-25,4563432	-112,549317	71,168863	-101,419115	82,299065
369	0	-10,60139	-7,918603	-92,33624	-14,841546	-25,3914328	-112,976511	71,699569	-101,877491	82,794989
369	0,75	-10,60139	-7,918603	-92,33624	-14,841546	-25,3914328	-112,976511	71,699569	-101,877491	82,794989
369	1,5	-10,60139	-7,918603	-92,33624	-14,841546	-25,3914328	-112,976511	71,699569	-101,877491	82,794989
369	2,25	-10,60139	-7,918603	-92,33624	-14,841546	-25,3914328	-112,976511	71,699569	-101,877491	82,794989
369	3	-10,60139	-7,918603	-92,33624	-14,841546	-25,3914328	-112,976511	71,699569	-101,877491	82,794989
370	0	-8,727499	-6,473767	-77,6845	-12,2184986	-20,831025	-94,6312658	60,7377342	-85,5392491	69,8297509
370	0,75	-8,727499	-6,473767	-77,6845	-12,2184986	-20,831025	-94,6312658	60,7377342	-85,5392491	69,8297509
370	1,5	-8,727499	-6,473767	-77,6845	-12,2184986	-20,831025	-94,6312658	60,7377342	-85,5392491	69,8297509

Lampiran A14

370	2,25	-8,727499	-6,473767	-77,6645	-12,2184966	-20,831026	-94,6312558	60,7377342	-65,5392491	69,8297599
370	3	-8,727499	-6,473767	-77,6645	-12,2184966	-20,831026	-94,6312558	60,7377342	-65,5392491	69,8297599
371	0	-8,828929	-6,563836	-78,66107	-12,3605006	-21,0968524	-95,8196208	61,5025192	-66,6071061	70,7150339
371	0,75	-8,828929	-6,563836	-78,66107	-12,3605006	-21,0968524	-95,8196208	61,5025192	-66,6071061	70,7150339
371	1,5	-8,828929	-6,563836	-78,66107	-12,3605006	-21,0968524	-95,8196208	61,5025192	-66,6071061	70,7150339
371	2,25	-8,828929	-6,563836	-78,66107	-12,3605006	-21,0968524	-95,8196208	61,5025192	-66,6071061	70,7150339
371	3	-8,828929	-6,563836	-78,66107	-12,3605006	-21,0968524	-95,8196208	61,5025192	-66,6071061	70,7150339
372	0	-8,68713	-6,444354	-79,34759	-12,161982	-20,7355224	-96,2165	62,47868	-67,166007	71,529173
372	0,75	-8,68713	-6,444354	-79,34759	-12,161982	-20,7355224	-96,2165	62,47868	-67,166007	71,529173
372	1,5	-8,68713	-6,444354	-79,34759	-12,161982	-20,7355224	-96,2165	62,47868	-67,166007	71,529173
372	2,25	-8,68713	-6,444354	-79,34759	-12,161982	-20,7355224	-96,2165	62,47868	-67,166007	71,529173
372	3	-8,68713	-6,444354	-79,34759	-12,161982	-20,7355224	-96,2165	62,47868	-67,166007	71,529173
373	0	-9,095833	-6,797606	-64,90175	-12,7341662	-21,7911692	-82,5143556	47,1891444	-73,0879997	56,7155003
373	0,75	-9,095833	-6,797606	-64,90175	-12,7341662	-21,7911692	-82,5143556	47,1891444	-73,0879997	56,7155003
373	1,5	-9,095833	-6,797606	-64,90175	-12,7341662	-21,7911692	-82,5143556	47,1891444	-73,0879997	56,7155003
373	2,25	-9,095833	-6,797606	-64,90175	-12,7341662	-21,7911692	-82,5143556	47,1891444	-73,0879997	56,7155003
373	3	-9,095833	-6,797606	-64,90175	-12,7341662	-21,7911692	-82,5143556	47,1891444	-73,0879997	56,7155003
374	0	-9,260149	-6,947791	-65,83736	-12,9642086	-22,2286444	-83,8973298	47,7773902	-74,1714941	57,5032259
374	0,75	-9,260149	-6,947791	-65,83736	-12,9642086	-22,2286444	-83,8973298	47,7773902	-74,1714941	57,5032259
374	1,5	-9,260149	-6,947791	-65,83736	-12,9642086	-22,2286444	-83,8973298	47,7773902	-74,1714941	57,5032259
374	2,25	-9,260149	-6,947791	-65,83736	-12,9642086	-22,2286444	-83,8973298	47,7773902	-74,1714941	57,5032259
374	3	-9,260149	-6,947791	-65,83736	-12,9642086	-22,2286444	-83,8973298	47,7773902	-74,1714941	57,5032259
375	0	-9,201686	-6,892325	-66,31235	-12,8823604	-22,0697432	-84,2466982	48,3780016	-74,5938674	58,0308326
375	0,75	-9,201686	-6,892325	-66,31235	-12,8823604	-22,0697432	-84,2466982	48,3780016	-74,5938674	58,0308326
375	1,5	-9,201686	-6,892325	-66,31235	-12,8823604	-22,0697432	-84,2466982	48,3780016	-74,5938674	58,0308326
375	2,25	-9,201686	-6,892325	-66,31235	-12,8823604	-22,0697432	-84,2466982	48,3780016	-74,5938674	58,0308326
375	3	-9,201686	-6,892325	-66,31235	-12,8823604	-22,0697432	-84,2466982	48,3780016	-74,5938674	58,0308326
376	0	-10,59515	-7,566557	-51,88546	-14,83321	-24,5206712	-72,166197	31,604723	-61,421095	42,349825
376	0,75	-10,59515	-7,566557	-51,88546	-14,83321	-24,5206712	-72,166197	31,604723	-61,421095	42,349825
376	1,5	-10,59515	-7,566557	-51,88546	-14,83321	-24,5206712	-72,166197	31,604723	-61,421095	42,349825
376	2,25	-10,59515	-7,566557	-51,88546	-14,83321	-24,5206712	-72,166197	31,604723	-61,421095	42,349825
376	3	-10,59515	-7,566557	-51,88546	-14,83321	-24,5206712	-72,166197	31,604723	-61,421095	42,349825
377	0	10,92678	-7,807526	-53,19525	-15,297492	-25,6341776	-74,114912	32,275586	-63,029352	43,361148
377	0,75	10,92678	-7,807526	-53,19525	-15,297492	-25,6341776	-74,114912	32,275586	-63,029352	43,361148
377	1,5	10,92678	-7,807526	-53,19525	-15,297492	-25,6341776	-74,114912	32,275586	-63,029352	43,361148
377	2,25	10,92678	-7,807526	-53,19525	-15,297492	-25,6341776	-74,114912	32,275586	-63,029352	43,361148
377	3	10,92678	-7,807526	-53,19525	-15,297492	-25,6341776	-74,114912	32,275586	-63,029352	43,361148
378	0	-10,93928	-7,827618	-53,44146	-15,314992	-25,5513248	-74,396214	32,486706	-63,286812	43,596108
378	0,75	-10,93928	-7,827618	-53,44146	-15,314992	-25,5513248	-74,396214	32,486706	-63,286812	43,596108

Lampiran A.14

376	1,5	-10,93928	-7,827618	-53,44146	-15,314992	-25,6513248	-74,396214	32,466706	-63,286812	43,596106
378	2,25	-10,93928	-7,827616	-53,44146	-15,314992	-25,6513248	-74,396214	32,466706	-63,286812	43,596106
378	3	-10,93928	-7,827618	-53,44146	-15,314992	-25,6513248	-74,396214	32,466706	-63,286812	43,596106
379	0	-9,734668	-7,147335	-33,97993	-13,6285352	-23,1173376	-52,8088666	15,1509934	-42,7411312	25,2187288
379	0,5	-9,734668	-7,147335	-33,97993	-13,6285352	-23,1173376	-52,8088666	15,1509934	-42,7411312	25,2187288
379	1,8	-9,734668	-7,147335	-33,97993	-13,6285352	-23,1173376	-52,8088666	15,1509934	-42,7411312	25,2187288
379	2,7	-9,734668	-7,147335	-33,97993	-13,6285352	-23,1173376	-52,8088666	15,1509934	-42,7411312	25,2187288
379	3,6	-9,734668	-7,147335	-33,97993	-13,6285352	-23,1173376	-52,8088666	15,1509934	-42,7411312	25,2187288
380	0	-9,706835	-7,136219	-30,12462	-13,589569	-23,0661524	-48,909041	11,340199	-36,5607715	21,3884685
380	0,9	-9,706835	-7,136219	-30,12462	-13,589569	-23,0661524	-48,909041	11,340199	-36,5607715	21,3884685
380	1,8	-9,706835	-7,136219	-30,12462	-13,589569	-23,0661524	-48,909041	11,340199	-36,5607715	21,3884685
380	2,7	-9,706835	-7,136219	-30,12462	-13,589569	-23,0661524	-48,909041	11,340199	-36,5607715	21,3884685
380	3,6	-9,706835	-7,136219	-30,12462	-13,589569	-23,0661524	-48,909041	11,340199	-36,5607715	21,3884685

AKSIAL BALOK PORTAL AS A (ANALISIS 3D)

LABEL	STATION	PD (KN)	PL (KN)	PE (KN)	1,4PD (KN)	1,2PD+1,6PL (KN)	1,2PD+PL+PE (KN)	1,2PD-PL-PE (KN)	0,9PD+PE (KN)	0,9PD-PE (KN)
10	0	5,311427	5,844408	-16,92456	7,4359978	15,7247652	-4,7064396	29,1426804	-12,1442757	21,7048443
10	1	5,311427	5,844408	-16,92456	7,4359978	15,7247652	-4,7064396	29,1426804	-12,1442757	21,7048443
10	2	5,311427	5,844408	-16,92456	7,4359978	15,7247652	-4,7064396	29,1426804	-12,1442757	21,7048443
10	3	5,311427	5,844408	-16,92456	7,4359978	15,7247652	-4,7064396	29,1426804	-12,1442757	21,7048443
10	4	5,311427	5,844408	-16,92456	7,4359978	15,7247652	-4,7064396	29,1426804	-12,1442757	21,7048443
11	0	13,47246	12,93361	47,5112	18,861444	36,860728	76,611762	-18,410638	59,636414	-35,385986
11	1	13,47246	12,93361	47,5112	18,861444	36,860728	76,611762	-18,410638	59,636414	-35,385986
11	2	13,47246	12,93361	47,5112	18,861444	36,860728	76,611762	-18,410638	59,636414	-35,385986
11	3	13,47246	12,93361	47,5112	18,861444	36,860728	76,611762	-18,410638	59,636414	-35,385986
11	4	13,47246	12,93361	47,5112	18,861444	36,860728	76,611762	-18,410638	59,636414	-35,385986
12	0	13,93363	13,3313	46,05603	19,507082	38,050436	76,107686	-16,004374	58,596297	-33,515763
12	1	13,93363	13,3313	46,05603	19,507082	38,050436	76,107686	-16,004374	58,596297	-33,515763
12	2	13,93363	13,3313	46,05603	19,507082	38,050436	76,107686	-16,004374	58,596297	-33,515763
12	3	13,93363	13,3313	46,05603	19,507082	38,050436	76,107686	-16,004374	58,596297	-33,515763
12	4	13,93363	13,3313	46,05603	19,507082	38,050436	76,107686	-16,004374	58,596297	-33,515763
13	0	8,629584	9,784443	102,6383	12,0814176	25,0106096	122,7782438	-82,4983562	110,4049256	-94,8716744
13	2	8,629584	9,784443	102,6383	12,0814176	25,0106096	122,7782438	-82,4983562	110,4049256	-94,8716744
13	4	8,629584	9,784443	102,6383	12,0814176	25,0106096	122,7782438	-82,4983562	110,4049256	-94,8716744
13	6	8,629584	9,784443	102,6383	12,0814176	25,0106096	122,7782438	-82,4983562	110,4049256	-94,8716744
13	8	8,629584	9,784443	102,6383	12,0814176	25,0106096	122,7782438	-82,4983562	110,4049256	-94,8716744
14	0	19,58324	11,85222	-147,938	27,416536	42,46344	-112,585892	183,290108	-130,313084	165,562916
14	2,24	8,573973	3,323006	-147,938	12,0035622	5,8055772	-134,3262264	161,5487730	-140,2214243	155,6545757
14	4,47	-7,700249	-9,876994	-147,938	-10,7803486	-25,0434892	-167,0552928	128,8207072	-154,8682241	141,0077559
14	6,71	-23,97447	-23,07690	-147,938	-33,564258	-65,692348	-190,784354	90,091646	-169,515023	126,360977
14	8,94	-35,43434	-32,00629	-147,938	-49,606076	-93,731272	-222,435498	73,410502	-179,828906	115,047094
15	0	1,605721	1,492038	-89,13519	2,2480094	4,314126	-85,7162868	92,5540932	-87,6900411	90,5803389
15	1	1,605721	1,492038	-89,13519	2,2480094	4,314126	-85,7162868	92,5540932	-87,6900411	90,5803389
15	2	1,605721	1,492038	-89,13519	2,2480094	4,314126	-85,7162868	92,5540932	-87,6900411	90,5803389
15	3	1,605721	1,492038	-89,13519	2,2480094	4,314126	-85,7162868	92,5540932	-87,6900411	90,5803389
15	4	1,605721	1,492038	-89,13519	2,2480094	4,314126	-85,7162868	92,5540932	-87,6900411	90,5803389
16	0	2,509832	2,419905	-71,43047	3,5137648	6,8836464	-65,9987666	76,8621734	-69,1716212	73,6893188
16	1	2,509832	2,419905	-71,43047	3,5137648	6,8836464	-65,9987666	76,8621734	-69,1716212	73,6893188
16	2	2,509832	2,419905	-71,43047	3,5137648	6,8836464	-65,9987666	76,8621734	-69,1716212	73,6893188
16	3	2,509832	2,419905	-71,43047	3,5137648	6,8836464	-65,9987666	76,8621734	-69,1716212	73,6893188
16	4	2,509832	2,419905	-71,43047	3,5137648	6,8836464	-65,9987666	76,8621734	-69,1716212	73,6893188

Lampiran A15

17	0	2,312048	2,262902	-72,09463	3,2366672	6,3951008	-67,0574704	77,1321895	-70,0139868	74,1756732
17	1	2,312048	2,262902	-72,09463	3,2366672	5,3951008	-67,0574704	77,1321895	-70,0139868	74,1756732
17	2	2,312048	2,262902	-72,09463	3,2366672	6,3951008	-67,0574704	77,1321895	-70,0139868	74,1756732
17	3	2,312048	2,262902	-72,09463	3,2366672	6,3951008	-67,0574704	77,1321895	-70,0139868	74,1756732
17	4	2,312048	2,262902	-72,09463	3,2366672	6,3951008	-67,0574704	77,1321895	-70,0139868	74,1756732
18	0	0,7510405	-3,100036	-72,6566	1,0514567	-4,058809	-74,855874	70,4580125	-71,98086355	73,33276645
18	2,24	-10,25823	-11,62925	-72,6566	-14,361522	-30,916676	-96,595926	48,717674	-61,889207	63,424393
18	4,47	-26,53245	-24,82925	-72,6566	-37,14545	-71,56574	-129,32499	15,98861	-96,536005	48,777595
18	6,71	-42,80667	-38,02925	-72,6566	-59,929338	-112,214804	-162,054054	-16,740454	-111,182803	34,130797
18	8,94	-54,26654	-46,95854	-72,6566	-75,973156	-140,253512	-184,735188	-39,421566	-121,496686	23,616914
19	0	-8,391961	-8,854954	-70,60675	-11,7487454	-24,2382796	-89,5320572	51,6814426	-75,1595149	63,0539551
19	1	-8,391961	-8,854954	-70,60675	-11,7487454	-24,2382796	-89,5320572	51,6814426	-75,1595149	63,0539551
19	2	-8,391961	-8,854954	-70,60675	-11,7487454	-24,2382796	-89,5320572	51,6814426	-75,1595149	63,0539551
19	3	-8,391961	-8,854954	-70,60675	-11,7487454	-24,2382796	-89,5320572	51,6814426	-75,1595149	63,0539551
19	4	-8,391961	-8,854954	-70,60675	-11,7487454	-24,2382796	-89,5320572	51,6814426	-75,1595149	63,0539551

AKSIAL BALOK PORTAL AS B (ANALISIS 3D)

LABEL	STATION	PD (KN)	PL (KN)	PE (KN)	1,4PD (KN)	1,2PD+1,6PL (KN)	1,2PD+PL+PE (KN)	1,2PD+PL+PE (KN)	0,9PD-PE (KN)	0,9PD-PE (KN)
37	0	-0,1497492	-8,05E-02	0,9787018	-0,20954868	-3,09E-01	7,18E-01	-1,24E+00	0,84392752	-1,11347608
37	0,63	-0,1407492	-8,05E-02	0,9787018	-0,20954868	-3,09E-01	7,18E-01	-1,24E+00	0,84392752	-1,11347608
37	1,25	-0,1497492	-8,05E-02	0,9787018	-0,20954868	-3,09E-01	7,18E-01	-1,24E+00	0,84392752	-1,11347608
37	1,88	-0,1497492	-8,05E-02	0,9787018	-0,20954868	-3,09E-01	7,18E-01	-1,24E+00	0,84392752	-1,11347608
37	2,50	-0,1497492	-8,05E-02	0,9787018	-0,20954868	-3,09E-01	7,18E-01	-1,24E+00	0,84392752	-1,11347608
38	0	20,85248	15,79088	-275,4425	29,193472	5,03E+01	-2,35E+02	3,16E+02	-256,675268	294,209732
38	1,41	15,64098	11,85012	-275,4425	21,897372	3,77E+01	-2,45E+02	3,06E+02	-261,365618	289,519382
38	2,83	6,09983	3,900414	-275,4425	8,539762	1,36E+01	-2,64E+02	2,87E+02	-269,552653	230,932347
38	4,24	-3,441642	-4,049586	-275,4425	-4,8162968	-1,06E+01	-2,84E+02	2,67E+02	-278,5399776	272,3450222
38	5,66	-8,641038	-7,9797	-275,4425	-12,0982932	-2,31E+01	-2,94E+02	2,57E+02	-253,2199742	267,6650258
39	0	10,38535	9,61854	-93,2756	14,53949	2,79E+01	-7,12E+01	1,15E+02	-83,928785	102,622415
39	1	10,38535	9,61854	-93,2756	14,53949	2,79E+01	-7,12E+01	1,15E+02	-83,928785	102,622415
39	2	10,38535	9,61854	-93,2756	14,53949	2,79E+01	-7,12E+01	1,15E+02	-83,928785	102,622415
39	3	10,38535	9,61854	-93,2756	14,53949	2,79E+01	-7,12E+01	1,15E+02	-83,928785	102,622415
39	4	10,38535	9,61854	-93,2756	14,53949	2,79E+01	-7,12E+01	1,15E+02	-83,928785	102,622415
40	0	22,82913	20,46033	-52,207	31,960782	6,01E+01	-4,35E+00	1,00E+02	-31,660783	72,753217
40	1	22,82913	20,46033	-52,207	31,960782	6,01E+01	-4,35E+00	1,00E+02	-31,660783	72,753217
40	2	22,82913	20,46033	-52,207	31,960782	6,01E+01	-4,35E+00	1,00E+02	-31,660783	72,753217
40	3	22,82913	20,46033	-52,207	31,960782	6,01E+01	-4,35E+00	1,00E+02	-31,660783	72,753217
40	4	22,82913	20,46033	-52,207	31,960782	6,01E+01	-4,35E+00	1,00E+02	-31,660783	72,753217
41	0	23,38421	20,89911	-58,39079	32,737894	6,15E+01	-9,43E+00	1,07E+02	-37,345001	79,436579
41	1	23,38421	20,89911	-58,39079	32,737894	6,15E+01	-9,43E+00	1,07E+02	-37,345001	79,436579
41	2	23,38421	20,89911	-58,39079	32,737894	6,15E+01	-9,43E+00	1,07E+02	-37,345001	79,436579
41	3	23,38421	20,89911	-58,39079	32,737894	6,15E+01	-9,43E+00	1,07E+02	-37,345001	79,436579
41	4	23,38421	20,89911	-58,39079	32,737894	6,15E+01	-9,43E+00	1,07E+02	-37,345001	79,436579
42	0	23,40814	20,989	-19,26363	32,771396	6,17E+01	2,98E+01	6,83E+01	1,603696	40,330956
42	2	23,40814	20,989	-19,26363	32,771396	6,17E+01	2,98E+01	6,83E+01	1,603696	40,330956
42	4	23,40814	20,989	-19,26363	32,771396	6,17E+01	2,98E+01	6,83E+01	1,603696	40,330956
42	6	23,40814	20,989	-19,26363	32,771396	6,17E+01	2,98E+01	6,83E+01	1,603696	40,330956
42	8	23,40814	20,989	-19,26363	32,771396	6,17E+01	2,98E+01	6,83E+01	1,603696	40,330956
43	0	4,073071	7,46E-02	-274,86	5,7022994	5,01E+00	-2,70E+02	2,80E+02	-271,1942361	278,5257639
43	2,24	-6,193783	-8,096327	-274,86	-6,6712962	-2,04E+01	-2,90E+02	2,59E+02	-260,4344047	269,2955953
43	4,47	-20,596	-20,09633	-274,86	-26,8344	-5,69E+01	-3,20E+02	2,30E+02	-293,3984	256,3236
43	6,71	-34,99823	-32,09633	-274,86	-48,997522	-9,34E+01	-3,49E+02	2,01E+02	-306,358407	243,361593
43	8,94	-45,62944	-40,60465	-274,86	-63,681216	-1,20E+02	-3,70E+02	1,80E+02	-315,926466	233,793504

Lampiran A16

43	0	1,313362	1,222109	-145,7623	1,8387068	5,53E+00	-1,43E+02	1,49E+02	-144,5802742	146,9443258
44	1	1,313362	1,222109	-145,7623	1,8387068	5,53E+00	-1,43E+02	1,49E+02	-144,5802742	146,9443258
44	2	1,313362	1,222109	-145,7623	1,8387068	5,53E+00	-1,43E+02	1,49E+02	-144,5802742	146,9443258
44	3	1,313362	1,222109	-145,7623	1,8387068	5,53E+00	-1,43E+02	1,49E+02	-144,5802742	146,9443258
44	4	1,313362	1,222109	-145,7623	1,8387068	5,53E+00	-1,43E+02	1,49E+02	-144,5802742	146,9443258
45	0	0,5678537	0,8083223	-137,9077	0,79499518	1,97E+00	-1,36E+02	1,39E+02	-137,3966317	138,4187683
45	2	0,5678537	0,8083223	-137,9077	0,79499518	1,97E+00	-1,36E+02	1,39E+02	-137,3966317	138,4187683
45	4	0,5678537	0,8083223	-137,9077	0,79499518	1,97E+00	-1,36E+02	1,39E+02	-137,3966317	138,4187683
45	6	0,5678537	0,8083223	-137,9077	0,79499518	1,97E+00	-1,36E+02	1,39E+02	-137,3966317	138,4187683
45	8	0,5678537	0,8083223	-137,9077	0,79499518	1,97E+00	-1,36E+02	1,39E+02	-137,3966317	138,4187683
46	0	-6,468759	-8,972401	-120,7738	-9,0562626	-2,21E+01	-1,38E+02	1,04E+02	-126,5956831	114,9519169
46	2,24	-16,73561	-17,14146	-120,7738	-23,429864	-4,75E+01	-1,56E+02	6,35E+01	-135,635848	105,711751
46	4,47	-31,13783	-27,14146	-120,7738	-43,592962	-8,40E+01	-1,87E+02	5,13E+01	-146,797847	92,749753
46	6,71	-45,54005	-41,14146	-120,7738	-63,75607	-1,20E+02	-2,17E+02	2,50E+01	-161,759845	79,787755
46	8,94	-56,17126	-49,91178	-120,7738	-78,630764	-1,47E+02	-2,65E+02	3,72E+01	-171,327934	70,213666
47	0	-11,52358	-11,29421	-110,9898	-16,133012	-3,19E+01	-1,33E+02	8,59E+01	-121,351022	100,618578
47	1	-11,52358	-11,29421	-110,9898	-16,133012	-3,19E+01	-1,35E+02	8,59E+01	-121,351022	100,618578
47	2	-11,52358	-11,29421	-110,9898	-16,133012	-3,19E+01	-1,36E+02	8,59E+01	-121,351022	100,618578
47	3	-11,52358	-11,29421	-110,9898	-16,133012	-3,19E+01	-1,36E+02	8,59E+01	-121,351022	100,618578
47	4	-11,52358	-11,29421	-110,9898	-16,133012	-3,19E+01	-1,36E+02	8,59E+01	-121,351022	100,618578

GAYA GESER RENCANA BALOK (ANALISIS 2D)

As 1 (Analisis 2D)

Balok	VD (KN)	VL (KN)	VE (KN)	L' (m)	Mpt (KN.m)	VU (KN)		Vu rencana (KN)
						{1}	{2}	
1	86,248	36,467	51,143	8,54	503,900	251,542	326,303	251,542
2	85,081	36,037	26,786	8,54	503,900	249,925	227,261	249,926
3	92,296	39,527	32,891	8,54	503,900	260,329	262,083	260,329
4	87,093	36,254	33,119	8,54	458,840	240,841	255,113	240,841
5	84,967	35,697	20,347	8,54	458,840	238,011	201,195	201,195
6	92,550	39,562	19,018	8,54	458,840	249,043	206,912	206,912
7	37,205	37,951	10,898	8,54	262,190	131,164	107,213	107,213
8	36,112	36,567	7,222	8,54	262,190	129,161	90,507	90,507
9	39,221	39,455	5,907	8,54	262,190	134,336	90,423	90,423

As 2 (Analisis 2D)

Balok	VD (KN)	VL (KN)	VE (KN)	L' (m)	Mpb (KN.m)	VJ (KN)		Vu rencana (KN)
						{1}	{2}	
1	92,732	68,325	45,365	8,54	458,840	263,643	326,901	263,643
2	118,332	96,352	25,037	8,54	667,770	362,199	270,320	290,320
3	145,362	110,369	26,365	8,54	762,000	425,919	335,079	425,919
4	60,362	42,365	50,362	8,54	371,580	189,340	295,065	189,340
5	116,398	88,325	10,652	8,54	458,840	302,047	226,448	226,448
6	105,362	76,352	15,982	8,54	503,900	294,421	228,538	294,421
7	65,632	50,020	35,035	8,54	181,080	150,417	243,908	150,417
8	112,210	86,360	9,936	8,54	221,230	234,823	217,576	234,823
9	105,362	87,874	9,896	8,54	262,190	237,914	209,955	209,955

As A (Analisis 2D)

Balok	VD (KN)	VL (KN)	VE (KN)	L' (m)	Mpb (KN.m)	VU (KN)		Vu rencana (KN)
						{1}	{2}	
1	20,797	18,903	92,855	3,54	298,650	220,010	405,830	220,010
2	38,079	34,283	26,642	7,54	298,650	149,975	169,404	149,975
3	6,401	2,061	31,299	7,54	298,650	95,852	133,906	95,852
4	15,109	10,996	7,250	3,54	181,080	136,165	52,627	52,627
5	29,519	18,512	1,734	7,54	262,190	121,179	51,614	51,614
6	24,016	23,724	2,200	3,54	164,690	143,031	49,482	49,482
7	49,166	52,605	15,131	8,48	376,900	183,082	145,824	145,824
8	60,949	64,895	1,184	8,48	376,900	203,366	110,323	110,323

As B (Analisis 2D)

Balok	VD (KN)	VL (KN)	VE (KN)	L' (m)	Mpb (KN.m)	VU (KN)		Vu rencana (KN)
						{1}	{2}	
1	22,675	22,097	44,430	3,54	181,077	150,792	215,979	150,792
2	53,186	61,277	12,758	7,54	262,193	170,964	145,494	145,494
3	32,937	30,455	8,741	7,54	262,193	131,254	89,716	89,716
4	24,581	23,684	5,507	3,54	181,077	153,992	63,488	63,488
5	29,047	25,996	1,971	7,54	221,225	112,404	55,738	55,738
6	23,496	24,475	0,397	3,54	164,690	142,780	42,023	42,023
7	11,773	18,750	0,325	2,04	164,690	201,109	24,802	23,502
8	35,735	34,751	56,035	5,15	337,164	204,289	284,398	204,289
9	54,071	54,712	0,238	8,48	376,902	190,023	93,194	93,194
10	56,428	58,408	0,093	8,48	376,902	194,699	97,291	97,291

LAMPIRAN B

MOMEN, GAYA AKSIAL DAN GAYA GESER KOLOM

Tabel Momen Rencana Kolom (Analisis 3D)

Kolom K - 3

Join lantai	Lokasi M,k	hn		α		M _{pb}		Mu _{k y} KN.m	Mu _{k x} KN.m
		Arah Y	Arah X	Arah Y	Arah X	B1	B2		
		m	m			KN.m	KN.m		
3	Bawah	3,62	3,57	1,00	1,00	136,013	191,077	229,492	562,044
2	Atas	3,62	3,57	0,50	0,50	181,077	371,577	152,765	576,667
	Bawah	3,60	3,54	0,50	0,50	181,077	371,577	151,921	571,821
1	Atas	3,60	3,54	0,56	0,56	221,225	458,838	208,619	793,665
	Bawah	4,93	4,67	0,44	0,44	221,225	458,838	173,612	636,255
Dasar	Atas	4,93	4,67	1,00	1,00	0,000	0,000	105,365	359,256

Join lantai	Lokasi M,k	Arah Y			Arah X			Mu _k KN.m	Mu _{k x} KN.m
		MD	ML	ME	MD	ML	ME		
		KN.m	KN.m	KN.m	KN.m	KN.m	KN.m		
3	Bawah	20,127	20,336	5,325	11,589	12,362	43,333	55,619	193,419
2	Atas	24,721	24,844	2,122	11,698	12,018	42,926	50,575	191,749
	Bawah	20,509	21,127	14,232	12,196	11,695	91,133	92,103	345,014
1	Atas	18,832	19,019	8,033	12,549	11,827	80,360	64,239	342,414
	Bawah	9,107	7,841	129,245	10,467	10,433	149,525	531,821	615,878
Dasar	Atas	9,581	9,633	110,173	11,132	10,919	143,530	457,006	612,937

Join lantai	Lokasi M,k	Mu _{k y}		Mu _{k x}		Mu _{k pakai}		Mu _{k Desain}	
		{1}	{2}	{1}	{2}	Mu _{k y}	Mu _{k x}	Mu _{k y}	Mu _{k x}
		KN.m	KN.m	KN.m	KN.m	KN.m	KN.m	KN.m	KN.m
3	Bawah	229,49	55,82	562,04	193,42	55,619	193,419	55,619	193,419
2	Atas	152,76	50,57	576,67	191,75	50,575	191,749	92,103	345,014
	Bawah	151,92	92,10	571,82	345,01	92,103	345,014	173,612	615,878
1	Atas	208,62	64,24	793,67	342,41	64,239	342,414	173,612	615,878
	Bawah	173,61	531,82	636,26	615,88	173,612	615,878	101,24	457,01
Dasar	Atas	101,24	457,01	345,36	612,94	101,235	345,356	101,235	345,356

Kolom K - 4

Join lantai	Lokasi M,k	hn		α		M _{pb}		Mu _{k y} KN.m	Mu _{k x} KN.m
		Arah Y	Arah X	Arah Y	Arah X	B1	B2		
		m	m			KN.m	KN.m		
3	Bawah	3,62	3,57	1,00	1,00	136,013	221,225	458,985	686,660
2	Atas	3,62	3,57	0,50	0,50	181,077	458,838	305,529	712,092
	Bawah	3,60	3,54	0,50	0,50	181,077	458,838	303,841	706,108
1	Atas	3,60	3,54	0,56	0,56	221,225	534,031	417,239	1027,513
	Bawah	4,93	4,67	0,44	0,44	221,225	594,031	347,224	823,723
Dasar	Atas	4,93	4,67	1,00	1,00	0,000	0,000	196,356	359,256

Join lantai	Lokasi M,k	Arah Y			Arah X			Mu _{k y} KN.m	Mu _{k x} KN.m
		MD	ML	ME	MD	ML	ME		
		KN.m	KN.m	KN.m	KN.m	KN.m	KN.m		
3	Bawah	36,308	21,551	11,879	13,415	10,999	55,179	107,263	242,312
2	Atas	27,680	23,257	14,448	11,903	10,024	54,798	102,637	238,489
	Bawah	28,796	24,626	19,149	11,117	10,649	100,722	123,463	421,555
1	Atas	32,521	27,440	16,938	11,613	10,655	106,216	120,497	444,126
	Bawah	13,509	10,763	135,396	10,869	10,032	183,044	563,178	750,233
Dasar	Atas	19,496	16,285	124,331	11,521	10,075	182,008	528,860	746,895

Join lantai	Lokasi M,k	Mu _{k y}		Mu _{k x}		Mu _{k pakai}		Mu _{k Desain}	
		{1}	{2}	{1}	{2}	Mu _{k y}	Mu _{k x}	Mu _{k y}	Mu _{k x}
		KN.m	KN.m	KN.m	KN.m	KN.m	KN.m	KN.m	KN.m
3	Bawah	458,93	107,26	686,66	242,31	107,263	242,312	107,263	242,312
2	Atas	305,53	102,64	712,09	238,49	102,637	238,489	123,463	444,126
	Bawah	303,84	123,46	706,11	421,56	123,463	421,555	347,224	750,233
1	Atas	417,24	120,50	1027,51	444,13	120,497	444,126	108,256	528,86
	Bawah	347,22	563,18	823,72	750,23	347,224	750,233	108,256	528,86
Dasar	Atas	108,256	528,86	366,266	746,89	108,256	366,266	108,256	366,266

Kolom K - 5

Join lantai	Lokasi M,k	hn		α		Mpb		Mu,k y	Mu,k x
		Arah Y	Arah X			B1	B2		
		m	m	KN.m	KN.m	KN.m	KN.m		
3	Bawah	3,62	3,57	1,00	1,00	136,013	221,225	229,492	686,660
2	Atas	3,62	3,57	0,50	0,50	181,077	458,838	152,765	712,092
	Bawah	3,60	3,54	0,50	0,50	181,077	458,838	151,921	706,108
1	Atas	3,60	3,54	0,56	0,56	221,225	594,031	208,619	1027,513
	Bawah	4,93	4,67	0,44	0,44	221,225	594,031	173,612	823,723
Dasar	Atas	4,93	4,67	1,00	1,00	0,000	0,000	105,365	359,256

Join lantai	Lokasi M,k	Arah Y			Arah X			Mu,k y	Mu,k x
		MD	ML	ME	MD	ML	ME		
		KN.m	KN.m	KN.m	KN.m	KN.m	KN.m		
3	Bawah	19,976	19,670	14,606	10,457	10,869	10,228	92,232	178,893
2	Atas	25,655	25,064	10,957	10,193	10,801	35,216	87,145	158,496
	Bawah	24,548	23,942	14,646	10,345	10,721	105,982	100,010	441,303
1	Atas	22,253	21,349	17,407	10,006	10,404	103,522	107,008	431,298
	Bawah	5,485	5,444	126,457	10,145	10,083	146,852	515,131	604,624
Dasar	Atas	7,339	8,218	107,936	10,138	10,133	144,618	444,658	595,703

Join lantai	Lokasi M,k	Mu,k y		Mu,k x		Mu,k pakai		Mu,k Desain	
		(1)	(2)	(1)	(2)	Mu,k y	Mu,k x	Mu,k y	Mu,k x
		KN.m	KN.m	KN.m	KN.m	KN.m	KN.m	KN.m	KN.m
3	Bawah	229,49	92,23	686,66	178,89	92,232	178,893	92,232	178,893
2	Atas	152,76	87,14	712,09	158,50	87,145	158,496		
	Bawah	151,92	100,01	706,11	441,30	100,010	441,303	100,010	441,303
1	Atas	208,62	107,01	1027,51	431,30	107,008	431,298	173,612	604,624
	Bawah	173,61	515,13	823,72	604,62	173,612	604,624		
Dasar	Atas	105,69	444,66	359,26	595,70	105,685	359,256		

Kolom K - 6

Join lantai	Lokasi M,k	hn		α		Mpb		Mu,k y	Mu,k x
		Arah Y	Arah X			B1	B2		
		m	m	KN.m	KN.m	KN.m	KN.m		
3	Bawah	3,62	3,57	1,00	1,00	136,013	221,225	458,985	686,660
2	Atas	3,62	3,57	0,50	0,50	181,077	458,838	305,529	712,092
	Bawah	3,60	3,54	0,50	0,50	181,077	458,838	303,841	706,108
1	Atas	3,60	3,54	0,56	0,56	221,225	594,031	417,239	1027,513
	Bawah	4,93	4,67	0,44	0,44	221,225	594,031	347,224	823,723
Dasar	Atas	4,93	4,67	1,00	1,00	0,000	0,000	205,321	359,256

Join lantai	Lokasi M,k	Arah Y			Arah X			Mu,k y	Mu,k x
		MD	ML	ME	MD	ML	ME		
		KN.m	KN.m	KN.m	KN.m	KN.m	KN.m		
3	Bawah	33,582	30,171	10,082	2,478	1,204	35,252	95,713	144,583
2	Atas	23,354	21,068	11,505	3,022	1,648	34,444	34,580	142,225
	Bawah	30,444	27,327	20,503	1,563	0,108	38,100	132,209	354,328
1	Atas	36,353	31,393	18,786	0,310	1,686	86,602	134,466	347,632
	Bawah	10,334	18,971	130,647	0,829	1,062	110,603	544,474	443,938
Dasar	Atas	18,400	16,332	120,317	1,480	2,025	108,453	511,513	436,602

Join lantai	Lokasi M,k	Mu,k y		Mu,k x		Mu,k pakai		Mu,k Desain	
		(1)	(2)	(1)	(2)	Mu,k y	Mu,k x	Mu,k y	Mu,k x
		KN.m	KN.m	KN.m	KN.m	KN.m	KN.m	KN.m	KN.m
3	Bawah	458,98	95,71	686,66	144,58	95,713	144,583	95,713	144,583
2	Atas	305,53	84,58	712,09	142,22	84,580	142,225		
	Bawah	303,84	132,21	706,11	354,33	132,209	354,328	134,466	354,328
1	Atas	417,24	134,47	1027,51	347,63	134,466	347,632	347,224	443,938
	Bawah	347,22	544,47	823,72	443,94	347,224	443,938		
Dasar	Atas	111,16	511,51	368,52	436,60	111,156	368,523		

Kolom K - 1

Join lantai	Lokasi M.k	hn		α		Mph		Mu,k y KN.m	Mu,k x KN.m
		Arah Y	Arah X	Arah Y	Arah X	B1	B2		
		m	m			KN.m	KN.m		
3	Bawah	3,62	3,57	1,00	1,00	164,690	199,185	277,879	309,124
2	Atas	3,62	3,57	0,50	0,50	181,077	408,734	152,765	317,167
	Bawah	3,60	3,54	0,50	0,50	181,077	408,734	151,921	314,502
1	Atas	3,60	3,54	0,56	0,56	181,077	504,722	170,759	436,516
	Bawah	4,93	4,67	0,44	0,44	181,077	504,722	142,104	349,940
Dasar	Atas	4,93	4,67	1,00	1,00	0,000	0,000	105,365	359,256

Join lantai	Lokasi M.k	Arah Y			Arah X			Mu,k y KN.m	Mu,k x KN.m
		MD	ML	ME	MD	ML	ME		
		KN.m	KN.m	KN.m	KN.m	KN.m	KN.m		
3	Bawah	4,727	2,095	11,618	10,374	6,570	17,788	49,192	86,889
2	Atas	9,728	2,181	19,225	12,301	6,104	18,618	53,664	92,285
	Bawah	9,148	1,475	15,638	14,229	5,780	32,928	74,267	151,677
1	Atas	6,046	0,942	20,907	14,350	5,779	36,518	91,326	166,182
	Bawah	0,725	0,750	43,268	4,092	1,587	69,325	174,317	283,004
Dasar	Atas	6,034	0,944	106,722	8,011	3,138	65,623	435,101	273,674

Join lantai	Lokasi M.k	Mu,k y		Mu,k x		Mu,k pakai		Mu,k Desain	
		(1)	(2)	(1)	(2)	Mu,k y KN.m	Mu,k x KN.m	Mu,k y KN.m	Mu,k x KN.m
		KN.m	KN.m	KN.m	KN.m	KN.m	KN.m	KN.m	KN.m
3	Bawah	277,88	49,19	309,12	86,89	49,192	86,889	53,664	92,285
2	Atas	152,76	53,66	317,17	92,29	53,664	92,285	91,326	166,182
	Bawah	151,92	53,66	314,50	151,68	74,267	151,677		
1	Atas	170,76	91,33	436,52	166,18	91,326	166,182	142,104	283,004
	Bawah	142,10	174,32	349,94	283,00	142,104	283,004		
Dasar	Atas	101,24	435,10	156,24	273,67	101,245	156,235		

Kolom K - 2

Join lantai	Lokasi M.k	hn		α		Mph		Mu,k y KN.m	Mu,k x KN.m
		Arah Y	Arah X	Arah Y	Arah X	B1	B2		
		m	m			KN.m	KN.m		
3	Bawah	3,62	3,57	1,00	1,00	164,690	199,185	555,759	309,124
2	Atas	3,62	3,57	0,50	0,50	181,077	408,734	305,529	317,167
	Bawah	3,60	3,54	0,50	0,50	181,077	408,734	303,841	314,502
1	Atas	3,60	3,54	0,56	0,56	181,077	504,722	341,517	436,516
	Bawah	4,93	4,67	0,44	0,44	181,077	504,722	284,209	349,940
Dasar	Atas	4,93	4,67	1,00	1,00	0,000	0,000	168,756	359,256

Join lantai	Lokasi M.k	Arah Y			Arah X			Mu,k y KN.m	Mu,k x KN.m
		MD	ML	ME	MD	ML	ME		
		KN.m	KN.m	KN.m	KN.m	KN.m	KN.m		
3	Bawah	8,654	7,442	22,985	11,171	10,001	29,728	106,046	137,318
2	Atas	6,783	2,679	3,816	11,55	9,755	17,253	24,743	87,750
	Bawah	7,767	2,359	36,51	11,806	9,685	49,549	156,540	217,206
1	Atas	12,265	6,452	41,506	11,454	9,523	46,663	183,968	205,158
	Bawah	3,756	2,091	100,359	3,253	2,665	90,073	406,989	365,528
Dasar	Atas	12,72	7,172	53,712	6,289	5,203	94,794	233,998	389,324

Join lantai	Lokasi M.k	Mu,k y		Mu,k x		Mu,k pakai		Mu,k Desain	
		(1)	(2)	(1)	(2)	Mu,k y KN.m	Mu,k x KN.m	Mu,k y KN.m	Mu,k x KN.m
		KN.m	KN.m	KN.m	KN.m	KN.m	KN.m	KN.m	KN.m
3	Bawah	555,76	106,05	309,12	137,32	106,046	137,318	106,046	137,318
2	Atas	305,53	24,74	317,17	87,75	24,743	87,750	183,968	217,206
	Bawah	303,84	156,54	314,50	217,21	156,540	217,206		
1	Atas	341,52	183,97	436,52	205,16	183,968	205,158	284,209	349,940
	Bawah	284,21	406,99	349,94	365,53	284,209	349,940		
Dasar	Atas	108,256	234,00	120,325	389,32	108,256	120,325		

Tabel Momen Rencana Kolom (Analisis 2D)

Kolom K - 3

Portal Arah X

Join lantai	Lokasi M,k	hn	α	MD	ML	ME	Mpb	Mu, k		Mu, k pakai	Mu, k desain
		m		KN.m	KN.m	KN.m	KN.m	{1}	{2}		
				KN.m	KN.m	KN.m	KN.m	KN.m	KN.m		
3	Bawah	3.57	1.00	2.170	2.622	54.048	262.193	813.819	220.108	220.108	261.718
2	Atas	3.57	0.50	3.077	4.228	63.978	458.838	712.092	261.718	261.718	
	Bawah	3.54	0.50	5.808	0.511	102.681	458.838	706.108	417.950	417.950	440.755
1	Atas	3.54	0.56	6.236	1.695	108.106	503.902	871.614	440.755	440.755	
	Bawah	4.67	0.44	1.052	0.104	188.612	503.902	698.745	755.762	698.745	698.745
Dasar	Atas	4.67	1.00	1.542	0.542	240.183	0.000	359.256	962.853	359.256	

Portal Arah Y

Join lantai	Lokasi M,k	hn	α	MD	ML	ME	Mpb	Mu, k		Mu, k pakai	Mu, k desain
		m		KN.m	KN.m	KN.m	KN.m	{1}	{2}		
				KN.m	KN.m	KN.m	KN.m	KN.m	KN.m		
3	Bawah	3.62	1.00	30.310	31.551	12.979	136.013	428.081	72.320	72.320	76.013
2	Atas	3.62	0.50	37.680	23.257	14.448	181.077	284.958	76.013	76.013	
	Bawah	3.60	0.50	38.796	24.626	19.149	181.077	283.383	115.365	115.365	121.077
1	Atas	3.60	0.56	42.521	27.440	16.938	231.235	406.753	121.077	121.077	
	Bawah	4.93	0.44	53.509	10.763	135.396	231.235	338.498	221.225	231.235	231.235
Dasar	Atas	4.93	1.00	59.496	16.285	124.331	0.000	359.256	576.860	124.331	

Kolom K - 4

Portal Arah X

Join lantai	Lokasi M,k	hn	α	MD	ML	ME	Mpb	Mu, k		Mu, k pakai	Mu, k desain
		m		KN.m	KN.m	KN.m	KN.m	{1}	{2}		
				KN.m	KN.m	KN.m	KN.m	KN.m	KN.m		
3	Bawah	3.57	1.00	5.415	2.952	66.358	262.193	813.819	273.406	273.406	310.207
2	Atas	3.57	0.50	1.903	0.024	76.978	458.838	712.092	310.207	310.207	
	Bawah	3.54	0.50	1.117	0.649	112.681	458.838	706.108	452.391	452.391	514.687
1	Atas	3.54	0.56	1.613	0.655	128.106	667.773	1155.066	514.687	514.687	
	Bawah	4.67	0.44	0.869	0.032	201.612	667.773	925.979	807.506	807.506	807.506
Dasar	Atas	4.67	1.00	1.521	0.075	250.183	0.000	359.256	1002.594	359.256	

Portal Arah Y

Join lantai	Lokasi M,k	hn	α	MD	ML	ME	Mpb	Mu, k		Mu, k pakai	Mu, k desain
		m		KN.m	KN.m	KN.m	KN.m	{1}	{2}		
				KN.m	KN.m	KN.m	KN.m	KN.m	KN.m		
3	Bawah	3.57	1.00	36.308	31.551	13.179	136.013	422.169	112.063	112.063	112.063
2	Atas	3.57	0.50	27.680	23.257	14.562	181.077	281.022	103.094	103.094	
	Bawah	3.54	0.50	28.796	24.626	20.320	181.077	278.660	128.149	128.149	158.221
1	Atas	3.54	0.56	32.521	27.440	26.369	221.225	382.660	158.221	158.221	
	Bawah	4.67	0.44	13.509	10.763	122.365	221.225	306.766	511.053	306.766	359.256
Dasar	Atas	4.67	1.00	19.496	16.285	125.652	0.000	359.256	534.146	359.256	

Kolom K - 5

Portal Arah X

Join lantai	Lokasi M,k	hn m	α	MD KN.m	ML KN.m	ME KN.m	Mpb KN.m	Mu, k		Mu, k pakai KN.m	Mu, k desain KN.m
								{1}	{2}		
3	Bawah	3.57	1.00	0.076	0.645	52.999	262.193	813.819	212.409	212.409	240.569
2	Atas	3.57	0.50	0.052	0.334	60.085	458.838	712.092	240.569	240.569	
	Bawah	3.54	0.50	1.541	0.269	131.939	458.838	706.108	529.739	529.739	535.452
1	Atas	3.54	0.56	2.122	0.468	133.168	503.902	871.614	535.452	535.452	698.745
	Bawah	4.67	0.44	1.797	0.847	179.771	503.902	698.745	721.664	698.745	
Dasar	Atas	4.67	1.00	1.655	0.783	233.144	0.000	359.256	934.953	359.256	

Portal Arah Y

Join lantai	Lokasi M,k	hn m	α	MD KN.m	ML KN.m	ME KN.m	Mpb KN.m	Mu, k		Mu, k pakai KN.m	Mu, k desain KN.m
								{1}	{2}		
3	Bawah	3.57	1.00	19.976	19.670	14.606	136.013	422.169	92.232	92.232	92.232
2	Atas	3.57	0.50	25.655	25.064	10.957	181.077	281.022	87.145	87.145	
	Bawah	3.54	0.50	24.548	23.942	14.646	181.077	278.660	100.010	100.010	107.008
1	Atas	3.54	0.56	22.253	21.349	17.407	221.225	382.660	107.008	107.008	221.225
	Bawah	4.67	0.44	5.485	5.444	126.457	221.225	306.766	515.131	221.225	
Dasar	Atas	4.67	1.00	7.339	8.218	107.936	0.000	359.256	444.658	221.225	

Tabel Gaya Aksial Rencana Kolom (Analisis 3D)

Kolom K3

Kolom Lantai	Ln (m)		Aksial kolom (KN)			MPb (KN m)		P.u.k (KN)		P.u.k rencana (KN)
	B1	B2	PD.k	PL.k	PE.k	B1	B2	{1}	{2}	
3	3.54	8.54	-85,795	-60,434	-5,861	136,013	181,077	234,369	156,615	161,920
	3.54	8.54	-90,216	-60,434	-5,861	181,077	371,577	296,355	161,920	
2	3.54	8.54	-255,22	-137,782	-13,967	181,077	371,577	550,824	431,023	436,327
	3.54	8.54	-259,64	-137,782	-13,967	221,225	458,838	587,242	436,327	
1	3.54	8.54	-488,888	-291,817	9,209	221,225	458,838	989,689	695,738	704,969
	3.54	8.54	-496,58	-291,817	9,209	0,000	0,000	827,817	704,969	

Kolom K4

Kolom Lantai	Ln (m)		Aksial kolom (KN)			MPb (KN m)		P.u.k (KN)		P.u.k rencana (KN)
	B1	B2	PD.k	PL.k	PE.k	B1	B2	{1}	{2}	
3	7.54	8.54	-228,648	-171,207	33,654	136,013	181,077	480,293	245,365	245,270
	7.54	8.54	-246,069	-171,207	33,654	181,077	371,577	549,176	246,270	
2	7.54	8.54	-430,038	-299,284	20,059	181,077	371,577	876,824	585,452	590,757
	7.54	8.54	-434,459	-299,284	20,059	221,225	458,838	907,227	590,757	
1	7.54	8.54	-622,328	-421,138	-24,957	0,000	0,000	1232,436	1057,191	1064,021
	7.54	8.54	-628,02	-421,138	-24,957	0,000	0,000	1161,616	1064,021	

Kolom K5

Kolom Lantai	Ln (m)		Aksial kolom (KN)			MPb (KN m)		P.u.k (KN)		P.u.k rencana (KN)
	B1	B2	PD.k	PL.k	PE.k	B1	B2	{1}	{2}	
3	3.54	8.54	-76,861	-54,56	3,235	135,013	181,077	218,821	105,573	111,878
	3.54	8.54	-81,282	-54,56	3,235	161,077	371,577	280,806	111,878	
2	3.54	8.54	-279,795	-134,913	5,401	181,077	371,577	573,615	381,607	386,941
	3.54	8.54	-284,215	-134,913	5,401	221,225	458,838	610,034	386,941	
1	3.54	8.54	-449,186	-189,646	38,596	221,225	458,838	840,723	479,462	486,293
	3.54	8.54	-454,878	-189,646	38,596	0,000	0,000	676,750	486,293	

Kolom K6

Kolom Lantai	Ln (m)		Aksial kolom (KN)			MPb (KN m)		P.u.k (KN)		P.u.k rencana (KN)
	B1	B2	PD.k	PL.k	PE.k	B1	B2	{1}	{2}	
3	7.54	8.54	-252,511	-196,599	36,66	136,013	181,077	550,050	254,673	259,978
	7.54	8.54	-256,932	-196,599	36,66	181,077	371,577	611,259	259,978	
2	7.54	8.54	-433,65	-319,568	36,325	181,077	371,577	924,880	534,364	539,669
	7.54	8.54	-438,071	-318,568	36,325	221,225	458,838	960,608	539,669	
1	7.54	8.54	-647,917	-411,666	20,537	221,225	458,838	1278,659	901,185	908,017
	7.54	8.54	-653,61	-411,666	20,537	0,000	0,000	1118,540	908,017	

Kolom K1

Kolom Lantai	Ln (m)		Aksial kolom (KN)				MPb (KN m)		Pu,k (KN)		Pu,k rencana (KN)
	B1	B2	PD,k	PL,k	PE,k	B1	B2	{1}	{2}		
3	3.54	8.54	-61.622	-20.367	-4.505	164.690	181.077	153.814	102.150	102.150	108.845
	3.54	8.54	-67.201	-20.367	-4.505	181.077	371.577	186.608	108.845	108.845	
2	3.54	8.54	-82.253	-37.452	-21.692	181.077	371.577	220.352	204.198	204.198	210.892
	3.54	8.54	-87.832	-37.452	-21.692	181.077	458.838	236.428	210.892	210.892	
1	3.54	8.54	-157.712	-56.887	-28.603	181.077	458.838	330.209	332.110	332.110	332.110
	3.54	8.54	-152.02	-56.887	-28.603	0.000	0.000	219.352	325.280	219.352	

Kolom K2

Kolom Lantai	Ln (m)		Aksial kolom (KN)				MPb (KN m)		Pu,k (KN)		Pu,k rencana (KN)
	B1	B2	PD,k	PL,k	PE,k	B1	B2	{1}	{2}		
3	7.54	8.54	-72.727	-54.665	50.95	164.690	181.077	198.011	89.195	89.195	94.500
	7.54	8.54	-68.306	-54.665	50.95	181.077	371.577	240.155	94.500	94.500	
2	7.54	8.54	-178.903	-126.407	107.944	181.077	371.577	431.611	153.669	153.669	159.194
	7.54	8.54	-174.482	-126.407	107.944	181.077	458.638	447.405	159.194	159.194	
1	7.54	8.54	-262.992	-182.094	187.509	181.077	458.638	988.717	343.507	343.507	350.337
	7.54	8.54	-257.21	-182.094	187.509	0.000	0.000	451.269	350.337	350.337	

Tabel Gaya Aksial Rencana Kolom (Analisis 2D)

Kolom K3

Kolom Lantai	Ln (m)	Aksial kolom (KN)			MPb (KN.m)	Pu,k (KN)		Pu,k (KN)	Pu,k rencana (KN)
		PD,k	PL,k	PE,k		(1)	(2)		
3	8,54	-92,167	-93,119	-3,917	262,193	255,955	172,830	172,830	174,640
	8,54	-93,676	-93,119	-3,917	458,838	303,591	174,640	174,640	
2	8,54	-285,791	-184,125	-16,095	458,838	600,867	499,392	499,392	501,914
	8,54	-287,892	-184,125	-16,095	503,902	613,627	501,914	501,914	
1	8,54	-479,191	-275,605	-30,800	503,902	910,345	836,033	836,033	841,239
	8,54	-483,530	-275,605	-30,800	0,000	797,092	841,239	841,239	

Kolom K4

Kolom Lantai	Ln (m)	Aksial kolom (KN)			MPb (KN.m)	Fu,k (KN)		Pu,k (KN)	Pu,k rencana (KN)
		PD,k	PL,k	PE,k		(1)	(2)		
3	8,54	-238,521	-175,203	35,555	262,193	495,814	231,607	231,607	255,709
	8,54	-258,648	-175,103	35,555	458,838	562,895	255,709	255,709	
2	8,54	-440,038	-299,265	20,059	458,838	883,724	597,442	597,442	614,757
	8,54	-454,459	-299,284	20,059	667,773	947,817	614,757	614,757	
1	8,54	-705,465	-368,265	-34,957	667,773	1283,804	1170,519	1170,519	1170,336
	8,54	-705,325	-368,236	-34,957	0,000	1127,239	1170,336	1170,336	

Kolom K5

Kolom Lantai	Ln (m)	Aksial kolom (KN)			MPb (KN.m)	Pu,k (KN)		Pu,k (KN)	Pu,k rencana (KN)
		PD,k	PL,k	PE,k		(1)	(2)		
3	8,54	-85,706	-89,606	-0,944	262,193	245,481	151,426	151,428	154,172
	8,54	-87,993	-89,606	-0,944	458,838	293,935	154,172	154,172	
2	8,54	-280,361	-179,683	-1,539	458,838	590,503	432,430	432,430	434,809
	8,54	-282,344	-179,683	-1,539	503,902	603,138	434,809	434,809	
1	8,54	-431,007	-269,607	-5,290	503,902	853,654	673,173	673,173	678,380
	8,54	-435,346	-269,607	-5,290	0,000	740,200	678,380	678,380	

Kolom K6

Kolom Lantai	Ln (m)	Aksial kolom (KN)			MPb (KN.m)	Pu,k (KN)		Pu,k (KN)	Pu,k rencana (KN)
		PD,k	PL,k	PE,k		(1)	(2)		
3	8,54	-262,511	-236,595	36,66	262,193	585,469	286,673	286,673	294,378
	8,54	-208,932	-236,599	36,66	458,838	638,264	294,378	294,378	
2	8,54	-433,65	-318,568	40,325	458,838	897,285	518,364	518,364	595,669
	8,54	-498,071	-318,569	40,325	667,773	1013,358	595,669	595,669	
1	8,54	-727,917	-441,666	30,537	667,773	1384,449	972,185	972,185	979,017
	8,54	-733,61	-441,666	30,537	0,000	1234,040	979,017	979,017	

Tabel Gaya Geser Rencana Kolom (Analisis 3D)

Kolom K3

Kolom Lantai	h _n (m)		Mu.k Desain (KN.m)		Gaya Geser Portal Ararah Y (KN)			Gaya Geser Portal Ararah X (KN)			Vu.k y (KN)		Vu.k x (KN)		Vu.k (KN)		Vu.k pakai (KN)	
	Aarah Y	Aarah X	Mu.k y	Mu.k x	VD.k	VL.k	VE.k	VD.k	VL.k	VE.k	{1}	{2}	{1}	{2}	Vu.k y	Vu.k x	Vu.k y	Vu.k x
3	3,62	3,57	55,619	136,419	11,212	11,295	1,862	-0,822	-1,095	16,565	30,729	26,550	76,425	64,726	26,550	64,726	26,550	64,726
2	3,6	3,54	92,103	248,014	9,835	10,036	1,550	-1,166	-0,881	30,373	51,168	23,020	140,121	119,628	23,020	119,628	23,020	119,628
1	4,73	4,67	156,315	478,878	3,613	3,393	46,489	-0,331	-0,263	46,224	66,095	191,988	205,087	184,367	66,095	184,367	66,095	184,367

Kolom K4

Kolom Lantai	h _n (m)		Mu.k Desain (KN.m)		Gaya Geser Portal Ararah Y (KN)			Gaya Geser Portal Ararah X (KN)			Vu.k y (KN)		Vu.k x (KN)		Vu.k (KN)		Vu.k pakai (KN)	
	Aarah Y	Aarah X	Mu.k y	Mu.k x	VD.k	VL.k	VE.k	VD.k	VL.k	VE.k	{1}	{2}	{1}	{2}	Vu.k y	Vu.k x	Vu.k y	Vu.k x
3	3,62	3,57	67,263	105,312	15,997	13,702	1,607	-0,329	-0,256	12,494	37,162	32,475	58,995	49,453	32,475	49,453	32,475	49,453
2	3,6	3,54	123,436	244,555	15,329	13,011	6,522	-0,583	-0,326	30,235	69,576	50,991	138,167	119,957	50,991	119,957	50,991	119,957
1	4,73	4,67	156,315	453,233	6,408	5,252	50,432	-0,464	-0,125	43,599	66,095	212,044	194,104	174,177	66,095	174,177	66,095	174,177

Kolom K5

Kolom Lantai	h _n (m)		Mu.k Desain (KN.m)		Gaya Geser Portal Ararah Y (KN)			Gaya Geser Portal Ararah X (KN)			Vu.k y (KN)		Vu.k x (KN)		Vu.k (KN)		Vu.k pakai (KN)	
	Aarah Y	Aarah X	Mu.k y	Mu.k x	VD.k	VL.k	VE.k	VD.k	VL.k	VE.k	{1}	{2}	{1}	{2}	Vu.k y	Vu.k x	Vu.k y	Vu.k x
3	3,62	3,57	52,232	125,496	11,408	11,184	1,391	-0,163	-0,417	15,361	28,857	24,846	70,306	61,040	24,414	61,040	24,414	61,040
2	3,6	3,54	100,110	232,303	3,269	3,799	29,536	-0,234	-0,501	42,375	55,561	123,966	131,245	168,969	55,561	131,245	55,561	131,245
1	4,73	4,67	156,315	467,624	2,490	2,653	45,513	-0,551	-0,419	44,946	66,095	186,367	200,267	178,913	66,095	178,913	66,095	178,913

Kolom K6

Kolom Lantai	h _n (m)		Mu.k Desain (KN.m)		Gaya Geser Portal Ararah Y (KN)			Gaya Geser Portal Ararah X (KN)			Vu.k y (KN)		Vu.k x (KN)		Vu.k (KN)		Vu.k pakai (KN)	
	Aarah Y	Aarah X	Mu.k y	Mu.k x	VD.k	VL.k	VE.k	VD.k	VL.k	VE.k	{1}	{2}	{1}	{2}	Vu.k y	Vu.k x	Vu.k y	Vu.k x
3	3,62	3,57	59,713	104,583	14,234	12,810	1,147	-0,375	-0,713	12,424	32,991	28,074	58,590	48,890	28,074	48,890	28,074	48,890
2	3,6	3,54	132,209	234,328	16,699	14,680	7,322	-0,311	-0,394	28,675	73,449	56,667	132,389	114,130	56,667	114,130	56,667	114,130
1	4,73	4,57	156,315	443,938	5,579	4,913	48,371	-0,445	-0,599	42,535	66,095	202,635	190,123	169,303	66,095	169,303	66,095	169,303

Kolom K1

Kolom Lantai	hn (m)		Mu.k Desain (KN m)		Gaya Geser Portal Arah Y (KN)				Gaya Geser Portal Arah X (KN)				Vu.k y (KN)		Vu.k x (KN)		Vu.k pakat (KN)				
	Arah Y	Arah X	Mu.k y	Mu.k x	VD.k	VL.k	VE.k	VE*	VL.k	VL.k	VE*	VE*	VL.k	VL.k	(1)	(2)	Vu.k y	Vu.k x	Vu.k y	Vu.k x	
3	3.62	3.57	55.619	136.419	3.614	1.069	8.461	-5.669	-3.17	12.651	12.651	30.729	38.715	30.729	38.715	75.425	42.016	30.729	42.016	30.729	42.016
2	3.6	3.54	92.103	248.014	3.798	0.604	21.884	-7.145	-2.89	22.362	22.362	51.168	92.396	51.168	92.396	140.121	79.429	51.168	79.429	51.168	79.429
1	4.73	4.67	156.315	478.878	1.312	0.232	29.124	-2.35	-0.918	43.579	43.579	66.095	116.186	66.095	116.186	205.087	171.437	66.095	171.437	66.095	171.437

Kolom K2

Kolom Lantai	hn (m)		Mu.k Desain (KN m)		Gaya Geser Portal Arah Y (KN)				Gaya Geser Portal Arah X (KN)				Vu.k y (KN)		Vu.k x (KN)		Vu.k pakat (KN)				
	Arah Y	Arah X	Mu.k y	Mu.k x	VD.k	VL.k	VE.k	VE*	VL.k	VL.k	VE*	VE*	VL.k	VL.k	(1)	(2)	Vu.k y	Vu.k x	Vu.k y	Vu.k x	
3	3.62	3.57	67.263	105.312	3.859	2.53	6.7	-5.65	-4.939	9.24	9.24	37.162	32.696	37.162	32.696	55.998	27.655	32.696	27.655	32.696	27.695
2	3.6	3.54	123.436	244.555	5.008	2.203	42.004	-5.875	-4.802	24.533	24.533	68.576	175.127	68.576	175.127	153.167	65.533	68.576	65.533	68.576	65.533
1	4.73	4.67	155.376	453.233	3.199	1.915	29.917	-1.613	-1.408	47.722	47.722	65.595	124.454	65.595	124.454	153.104	153.104	65.595	153.104	65.595	153.104

Tabel Gaya Geser Rencana Kolom (2D)

Kolom K1

Kolom Lantai	Arah Y	Mu,k,y	Gaya Geser Portal Arah X (KN)			Gaya Geser Portal Arah Y (KN)			Vu,k x (KN)		Vu,k y (KN)		Vu,k (KN)		Vu,k pakai (KN)	
			VD,k	VL,k	VE,k	VD,k	VL,k	VE,k	{1}	{2}	{1}	{2}	Vu,k x	Vu,k y	Vu,k x	Vu,k y
3	3.57	136.419	3.614	1.069	8.461	-14.834	-7.066	26.988	76.425	38.715	76.425	86.618	76.425	86.618	76.425	86.618
2	3.54	248.014	3.614	1.069	8.461	-14.834	-7.066	26.988	76.425	38.715	76.425	86.618	76.425	86.618	76.425	86.618
1	4.67	478.878	3.798	0.604	21.884	-30.888	-13.463	44.961	140.121	92.396	140.121	136.047	140.121	136.047	140.121	136.047
			3.798	0.604	21.884	-30.888	-13.463	44.961	140.121	92.396	140.121	136.047	140.121	136.047	140.121	136.047
			1.312	0.232	29.124	-20.27118	-16.206	101.153	205.087	118.186	205.087	372.184	205.087	372.184	205.087	372.184
			1.312	0.232	29.124	-20.27118	-16.206	101.153	205.087	118.186	205.087	372.184	205.087	372.184	205.087	372.184

Kolom K2

Kolom Lantai	Arah Y	Mu,k,y	Gaya Geser Portal Arah X (KN)			Gaya Geser Portal Arah Y (KN)			Vu,k x (KN)		Vu,k y (KN)		Vu,k (KN)		Vu,k pakai (KN)	
			VD,k	VL,k	VE,k	VD,k	VL,k	VE,k	{1}	{2}	{1}	{2}	Vu,k x	Vu,k y	Vu,k x	Vu,k y
3	3.57	105.312	3.859	2.53	6.7	-11.365	-5.066	27.688	58.998	32.696	58.998	94.581	32.696	94.581	32.696	94.581
2	3.54	244.555	3.859	2.53	6.7	-11.365	-5.066	27.688	58.998	32.696	58.998	94.581	32.696	94.581	32.696	94.581
1	4.67	453.233	5.008	2.203	42.004	-20.888	-11.463	44.961	138.167	175.127	138.167	149.047	138.167	149.047	138.167	149.047
			5.008	2.203	42.004	-20.888	-11.463	44.961	138.167	175.127	138.167	149.047	138.167	149.047	138.167	149.047
			3.199	1.915	29.917	-22.352	-15.213	111.235	194.104	124.464	194.104	410.511	194.104	410.511	194.104	410.511
			3.199	1.915	29.917	-22.352	-15.213	111.235	194.104	124.464	194.104	410.511	194.104	410.511	194.104	410.511

Kolom K3

Kolom Lantai	hn (m)	Mu,k desain (KN.m)	Gaya Geser Portal Arah X (KN)			Gaya Geser Portal Arah Y (KN)			Vu,k x (KN)		Vu,k y (KN)		Vu,k (KN)		Vu,k pakai (KN)	
			VD,k	VL,k	VE,k	VD,k	VL,k	VE,k	{1}	{2}	{1}	{2}	Vu,k x	Vu,k y	Vu,k x	Vu,k y
3	3.57	136.419	11.212	11.295	1.862	5.032	3.245	28.271	76.425	26.550	76.425	120.745	26.550	120.745	26.550	120.745
2	3.54	248.014	11.212	11.295	1.862	5.032	3.245	28.271	76.425	26.550	76.425	120.745	26.550	120.745	26.550	120.745
1	4.67	478.878	9.835	10.036	1.550	7.916	5.184	66.277	140.121	23.020	140.121	277.197	23.020	277.197	23.020	277.197
			9.835	10.036	1.550	7.916	5.184	66.277	140.121	23.020	140.121	277.197	23.020	277.197	23.020	277.197
			3.613	3.393	46.489	-10.670	-8.317	80.178	205.087	191.988	205.087	303.747	205.087	303.747	205.087	303.747
			3.613	3.393	46.489	-10.670	-8.317	80.178	205.087	191.988	205.087	303.747	205.087	303.747	205.087	303.747

Kolom K4

Kolom Lantai	Arah Y	Gaya Geser Portal Arah X (KN)			Gaya Geser Portal Arah Y (KN)			Vu,k x (KN)		Vu,k y (KN)		Vu,k (KN)		Vu,k pakai (KN)	
		VD,k	VL,k	VE,k	VD,k	VL,k	VE,k	{1}	{2}	{1}	{2}	Vu,k x	Vu,k y	Vu,k x	Vu,k y
3	3.57	15.997	13.702	1.607	-0.329	-0.256	12.494	58.998	32.475	58.998	49.453	32.475	49.453	32.475	49.453
		15.997	13.702	1.607	-0.329	-0.256	12.494	58.998	32.475	58.998	49.453	32.475	49.453	32.475	49.453
2	3.54	15.329	13.017	6.522	-0.683	-0.326	30.235	138.167	50.991	138.167	119.957	50.991	119.957	50.991	119.957
		15.329	13.017	6.522	-0.683	-0.326	30.235	138.167	50.991	138.167	119.957	50.991	119.957	50.991	119.957
1	4.67	6.408	5.252	50.432	-0.464	-0.125	43.699	194.104	212.044	194.104	174.177	194.104	174.177	194.104	174.177
		6.408	5.252	50.432	-0.464	-0.125	43.699	194.104	212.044	194.104	174.177	194.104	174.177	194.104	174.177

Kolom K5

Kolom Lantai	Arah Y	Gaya Geser Portal Arah X (KN)			Gaya Geser Portal Arah Y (KN)			Vu,k x (KN)		Vu,k y (KN)		Vu,k (KN)		Vu,k pakai (KN)	
		VD,k	VL,k	VE,k	VD,k	VL,k	VE,k	{1}	{2}	{1}	{2}	Vu,k x	Vu,k y	Vu,k x	Vu,k y
3	3.57	11.408	11.184	1.391	-0.163	-0.417	15.361	70.306	24.846	70.306	61.040	24.414	61.040	24.414	61.040
		11.408	11.184	1.391	-0.163	-0.417	15.361	70.306	24.846	70.306	61.040	24.414	61.040	24.414	61.040
2	3.54	3.269	3.799	29.536	-0.234	-0.501	42.375	131.245	123.966	131.245	168.969	131.245	131.245	131.245	131.245
		3.269	3.799	29.536	-0.234	-0.501	42.375	131.245	123.966	131.245	168.969	131.245	131.245	131.245	131.245
1	4.67	2.490	2.653	45.513	-0.551	-0.419	44.946	200.267	186.367	200.267	178.913	200.267	178.913	200.267	178.913
		2.490	2.653	45.513	-0.551	-0.419	44.946	200.267	186.367	200.267	178.913	200.267	178.913	200.267	178.913

Kolom K6

Kolom Lantai	Arah Y	Gaya Geser Portal Arah X (KN)			Gaya Geser Portal Arah Y (KN)			Vu,k x (KN)		Vu,k y (KN)		Vu,k (KN)		Vu,k pakai (KN)	
		VD,k	VL,k	VE,k	VD,k	VL,k	VE,k	{1}	{2}	{1}	{2}	Vu,k x	Vu,k y	Vu,k x	Vu,k y
3	3.57	14.234	12.810	1.147	-0.375	-0.713	12.424	58.590	28.074	58.590	48.890	28.074	48.890	28.074	48.890
		14.234	12.810	1.147	-0.375	-0.713	12.424	58.590	28.074	58.590	48.890	28.074	48.890	28.074	48.890
2	3.54	16.699	14.680	7.322	-0.311	-0.394	28.675	132.389	56.667	132.389	114.130	56.667	114.130	56.667	114.130
		16.699	14.680	7.322	-0.311	-0.394	28.675	132.389	56.667	132.389	114.130	56.667	114.130	56.667	114.130
1	4.67	5.579	4.913	48.371	-0.448	-0.599	42.535	190.123	202.635	190.123	169.303	190.123	169.303	190.123	169.303
		5.579	4.913	48.371	-0.448	-0.599	42.535	190.123	202.635	190.123	169.303	190.123	169.303	190.123	169.303

LAMPIRAN C
PEMBEBANAN GEMPA

Pembebanan Gempa Portal 1

No	Bagian	Berat	Satuan	P (m)	l (m)	t (m)	Total (KN)	Ket
				panjang x	lebar y	tinggi z		
lantai 3								
Beban Mati								
1	Pelat lantai	4.32	KN/m ²	118	2	1	1003.968	1 = 1 satuan
2	blk induk	1.444	KN/m	146	1	1	210.824	
3	blk anak	0.832	KN/m	52	1	1	43.264	
4	kolom	1.131	KN/m	28	1	1	31.668	
5	dinding	2.5	KN/m ²	116.2	1	2	581	
WD							1870.724	
Beban Hidup								
1	Pelat lantai	5	KN/m ²	116.2	2	0.5	581	Reduksi = 0.5
WL							581	
W3							2451.724	
lantai 2								
Beban Mati								
1	Pelat lantai	4.64	KN/m ²	118	2	1	1078.336	1 = 1 satuan
2	blk induk	1.444	KN/m	146	1	1	210.824	
3	blk anak	0.832	KN/m	52	1	1	43.264	
4	kolom	1.131	KN/m	56	1	1	63.336	
5	dinding	2.5	KN/m ²	116.2	1	4	1162	
WD							2557.76	
Beban Hidup								
1	Pelat lantai	5	KN/m ²	116.2	2	0.5	581	Reduksi = 0.5
WL							581	
W2							3138.76	
lantai 1								
Beban Mati								
1	Pelat lantai	4.64	KN/m ²	118	2	1	1078.336	1 = 1 satuan
2	blk induk	1.444	KN/m	146	1	1	210.824	
3	blk anak	0.832	KN/m	52	1	1	43.264	
4	kolom	1.131	KN/m	64.05	1	1	72.44055	
5	dinding	2.5	KN/m ²	116.2	1	4.58	1330.49	
WD							2735.355	
Beban Hidup								
1	Pelat lantai	5	KN/m ²	116.2	2	0.5	581	Reduksi = 0.5
WL							581	
W1							3316.355	
W total							8906.839	

$V = C I K W_t$ Dimana:

C = Koefisien gempa dasar
T = Waktu getar bangunan ($0.06H^{3/4}$)
H = Tinggi Bangunan = 13.15
I = Faktor keutamaan Bangunan
K = Faktor jenis struktur
W_t = Berat total bangunan
V_{x,y} = Gaya gempa horizontal

T = 0.587
C = 0.07
I = 1.5
K = 1

$$V_{x,y} = C \cdot I \cdot K \cdot W_t = 935.21805$$

Distribusi Beban Gempa

No	Bagian	Wi (KN)	Hi (M)	Wi Hi (KN.m)	Fx,y
					(KN)
1	tingkat 3	2451.724	13.15	32240.1706	306.3654
2	tingkat 2	3138.76	9.15	28719.654	344.1756
3	tingkat 1	3316.35455	5.15	17079.22593	204.677
			Wi Hi	78039.05353	

Pembebanan Gempa Portal 2

No	Bagian	Berat	Satuan	P (m)	l (m)	t (m)	Total (KN)	Ket
				panjang x	lebar y	tinggi z		
lantai 3								
Beban Mati								
1	Pelat lantai	4.32	KN/m ²	114.4	2	1	988.416	1 = 1 satuan
2	Pelat Tribun	4.8	KN/m ²	114.4	2	1	1098.24	
2	blk induk	1.444	KN/m	140.2	1	1	202.4488	
3	blk anak	0.832	KN/m	52	1	1	43.264	
4	kolom	1.131	KN/m	28	1	1	31.668	
5	dinding	2.5	KN/m ²	116.2	1	2	581	
WD							2945.037	
Beban Hidup								
1	Pelat lantai	5	KN/m ²	114.4	2	0.5	572	Reduksi = 0.5
WL							572	
W3							3517.037	
lantai 2								
Beban Mati								
1	Pelat lantai	4.64	KN/m ²	116.2	2	1	1078.336	1 = 1 satuan
2	blk induk	1.444	KN/m	140.2	1	1	202.4488	
3	blk anak	0.832	KN/m	52	1	1	43.264	
4	kolom	1.131	KN/m	56	1	1	63.336	
5	dinding	2.5	KN/m ²	116.2	1	4	1162	
WD							2549.385	
Beban Hidup								
1	Pelat lantai	5	KN/m ²	116.2	2	0.5	581	Reduksi = 0.5
WL							581	
W2							3130.385	
lantai 1								
Beban Mati								
1	Pelat lantai	4.64	KN/m ²	116.2	2	1	1078.336	1 = 1 satuan
2	blk induk	1.444	KN/m	140.2	1	1	202.4488	
3	blk anak	0.832	KN/m	52	1	1	43.264	
4	kolom	1.131	KN/m	64.05	1	1	72.44055	
5	dinding	2.5	KN/m ²	116.2	1	4.58	1330.49	
WD							2726.979	
Beban Hidup								
1	Pelat lantai	5	KN/m ²	116.2	2	0.5	581	Reduksi = 0.5
WL							581	
W1							3907.979	
W total							9955.401	

$$V = C I K W_t$$

Dimana:

C = Koefisien gempa dasar

T = Waktu getar bangunan ($0.06H^{3/4}$) H_i = Tinggi Bangunan = 13.15

I = Faktor keutamaan Bangun

K = Faktor jenis struktur

 W_t = Berat total bangunan $V_{x,y}$ = Gaya gempa horizontal

$$T = 0.587$$

$$C = 0.07$$

$$I = 1.5$$

$$K = 1$$

$$V_{x,y} = C \cdot I \cdot K \cdot W_t = 1045.317$$

Distribusi Beban Gempa

No	Bagian	W_i (KN)	H_i (M)	$W_i H_i$ (KN.m)	$F_{x,y}$
					(KN)
1	tingkat 3	3517.0368	13.15	46249.03392	525.8988
2	tingkat 2	3130.3848	9.15	28643.02092	325.7005
3	tingkat 1	3307.97935	5.15	17036.09365	193.7178
			$W_i H_i$	91928.14849	

Pembebanan Gempa Portal B

No	Bagian	Berat	Satuan	P (m)	l (m)	t (m)	Total (KN)	Ket
				panjang x	lebar y	tinggi z		
lantai 3								
Beban Mati								
1	Pelat lantai	4.32	KN/m ²	9	4	1	155.52	1 = 1 satuan
2	Pelat tribun	4.8	KN/m ²	9	4.49	1	193.968	
3	blk induk	1.444	KN/m	22	1	1	31.768	
4	blk anak	0.832	KN/m	8	1	1	6.656	
5	blk miring induk	1.444	KN/m	4.49	1	1	6.43356	
6	blk miring anak	0.803	KN/m	3.98	1	1	7.21094	
7	kolom	1.131	KN/m	4	1	1	4.524	
8	dinding	2.5	KN/m ²	4.5	1	2	22.5	
WD							428.6305	
Beban Hidup								
1	Pelat lantai	5	KN/m ²	9	4	0.5	90	Reduksi = 0.5
2	Pelat tribun	5	KN/m ²	9	4.49	0.5	101.025	
WL							191.025	
W3							619.6555	
lantai 2								
Beban Mati								
1	Pelat lantai	4.64	KN/m ²	9	8	1	334.08	1 = 1 satuan
2	Pelat tribun	4.8	KN/m ²	9	8.98	1	387.936	
3	blk induk	1.444	KN/m	30	1	1	43.32	
4	blk anak	0.832	KN/m	20	1	1	16.64	
5	blk miring induk	1.444	KN/m	8.98	1	1	12.96712	
6	blk miring anak	0.803	KN/m	17.96	1	1	14.42188	
7	kolom	1.131	KN/m	12	1	1	13.572	
8	dinding	2.5	KN/m ²	9	1	4	90	
WD							912.937	
Beban Hidup								
1	Pelat lantai	5	KN/m ²	9	8	0.5	180	Reduksi = 0.5
2	Pelat tribun	5	KN/m ²	9	8.98	0.5	202.05	
WL							382.05	
W2							1294.987	
lantai 1								
Beban Mati								
1	Pelat lantai	4.64	KN/m ²	9	14	1	584.64	1 = 1 satuan
2	Pelat tribun	4.8	KN/m ²	9	10.1	1	436.32	
3	Pelat kantilever	4.32	KN/m ²	9	2.5	1	97.2	
3	blk induk	1.444	KN/m	42.5	1	1	61.37	
4	blk anak	0.832	KN/m	20	1	1	16.64	
5	blk miring induk	1.444	KN/m	10.1	1	1	14.5844	
6	blk miring anak	0.803	KN/m	20.2	1	1	16.2206	
7	kolom	1.131	KN/m	18.3	1	1	20.6973	
8	dinding	2.5	KN/m ²	9	1	4.58	103.05	
WD							1350.722	
Beban Hidup								
1	Pelat lantai	5	KN/m ²	9	14	0.5	315	Reduksi = 0.5
2	Pelat tribun	5	KN/m ²	9	10.1	0.5	227.25	
WL							542.25	
W1							1892.972	
W total							3807.615	

$V = C I K Wt$ Dimana:

C = Koefisien gempa dasar
 T = Waktu getar bangunan ($0.06H^{3/4}$)
 H = Tinggi Bangunan = 13.15
 I = Faktor ketamaan Bangunan
 K = Faktor jenis struktur
 Wt = Berat total bangunan
 $V_{x,y}$ = Gaya gempa horizontal

$T = 0.586966$
 $C = 0.07$
 $I = 1.5$
 $K = 1$

$V_{x,y} = C * I * K * Wt = 399.7996$

Distribusi Beban Gempa

No	Bagian	W_i (KN)	H_i (M)	$W_i H_i$ (KN.m)	$F_{x,y}$
					(KN)
1	tingkat 3	619.6555	13.15	8148.469825	109.5176
2	tingkat 2	1294.987	9.15	11849.13105	159.2554
3	tingkat 1	1892.9723	5.15	9748.807345	131.0265
			$W_i H_i$	29746.40822	

LAMPIRAN D
DESAIN BALOK

Batuk	B9		
Batang	33		
Kombinas: Beban	Gravitasi&Gempa	Gravitasi	
Mu (KN m)	193,393	191,407	
MA (KN m)	76,833	18,243	
MB (KN m)	90,242	107,877	
MC(KN.m)	4,222	60,714	
Cb	2,22	2,09	
Profil	W16x36	W16x36	
fy (Mpa)	250	250	
fc (Mpa)	70	70	
E (Mpa)	200000	200000	
ry (mm)	38,61	38,61	
X1 (Mpa)	11721,50	11721,50	
X2 (1/Mpa)²	0,000438	0,000438	
Zx (mm³)	1045772,10	1046772,10	
Sx (mm²)	925869,12	925869,12	
Lp (mm)	1921,92	1921,92	
Lr (mm)	5562,76	5562,76	
L (mm)	3600	3600	
Penampang	Lp<L<Li	Lp<L<Li	
Mp (KN m)	Kompak	Kompak	
Mf (KN.m)	262,19	262,19	
Mn (KN.m)	166,66	166,66	
Mn pakai (KN.m)	484,90	455,11	
0.9 Mn (KN m)	262,19	262,19	
0.9Mn > Mu	235,971	235,971	
	AMAN	AMAN	
Kuat Tarik Tersedia			
P (KN)	396,637		
Ag (mm²)	6838,696		
T (KN)	1538,707		
T > P (KN)	AMAN		
Kontrol Defleksi			
L (mm)	9000		
Defleksi diizinkan (mm)	25,00		
Defleksi dari SAP	16,00		
	AMAN		

Batok Batang Kombinasi Beban	B9 33	
	Gravitasi&Gempa	Gravitasi
Mu (KN.m)	188,818	212,245
MA (KN.m)	36,576	33,391
MB (KN.m)	92,865	116,46
MC (KN.m)	16,576	33,057
Cb	2,30	2,22
Profil	W16x36	W16x36
fy (Mpa)	250	250
fr (Mpa)	70	70
E (Mpa)	200000	200000
Iy (mm ⁴)	36,61	36,61
Ix (mm ⁴)	11721,50	11721,50
X2 (mm ²)	0,000438	0,000438
Sx (mm ³)	1048772,10	1048772,10
Sy (mm ³)	925869,12	925869,12
Lf (mm)	1921,92	1921,92
Lr (mm)	5562,76	5562,76
L (mm)	3333	3333
Penampang	Lp<L<Lr	Lp<L<Lr
Mp (KN.m)	Kompak	Kompak
Mr (KN.m)	262,19	262,19
Mn (KN.m)	166,65	166,66
Mn pakai (KN.m)	517,88	499,57
0,5 Mn (KN.m)	262,15	262,15
0,9 Mn > Mu	235,571	235,571
Kuat Tarik Tersedia	AMAN	AMAN
P (KN)	106,168	
Ag (mm ²)	6838,696	
T (KN)	1538,707	
T > P (KN)	AMAN	
Kontrol Defleksi		
L (mm)	10000	
Defleksi diizinkan (mm)	27,78	
Defleksi dari SAP	18,50	
	AMAN	

Balok Batang Kombinasi Bahan	B5 5		B6 6		B7 7 dan 8	
	Gravitas&Gempa	Gravitasi	Gravitas&Gempa	Gravitasi	Gravitas&Gempa	Gravitasi
Mu (KN.m)	174,854	121,167	75,967	92,653	290,653	329,792
MA (KN.m)	10,795	22,324	12,286	14,999	8,092	8,262
MB (KN.m)	49,586	83,189	25,355	51,007	162,778	162,101
MC(KN.m)	29,069	36,753	13,639	13,088	129,429	113,631
Cb	2,37	1,81	2,30	2,30	2,10	2,24
Profil	W16x36	W16x36	W14x22	W14x22	W16x50	W16x50
Iy (Mpe)	250	250	250	250	250	250
Ix (Mpa)	70	70	70	70	70	70
E (Mpa)	200000	200000	200000	200000	200000	200000
Iy (mm)	33,61	38,61	27,43	26,42	40,39	40,39
X1 (Mpa)	11721,50	11721,50	13031,55	11100,95	16134,30	16134,30
X2 (1/Mpa) ²	0,000438	0,000438	0,000292	0,000574	0,000116	0,000116
Zx (mm ³)	1048772,10	1048772,10	658759,97	544050,52	1507609,85	1507609,89
Sx (mm ³)	925869,12	925869,12	578463,36	475224,86	1327352,18	1327352,18
Lp (mm)	1921,92	1921,92	1365,57	1315,00	2010,43	2010,43
Lr (mm)	5562,76	5562,76	4087,62	3795,48	6459,19	6459,19
L (mm)	8000	8000	4000	4000	8980	8980
	Lr < L	Lr < L	Lr < L	Lr < L	Lr < L	Lr < L
Penampang	Kompak	Kompak	Kompak	Kompak	Kompak	Kompak
Mp (KN.m)	262,19	262,19	164,69	136,01	370,90	370,90
Mr (KN.m)						
Mn (KN.m)	229,15	179,94	247,57	180,71	326,91	349,05
Mn pakai (KN.m)	206,29	178,63	164,65	136,01	326,01	376,9
0,9.Mn (KN.m)	185,661	160,947	148,221	122,409	294,219	339,21
0,9Mn > Mu	AMAN	AMAN	AMAN	AMAN	AMAN	AMAN
Kuat Tarik Tersedia						
P (KN)	138,392		128,424		243,614	
Ag (mm ²)	6838,696		4167,088		9483,852	
T (KN)	1538,707		942,095		2133,867	
T > P (KN)	AMAN		AMAN		AMAN	
Kontrol Defleksi						
L (mm)	8000		4000		8980	
Defleksi diizinkan (mm)	22,22		11,11		24,94	
Defleksi dari SAP	7,00		1,10		13,00	
	AMAN		AMAN		AMAN	

Balok Batang Kombinasi Beban	B9 9 dan 10	
	Gravitas&Gempa	Gravitasi
Mu (KN m)	226,504	298,842
MA (KN m)	3,956	6,653
MB (KN m)	100,851	130,793
MC (KN m)	53,054	70,311
CS	2,32	2,30
Profil	W16x50	W16x50
fy (Mpa)	250	250
ft (Mpa)	70	70
E (Mpa)	200000	200000
Iy (mm ⁴)	40,39	40,39
Ix (mm ⁴)	16134,30	16134,30
Xc (mm)	0,000748	0,000748
Zx (mm ³)	1507609,89	1507609,89
Sx (mm ²)	1327352,18	1327352,18
Lp (mm)	2010,43	2010,43
Lr (mm)	6459,19	6459,19
L (mm)	8940	8940
	Lr < L	Lr < L
Penampang	Kompak	Kompak
Mp (KN.m)	376,90	376,90
Mtr (KN.m)		
Mdn (KN.m)	350,03	350,03
Mn pakai (KN.m)	356,05	356,05
0,9 Mn (KN.m)	322,245	322,245
0,9 Mn > Mu	AMAN	AMAN
Kuat Tarik Tersedia		
P (KN)	305,495	
Ag (mm ²)	9483,852	
T (KN)	2133,867	
T > P (KN)	AMAN	
Kontrol Defleksi		
L (mm)	8990	
Defleksi diizinkan (mm)	24,94	
Defleksi dari SAP	9,80	
	AMAN	

Balok	B9	
Batang	237 s/d 239	
Kombinasi Beban	Gravitas & Gempa	Gravitas
Mu (KN m)	119,862	187,843
L1A (KN m)	23,601	24,261
MB (KN m)	68,729	68,559
l1/C (KN m)	12,364	16,51
Cb	2,30	2,30
Profil	W16x26	W16x26
Iy (Mpa)	250	250
Iz (Mpa)	70	70
E (Mpa)	200000	200000
Iy (mm)	28,45	28,45
Iz (mm)	10135,65	10135,65
X1 (Mpa)	0,000866	0,000866
X2 (1/Mpa) ²	724309,23	724309,23
Zx (mm ³)	629263,26	629263,26
Sx (mm ³)	1416,15	1416,15
Lr (mm)	4044,07	4044,07
L (mm)	3333	3333
Penampang	LP<Lr	LP<Lr
Mp (KN m)	Kompak	Kompak
Mr (KN m)	181,08	181,08
Mn (KN m)	113,27	113,27
Mn pakai (KN m)	302,72	302,72
C9 Mn (KN.m)	181,08	181,08
0,9 Mn > Mu	162,972	162,972
Kuat Tarik Tersedia	AMAN	AMAN
P (KN)	117,299	
Ag (mm ²)	4954,829	
T (KN)	1114,836	
T > P (KN)	AMAN	
Kontrol Defleksi		
L (mm)	10000	
Defleksi diizinkan (mm)	27,76	
Defleksi dari SAP	16,00	
	AMAN	

Balok	B9	
Batang	360 s/d 363	
Kombinasi Deban	Gravitasi&Gempa	Gravitasi
Mu (KN m)	185,236	202,245
MA (KN m)	36,576	33,391
MB (KN m)	62,885	96,46
MC(KN m)	16,576	33,057
Cd	2,30	2,32
Profil	W15x36	
fy (Mpa)	260	250
fr (Mpa)	70	70
E (Mpa)	200000	200000
Iy (mm)	38,61	38,61
Ix1 (Mpa)	11721,50	11721,50
X2 (1/40ae)2	0,011435	0,000438
Zx (mm)3	1048772,10	1048772,10
Sx (mm)3	925869,12	925869,12
Lp (mm)	1921,92	1921,92
Lr (mm)	5562,76	5562,76
L (mm)	3333	3333
	Lp<L<Lr	Lp<L<Lr
Perampang	Kompak	Kompak
Mp (KN m)	262,19	262,19
Mf (KN m)	169,56	166,66
Mn (KN m)	517,88	521,85
Mn pakai (KN.m)	262,19	262,19
0.9.Mn > Mu	235,971	235,971
	AMAN	AMAN
Kuat Tarik Tersedia		
P (KN)	113,482	
Ag (mm2)	6838,696	
T (KN)	1538,707	
T > P (KN)	AMAN	
Kontrol Defleksi		
L (mm)	10000	
Defleksi diizinkan (mm)	27,78	
Defleksi dari SAP	16,50	
	AMAN	

TABEL DESAIN BALOK TERHADAP LENTUR - PORTAL AS B (ANALISIS 3D)

Balok	B1	B2	B3	B4
Batang	39	40 dan 41	42	44
Kombinasi Beban	Gravitas & Gempa	Gravitas & Gempa	Gravitas & Gempa	Gravitas & Gempa
Mu (KN m)	135,514	82,742	212,907	197,444
MA (KN m)	19,809	11,987	66,396	54,871
MB (KN m)	77,555	27,921	121,54	108,219
MC (KN m)	29,555	14,486	16,607	45,054
CB	2,30	2,30	2,10	2,01
Profil	W16x26	W16x26	W16x36	W16x36
f _y (Mpa)	250	250	250	250
f _r (Mpa)	70	70	70	70
E (Mpa)	200000	200000	200000	200000
I _y (mm ⁴)	29,43	29,45	39,67	39,61
X1 (Mpa)	10135,65	10135,65	11721,50	11721,50
X2 (1/1000)' ²	0,000360	0,000360	0,000438	0,000438
Zx (mm ³)	724306,23	724306,23	864901,45	864901,45
Sx (mm ³)	629263,26	629263,26	773469,42	773469,42
Lp (mm)	1416,15	1416,15	1921,92	1479,37
L _r (mm)	4044,07	4044,07	5562,76	4350,88
L (mm)	4000	4000	8000	8000
Penampang	Lp < L _r	Lp < L _r	L _r < L	L _r < L
Mp (KN m)	Kompak	Kompak	Kompak	Kompak
M _r (KN m)	181,08	181,08	262,19	221,23
M _u (KN m)	113,27	113,27	166,66	144,49
M _n (KN m)	263,13	263,13	436,56	156,79
M _n pakai (KN m)	181,08	181,08	262,19	144,49
0,9 M _n (KN m)	162,972	162,972	235,971	130,641
0,9 M _n > Mu	AMAN	AMAN	AMAN	AMAN
Kuat Tarik Tersejati	102,622	19,437	40,331	146,944
P (KN)	4954,829	5853,696	5853,859	4954,829
Ag (mm ²)	1114,836	1538,707	1323,858	1114,836
T (KN)	AMAN	AMAN	AMAN	AMAN
T > P (KN)	AMAN	AMAN	AMAN	AMAN
Kontrol Defleksi	4000	6000	8000	4000
L (mm)	11,11	22,22	22,22	11,11
Defleksi: diizinkan (mm)	1,08	6,10	3,50	1,20
Defleksi dari SAP	AMAN	AMAN	AMAN	AMAN

Balok	B9	
	43 dan 46	Gravitasi
Batang	Gravitasi & Gempa	Gravitasi
Kombinasi Beban		
Mu (KN.m)	202,306	249,776
MA (KN.m)	6,653	10,745
MB (KN.m)	53,42	118,66
MC (KN.m)	49,03	63,42
Cb	2,30	2,30
Profil	W16x45	W16x45
fy (Mpa)	270	250
ft (Mpa)	70	70
E (Mpa)	200000	200000
fy (mm)	39,88	39,88
X1 (l/4pa)	14617,40	14617,40
X2 (1/4pa) ²	0,000174	0,000174
Zx (mm ³)	1348655,37	1348655,37
Sx (mm ³)	1191330,55	1191330,55
Lp (mm)	1865,14	1865,14
Lr (mm)	6125,12	6125,12
L (mm)	6340	6340
Penampang	Lr < L	Lr < L
Mp (KN.m)	Kompak	Kompak
Mt (KN.m)	337,16	337,16
Idn (KN.m)	295,76	295,76
Idn pakai (K _t .m)	295,76	295,76
0,9 Mn (KN.m)	295,164	295,184
0,9 Mn > Mu	AMAN	AMAN
Kuat Tarik Tersedia		
P (KN)	278,256	
Ag (mm ²)	8580,628	
T (KN)	1930,641	
T > P (KN)	AMAN	
Kontrol Defleksi		
L (mm)	8980	
Defleksi diizinkan (mm)	24,94	
Defleksi dari SAP	3,27	
	AMAN	

Kuat Geser Nominal Balok Portal 1 (Analisis 2D)

Balok	Vu (KN)	d (mm)	h (mm)	tw (mm)	h/tw	Aw (mm ²)	φ.Vn (KN)	Rasio	Chek
1	251,542	463,296	440,131	10,541	41,754	4883,603	659,286	0,382	Aman
2	249,926	463,296	440,131	10,541	41,754	4883,603	659,286	0,379	Aman
3	260,329	463,296	440,131	10,541	41,754	4883,603	659,286	0,395	Aman
4	240,841	459,994	436,994	9,906	44,114	4556,701	615,155	0,392	Aman
5	201,195	459,994	436,994	9,906	44,114	4556,701	615,155	0,327	Aman
6	206,912	459,994	436,994	9,906	44,114	4556,701	615,155	0,336	Aman
7	107,213	402,844	382,702	7,493	51,075	3018,510	407,499	0,263	Aman
8	90,507	402,844	382,702	7,493	51,075	3018,510	407,499	0,222	Aman
9	90,423	402,844	382,702	7,493	51,075	3018,510	407,499	0,222	Aman

Kuat Geser Nominal Balok Portal 2 (Analisis 2D)

Balok	Vu (KN)	d (mm)	h (mm)	tw (mm)	h/tw	Aw (mm ²)	φ.Vn (KN)	Rasio	Chek
1	263,645	459,994	436,994	9,906	44,114	4556,701	615,155	0,429	Aman
2	290,320	462,534	439,407	10,795	40,705	4993,055	674,962	0,431	Aman
3	425,919	467,106	443,751	12,192	36,397	5694,956	768,819	0,554	Aman
4	189,340	458,724	435,788	9,144	47,658	4194,572	566,267	0,334	Aman
5	226,448	459,994	436,994	9,906	44,114	4556,701	615,155	0,368	Aman
6	294,421	463,296	440,131	10,541	41,754	4883,603	659,286	0,447	Aman
7	150,417	398,526	378,600	6,350	59,622	2530,640	341,636	0,440	Aman
8	234,823	403,352	383,184	6,985	54,858	2817,414	380,351	0,617	Aman
9	209,955	402,844	382,702	7,493	51,075	3018,510	407,499	0,515	Aman

Kuat Geser Nominal Balok Portal A (Analisis 2D)

Balok	Vu (KN)	d (mm)	h (mm)	tw (mm)	h/tw	Aw (mm ²)	φ.Vn (KN)	Rasio	Chek
1	220,010	406,654	386,321	7,747	49,867	3150,349	425,297	0,517	Aman
2	149,975	406,654	386,321	7,747	49,867	3150,349	425,297	0,353	Aman
3	95,852	406,654	386,321	7,747	49,867	3150,349	425,297	0,225	Aman
4	52,627	398,526	378,600	6,350	59,622	2530,640	341,636	0,154	Aman
5	51,614	402,844	382,702	7,493	51,075	3018,510	407,499	0,127	Aman
6	49,482	348,996	331,546	5,842	56,752	2038,835	275,243	0,180	Aman
7	145,824	413,004	392,354	9,652	40,650	3986,315	538,152	0,271	Aman
8	110,325	413,004	392,354	9,652	40,650	3986,315	538,152	0,205	Aman

Kuat Geser Nominal Balok Portal B (Analisis 2D)

Balok	Vu (KN)	d (mm)	h (mm)	tw (mm)	h/tw	Aw (mm ²)	φ.Vn (KN)	Rasio	Chek
1	150,792	398,526	378,600	6,350	59,622	2530,640	341,636	0,441	Aman
2	145,494	402,844	382,702	7,493	51,075	3018,510	407,499	0,357	Aman
3	89,716	402,844	382,702	7,493	51,075	3018,510	407,499	0,220	Aman
4	63,488	398,526	378,600	6,350	59,622	2530,640	341,636	0,186	Aman
5	55,738	403,352	383,184	6,985	54,958	2817,414	380,351	0,147	Aman
6	42,023	353,314	335,648	6,477	51,822	2288,415	308,936	0,136	Aman
7	23,502	353,314	335,648	6,477	51,822	2288,415	308,936	0,076	Aman
8	204,289	409,702	389,217	8,763	44,416	3590,219	484,680	0,421	Aman
9	93,194	413,004	392,354	9,652	40,650	3986,315	538,152	0,173	Aman
10	97,291	413,004	392,354	9,652	40,650	3986,315	538,152	0,181	Aman

Kuat Geser Nominal Balok Portal 1 (Analisis 3D)

Balok	Vu (KN)	d (mm)	h (mm)	tw (mm)	h/tw	Aw (mm ²)	φ.Vn (KN)	Rasio	Chek
1	179,711	459,994	436,994	9,906	44,114	4556,701	615,155	0,292	Aman
2	159,379	454,660	431,927	8,001	53,984	7637,735	491,094	0,325	Aman
3	168,125	454,660	431,927	8,001	53,984	3637,735	491,094	0,342	Aman
4	167,778	458,724	435,788	9,144	47,658	4194,572	566,267	0,296	Aman
5	171,649	458,724	435,788	9,144	47,658	4194,572	566,267	0,303	Aman
6	151,895	458,724	435,788	9,144	47,658	4194,572	566,267	0,268	Aman
7	87,725	398,526	378,600	6,350	59,622	2530,640	341,636	0,257	Aman
8	54,938	398,526	378,600	6,350	59,622	2530,640	341,636	0,161	Aman
9	60,570	398,526	378,600	6,350	59,622	2530,640	341,636	0,177	Aman

Kuat Geser Nominal Balok Portal 2 (Analisis 3D)

Balok	Vu (KN)	d (mm)	h (mm)	tw (mm)	h/tw	Aw (mm ²)	φ.Vn (KN)	Rasio	Chek
1	260,934	459,994	436,994	9,906	44,114	4556,701	615,155	0,424	Aman
2	234,286	469,138	445,681	12,573	35,447	5898,472	796,234	0,294	Aman
3	406,372	462,534	439,407	10,795	40,705	4993,055	674,062	0,603	Aman
4	176,554	458,724	435,788	9,144	47,658	4194,572	566,267	0,312	Aman
5	201,011	459,994	436,994	9,906	44,114	4556,701	615,155	0,327	Aman
6	275,373	459,994	436,994	9,906	44,114	4556,701	615,155	0,448	Aman
7	124,433	398,526	378,600	6,350	59,622	2530,640	341,636	0,364	Aman
8	219,784	403,352	383,184	6,985	54,858	2817,414	380,351	0,578	Aman
9	165,602	402,844	382,702	7,493	51,075	3018,510	407,499	0,406	Aman

Kuat Geser Nominal Balok Portal A (Analisis 3D)

Balok	Vu (KN)	d (mm)	h (mm)	tw (mm)	h/tw	Aw (mm ²)	φ.Vn (KN)	Rasio	Chek
1	223,026	403,352	383,184	6,985	54,858	2817,414	380,351	0,586	Aman
2	173,135	403,352	383,184	6,985	54,858	2817,414	380,351	0,455	Aman
3	136,881	402,844	382,702	7,493	51,075	3018,510	407,499	0,336	Aman
4	70,009	398,526	378,600	6,350	59,622	2530,640	341,636	0,205	Aman
5	60,720	398,526	378,600	6,350	59,622	2530,640	341,636	0,178	Aman
6	37,781	348,996	331,546	6,477	56,752	2078,835	275,243	0,137	Aman
7	81,549	413,004	392,354	9,652	40,650	3936,315	538,152	0,152	Aman
8	96,965	413,004	392,354	9,652	40,650	3986,315	538,152	0,180	Aman

Kuat Geser Nominal Balok Portal B (Analisis 3D)

Balok	Vu (KN)	d (mm)	h (mm)	tw (mm)	h/tw	Aw (mm ²)	φ.Vn (KN)	Rasio	Chek
1	138,123	398,526	378,600	6,350	59,622	2530,640	341,636	0,404	Aman
2	136,617	402,844	382,702	7,493	51,075	3018,510	407,499	0,335	Aman
3	68,090	402,844	382,702	7,493	51,075	3018,510	407,499	0,167	Aman
4	26,707	398,526	378,600	6,350	59,622	2530,640	341,636	0,078	Aman
5	47,396	403,352	383,184	6,985	54,858	2817,414	380,351	0,125	Aman
6	24,396	353,314	335,648	6,477	51,822	2288,415	308,936	0,079	Aman
7	51,308	353,314	335,648	6,477	51,822	2288,415	308,936	0,166	Aman
8	199,536	409,702	389,217	8,763	44,416	3550,219	484,680	0,412	Aman
9	73,393	413,004	392,354	9,652	40,650	3936,315	538,152	0,136	Aman
10	87,678	413,004	392,354	9,652	40,650	3986,315	538,152	0,163	Aman

LAMPIRAN E
DESAIN KOLOM

TABEL DESAIN KOLOM TERHADAP GESER (3D)

Kolom K3

Kolom Lantai	Vu,k	d	tw	d/tw	Aw	ϕV_n	Rasio	Chek
	(KN)	(mm)	(mm)		(mm ²)	(KN)		
3	64.726	363.474	12.954	28.059	4708.442	1059.399	0.06	Aman
2	119.628	359.664	12.319	29.196	4430.701	996.908	0.12	Aman
1	184.367	367.792	14.986	24.542	5511.731	1240.139	0.15	Aman

Kolom K4

Kolom Lantai	Vu,k	d	tw	d/tw	Aw	ϕV_n	Rasio	Chek
	(KN)	(mm)	(mm)		(mm ²)	(KN)		
3	49.453	363.474	12.954	28.059	4708.442	1059.399	0.05	Aman
2	119.957	359.664	12.319	29.196	4430.701	996.908	0.12	Aman
1	174.177	386.588	21.082	18.337	8150.048	1833.761	0.09	Aman

Kolom K5

Kolom Lantai	Vu,k	d	tw	d/tw	Aw	ϕV_n	Rasio	Chek
	(KN)	(mm)	(mm)		(mm ²)	(KN)		
3	61.040	363.474	12.954	28.059	4708.442	1059.399	0.06	Aman
2	131.234	359.664	12.319	29.196	4430.701	996.908	0.13	Aman
1	178.913	367.792	14.986	24.542	5511.731	1240.139	0.14	Aman

Kolom K6

Kolom Lantai	Vu,k	d	tw	d/tw	Aw	ϕV_n	Rasio	Chek
	(KN)	(mm)	(mm)		(mm ²)	(KN)		
3	48.890	363.474	12.954	28.059	4708.442	1059.399	0.05	Aman
2	114.130	359.664	12.319	29.196	4430.701	996.908	0.11	Aman
1	169.303	386.588	21.082	18.337	8150.048	1833.761	0.09	Aman

TABEL DESAIN KOLOM TERHADAP GESER (2D)

Kolom K1

Kolom Lantai	Vu,k	d	tw	d/tw	Aw	ϕV_n	Rasio	Chek
	(KN)	(mm)	(mm)		(mm ²)	(KN)		
3	86.618	363.474	12.954	28.059	4708.442	1059.399	0.08	Aman
2	136.047	359.664	12.319	29.196	4430.701	996.908	0.14	Aman
1	372.184	367.792	14.986	24.542	5511.731	1240.139	0.30	Aman

Kolom K2

Kolom Lantai	Vu,k	d	tw	d/tw	Aw	ϕV_n	Rasio	Chek
	(KN)	(mm)	(mm)		(mm ²)	(KN)		
3	94.581	363.474	12.954	28.059	4708.442	1059.399	0.09	Aman
2	149.047	359.664	12.319	29.196	4430.701	996.908	0.15	Aman
1	410.511	386.588	21.082	18.337	8150.048	1833.761	0.22	Aman

Kolom K3

Kolom Lantai	Vu,k	d	tw	d/tw	Aw	ϕV_n	Rasio	Chek
	(KN)	(mm)	(mm)		(mm ²)	(KN)		
3	120.745	363.474	12.954	28.059	4708.442	1059.399	0.11	Aman
2	277.197	359.664	12.319	29.196	4430.701	996.908	0.28	Aman
1	303.747	367.792	14.986	24.542	5511.731	1240.139	0.24	Aman

Kolom K4

Kolom Lantai	Vu,k	d	tw	d/tw	Aw	ϕV_n	Rasio	Chek
	(KN)	(mm)	(mm)		(mm ²)	(KN)		
3	49.453	363.474	12.954	28.059	4708.442	1059.399	0.05	Aman
2	119.957	359.664	12.319	29.196	4430.701	996.908	0.12	Aman
1	174.177	386.588	21.082	18.337	8150.048	1833.761	0.09	Aman