

**Pengujian Efisiensi Bentuk Lemah
Studi Kasus pada Saham-Saham Sektor Teknologi
Di Bursa Efek Jakarta (BEJ)
Periode 2000-2003**

SKRIPSI

**Ditulis dan diajukan untuk memenuhi syarat ujian akhir guna
Memperoleh gelar Sarjana Strata-1 di Program Studi Manajemen,
Fakultas Ekonomi, Universitas Islam Indonesia**

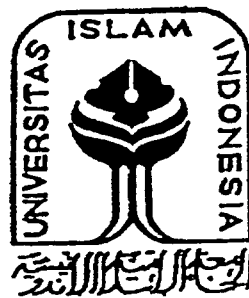

oleh:

**Nama : Diah Eko Ratnasari
Nomor Mahasiswa : 01311451
Program Studi : Manajemen
Bidang Konsentrasi : Keuangan**

**UNIVERSITAS ISLAM INDONESIA
FAKULTAS EKONOMI
YOGYAKARTA
2004**

**Pengujian Efisiensi Bentuk Lemah
Studi Kasus pada Saham-Saham Sektor Teknologi
Di Bursa Efek Jakarta (BEJ)
Periode 2000-2003**

SKRIPSI

**Ditulis dan diajukan untuk memenuhi syarat ujian akhir guna
Memperoleh gelar Sarjana Strata-1 di Program Studi Manajemen,
Fakultas Ekonomi, Universitas Islam Indonesia**

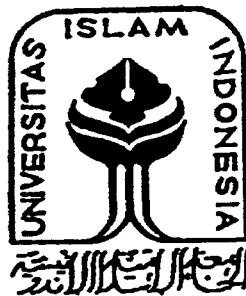

oleh:

**Nama : Diah Eko Ratnasari
Nomor Mahasiswa : 01311451
Program Studi : Manajemen
Bidang Konsentrasi : Keuangan**

**UNIVERSITAS ISLAM INDONESIA
FAKULTAS EKONOMI
YOGYAKARTA
2004**

PERNYATAAN BEBAS PLAGIARISME

“Dengan ini saya menyatakan bahwa dalam skripsi ini tidak terdapat karya yang pernah diajukan untuk memperoleh gelar kesarjanaan di suatu perguruan tinggi, dan sepanjang sepengetahuan saya juga tidak terdapat karya atau pendapat yang pernah ditulis atau diterbitkan oleh orang lain, kecuali yang secara tertulis diacu dalam naskah ini dan disebutkan dalam referensi. Dan apabila dikemudian hari terbukti bahwa pernyataan ini tidak benar maka saya sanggup menerima hukuman / sanksi apapun sesuai peraturan yang berlaku.”

Yogyakarta, Januari 2005

Penulis,

Diah Eko Ratnasari

**Pengujian Efisiensi Bentuk Lemah
Studi Kasus pada Saham-Saham Sektor Teknologi
Di Bursa Efek Jakarta (BEJ)
Periode 2000-2003**

Hasil Penelitian

Diajukan Oleh:

Nama : Diah Eko Ratnasari
Nomor Mahasiswa : 01311451
Program Studi : Manajemen

Telah Disetujui oleh Dosen Pembimbing

Pada Tanggal

Dosen Pembimbing,

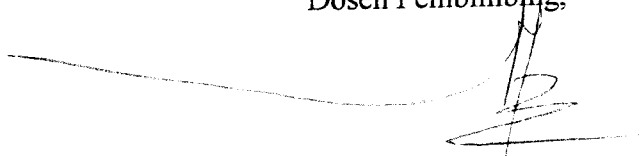

(Dra, Nur Fauziah, MM)

BERITA ACARA UJIAN SKRIPSI

SKRIPSI BERJUDUL

**PENGUJIAN EFISIENSI BENTUK LEMAH STUDI KASUS PADA SAHAM-SAHAM
SEKTOR TEKHNOLOGI DI BURSA EFEK JAKARTA (BEJ) PERIODE 2000 -
2003**

**Disusun Oleh: DIAH EKO RATNASARI
Nomor mahasiswa: 01311451**

Telah dipertahankan di depan Tim Penguji dan dinyatakan **LULUS**
Pada tanggal : 17 Februari 2005

Penguji/Pemb. Skripsi: Dra. Nurfauziah, MM

Penguji : Drs. Bachruddin, M.Si

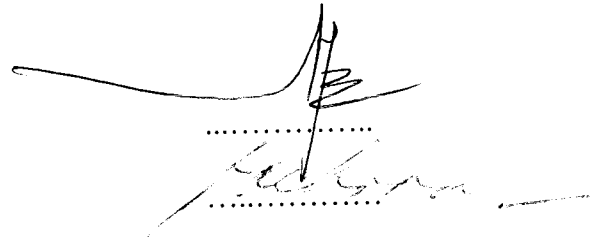

Mengetahui

Dekan Fakultas Ekonomi
Universitas Islam Indonesia



Drs. Suwarsono, MA

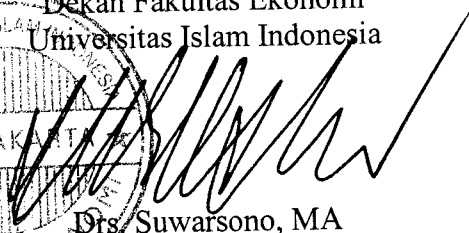

HALAMAN PERSEMBAHAN

Papa dan Mama

Terima kasih atas cinta dan pengorbanan yang tiada akhir

Saudaraku tersayang, Taufik dan Firdha

Serta orang-orang tersayangku di Jogja

“Mutiara Pencerahan”

“..Tuhanmu akan memberikan kepadamu sesuatu yang membikin kamu puas”

(Q.S. Ad Dhuhaa : 5)

“..Cukuplah Allah sebagai pelindungmu,

Dialah yang memperkuat kamu dengan pertolonganNya maupun dengan dukungan orang mukmin”

(Q.S Al-Anfal : 62)

*“..Sebutlah nama Tuhanmu pada pagi dan petang hari,
Pada sebagian malam bersujudlah kamu kepadaNya, bertasbihlah
Memujinya pada malam hari yang panjang”*

(Q.S Al-Insan : 25-26)

“Ngelmu iku kelakone kanthi laku,

lekase lawan kas,

tegese kas nyantosani,

setya budaya pangekase dur angkara”

Ilmu yang sejati hanya dapat dicapai dengan laku dan hanya berguna apabila diterjemahkan dalam kehidupan sehari-hari. Perilaku dengan kesungguhan hati akan menghasilkan kepuasan batin. Demikian kau akan memperoleh kesadaran yang dapat mengikis keangkuhanmu.

(Sri Paduka Mangkunegoro IV)

KATA PENGANTAR

Assalamu'alaikum wr.wb.,

Alhamdulillahiraabbil'alamin, segala puji dan syukur penulis haturkan hanya kepada Allah SWT, yang senantiasa memberikan rahmat serta hidayahnya sehingga penulis dapat menyelesaikan penulisan skripsi yang berjudul "Pengujian Efisiensi Bentuk Lemah Studi Kasus pada Saham-Saham Sektor Teknologi Di Bursa Efek Jakarta (BEJ) Periode 2000-2003".

Skripsi ini disusun dengan tujuan untuk menguji ada tidaknya pengaruh perubahan harga pada saham-saham sektor teknologi pada waktu lalu di BEJ dengan perubahan harga saham sektor teknologi di waktu sekarang. Apabila perubahan harga saham yang terjadi pada waktu lalu di BEJ tidak ada pengaruhnya dengan perubahan harga saham di waktu sekarang pada periode pengamatan tahun 2000 - 2003, maka BEJ sudah efisien dalam bentuk lemah (*weak form efficiency*). Serta untuk menguji apakah perubahan harga pada saham-saham sektor teknologi yang terjadi di BEJ bersifat tidak beraturan (*random*). Apabila perubahan harga pada saham-saham sektor teknologi bersifat tidak beraturan (*random*), maka BEJ sudah efisien dalam bentuk lemah (*weak form efficiency*).

Penulis menyadari bahwa dalam penulisannya, skripsi ini masih jauh dari sempurna, karena kesempurnaan itu mutlak milik Allah semata. Dalam keterbatasan serta kedangkalan ilmu sebagai manusia penulis sangat mengharapkan masukan dari

berbagai pihak, baik saran maupun kritik yang sifatnya membangun untuk hasil yang lebih baik di kemudian hari.

Bantuan dan dukungan yang tak terhingga dari berbagai pihak dalam penulisan skripsi ini merupakan salah satu kemudahan yang sangat penulis syukuri, oleh karenanya ucapan terima kasih yang dalam penulis sampaikan kepada:

1. Allah swt, yang telah memberikan kesehatan hingga detik ini, untuk dapat selalu menyembah dan mengagungkan nama-mu, serta untuk mengucapkan syukur atas rahmat, nikmat, cobaan, dan teguran yang telah engkau berikan selama ini. Terima kasih ya Allah..
2. Bpk. Drs. Suwarsono Muhammad, MA selaku Dekan Fakultas Ekonomi Universitas Islam Indonesia.
3. Ibu Dra. Nur Fauziah, MM selaku Ketua Jurusan Program Studi Manajemen Fakultas Ekonomi Universitas Islam Indonesia, dan selaku Dosen Pembimbing Skripsi yang telah mencurahkan waktu dan perhatiannya dengan kesabaran membimbing dan mengarahkan penulis selama proses penyusunan skripsi.
4. Bpk. Drs. Sumadi, M.Si. selaku Dosen Pembimbing Akademik Fakultas Ekonomi Universitas Islam Indonesia.
5. Bpk. Sukasno Wibowo (Alm) dan Ibunda Sumiyati yang tersayang dan terhormat, yang telah melahirkanku dan membimbingku di jalan allah, yang telah mencurahkan segenap perhatian, kasih sayang dan cinta serta pengorbanan yang tak ternilai. Kalian telah memberikan arti hidup yang sebenarnya. Terima kasih pah mah..

6. Adik-adikku tersayang, Taufik n' Firdha walaupun kita sering berantem tapi mungkin itu yang dapat menghangatkan persaudaraan kita. Keceriaan kalian adalah kebahagiaanku. Moga cita-cita kalian dapat terwujud. So..belajar yang rajin yach.
7. Keluarga besar di Cilacap beserta keluarga besar Soegiyanto Budiarmaja, yang telah banyak membantu baik moril maupun materiil, perhatian serta kasih sayang yang tiada henti, semoga kesejahteraan dan kedamaian selalu menyertai kita semua. Amin...
8. Sekolahku dan guru-guruku yang telah mendidik dan membimbingku dari TK sampai aku sarjana. TK Bhayangkari tempatku bermain dan bernyanyi, SDN Sidanegara 09 Clp, SLTPN 6 Clp, SMUN 2 Clp, Universitas Islam Indonesia. Tempatku menuntut ilmu, belajar bersosialisasi dan berorganisasi. "*Matur sembah nuwun*"
9. Arga_qu, yang sabar banget ngadepin aku yang super egois, yang selalu manjain aku dalam segala hal, yang selalu nasehatin aku saat aku khilaf, yang selalu ada untuk menghiburku dalam segala suasana, n' Starlet R8870DB yang setia mengantar kita kemanapun kita mau walaupun kadang rewel tapi kita tetep *enjoy* lho.. poko'e *Thanks very much de'*
10. *My Friend* di Semarang, Radit, Bobby, Arko n' Veva thanks ya udah nemenin jalan-jalan muter-muter Semarang. Buat ve sekeluarga makasih banyak atas tempat bermalamnya, ve..k-mu temen terame yang pernah aku temui. *imissu*.

11. Temen-temen KKN SL-21, Deden, arul, mukhlis, mas yanto, om ulin, iman, devi, siska, sita, mba tri, 'n asti, pha kabar semua, ko kita ga pernah kontak lagi sich.. rencana jalan-jalannya belum jadi lho..Seluruh warga dusun Ngangkrik sleman, yang sudah menerima dan membimbing kami selama kkn, terima kasih..banyak pelajaran yang dapat kami peroleh disana.
12. Temen-temen KSPM angk V, uli, intan, desy, irma, irmaz, diana, indra, irwan, judo, 'n semua yang ga bisa disebutin satu-satu, banyak suka duka yang kita lalui, banyak ilmu yang dapat aku peroleh dari kalian, banyak pengalaman yang belum pernah aku alami sebelumnya terutama saat kita ke BES. Kompak always!
13. Kontrakan f.21, sendi, kholis, bastian, 'n nduk yang telah menyisikan banyak kenangan manis untukku. Sendi, yang setia ndengerin semua keluh kesahku, yang selalu support aku n' telah banyak berkorban untukku, ayu yakin suatu saat kamu mendapatkan orang yang tepat sebagai pendamping hidupmu.
14. Sobatku, Nantri, Erry n' Desy apa sih yang ga kita bicarain, dari gossip, sampe soal hati, kalian yang selalu jadi tempat curhatku, canda, tawa, bahkan tangis sering mengisi persahabatan kita. Kalian benar-benar berarti, iloveu so much..
15. *My Bed Room* yang jadi saksi bisu semua aktivitasku sehari-hari. Tempatku berinspirasi, berfikir, tertawa dan menangis. Radio Tape n' Windows Media Player yang selalu membuatku bemyanyi, komputerku yang banyak membantu nyelesin tugas kuliah plus skripsi ini, R4451EK yang setia nganterin aku, en semua barang-barang tersayangku. Aku akan selalu menjagamu.

DAFTAR ISI

	Halaman
Halaman Judul	i
Halaman Pernyataan Bebas Plagiarisme	ii
Halaman Pengesahan	iii
Halaman Persembahan	iv
Mutiara Pencerahan	v
Kata Pengantar	vi
Daftar Isi	xi
Daftar Tabel	xiv
Daftar Gambar	xv
Daftar Lampiran	xvi
Abstrak	xvii
BAB I PENDAHULUAN	
1.1 Latar Belakang Masalah	1
1.2 Rumusan Masalah Penelitian	5
1.3 Batasan Masalah	5
1.4 Tujuan Penelitian	5
1.5 Manfaat Penelitian	6
BAB II KAJIAN PUSTAKA	
2.1 Organisasi dan Struktur Pasar Modal Indonesia	
2.1.1 Jenis-jenis Pasar di Dalam Pasar Modal	9
2.1.2 Para Pelaku di Dalam Pasar Modal	11
2.2 Pasar Modal Efisien	
2.2.1 Definisi Pasar Modal Yang Efisien	12

2.2.2 Alasan Pasar Modal Efisien	13
2.2.3 Bentuk-Bentuk Efisiensi Pasar	15
2.2.4 Pengujian Empiris Terhadap Efisiensi Pasar Modal	19
2.2.5 Konsepsi Yang Salah Mengenai Hipotesis Pasar Efisien	24
2.3 Kajian Penelitian Terdahulu	25
2.4 Formulasi Hipotesis	27

BAB III METODE PENELITIAN

3.1 Gambaran Umum Pasar Modal Dan Bursa Efek	28
3.2 Populasi Dan Sampel	29
3.3 Variabel Penelitian.....	30
3.4 Teknik Pengumpulan Data	30
3.5 Prosedur Penelitian	31
3.6 Langkah-Langkah Analisis	32
3.7 Pengujian Hipotesis	
3.7.1 Uji Regresi Linear	32
3.7.2 Tes Runtun (<i>runs test</i>)	33

BAB IV ANALISIS DAN PEMBAHASAN

4.1 Deskripsi Penelitian	
4.1.1 Persiapan Awal Penelitian	37
4.1.2 Proses Penelitian	37
4.2 Analisis Data	
4.2.1 Pengukuran Return	38
4.2.2 Analisis Deskriptif	40
4.3 Pengujian Hipotesis	
4.3.1 Pengujian Hipotesis Pertama	40
4.3.2 Pengujian Hipotesis Kedua	44

BAB V PENUTUP	
5.1 Kesimpulan	47
5.2 Keterbatasan Penelitian dan Rekomendasi Penelitian Berikutnya	48
5.3 Implikasi	49
DAFTAR PUSTAKA	
LAMPIRAN	

DAFTAR TABEL

Tabel	Hal
4.1 Hasil Uji Regresi <i>Prob-Value</i> Q Perubahan Harga Saham	41
4.2 Hasil Runs Test <i>Prob-Value</i> Z Perubahan Harga Saham	44

DAFTAR GAMBAR

Gambar	Hal
2.1 Proses Penawaran Publik di Pasar Perdana	10
2.2 Tingkatan Kumulatif dari Ketiga bentuk pasar efisien	17
(efisiensi pasar secara informasi)	
2.3 Tingkatan Kumulatif dari Keempat bentuk pasar efisien	19
(efisiensi pasar secara keputusan)	
4.1 Grafik perubahan harga saham	39

DAFTAR LAMPIRAN

Lampiran I : Daftar Perusahaan Sampel (perusahaan sektor teknologi yang aktif di
perdagangan pada Bursa Efek Jakarta)

Lampiran II : Hasil Uji Regresi Linear

Lampiran III : Hasil Runs Test

Lampiran IV : Data Harga Saham Perusahaan Sampel Periode 2000-2003

ABSTRAK

Pengujian efisiensi bentuk lemah ini dilakukan pada saham-saham perusahaan sektor teknologi yang sahamnya selalu aktif diperdagangkan pada Bursa Efek Jakarta (BEJ), sehingga setiap perusahaan sampel akan memiliki *return* saham harian yang digunakan sebagai variabel penelitian. Penelitian ini diharapkan dapat memberi manfaat bagi pelaku pasar modal sehingga dapat membantu mereka untuk mengembangkan investasinya secara optimal melalui strategi dan analisis investasi yang sesuai dengan keadaan pasar.

Penelitian ini merupakan hasil replikasi dari penelitian Lisa Lubrina (2004). Perbedaan penelitian ini dari penelitian sebelumnya adalah, dalam penelitian ini menggunakan data *return* harian serta disertai grafik perubahan harga saham. Identifikasi penelitian ini menggunakan analisis regresi linear dan tes runtun (*runs test*).

Penelitian ini memberikan hasil bahwa pasar modal Indonesia telah efisien dalam bentuk lemah sesuai dengan syarat efisiensi pasar, yaitu bahwa perubahan harga saham pada waktu lalu tidak berpengaruh terhadap perubahan harga saham pada saat ini dan membuktikan bahwa perubahan harga saham bersifat tidak beraturan (*random*).

Kata Kunci : efisiensi pasar, *return*, regresi linear, runs test.

BAB I PENDAHULUAN

1. Latar Belakang Masalah

Perkembangan pasar modal Indonesia terakhir ini sangat menggembirakan. Kemampuannya dalam melakukan intermediasi dana meningkat dengan pesat. Krisis ekonomi dan moneter yang melanda kita pada pertengahan tahun 1997 dapat dijadikan pelajaran yang berharga dalam menyiapkan pasar yang semakin terbuka. Dengan adanya pasar modal maka akan semakin banyak perusahaan yang go-public. Keberhasilan suatu perusahaan dapat dilihat dari nilai perusahaan. Pada perusahaan yang go-public, nilai perusahaan dapat dilihat dari harga sahamnya. Harga saham mencerminkan nilai perusahaan bila pasar modal dalam keadaan efisien.

Pasar modal merupakan salah satu bagian dari pasar *financial* yang menjalankan dua fungsi dalam pelaksanaannya yaitu, fungsi ekonomi dan fungsi keuangan. Pasar modal dalam menjalankan fungsi ekonomi dengan mengalokasikan dana secara efisien dari pihak yang memiliki dana kepada pihak yang membutuhkan dana, sehingga pihak yang kelebihan dana dapat menginvestasikan dananya dengan harapan akan memperoleh imbalan dari penyerahan dananya tersebut, sedangkan pihak yang memerlukan dana dapat melakukan investasi tanpa harus menunggu tersedianya dana dari hasil operasi perusahaan. Fungsi keuangan pasar modal memberikan kemungkinan bagi pemilik dana untuk memperoleh imbalan atas investasi yang dilakukannya, sesuai dengan pilihan investasi dan tingkat resiko yang

ditanggung oleh investor. Fungsi yang terakhir sesuai dengan salah satu teori investasi yang mengatakan bahwa hubungan antara imbalan (*return*) adalah berbanding lurus atau berhubungan positif dengan tingkat resiko (*risk*) yang ditanggung.

Pasar modal dikatakan efisien dalam alokasi jika dana dari pihak investor dialokasikan kepada pihak yang benar-benar membutuhkan modal dan menggunakan modal tersebut ke dalam hal-hal yang produktif yang dapat memberikan keuntungan yang tinggi. Pasar modal yang efisien menjadikan harga saham cenderung wajar dan harga saham benar-benar mencerminkan nilai saham (perusahaan) yang bersangkutan hingga tidak ada harga saham yang *overvalue* atau *undervalue*. Bila benar harga-harga saham di pasar modal Indonesia *overvalue* atau *undervalue* berarti pasar modal di Indonesia belumlah efisien, selain itu pasar modal yang efisien dimana seluruh informasi yang relevan diterima oleh investor dan informasinya telah diprediksikan ke dalam saham.

Untuk menciptakan atau mendorong agar pasar modal Indonesia dapat berkembang mengarah pada iklim pasar yang efisien, maka pemerintah perlu membuat atau mengeluarkan peraturan-peraturan yang mendukungnya. Peraturan-peraturan itu berupa paket deregulasi dan kebijaksanaan-kebijaksanaan yang sudah dilaksanakan, termasuk mengeluarkan tatanan dan perangkathukum yang menjadi rambu-rambu dan petunjuk bagi pelaku pasar dalam melaksanakan aktifitasnya di pasar modal seperti UU No.8 Th. 1995 tentang pasar modal.

Maka tidaklah mengherankan mengapa topik pasar yang efisien menjadi penting untuk dibahas, karena seorang investor yang ingin melakukan investasi di pasar modal menginginkan agar dana yang mereka tanamkan dalam bentuk pembelian sekuritas yang tersedia dapat memberikan hasil atau keuntungan yang tinggi, oleh karena itu investor sangat membutuhkan sekali sebuah harga sekuritas yang benar sehingga mereka tidak akan mengalami kerugian apabila berinvestasi di pasar modal tersebut.

Sesuai dengan konsep dasar efisiensi dan kondisi ideal pasar efisien secara informasional menurut Fama (1970) yang dikutip dari (Jogiyanto:2000), diklasifikasikan ke dalam tiga bentuk tingkatan kumulatif yang diringkas dalam hipotesis pasar yang efisien, yaitu:

- Hipotesis pasar yang efisien dalam bentuk lemah
Menyatakan bahwa informasi pergerakan harga dimasa lalu sepenuhnya digambarkan dalam harga pasar saat ini.
- Hipotesis pasar yang efisien dalam bentuk setengah kuat
Menyatakan bahwa harga pasar saat ini menggambarkan semua informasi yang tersedia bagi umum atau informasi yang dipublikasikan.
- Hipotesis pasar yang efisien dalam bentuk kuat
Menyatakan bahwa harga pasar saat ini menggambarkan seluruh informasi yang ada, baik informasi yang dipublikasikan maupun informasi yang bersifat privat.

Penelitian ini untuk menguji apakah pasar modal Inonesia pada tahun 2000 - 2003 telah efisien dalam bentuk lemah khususnya pada sektor tekhnologi. Penulis memilih pengujian efisiensi pasar yang paling sederhana yaitu pengujian efisiensi bentuk lemah karena pada negara-negara berkembang seperti Indonesia sangat memerlukan informasi pergerakan harga saham yang dapat membantu investor, pialang, dan emiten untuk mengembangkan investasinya secara optimal melalui strategi dan analisis investasi yang sesuai dengan keadaan pasar. Serta berdasarkan kenyataan tentang masih banyaknya perbedaan hasil penelitian antara peneliti satu dengan yang lainnya dalam menyimpulkan tingkat efisiensi pasar modal di Indonesia. Dipilihnya sektor tekhnologi karena pada sektor ini banyak diminati oleh para investor, serta memiliki prospek yang sangat bagus. Pada era globalisasi serta perdagangan bebas seperti saat ini setiap negara dituntut untuk dapat bersaing dalam hal kemajuan tekhnologi. Dan dapat diramalkan nilai pasar pada sektor ini akan terus mengalami peningkatan setiap tahunnya. Berdasarkan latar belakang diatas maka penulis tertarik untuk memilih judul:

“PENGUJIAN EFISIENSI BENTUK LEMAH STUDI KASUS PADA SAHAM-SAHAM PERUSAHAAN BERBASIS TEKNOLOGI DI BURSA EFEK JAKARTA PERIODE 2000 – 2003”

1.2 Perumusan Masalah

Berdasarkan pada uraian latar belakang di atas, masalah utama yang akan diteliti adalah: Sudahkah Bursa Efek Jakarta (BEJ) efisien dalam bentuk lemah, terutama untuk saham-saham sektor teknologi tahun 2000 -2003 masalah utama penelitian ini dapat terjawab jika turut mempertimbangkan sub masalah berikut ini:

1. Apakah harga saham pasar modal Indonesia mencerminkan dengan cepat dan tepat harga saham pada masa yang lalu?
2. Apakah perubahan harga saham yang terjadi di BEJ bersifat tidak beraturan (*random*)?

1.3 Batasan Masalah

1. Saham-saham yang terdapat didalam penelitian ini merupakan saham-saham berbasis teknologi yang selalu aktif diperdagangkan pada Bursa Efek Jakarta (BEJ).
2. Periode yang digunakan dalam penelitian ini tahun 2000-2003.
3. Indeks harga yang digunakan adalah Indeks Harga Harian.

1.4 Tujuan Penelitian

Tujuan dari penelitian ini adalah:

1. Untuk menguji apakah perubahan harga pada saham-saham sektor teknologi pada waktu lalu di BEJ tidak ada pengaruhnya dengan perubahan harga saham sektor teknologi diwaktu sekarang. Apabila perubahan harga saham yang terjadi

pada waktu lalu di BEJ tidak ada pengaruhnya dengan perubahan harga saham diwaktu sekarang pada periode pengamatan tahun 2000 - 2003, maka BEJ sudah efisien dalam bentuk lemah (*weak form efficiency*).

2. Untuk menguji apakah perubahan harga pada saham-saham sektor teknologi yang terjadi di BEJ bersifat tidak beraturan (*random*). Apabila perubahan harga pada saham-saham sektor teknologi bersifat tidak beraturan (*random*), maka BEJ sudah efisien dalam bentuk lemah (*weak form efficiency*).

1.5 Manfaat Penelitian

Penelitian ini diharapkan akan memberi manfaat:

1. Bagi pelaku pasar modal di Bursa Efek Jakarta (BEJ) seperti investor, pialang, penjamin dan emiten, penelitian ini dapat memberikan informasi mengenai efisiensi pasar modal di BEJ sehingga dapat membantu mereka untuk mengembangkan investasinya secara optimal melalui strategi dan analisis investasi yang sesuai dengan keadaan pasar.
2. Bagi masyarakat umum sebagai calon investor dapat mendorong mereka untuk berinvestasi di pasar modal karena masyarakat percaya bahwa pasar modal tersebut sudah efisien.
3. Bagi para akademisi, penelitian ini diharapkan akan menambah wawasan mengenai penerapan hipotesis pasar yang efisien di BEJ, serta sebagai referensi dalam penelitian-penelitian sejenis dimasa yang akan datang.

4. Bagi penulis, dapat menambah wawasan tentang efisiensi pasar modal terutama di BEJ, juga sebagai bentuk penerapan teori yang diperoleh selama menempuh pendidikan S-1 di fakultas ekonomi UII.

1.6 Sistematik Penulisan

Sistematika pembahasan dibagi menjadi lima bab, yaitu:

Bab I : Pendahuluan

Dalam bab ini diuraikan mengenai latar belakang masalah penelitian, perumusan masalah, tujuan penelitian, manfaat penelitian, dan sistematika pembahasan.

Bab II : Kajian Pustaka

Pada bab ini akan dibagi menjadi tiga bagian. Bagian pertama akan membahas tentang organisasi dan struktur pasar modal Indonesia.

Bagian kedua akan membahas tentang teori pasar modal yang efisien. Meliputi definisi pasar modal yang efisien, alasan pasar modal efisien, bentuk pasar modal yang efisien dan pengujian terhadap efisiensi pasar modal.

Sedangkan bagian ketiga berisi tentang kajian penelitian terdahulu, serta formulasi hipotesis yang didasarkan pada teori

Bab III : Metode Penelitian

Menguraikan tentang populasi dan penentuan sample penelitian, sumber data dan teknik pengumpulan data, definisi dan pengukuran variabel

BAB II

KAJIAN PUSTAKA

2.1. Organisasi dan Struktur Pasar Modal Indonesia

2.1.1. Jenis-Jenis Pasar Di Dalam Pasar Modal

Pasar modal berperan penting bagi pembangunan ekonomi sebagai salah satu sumber pembiayaan eksternal bagi dunia usaha dan wahana investasi bagi masyarakat. Di dalam pasar modal mencakup pasar perdana dan pasar sekunder. Pasar perdana adalah pasar dimana untuk pertama kalinya efek baru dijual kepada investor oleh perusahaan yang mengeluarkan efek tersebut. Jika perusahaan menjual efek untuk pertama kalinya maka penjualan ini disebut sebagai penawaran perdana (*Initial Public Offering* atau *Going Public*)

Perusahaan yang akan melakukan penawaran publik (*public offering*) di Indonesia pada dasarnya melalui prosedur yang ditunjukkan Gambar 2.1. Pertama, perusahaan (*emiten*) tersebut, dengan bantuan profesional dan lembaga pendukung pasar modal, akan menyiapkan berbagai dokumentasi serta persyaratan yang diperlukan untuk *go public*. Salah satu profesional pendukung pasar modal yang memegang peran penting adalah *underwriter*. *Underwriter* membantu perusahaan mulai dari menentukan harga perdana hingga memasarkan efek yang ditawarkan kepada calon investor. Profesional dan lembaga-lembaga yang terkait dengan penawaran publik antara lain adalah akuntan publik, notaris, konsultan hukum, *Trustee* (untuk penjualan obligasi), dan *guarantor*.

Gambar 2.1 Proses Penawaran Publik di Pasar Perdana

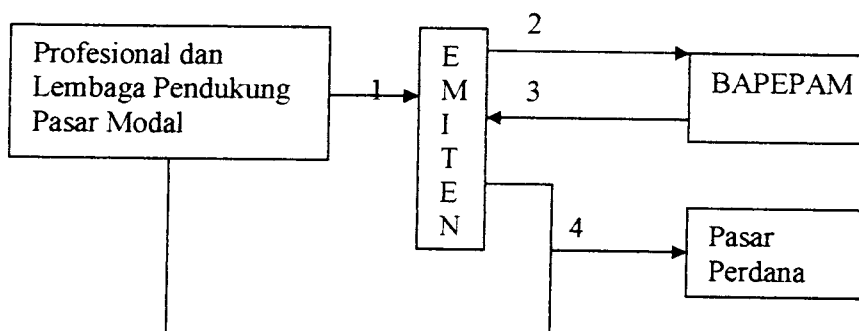

1. Profesional dan lembaga pendukung pasar modal membantu emiten dalam menyiapkan dokumen penawaran publik.
2. Emiten menyerahkan Pernyataan Pendaftaran kepada BAPEPAM.
3. Pernyataan Pendaftaran dinyatakan efektif oleh BAPEPAM.
4. Emiten dan lembaga dan professional pendukung melakukan penawaran publik pada pasar perdana.

Sumber: Jakarta Stock Exchange, Fact Book 1996.

Pasar perdana tidak akan berfungsi dengan baik tanpa adanya pasar sekunder. Pasar sekunder memberikan likuiditas bagi investor untuk melakukan jual beli saham kapanpun sesuai dengan keinginan investor. Di Indonesia pasar sekunder dilakukan di Bursa Efek Jakarta (BEJ) dan Bursa Efek Surabaya (BES). Kegiatan transaksi jual beli di pasar sekunder tidak mempengaruhi perusahaan yang mengeluarkan efek karena perusahaan tersebut tidak menerima kas dari transaksi tersebut.

2.1.2. Para Pelaku Di Dalam Pasar Modal

Banyak lembaga yang kegiatannya berhubungan dengan pasar modal. Tanpa adanya lembaga-lembaga tersebut pasar modal tidak dapat berkembang dan sebaliknya tanpa pasar modal berbagai lembaga itu tidak akan dapat tumbuh dengan baik. Para pelaku dalam pasar modal dikategorikan menjadi 3 kelompok, yaitu:

- 1) Badan yang bertugas mengawasi pasar modal. Di Indonesia tanggung jawab ini dipegang oleh Bapepam. Menurut Undang-Undang No.8 Tahun 1995 tentang Pasar Modal, pada dasarnya Bapepam mempunyai wewenang untuk menginterpretasikan hukum dan perundang-undangan mengenai berbagai hal dalam wilayah yurisdiksinya, dan untuk membuat peraturan-peraturan dan keputusan-keputusan independent untuk pelaksanaannya (Herianto, 1998).
- 2) Pihak-pihak yang secara langsung terlibat dengan perdagangan efek seperti emiten, investor, badan pengelola bursa, dan perantara / pedagang efek. Emiten adalah perusahaan yang memperoleh dana melalui pasar modal dengan menjual sekuritas / efek kepada masyarakat luas. Investor adalah orang yang memasok dana ke pasar modal sehingga kemajuan suatu pasar modal sangat tergantung pada peran yang dipakai investor. Dan perantara perdagangan efek atau Broker adalah pihak yang membeli dan menjual efek di bursa atas permintaan investor.

- 3) Pihak-pihak yang mendukung kepastian, kelancaran, dan ketertiban pasar modal seperti Kustodian Sentral Efek Indonesia (KSEI) dan Kliring Penjamin Efek Indonesia (KPEI) dan wali amanat (*Trustee*).

2.2. Pasar Modal yang Efisien

2.2.1. Definisi Pasar Modal yang Efisien

Pengertian pasar modal efisien yang diterima secara luas adalah pasar modal yang apabila terdapat informasi baru, maka informasi tersebut tersebar luas, cepat dan mudah didapat secara murah oleh investor. Informasi ini meliputi hal yang diketahui dan relevan untuk mempertimbangkan harga saham dan tercermin secara cepat dalam harga saham. Menurut Yong (1997), istilah pasar efisien pertama kali digunakan dalam konteks pasar sekuritas oleh Fama, Fisher, Jensen dan Roll (1969). Mereka menyatakan bahwa pasar efisien adalah pasar yang membuat penyesuaian secara cepat terhadap informasi baru yang muncul. Fama (1976) memperbaiki definisinya mengenai pasar efisien dengan mengatakan bahwa pasar efisien merupakan pasar yang menggunakan semua informasi secara benar. Perubahan harga secara acak maksudnya perubahan harga tidak dipengaruhi oleh data waktu lalu, dan oleh karena itu seri perubahan harga masa lalu tidak bisa digunakan untuk menaksir perilaku harga waktu akan datang secara signifikan.

Sedangkan Richard R. West (1975) menjelaskan pengertian dari efisiensi pasar modal sebagai berikut:

1) External Efficiency

Pasar modal yang informasinya tersedia secara luas dan murah untuk para investor dan semua informasi yang relevan telah dicerminkan dalam harga-harga surat berharga tersebut.

2) Internal Efficiency

Pasar yang menyediakan jasa transaksi untuk pembelian dan penjualan dengan biaya serendah mungkin dan mampu mengakomodasikan kondisi kelebihan penawaran dan permintaan temporer.

3) Allocation Efficiency

Pasar dikatakan efisien apabila pasar modal dapat melaksanakan alokasi dana secara efisien. Francis menyebutkan bahwa *allocational efficiency* terjadi bila penetapan harga sedemikian rupa sehingga *rate of return* yang sudah disesuaikan dengan resiko marginal sama bagi penabung dan investor. *Allocational efficiency* disebut juga efisiensi makro.

2.2.2. Alasan Pasar Modal Efisien

Terdapat beberapa alasan yang menyebabkan pasar menjadi efisien. Pasar efisien dapat terjadi karena peristiwa-peristiwa berikut ini:

1. Investor adalah penerima harga (*price taker*), yang berarti bahwa sebagai pelaku pasar, investor seorang diri tidak dapat mempengaruhi harga dari suatu sekuritas. Harga sekuritas ditentukan oleh banyak investor yang menentukan *demand* dan *supply*.

2. Informasi tersedia secara luas kepada semua pelaku pasar pada saat yang bersamaan dan harga untuk memperoleh informasi tersebut murah. Umumnya pelaku pasar menerima informasi lewat radio, koran, atau media masa lainnya.
3. Informasi dihasilkan secara acak (random) dan tiap-tiap pengumuman informasi sifatnya random. Artinya bahwa investor tidak dapat memprediksi kapan emiten akan mengumumkan informasi baru.
4. Investor bereaksi dengan menggunakan informasi secara penuh dan cepat, sehingga harga dari sekuritas berubah dengan semestinya mencerminkan informasi tersebut untuk mencapai keseimbangan yang baru.

Haugen (2001) menerangkan bahwa ada empat ciri atau karakteristik pasar yang efisien, yaitu:

1. Harga sekuritas bertindak secara cepat (*quick*) dan tepat (*accurately*) bila menerima informasi baru yang relevan.
2. Perubahan hasil (*return*) saham yang diharapkan dari waktu ke waktu dihubungkan dengan tingkat bunga bebas resiko dan perubahan tingkat risiko premium atas sekuritas bersangkutan.
3. Kita tidak bisa membedakan antara investasi yang menguntungkan dengan investasi yang tidak menguntungkan untuk waktu yang akan datang berdasar ciri-ciri investasi saat ini atau waktu lalu

4. Jika kita memisahkan investor yang ahli dengan investor yang tidak ahli, maka kita tidak dapat membuat perbedaan secara nyata diantara prestasi kedua kelompok investor tersebut.

2.2.3. Bentuk-Bentuk Efisiensi Pasar

- **Efisiensi Pasar Secara Informasi**

Efisiensi pasar modal tergantung pada kondisi tertentu, terutama volume perdagangan. Pasar dengan volume perdagangan yang relative kecil menyulitkan investor untuk bereaksi terhadap informasi baru dan memudahkan bagi pedagang besar untuk memanipulasi karena adanya *channel* informasi (Banner, 1985).

Kunci utama untuk mengukur pasar yang efisien adalah hubungan antara harga sekuritas dengan informasi. Fama (1970) menyajikan tiga macam bentuk utama dari efisiensi pasar berdasarkan ketiga macam bentuk dari informasi, yaitu informasi masa lalu, informasi sekarang yang sedang dipublikasikan dan informasi privat sebagai berikut:

- 1) Efisiensi Pasar Bentuk Lemah (*weak form efficiency*)

Dalam efisiensi bentuk lemah ini menyatakan bahwa harga sekuritas saat ini mencerminkan informasi harga sekuritas dimasa lalu. Nilai tukar aktual berubah secara random sekitar tingkat keseimbangan yang diharapkan hal ini disebut *random walk hypothesis*. Random walk hypothesis memberikan alasan ekonomi yang baik untuk menerangkan pergerakan harga yang tidak beraturan. Harga sekuritas bereaksi secara cepat terhadap informasi yang ada, tetapi tidak dapat diperkirakan. Karena harga sekuritas bereaksi secara sensitif

terhadap kejadian yang tidak dapat diperkirakan yang secara acak mempengaruhi pasar, maka nilai tukar bergerak secara random. Berdasarkan penelitian-penelitian yang dilakukan, momentum suatu harga saham itu memang ada dan jika para investor dapat dengan cepat melakukan transaksi pada awal pergerakan naik harga saham-saham tersebut, maka keuntungan besar dapat dicapai oleh investor.

2) Efisiensi Pasar Bentuk Semi Kuat (*semi-strong form*)

Pada efisiensi bentuk setengah kuat ini nilai tukar yang akan datang tidak hanya menggambarkan nilai tukar di masa lalu tetapi juga dipengaruhi oleh informasi yang dipublikasikan. Hal ini berarti bahwa pelaku di pasar valas tidak akan mendapatkan kelebihan pendapatan. Informasi yang dipublikasikan berhubungan dengan pasar valuta asing diantaranya adalah data harga dan volume historis serta data-data atau informasi lainnya yang tersedia bagi publik seperti pendapatan perseroan, *dividen*, saham bonus, inflasi, serta *stock split*. Teori ini memberikan tekanan pada kecepatan informasi yang diterima oleh para pemodal pada waktu yang hampir bersamaan, sehingga harga secara langsung dan cepat melakukan penyesuaian.

3) Efisiensi Pasar Bentuk Kuat (*strong form efficiency*)

Efisiensi bentuk lemah menyatakan bahwa tidak ada satupun informasi yang tersedia bagi publik maupun privat yang memungkinkan para pemodal untuk meraih keuntungan yang tidak normal secara konsisten. Pada efisiensi bentuk kuat ini menyatakan bahwa harga saham akan melakukan penyesuaian secara cepat terhadap informasi apapun, bahkan informasi yang tidak tersedia bagi

semua pemodal (informasi privat). Salah satu jenis informasi privat adalah jenis informasi yang berasal dari orang dalam. Mereka mempunyai akses atas informasi berharga mengenai keputusan penting yang bersifat taktis dan strategis yang telah direncanakan oleh perusahaan. Data empiris menyatakan bahwa informasi privat mampu memberikan keuntungan abnormal yang konsisten bagi pemodal.

Gambar 2.2. Tingkatan kumulatif dari ketiga bentuk pasar efisien.

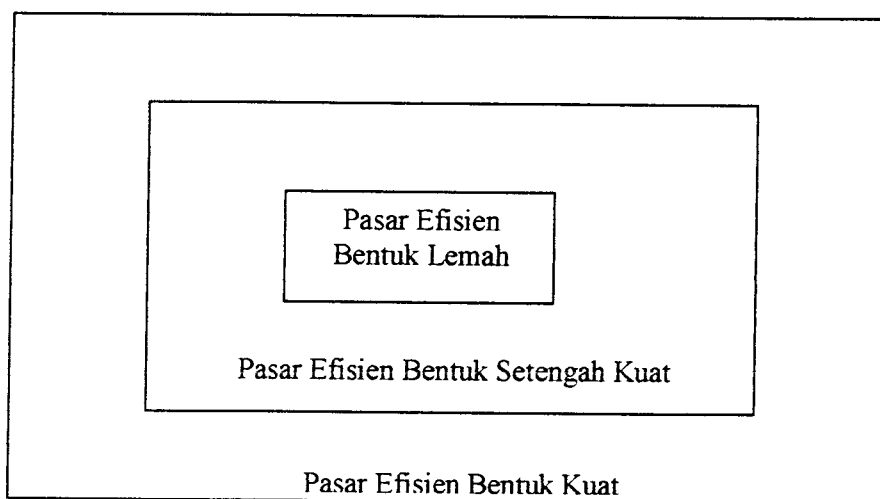

Ketiga bentuk pasar efisien ini berhubungan satu dengan yang lainnya. Hubungan ketiga bentuk pasar efisien ini berupa tingkatan kumulatif, yaitu bentuk lemah merupakan bagian dari bentuk setengah kuat dan bentuk setengah kuat merupakan bagian dari bentuk kuat.

- **Efisiensi Pasar secara Keputusan**

Pembagian efisiensi pasar menurut Fama didasarkan pada ketersediaan informasi. Informasi itu sendiri ada yang tidak perlu diolah lebih lanjut dan ada informasi yang masih perlu diolah lebih lanjut. Untuk informasi yang tidak perlu diolah lebih lanjut, seperti misalnya informasi tentang pengumuman laba perusahaan. Sedangkan informasi yang masih perlu diolah lebih lanjut misalnya, informasi tentang pengumuman merger oleh suatu perusahaan emiten. Dalam hal ini pelaku pasar harus menginterpretasikan dan menganalisis informasi merger tersebut sebagai kabar baik atau kabar buruk.

Dengan demikian pembagian efisiensi pasar berdasarkan ketersediaan informasi saja tidaklah cukup. Efisiensi pasar perlu juga dilihat berdasarkan kecanggihan pelaku pasar dalam mengolah informasi untuk mengambil keputusan. Menurut Fama, efisiensi pasar secara keputusan juga merupakan efisiensi pasar bentuk setengah kuat. Perbedaannya adalah jika efisiensi pasar secara informasi hanya mempertimbangkan ketersediaan informasi, maka efisiensi pasar secara keputusan mempertimbangkan dua buah faktor, yaitu ketersediaan informasi dan kecanggihan pelaku pasar.

Gambar 2.3. Tingkatan Kumulatif dari keempat bentuk Pasar Efisien.

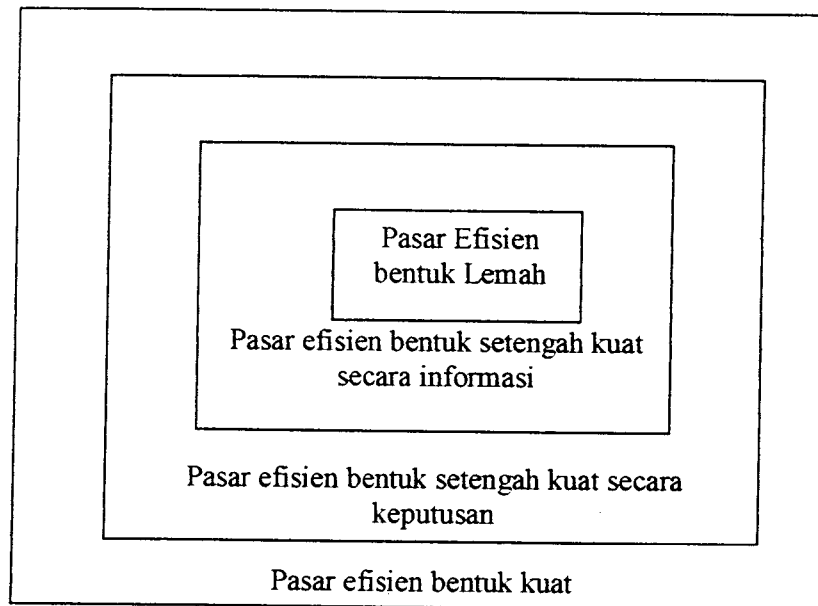

2.2.4 Pengujian Empiris Terhadap Efisiensi Pasar Modal

Di dalam artikelnya tahun 1991, Fama menyempurnakan atas klasifikasi ketiga macam bentuk efisiensi pasar menjadi:

1. Pengujian efisiensi pasar bentuk lemah disempurnakan menjadi pengujian terhadap prediktabilitas *return* (*test for return predictability*).
2. Pengujian efisiensi pasar bentuk setengah kuat disempurnakan menjadi pengujian peristiwa (*event study*).
3. Pengujian efisiensi pasar bentuk kuat disempurnakan menjadi pengujian terhadap informasi privat (*test for private information*).

- **Pengujian Prediktabilitas Return**

Pengujian dari efisiensi pasar bentuk lemah difokuskan pada prediksi return atau harga sekuritas berdasarkan return atau harga dimasa lalu. Jika Hipotesis Pasar Efisien benar, maka perubahan harga masa lalu tidak berhubungan dengan harga sekuritas sekarang, sehingga tidak dapat digunakan untuk memprediksi harga atau return dari sekuritas. Oleh karena itu, pengujian efisiensi pasar bentuk lemah melibatkan pertanyaan apakah informasi yang terkandung di harga-harga sekuritas masa lalu yang berurutan sudah secara penuh mencerminkan harga sekarang. Hipotesis untuk menguji bentuk lemah ini berhubungan dengan hipotesis langkah acak (*random walk hypothesis*). Jika harga-harga mengikuti pola langkah acak, maka perubahan harga dari waktu ke waktu sifatnya adalah random atau acak yang independen. Ada beberapa cara pengujian yang dapat dilakukan yaitu:

1. Pengujian Secara Statistik

Pengujian secara statistik dapat dilakukan dengan menguji independensi dari perubahan-perubahan harga sekuritas. Jika hasil pengujian menunjukkan independensi harga-harga, maka implikasinya adalah investor tidak dapat menggunakan nilai-nilai masa lalu. Pengujian statistik yang banyak dilakukan untuk pengujian independensi adalah pengujian hubungan variabel dengan menggunakan korelasi serial atau regresi linear dan pengujian run (*run test*).

2. Pengujian Menggunakan Korelasi dan Linier

Pengujian ini untuk menguji hubungan atau pengaruh antara return hari ini dengan return di waktu lalu. Semakin tinggi hubungan atau pengaruh antara return masa lalu dengan return saat ini, berarti semakin tinggi kemampuan return masa lalu tersebut akan memprediksi return masa depan.

$$r_t = a + b \cdot r_{t-1} + e_t$$

Dimana, r_t merupakan return hari ini, r_{t-1} adalah return sebelumnya, a menunjukkan tingkat return yang diharapkan yang tidak berhubungan atau tidak memiliki pengaruh dengan return sebelumnya, b menunjukkan besarnya hubungan atau pengaruh antara return di waktu yang lalu dengan return hari ini, sedangkan e adalah angka random yang merupakan variabilitas return yang tidak berhubungan dengan tingkat return sebelumnya. Kemudian setelah itu dapat dicari koefisien determinasinya (R^2) untuk melihat seberapa besar r_{t-1} mampu menjelaskan r_t .

3. Runs Test

Uji ini digunakan untuk menguji apakah perubahan harga saham bersifat acak (random) atau tidak. Pada analisis ini, perubahan harga ditandai dengan notasi (+) bila terjadi kenaikan harga, (-) bila terjadi penurunan harga, serta (0) bila tidak terdapat perubahan. Kumpulan tanda-tanda yang sama dari tiga tanda inilah yang disebut dengan runs. Bila perubahan harga sekuritas mempunyai korelasi (hubungan) atau pengaruh yang positif dari waktu ke waktu, maka diharapkan akan terjadi sedikit perubahan *runs*.

Sedangkan jika terdapat korelasi atau pengaruh yang negative, maka akan banyak perubahan *runs* yang terjadi.

- **Pengujian *Event Study***

Studi peristiwa (*event study*) merupakan studi yang mempelajari reaksi pasar terhadap suatu peristiwa yang informasinya dipublikasikan sebagai suatu pengumuman melalui harga sekuritasnya. *Event study* dapat digunakan untuk menguji kandungan informasi dari suatu pengumuman dan dapat juga digunakan untuk menguji efisiensi bentuk setengah kuat (Jogiyanto:2000).

Pengujian kandungan informasi dan pengujian efisiensi pasar bentuk setengah kuat merupakan pengujian yang berbeda. Pengujian informasi hanya dimaksudkan untuk melihat reaksi pasar terhadap suatu pengumuman, yang ditunjukkan dengan adanya perubahan harga dari sekuritas yang bersangkutan. Tetapi jika ingin melihat seberapa cepat pasar bereaksi untuk menyerap informasi yang dipublikasikan maka dilakukan pengujian efisiensi pasar secara informasi bentuk setengah kuat.

Event study menganalisis *abnormal return* dari sekuritas yang mungkin terjadi di sekitar tanggal penyusunan dari suatu peristiwa. *Abnormal return* merupakan kelebihan dari *return* yang sesungguhnya terjadi (*actual return*) terhadap *return* yang diharapkan oleh investor (*expectation return*). Oleh karena itu *abnormal return* adalah selisih antara *actual return* dengan *expectation return*, seperti rumus berikut:

$$AR_{i,t} = R_{i,t} - E[R_{i,t}]$$

Dimana:

$AR_{i,t}$ = Tingkat *Abnormal Return* sekuritas i pada waktu t

$R_{i,t}$ = *Actual Return* sekuritas i pada waktu t

$E[R_{i,t}]$ = *Expectation return* pada sekuritas i dalam periode t

- **Pengujian Terhadap Informasi Privat**

Pengujian dengan menggunakan informasi privat sulit dilaksanakan karena informasi privat yang akan diuji merupakan informasi yang tidak dapat diobservasi secara langsung. Oleh sebab itu, pengujian ini hanya dapat dilakukan secara tidak langsung dengan menggunakan proksi (wakil) yang berupa *return* yang diperoleh oleh *corporate insider* dan *return* dari reksa dana. Alasannya karena kedua pihak ini dianggap mempunyai informasi privat di dalam di dalam perdagangan sekuritas.

- a. Insider Trading. Insider trading merupakan perdagangan sekuritas yang dilakukan oleh corporate insider, dimana corporate insider tersebut meliputi direktur, manajer, karyawan atau pemegang saham yang dianggap bisa mendapatkan informasi privat yang tidak bisa diperoleh oleh pihak lainnya sebelum informasi tersebut dipublikasikan, sehingga mereka dapat menggunakan informasi privat tersebut untuk memperoleh abnormal return.
- b. Reksa Dana. Salah satu tujuan dari adanya reksa dana adalah meminimumkan risiko dengan cara membentuk portofolio (sekumpulan sekuritas) serta untuk

menghasilkan *return* yang tinggi. Tetapi jika reksa dana mampu menghasilkan *abnormal return* yang tinggi secara berlebihan berarti ada kemungkinan manajer reksa dana memperoleh informasi privat yang tidak dipublikasikan.

2.2.5 Konsepsi Yang Salah Mengenai Hipotesis Pasar Efisien

1. Pasar yang efisien menghendaki investornya untuk tidak melakukan apapun. Hal yang harus digaris bawahi adalah bahwa pada pasar yang efisien harga sekuritasnya sudah benar, dimana harga tersebut sudah menggambarkan seluruh informasi yang tersedia. Oleh karena itu dalam pasar yang efisien investor tidak perlu membuat pilihan terhadap sekuritas-sekuritas yang ada dalam membentuk portofolionya.
2. Fluktuasi harga dan pasar yang tidak efisien. Fluktuasi harga yang tinggi bukan berarti bahwa pasar tersebut tidak efisien, tetapi yang terpenting bahwa informasi yang ada didalamnya bersifat random.
3. Transaksi yang terbatas dan ketidakefisienan. Perdagangan yang lemah tidak selalu harus diartikan ketidakefisienan atau adanya ketidaktertarikan investor. Sedikitnya jumlah pedagang serta saham yang terjual tidak ada kaitannya dengan nilai saham yang sebenarnya. Selama para pedagang menggunakan informasi yang tersedia di public, jumlah pedagang yang sedikit tidak ada hubungannya dengan efisiensi pasar.

4. Zero dan Normal profit.

Pasar yang efisien tidak menghendaki para investornya untuk memperoleh zero profit, tetapi menghendaki para investor untuk memperoleh laba yang sesungguhnya, normal dan seimbang antara biaya dan sekuritas tersebut.

5. tidak adanya kesalahan harga pada sekuritas-sekuritas yang ada dalam pasar yang efisien. Hal ini bukan berarti bahwa para investor tidak pernah memperoleh abnormal return di dalam pasar yang efisien. Abnormal return bisa saja diperoleh karena sebuah keberuntungan tetapi tentunya hal ini tidak dapat bertahan lama.

2.3 Kajian Penelitian Terdahulu dan Formulasi Hipotesis

2.3.1 Kajian Penelitian Terdahulu

Ojah dan Karemera (1999)

Penelitian ini melakukan tes hipotesis pasar efisien bentuk lemah di bursa saham Amerika Latin (Argentina, Brazil, Chili, dan Mexico). Mereka menggunakan *multiple variance-ratio dan autoregressive fractionally integrated moving-average test* untuk menguji perilaku harga saham di pasar tersebut antara tahun 1987 hingga 1997. Hasil tes menunjukkan bahwa perubahan harga saham-saham di Amerika Latin mengikuti perubahan acak sehingga mendukung pasar efisien bentuk lemah.

Kleiman, Payne, dan Sahu (2002)

Penelitian ini menggunakan tes run untuk menguji pasar efisien bentuk lemah pada *international commercial real estate*. Tes run mendukung bahwa pasar real estate komersial internasional mengikuti hipotesis pasar efisien bentuk lemah. Hal ini konsisten dengan penemuan mereka mengenai perilaku perubahan acak dari saham-saham dengan menggunakan tes akar unit dan tes rasio varian.

Dockery, Vergari dan Vergari (2001)

Penelitian perubahan acak harga saham terhadap data bulanan selama tahun 1988 hingga 1994 terhadap saham individual pada Bursa Saham Athena (Athens Stock Exchange). Mereka menggunakan tes varian rasio untuk mengetahui adanya rata-rata ketergantungan antara perubahan harga saham. Hasil penelitian menunjukkan bahwa perilaku perubahan harga saham-saham di Bursa Saham Athena telah mengikuti perubahan acak. Hal ini mendukung hipotesis pasar efisien bentuk lemah.

Rao dan Shankaraiah (2003)

Penelitian ini melakukan pengujian terhadap efisiensi pasar bentuk lemah untuk saham-saham sector perbankan periode 1996 – 2000 studi kasus terhadap *Bahrain Stock Market*, data yang digunakan adalah perubahan harga saham harian dan persentase perubahan *return* pasar yang diperoleh dari harga saham individual harian dan indeks harian BSE. Uji yang digunakan adalah

serial correlation test dan run tes dengan hasil *Bahrain Stock Market* sudah efisien dalam bentuk lemah.

2.3.2 Formulasi Hipotesis

Berdasarkan teori yang telah dikemukakan serta sesuai dengan tinjauan penelitian-penelitian terdahulu, maka hipotesis yang dapat digunakan dalam penelitian ini adalah sebagai berikut:

1. Perubahan harga saham diwaktu lalu tidak ada pengaruhnya terhadap perubahan harga saham diwaktu sekarang.
2. Perubahan harga saham di BEJ bersifat tidak beraturan (*random*).

BAB III METODE PENELITIAN

3.1. Gambaran Umum Pasar Modal dan Bursa Efek Secara Umum

Secara formal pasar modal dapat didefinisikan sebagai pasar untuk berbagai instrumen keuangan (atau sekuritas) jangka panjang yang biasa diperjual belikan, baik dalam bentuk hutang ataupun modal sendiri, baik yang diterbitkan pemerintah, *public authorities*, maupun perusahaan swasta (Husnan : 2001). Sedangkan menurut Undang-Undang Pasar Modal No. 8 Tahun 1995, mendefinisikan pasar modal sebagai kegiatan yang bersangkutan dengan penawaran umum dan perdagangan efek, perusahaan publik yang berkaitan dengan efek yang diterbitkannya, serta lembaga dan profesi yang berkaitan dengan efek. Kata efek berasal dari bahasa Belanda *effecten*. Menurut kamus bahasa latin yang disusun oleh Drs.Prent.C.M dan Drs.J.Adisubrata kata ini digolongkan sebagai kata benda, *effectus* berarti pelaksanaan, pengalaman, hal mempraktikan, pekerjaan dan penyesuaian, jika dianggap sebagai kata sifat artinya sempurna.

Definisi tentang efek digunakan secara resmi pada tahun 1947 dalam *Beschikking Beursverkeer* dd 27 Maart 1947 art 1. Menurut definisi efek adalah saham, obligasi, surat gadai, bukti keuntungan dan surat berharga serupa. Bursa merupakan suatu tempat untuk memperdagangkan sekuritas. Sekuritas-sekuritas yang diperdagangkan di Bursa Efek Jakarta (BEJ) terdiri dari saham biasa, saham preferen, obligasi, obligasi konversi, sertifikat right dan waran. Menurut Undang-

Undang Pasar Modal No. 8 Tahun 1995, bursa efek adalah pihak yang menyelenggarakan dan menyediakan sistem dan atau sarana untuk mempertemukan penawar jual dan beli efek dengan tujuan memperdagangkan Efek diantara mereka. Adapun fungsi dari Bursa Efek ini adalah untuk menjaga kontinuitas atau kelangsungan pasar, serta menciptakan harga Efek yang wajar melalui mekanisme permintaan dan penawaran.

3.2 Populasi dan Sampel

Penelitian ini mengambil populasi seluruh perusahaan teknologi yang terdaftar di Bursa Efek Jakarta (BEJ). Pengambilan sampel dilakukan dengan metode *purposive sampling*, yaitu teknik sampling yang dalam pengambilan sampelnya didasarkan atas kriteria tertentu. Sampel dalam penelitian ini adalah perusahaan teknologi yang listed di BEJ sebelum tanggal 31 Desember 2000 dan konsisten sampai dengan tanggal 31 Desember 2003, dengan kriteria:

1. Selama periode penelitian, saham perusahaan sampel harus tetap aktif diperdagangkan setiap harinya, sehingga setiap perusahaan sampel tersebut akan memiliki *return* saham harian
2. Peristiwa politik dan ekonomi lain yang terjadi diabaikan.

3.3 Variabel Penelitian

Penelitian ini diuji secara statistik dengan menggunakan beberapa variabel.

Variabel-variabel tersebut adalah:

- Pt : Harga saham pada waktu ke-t, merupakan harga penutupan saham biasa perusahaan sektor teknologi yang terpilih menjadi sampel pada periode t selama periode pengamatan.
- Pt-1 : Harga saham pada waktu sebelum t, juga merupakan harga penutupan saham biasa perusahaan sektor teknologi yang terpilih menjadi sampel pada periode sebelum t selama periode pengamatan.

3.4 Teknik Pengumpulan Data

a. Studi Pustaka

Dengan mempelajari dan mengumpulkan literatur-literatur serta penelitian-penelitian terdahulu yang terkait dengan masalah yang akan dibahas dalam penelitian ini sebagai landasan teori untuk memecahkan masalah yang ada.

b. Observasi

Adalah metode pengumpulan data dengan cara melakukan pengamatan langsung terhadap obyek yang diteliti. Data diambil dari pojok BEJ yang terdapat di Fakultas Ekonomi Universitas Islam Indonesia.

3.5 Prosedur Penelitian

Langkah-langkah yang dilakukan dalam penelitian ini adalah:

1. Tes Statistik

Untuk memprediksi ada tidaknya pengaruh variabel x (return saham periode sebelumnya) terhadap variabel y (return saham periode sekarang), maka dilakukan pengujian regresi model linear sederhana dan setelah itu dilanjutkan dengan uji Q-statistik.

Sedangkan untuk melihat apakah perubahan harga saham perusahaan sampel bersifat acak (*random*) atau tidak, maka dilakukan uji statistik non parametrik dengan melakukan tes runtun (*runs test*). Uji statistik non parametrik adalah uji statistik yang modelnya tidak menetapkan syarat-syarat mengenai parameter-parameter populasi, selain itu observasi-observasinya independen dan variabel yang diteliti pada dasarnya memiliki kontinuitas (Wahid Sulaiman:2003).

2. Analisa dan Interpretasi

Setelah dilakukan pengujian statistik, langkah selanjutnya adalah menganalisis hasil temuan kuantitatif dan menginterpretasikannya sehingga dapat dimengerti dan dapat ditarik kesimpulan.

3. Pengambilan Kesimpulan

Kesimpulan diperoleh berdasarkan hasil dari analisis dan interpretasi atas nilai-nilai statistik yang diperoleh, kemudian dapat diketahui apakah hipotesis nol ditolak ataukah diterima.

3.6 Langkah-langkah Analisis

Untuk mendapatkan suatu kesimpulan, penelitian ini melalui beberapa proses pada awal penelitian dan pada saat dilakukannya analisis, yang meliputi:

1. Melakukan identifikasi terhadap perusahaan sektor teknologi mana saja yang layak untuk dijadikan sampel.
2. Melakukan cek kelengkapan data yang dibutuhkan di Pojok BEJ FE-UII. Adapun data yang dibutuhkan adalah harga penutupan setiap harinya dari perusahaan-perusahaan sektor teknologi yang masuk ke dalam sampel.
3. Melakukan pengujian statistik yang diperlukan seperti yang telah tertulis pada prosedur penelitian.
4. Melakukan pengujian terhadap hipotesis yang telah dirumuskan.
5. Melakukan analisis dan interpretasi terhadap hasil uji statistik dan hipotesis.
6. Mengambil kesimpulan dari pembuktian hipotesis dan memberikan rekomendasi untuk penelitian selanjutnya.

3.7 Pengujian Hipotesis

3.7.1 Uji Regresi Linear

Uji regresi linear ini digunakan untuk menguji ada tidaknya pengaruh perubahan harga saham pada waktu lalu dengan perubahan harga saham saat ini.

Analisis hipotesis nol dan alternatif yang terbentuk adalah:

H_{01} : Perubahan harga saham waktu lalu tidak ada pengaruhnya terhadap perubahan harga saham di waktu sekarang.

H_{a1} : Perubahan harga saham diwaktu lalu memiliki pengaruh terhadap perubahan harga saham diwaktu sekarang.

Penelitian ini menggunakan level signifikansi 95% atau $\alpha = 5\%$ yang pada umumnya digunakan dalam penelitian ekonomi. Setelah diperoleh Q-statistiknya, maka dicari nilai peluangnya (*prob-value*) dalam tabel. Kriteria validitasnya adalah:

Jika, prob-value nilai $Q < 5\%$, tolak H_{01}

Jika, prob-value nilai $Q > 5\%$, tidak tolak H_{01}

Dengan langkah-langkah pengujian hipotesis seperti diatas, dapat diinterpretasikan dan ditarik kesimpulan apakah perubahan harga saham di waktu lalu ada pengaruhnya dengan perubahan harga saham di waktu sekarang atau tidak. Adapun program komputer yang digunakan untuk melakukan uji statistic ini adalah E-Views.

3.7.2 Tes Runtun (*Runs Test*)

Pengertian runtun disini adalah urutan perubahan harga untuk satu tanda, dimana tanda-anda itu dapat berupa (+) jika perubahan harga naik, (-) jika perubahan harga turun, dan nol (0) jika perubahan harga tetap. Notasi atau tanda perubahan tersebut yang nantinya akan menjadi variabel dalam tes ini. Tes runrun digunakan untuk menguji apakah perubahan harga saham di perusahaan sampel

bersifat *random* atau tidak. Dalam menguji tes runtun ini menggunakan program komputer statistik SPSS.

Hipotesis nol dan alternatif yang terbentuk adalah:

H₀ : Perubahan harga saham yang terjadi di Bursa Efek Jakarta (BEJ) bersifat tidak beraturan (random).

H_a : Perubahan harga saham yang terjadi di Bursa Efek Jakarta (BEJ) bersifat beraturan.

Hipotesis ini akan diuji dengan menggunakan uji non-parametrik, yaitu uji statistik yang tidak berdasarkan pada besaran-besaran populasi, berupa tes runtun (runs test) dengan uji Z, dengan langkah-langkah sebagai berikut:

1. membandingkan harga penutupan saham sekarang perusahaan-perusahaan sampel dengan harga saham sebelumnya.
2. Menentukan posisi perubahan, jika naik diberi tanda positif (+), turun diberi tanda negatif (-), dan tetap diberi tanda nol (0).
3. Menghitung jumlah masing-masing tanda untuk setiap periode yang diobservasi.
4. Menghitung runtun harapan untuk seluruh tanda dengan rumus yang digunakan oleh Fama (1965) dikutip dari Legowo dan Machfoedz (1998):

$$m = \frac{\left[N(N + 1) - \sum_{i=1}^3 m_i^2 \right]}{N}$$

Keterangan:

m : runtun harapan

N : jumlah perubahan harga

ni : jumlah perubahan harga setiap tanda

5. Menghitung deviasi standar dengan rumus yang digunakan oleh fama (1965) dikutip dari Legowo dan Machfoedz (1998):

$$\sigma_m: \left[\frac{\left[\sum_{i=1}^3 ni^2 \left\{ \sum_{i=1}^3 ni^{2+N(N+1)} - 2N \sum_{i=1}^3 ni^{3-N^3} \right\} \right]}{N^2(n-1)} \right]^{1/2}$$

6. Menghitung Z, karena perubahan harga mengikuti atau menyesuaikan dengan distribusi normal (karakteristik dari random walk theory). Adapun rumus yang digunakan adalah (Legowo dan Machfoedz : 1998):

$$Z = \frac{(R \pm \frac{1}{2}) - m}{\sigma_m}$$

Keterangan:

$\pm \frac{1}{2}$ adalah koreksi kontinum

+ $\frac{1}{2}$ Jika $R < m$

- $\frac{1}{2}$ Jika $R > m$

7. Mencari *Prob-Value*

Berdasar Z hitung, selanjutnya dicari nilai probabilitas (prob-value) dalam tabel.

8. Menentukan besarnya alpha (α) yaitu 5% dan mengevaluasi hasil pengolahan data berdasarkan *prob-value*.

9. Melakukan uji keacakan (*randomness test*)

Uji ini dilakukan untuk setiap harga saham perusahaan yang dipilih.

Pengujiannya adalah dengan membandingkan nilai peluang dua sisi dengan α .

Sehingga, jika *prob-value* nilai $Z < 5\%$, tolak H_0

jika *prob-value* nilai $Z < 5\%$, tidak tolak H_0

BAB IV

ANALISIS DAN PEMBAHASAN

Dalam bab ini akan dijelaskan mengenai proses pengumpulan data awal, perhitungan variabel yang diperlukan, pengolahan data, analisis dan interpretasi hasil pengujian hipotesis yang terdiri dari deskripsi penelitian, serta pengungkapan hasil penelitian dan pembahasannya.

4.1 Deskripsi Penelitian

4.1.1 Persiapan Awal Penelitian

Data yang diperlukan dalam penelitian ini adalah *return* saham biasa harian yang diperoleh dari harga penutupan saham hari ini dikurangi dengan harga penutupan saham hari sebelumnya dan dibagi dengan harga saham biasa hari sebelumnya. Data *return* tersebut akan menjadi variabel data dalam penelitian ini.

4.1.2 Proses Penelitian

Populasi yang digunakan dalam penelitian ini adalah perusahaan sektor teknologi yang listed di BEJ hingga tahun 2003. Data tentang return saham harian diperoleh dari Pojok BEJ yang terdapat di Fakultas Ekonomi Universitas Islam Indonesia. Hipotesis dibuktikan melalui pengujian statistic dengan menggunakan Microsoft Excel untuk perhitungan awal variabel penelitian berupa return saham dan selanjutnya menggunakan E-Views dan SPSS untuk pengolahan data secara statistik.

4.2 Analisis Data

4.2.1 Pengukuran Return

Return saham menunjukkan selisih antara harga saham pada periode t dengan harga saham pada periode t-1 dibagi harga saham t-1. secara sistematis dapat dirumuskan sebagai berikut:

$$R_{it} = \frac{P_{it} - P_{it-1}}{P_{it-1}}$$

Dimana:

R_{it} : *Return* Saham

P_{it} : Harga Saham pada periode t

P_{it-1} : Harga Saham pada periode t-1

Sebagai contoh perhitungan return saham pada PT. Telekomunikasi Indonesia Tbk. (TLKM) pada t-11 tahun 2000 dengan harga saham penutupan sebesar Rp. 4100 dan t-10 pada tahun 2000 dengan harga penutupan sebesar Rp. 4000, maka besarnya return saham pada t-11 tahun 2000 adalah:

$$R_{it} = \frac{4100 - 4000}{4000} = 0,025$$

Return saham sebesar 0,025 menunjukkan bahwa investor memperoleh keuntungan saham sebesar 2,5 % dari harga saham sebelumnya. Untuk perhitungan return saham pada hari dan emiten yang lain dapat dilakukan dengan perhitungan yang sama seperti pada lampiran.

Gambar 4.1 Perubahan Harga saham

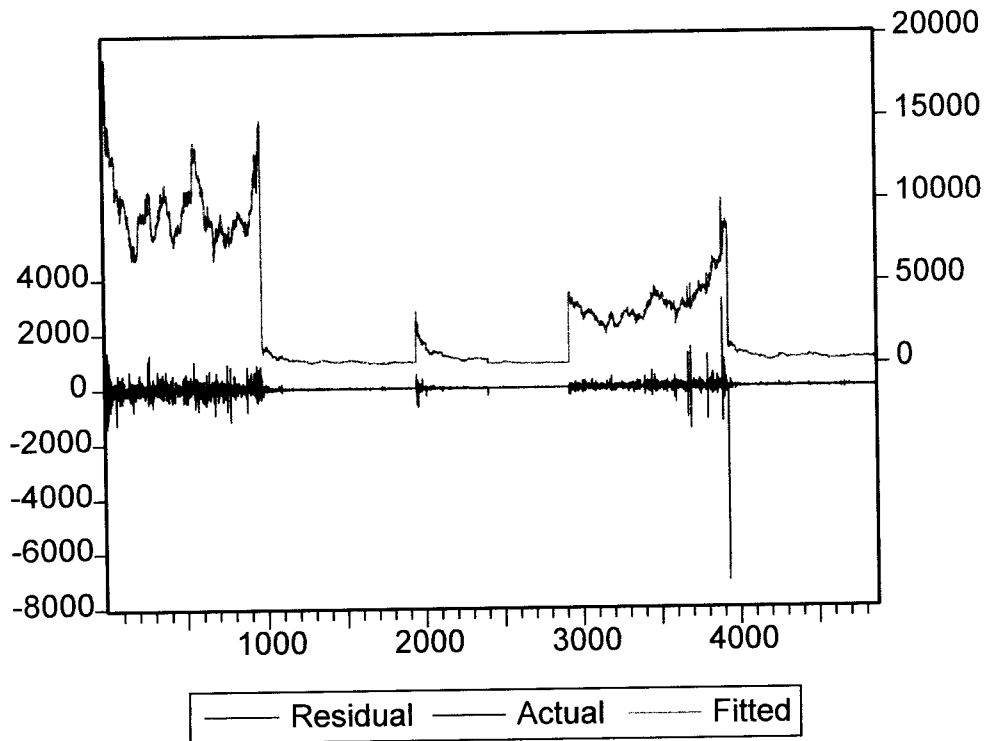

Dari gambar diatas dapat dilihat bahwa nilai residual (nilai sisa) yang ditandai dengan garis berwarna biru, selalu mendekati nol ini berarti bahwa harga yang tercermin cenderung stabil. Sedangkan garis antara nilai aktual (nilai nyata) yang berwarna merah dan garis Fitted (nilai semu) yang berwarna hijau hampir tidak jelas terlihat perbedaannya ini menjelaskan bahwa harga saham yang ada selalu seimbang antara kenyataan dengan fitted-nya.

4.2.2 Analisis Deskriptif

Setelah melakukan perhitungan *return* pada seluruh data penelitian di masing-masing perusahaan sampel, selanjutnya dapat dilakukan pengujian hipotesis dengan menggunakan analisis regresi linear dan tes runtun (*runs test*). Jenis penelitian ini menggunakan data Time Series dimana perlu data runtun waktu dengan jarak waktu yang sama, data tersebut dapat dilihat pada LAMPIRAN 4. Analisis regresi linear merupakan analisis yang digunakan untuk mengetahui ada tidaknya pengaruh perubahan harga saham saat ini dengan perubahan harga saham pada waktu lalu. Jika perubahan harga saham pada saat ini tidak memiliki pengaruh dengan perubahan harga saham di waktu yang lalu maka pasar dalam keadaan efisien dalam bentuk lemah. Pada tes runtun (*runs test*) digunakan untuk mengetahui apakah perubahan harga saham yang terjadi di Bursa Efek Jakarta (BEJ) khususnya pada perusahaan sampel bersifat random. Jika perubahan harga saham bersifat random, maka pasar dapat dikatakan pasar efisien dalam bentuk lemah.

4.3 Pengujian Hipotesis

4.3.1 Pengujian Hipotesis Pertama

Dalam penelitian ini analisis regresi linear menggunakan pendekatan *prob-value* dengan tingkat signifikansi 5% pada masing-masing perusahaan sampel selama periode penelitian. Uji ini digunakan untuk mengetahui ada tidaknya pengaruh perubahan harga saham pada waktu lalu dengan perubahan harga saham pada saat ini. Langkah-langkah yang dilakukan adalah sebagai berikut:

- **Menentukan hipotesis dan alternatif hipotesis**

Ho : $\mu_1 = \mu_2$ Perubahan harga saham waktu lalu tidak ada pengaruhnya terhadap perubahan harga saham di waktu sekarang.

Ha : $\mu_1 \neq \mu_2$ Perubahan harga saham di waktu lalu memiliki pengaruh terhadap perubahan harga saham di waktu sekarang.

- **Membuat Kriteria Pengujian Hipotesis**

Apabila prob-value nilai Q lebih kecil dari α ($\alpha = 5\%$), maka hasilnya signifikan atau tolak Ho, dan apabila prob-value nilai Q lebih besar dari α ($\alpha = 5\%$), maka hasilnya tidak signifikan atau tidak signifikan atau tidak ditolak Ho. *Prob-value* nilai Q hasil uji regresi untuk setiap lag, yaitu mulai dari lag 1 hingga lag 5 untuk masing-masing perusahaan sampel yang dilakukan dalam penelitian ini dapat dilihat pada TABEL 4.1 berikut:

TABEL 4.1

Hasil Uji Regresi *Prob-Value* Q Perubahan Harga Saham
 Pada Masing-Masing Perusahaan Sampel
 Untuk Lag 1 Hingga Lag 12 Periode 2000 – 2003

Kode Saham Perusahaan	Lag 1	Lag 2	Lag 3	Lag 4	Lag 5
ASGR	0.732	0.578	0.705	0.472	0.329
ISAT	0.843	0.980	0.368	0.503	0.603
MLPL	0.685	0.016	0.016	0.028	0.037
MTDL	0.436	0.274	0.199	0.325	0.458
TLKM	0.518	0.002	0.006	0.008	0.016

Dari tabel 4.1 diatas dapat dilihat bahwa untuk perusahaan Astra Graphia Tbk diperoleh *prob-value* Q yang tidak signifikan baik dari lag 1 hingga lag 5, karena nilai signifikansi untuk masing-masing lag seluruhnya lebih besar dari 5%. Dengan hasil yang menunjukkan bahwa tidak ada nilai yang signifikan, ini membuktikan tidak dapat ditolakny hipotesis nol, sehingga untuk perusahaan Astra Graphia Tbk perubahan harga saham-sahamnya pada waktu lalu tidak memberikan pengaruh kepada perubahan harga saham di waktu sekarang.

Sama halnya dengan yang terjadi pada perusahaan sebelumnya, pada perusahaan PT Indosat Tbk seluruh hasil dari *prob-value* untuk $\alpha=5\%$ diperoleh hasil

yang tidak signifikan karena seluruh angkanya menunjukkan hasil yang lebih besar dari 5%, sehingga dalam hal ini H_0 tidak dapat ditolak. Dari hasil ini dapat menjelaskan bahwa pada perusahaan PT Indosat Tbk, perubahan harga saham perusahaan diwaktu lalu tidak mempengaruhi perubahan harga saham diwaktu sekarang.

Pada perusahaan Multipolar Tbk, diperoleh hasil *prob-value* Q yang seluruhnya menyatakan tidak dapat menolak H_0 , karena nilai probabilitas yang ada seluruhnya tidak ada yang lebih kecil dari 5%. Dari hasil ini tentunya dapat menjelaskan bahwa perubahan harga saham pada waktu lalu tidak mempengaruhi perubahan harga saham diwaktu sekarang di perusahaan Multipolar Tbk.

Berdasarkan hasil uji regresi untuk perusahaan Metrodata Elektronik Tbk, diperoleh *prob-value* Q yang tidak signifikan baik pada lag pertama hingga lag kelima, karena nilai signifikansi untuk masing-masing lag seluruhnya menunjukkan angka yang lebih besar dari 5%. Ini menjelaskan bahwa tidak dapat ditolaknya hipotesis nol, serta menunjukkan bahwa pada perusahaan Metrodata Elektronik Tbk, perubahan harga saham perusahaan diwaktu lalu tidak mempengaruhi perubahan harga saham perusahaan diwaktu sekarang.

Pada perusahaan PT Telekomunikasi Indonesia Tbk, jika dilihat pada nilai *prob-value* pada lag kedua menunjukkan hasil yang signifikan, tetapi lag pertama, ketiga hingga lag kelima menunjukkan hasil yang tidak signifikan. Secara keseluruhan dilihat dari hasil regresi ini, sebagian besar menunjukkan nilai yang tidak signifikan sehingga H_0 tidak dapat ditolak atau dapat dikatakan bahwa perubahan

harga saham diwaktu lalu pada perusahaan PT Telekomunikasi Indonesia Tbk tidak mempengaruhi perubahan harga saham diwaktu sekarang.

4.2.2 Pengujian Hipotesis Kedua

Untuk melakukan pengujian hipotesis kedua dilakukan dengan pengujian tes runtun (*runs test*). Uji ini digunakan untuk menguji apakah perubahan harga saham di perusahaan sampel bersifat random atau tidak.

- **Menentukan hipotesis dan alternatif hipotesis**

Ho : $\mu_1 = \mu_2$ Perubahan harga saham yang terjadi di Bursa Efek Jakarta (BEJ) bersifat tidak beraturan (random).

Ha : $\mu_1 \neq \mu_2$ Perubahan harga saham yang terjadi di Bursa Efek Jakarta (BEJ) bersifat beraturan.

- **Membuat kriteria pengujian hipotesis**

Jika prob-value nilai Z lebih kecil dari $\alpha = 5\%$ maka hasilnya signifikan atau Ho akan ditolak, tetapi jika prob-value nilai Z lebih besar dari $\alpha = 5\%$ maka hasilnya tidak signifikan atau Ho tidak dapat ditolak. Hasil *runs test* untuk masing-masing perusahaan sampel selama periode penelitian dapat dilihat pada tabel 4.2 berikut:

TABEL 4.2

Hasil Runs Test *Prob-Value Z* Perubahan Harga Saham
Periode 2000 – 2003

No	Perusahaan	Prob-Value Nilai Z	Ho
1	TLKM	0.869	Tidak Ditolak
2	MTDL	0.192	Tidak Ditolak
3	ASGR	0.132	Tidak Ditolak
4	ISAT	0.457	Tidak Ditolak
5	MLPL	0.445	Tidak Ditolak
6	Keseluruhan	0.114	Tidak Ditolak

Berdasarkan tabel diatas dapat terlihat secara jelas bahwa nilai probabilitas Z untuk seluruh perusahaan sampel baik individu maupun secara keseluruhan menunjukkan hasil yang tidak signifikan, karena nilai signifikansi yang dihasilkan melalui uji dua sisi, seluruhnya menunjukkan angka lebih besar dari 5%. Jika *prob-value* semakin tinggi maka perubahan harga saham akan cenderung stabil, dan sebaliknya jika *prob-value* yang dihasilkan rendah menggambarkan perubahan harga saham yang fluktuatif. Dari hasil *runs test* ini maka dapat membuktikan bahwa Ho tidak dapat ditolak karena nilai probabilitas yang ada seluruhnya diatas 5%. Atau dengan kata lain perubahan harga saham di Bursa Efek Jakarta (BEJ) untuk perusahaan sektor teknologi Periode 2000 – 2003 sudah bersifat acak (*random*).

Setelah dilakukan pengujian yaitu uji regresi linear dan uji *runs test*, dengan hasil yang berturut-turut menjelaskan bahwa antara perubahan harga saham untuk sektor teknologi khususnya perusahaan sampel pada waktu lalu tidak ada pengaruhnya dengan perubahan harga saham saat ini, serta menjelaskan bahwa perubahan harga saham di BEJ sudah bersifat acak (*random*), telah dapat membuktikan bahwa pasar modal Indonesia sudah dapat dikatakan efisien dalam bentuk lemah.

BAB V

PENUTUP

Pada bab ini akan dikemukakan kesimpulan dari hasil penelitian yang telah dilakukan, keterbatasan dalam penelitian ini yang dapat digunakan sebagai rekomendasi untuk penelitian berikutnya yang sejenis, dan implikasi dari penelitian ini dalam kehidupan nyata.

5.1 Kesimpulan

1. Berdasarkan hasil uji regresi linear, dapat dijelaskan bahwa secara individual perusahaan-perusahaan pada sektor teknologi memiliki *prob-value* Q yang tidak signifikan, karena seluruh nilai probabilitasnya menunjukkan hasil yang lebih besar dari 5%. Ini berarti hipotesis nol tidak dapat ditolak, atau dengan kata lain menggambarkan bahwa tidak ada pengaruhnya antara perubahan harga saham diwaktu lalu pada perusahaan sektor teknologi periode 2000 – 2003 di BEJ dengan perubahan harga saham diwaktu sekarang.
2. Dari hasil uji runtun (*runs test*) dapat menjelaskan bahwa seluruh perusahaan sampel baik secara individu maupun keseluruhan pada periode penelitian menjelaskan bahwa seluruh *prob-value* Z menunjukkan nilai yang lebih besar dari α (5%), sehingga menjadikan H_0 tidak dapat ditolak atau dapat dikatakan bahwa perubahan harga saham di BEJ pada perusahaan-perusahaan sector teknologi untuk periode 2000 -2003 sudah bersifat acak (*random*).

3. Berdasarkan hasil uji regresi linear yang menggambarkan bahwa tidak ada pengaruh antara perubahan harga dimasa lalu dengan perubahan harga dimasa sekarang, serta hasil dari uji runtun (runs test) yang menunjukkan bahwa perubahan harga di BEJ sudah bersifat acak (random), maka dapat disimpulkan bahwa pasar modal Indonesia sudah efisien dalam bentuk lemah.

5.2 Keterbatasan Penelitian dan Rekomendasi Penelitian Berikutnya

Dalam penelitian ini terdapat beberapa keterbatasan dalam mengambil, memproses data, dan menginterpretasikan data. Keterbatasan pada penelitian ini diharapkan dapat menjadi rekomendasi untuk mengadakan penelitian berikutnya:

- Sampel yang digunakan dalam penelitian ini hanya terfokus pada perusahaan-perusahaan sektor teknologi saja sehingga untuk penelitian selanjutnya disarankan agar memperluas sampel penelitian sehingga dapat lebih menjelaskan tingkat efisiensi pasar modal Indonesia.
- Penelitian ini merupakan replikasi dari penelitian-penelitian sebelumnya, sehingga model pengujiannya terbatas pada uji regresi dan uji runtun (runs test), maka untuk penelitian-penelitian masa yang akan datang agar menggunakan model pengujian bentuk lain yang lebih canggih.
- Dalam penelitian ini penulis memiliki keterbatasan dalam menginterpretasikan hasil pengolahan data yang diperoleh, dan diharapkan untuk penelitian-penelitian selanjutnya dapat lebih menyempurnakan analisis penelitian.

DAFTAR PUSTAKA

- Abdul Halim, *Analisis investasi*, Edisi Pertama, Salemba Empat, Jakarta, 2003.
- Anthony, Robert N and Vijay Govindarajan, *Management Control System*, Irwin: Homewood, Illinois, 1995.
- Brenskin, A Leopold, *Financial Statement Analysis, Teori, Aplication and enterpretation*, 5th Edition, The McGraw – Hill Companies, 1993.
- D. Agus Harjito, *Pengujian Efisiensi Pasar Bentuk Lemah Di Bursa Saham Kuala Lumpur*, Jurnal Siasat Bisnis, Vol 1, 2003, Hal 33-51.
- Indonesia Capital Market Directory, 2000-2003.
- Jogiyanto H.M., *Teori Portofolio dan Analisis Investasi*, Edisi 2, BPFE Yogyakarta, 2001.
- Koetin, E.A., *Pasar Modal Indonesia*, Pustaka Sinar Harapan, 1996.
- Lisa Lubrina, *Analisis Efisiensi Pasar Bentuk Lemah pada Saham-Saham Perusahaan Sektor Manufaktur Studi Kasus Pada Bursa Efek Jakarta (BEJ)*, Skripsi Sarjana, Fakultas Ekonomi, Universitas Islam Indonesia, Yogyakarta, 2004.
- Nursiam & Lastiyono Doso Puteranto, *Analisis Efisiensi Pasar Modal Indonesia Periode 1998-2000*, Jurnal Akuntansi dan Keuangan, Vol 3, No 1, April 2004, Hal 1-23.
- Sri Opti, *Pengujian Efisiensi Pasar Nilai Tukar Rupiah Bentuk Lemah Periode 14 Agustus 1997 – Juni 1998*, Jurnal Ekonomi Keuangan dan Perbankan Vol VII, No 1, April 2002, Hal 19-27.
- Suad Husnan, *Dasar-Dasar Teori Portofolio dan Analisis Sekuritas*, Edisi 3, UPP AMP YKPN, Yogyakarta, 2001.
- Tjiptono Darmaji, Hendy M Fakhrudin, *Pasar Modal di Indonesia Pendekatan Tanya Jawab*, Edisi 1, Salemba Empat, Jakarta, 2001.
- Undang-Undang Republik Indonesia No.8 Tahun 1995 Tentang Pasar Modal.**

LAMPIRAN 1

DATA PERUSAHAAN

No	Kode Perusahaan	Nama Perusahaan
1	ASGR	Astra Graphia
2	ISAT	Indosat
3	MLPL	Multipolar
4	MTDL	Metrodata Elektronik
5	TLKM	Telekomunikasi Indonesia

LAMPIRAN 2

HASIL UJI REGRESI LINEAR

ASGR

Date: 12/25/04

Time: 11:43

Sample: 1 973

Included

observations: 973

Autocorrelation	Partial Correlation	AC	PAC	Q-Stat	Prob	
.		1	-0.011	-0.011	0.1170	0.732
.		2	-0.032	-0.032	1.0980	0.578
.		3	0.018	0.017	1.4032	0.705
.		4	-0.047	-0.047	3.5399	0.472
.		5	0.048	0.048	5.7719	0.329

ISAT

Date: 12/25/04 Time: 11:32

Sample: 1 973

Included observations: 973

Autocorrelation	Partial Correlation	AC	PAC	Q-Stat	Prob	
.		1	0.006	0.006	0.0394	0.843
.		2	0.001	0.001	0.0410	0.980
.		3	0.056	0.056	3.1597	0.368
.		4	0.013	0.013	3.3361	0.503
.		5	0.017	0.017	3.6343	0.603

MLPL

Date: 12/25/04 Time: 11:34

Sample: 1 973

Included observations: 973

Autocorrelation	Partial Correlation	AC	PAC	Q-Stat	Prob	
.		1	-0.013	-0.013	0.1645	0.685
*		2	-0.091	-0.091	8.2878	0.016
.		3	-0.046	-0.049	10.333	0.016
.		4	-0.024	-0.034	10.892	0.028
.		5	0.031	0.021	11.812	0.037

MTDL

Date: 12/25/04 Time: 11:35

Sample: 1 973

Included observations: 973

Autocorrelation		Partial Correlation		AC	PAC	Q-Stat	Prob
.		.		1 -0.025	-0.025	0.6073	0.436
.		.		2 -0.045	-0.046	2.5914	0.274
.		.		3 0.046	0.044	4.6528	0.199
.		.		4 0.002	0.002	4.6553	0.325
.		.		5 0.003	0.007	4.6650	0.458

TLKM

Date: 12/25/04 Time: 11:35

Sample: 1 973

Included observations: 973

Autocorrelation		Partial Correlation		AC	PAC	Q-Stat	Prob
.		.		1 -0.021	-0.021	0.4175	0.518
*		*		2 -0.110	-0.111	12.259	0.002
.		.		3 -0.019	-0.024	12.611	0.006
.		.		4 -0.036	-0.050	13.912	0.008
.		.		5 0.003	-0.004	13.924	0.016

LAMPIRAN 3

HASIL RUN TEST

TLKM

Runs Test

	Return
Test Value ^a	,000000000
Cases < Test Value	409
Cases >= Test Value	565
Total Cases	974
Number of Runs	473
Z	-,165
Asymp. Sig. (2-tailed)	,869

a. Median

MTDL

Runs Test

	Return
Test Value ^a	,000000000
Cases < Test Value	348
Cases >= Test Value	626
Total Cases	974
Number of Runs	467
Z	1,304
Asymp. Sig. (2-tailed)	,192

a. Median

ASGR

Runs Test

	Return
Test Value ^a	,0000000
Cases < Test Value	414
Cases >= Test Value	560
Total Cases	974
Number of Runs	500
Z	1,505
Asymp. Sig. (2-tailed)	,132

a. Median

ISAT

Runs Test

	Return
Test Value ^a	,00000000
Cases < Test Value	431
Cases >= Test Value	543
Total Cases	974
Number of Runs	493
Z	,743
Asymp. Sig. (2-tailed)	,457

a. Median

MLPL

Runs Test

	Return
Test Value ^a	,000000000
Cases < Test Value	376
Cases >= Test Value	598
Total Cases	974
Number of Runs	474
Z	,764
Asymp. Sig. (2-tailed)	,445

a. Median

Keseluruhan

Runs Test

	Return
Test Value ^a	,000000000
Cases < Test Value	1976
Cases >= Test Value	2889
Total Cases	4865
Number of Runs	2401
Z	1,580
Asymp. Sig. (2-tailed)	,114

a. Median

LAMPIRAN 4

ASTRA GRAPHIA TBK

Date	Code	ClosingPrice	Volume	Return
1/4/2000	ASGR	6100	2142500	0.47878789
1/5/2000	ASGR	6450	2163500	0.05737705
1/6/2000	ASGR	9600	1350000	0.48837209
1/11/2000	ASGR	10000	4335500	0.04166667
1/12/2000	ASGR	9100	2058500	-0.09
1/13/2000	ASGR	7825	1300000	-0.1401099
1/14/2000	ASGR	6650	1753000	-0.1501597
1/17/2000	ASGR	7175	681500	0.07894737
1/18/2000	ASGR	7025	470500	-0.0209059
1/19/2000	ASGR	6500	692500	-0.0747331
1/20/2000	ASGR	7075	586500	0.08846154
1/21/2000	ASGR	7050	115500	-0.0035336
1/24/2000	ASGR	7025	379000	-0.0035461
1/26/2000	ASGR	8000	1522000	0.13879004
1/27/2000	ASGR	7925	643000	-0.009375
1/28/2000	ASGR	7825	250000	-0.0126183
1/31/2000	ASGR	8500	1134500	0.08626198
2/1/2000	ASGR	8075	1771500	-0.05
2/2/2000	ASGR	8150	801000	0.00928793
2/3/2000	ASGR	8200	359000	0.00613497
2/4/2000	ASGR	8225	133500	0.00304878
2/7/2000	ASGR	8325	212000	0.01215805
2/8/2000	ASGR	8250	276000	-0.009009
2/9/2000	ASGR	8400	337000	0.01818182
2/10/2000	ASGR	8350	363500	-0.0059524
2/11/2000	ASGR	8450	220500	0.01197605
2/14/2000	ASGR	8350	1278000	-0.0118343
2/15/2000	ASGR	8675	384000	0.03892216
2/16/2000	ASGR	8475	209000	-0.0230548
2/17/2000	ASGR	8375	331500	-0.0117994
2/18/2000	ASGR	8400	178000	0.00298507
2/21/2000	ASGR	8525	277000	0.01488095
2/22/2000	ASGR	8400	268500	-0.0146628
2/23/2000	ASGR	8500	264000	0.01190476
2/24/2000	ASGR	8450	214000	-0.0058824
2/25/2000	ASGR	8500	246000	0.00591716
2/28/2000	ASGR	8500	172500	0
3/1/2000	ASGR	8500	102000	0
3/2/2000	ASGR	8350	168500	-0.0176471
3/3/2000	ASGR	8100	15500	-0.0299401
3/6/2000	ASGR	8100	181000	0
3/7/2000	ASGR	1000	43801500	-0.8765432
3/8/2000	ASGR	975	14885500	-0.025
3/9/2000	ASGR	950	19021000	-0.025641
3/10/2000	ASGR	925	8729500	-0.0263158
3/13/2000	ASGR	950	7757500	0.02702703
3/14/2000	ASGR	900	2763000	-0.0526316

3/15/2000	ASGR	925	3450000	0.02777778
3/17/2000	ASGR	950	10736000	0.02702703
3/20/2000	ASGR	950	4489000	0
3/21/2000	ASGR	975	5303000	0.02631579
3/22/2000	ASGR	975	13689500	0
3/23/2000	ASGR	975	4682500	0
3/24/2000	ASGR	1000	10376000	0.02564103
3/27/2000	ASGR	975	4460500	-0.025
3/28/2000	ASGR	1000	8206500	0.02564103
3/29/2000	ASGR	1225	95056500	0.225
3/30/2000	ASGR	1100	54685500	-0.1020408
4/3/2000	ASGR	1075	10215500	-0.0227273
4/5/2000	ASGR	1050	11290500	-0.0232558
4/7/2000	ASGR	1075	7043000	0.02380952
4/10/2000	ASGR	1100	13378500	0.02325581
4/11/2000	ASGR	1175	15163000	0.06818182
4/12/2000	ASGR	1175	5694000	0
4/13/2000	ASGR	1150	3600000	-0.0212766
4/14/2000	ASGR	1150	3965000	0
4/17/2000	ASGR	1025	23732500	-0.1086957
4/18/2000	ASGR	1050	14576000	0.02439024
4/19/2000	ASGR	1050	8341500	0
4/20/2000	ASGR	1025	3258500	-0.0238095
4/24/2000	ASGR	1025	2111000	0
4/25/2000	ASGR	1000	4978000	-0.0243902
4/26/2000	ASGR	1000	7238500	0
4/27/2000	ASGR	975	1353000	-0.025
4/28/2000	ASGR	975	2085500	0
5/1/2000	ASGR	975	1551500	0
5/2/2000	ASGR	975	2872000	0
5/3/2000	ASGR	950	2014000	-0.025641
5/4/2000	ASGR	1000	2305500	0.05263158
5/5/2000	ASGR	1000	1092000	0
5/8/2000	ASGR	975	3473000	-0.025
5/9/2000	ASGR	975	287000	0
5/10/2000	ASGR	975	802000	0
5/11/2000	ASGR	950	1508000	-0.025641
5/12/2000	ASGR	925	976500	-0.0263158
5/15/2000	ASGR	900	1025000	-0.027027
5/16/2000	ASGR	775	5988000	-0.1388889
5/17/2000	ASGR	825	7545000	0.06451613
5/19/2000	ASGR	800	1873500	-0.030303
5/22/2000	ASGR	800	309000	0
5/23/2000	ASGR	750	4003000	-0.0625
5/24/2000	ASGR	700	4551000	-0.0666667
5/25/2000	ASGR	725	2639500	0.03571429
5/26/2000	ASGR	700	3429000	-0.0344828
5/29/2000	ASGR	625	2156000	-0.1071429
5/30/2000	ASGR	600	6686500	-0.04
5/31/2000	ASGR	600	3782000	0

6/2/2000	ASGR	575	1584500	-0.0416667
6/5/2000	ASGR	600	1145000	0.04347826
6/6/2000	ASGR	600	871000	0
6/7/2000	ASGR	625	4866000	0.04166667
6/8/2000	ASGR	675	12994500	0.08
6/9/2000	ASGR	650	2915000	-0.037037
6/12/2000	ASGR	625	910000	-0.0384615
6/13/2000	ASGR	600	625000	-0.04
6/14/2000	ASGR	625	2891000	0.04166667
6/16/2000	ASGR	675	4299000	0.08
6/19/2000	ASGR	675	6100000	0
6/20/2000	ASGR	675	2323500	0
6/21/2000	ASGR	700	14403000	0.03703704
6/22/2000	ASGR	725	9709000	0.03571429
6/23/2000	ASGR	725	1558500	0
6/26/2000	ASGR	750	10309500	0.03448276
6/27/2000	ASGR	725	2188000	-0.0333333
6/28/2000	ASGR	700	1137000	-0.0344828
6/29/2000	ASGR	725	451000	0.03571429
6/30/2000	ASGR	725	202000	0
7/3/2000	ASGR	680	1218000	-0.062069
7/4/2000	ASGR	690	1048000	0.01470588
7/5/2000	ASGR	685	945500	-0.0072464
7/6/2000	ASGR	680	563000	-0.0072993
7/7/2000	ASGR	680	294000	0
7/10/2000	ASGR	680	364500	0
7/11/2000	ASGR	690	731000	0.01470588
7/12/2000	ASGR	690	258000	0
7/13/2000	ASGR	690	1603500	0
7/14/2000	ASGR	680	663000	-0.0144928
7/17/2000	ASGR	690	365000	0.01470588
7/18/2000	ASGR	685	199000	-0.0072464
7/19/2000	ASGR	695	1808500	0.01459854
7/20/2000	ASGR	690	1049500	-0.0071942
7/21/2000	ASGR	685	340000	-0.0072464
7/24/2000	ASGR	685	202500	0
7/25/2000	ASGR	675	379000	-0.0145985
7/26/2000	ASGR	675	148500	0
7/27/2000	ASGR	675	294500	0
7/28/2000	ASGR	675	71500	0
7/31/2000	ASGR	665	663000	-0.0148148
8/1/2000	ASGR	645	1092500	-0.0300752
8/2/2000	ASGR	635	673500	-0.0155039
8/3/2000	ASGR	650	1057000	0.02362205
8/4/2000	ASGR	650	1598500	0
8/7/2000	ASGR	645	324500	-0.0076923
8/8/2000	ASGR	630	652000	-0.0232558
8/9/2000	ASGR	605	1583000	-0.0396825
8/10/2000	ASGR	625	6105500	0.03305785
8/11/2000	ASGR	655	6588000	0.048

8/14/2000	ASGR	650	3067000	-0.0076336
8/15/2000	ASGR	645	4175500	-0.0076923
8/16/2000	ASGR	645	982000	0
8/18/2000	ASGR	645	641500	0
8/21/2000	ASGR	645	914500	0
8/22/2000	ASGR	665	11192500	0.03100775
8/23/2000	ASGR	675	5766000	0.01503759
8/24/2000	ASGR	645	8796500	-0.0444444
8/25/2000	ASGR	645	2714500	0
8/28/2000	ASGR	640	2375500	-0.0077519
8/29/2000	ASGR	630	991500	-0.015625
8/30/2000	ASGR	630	2933000	0
8/31/2000	ASGR	620	1567500	-0.015873
9/1/2000	ASGR	625	767000	0.00806452
9/4/2000	ASGR	640	735500	0.024
9/5/2000	ASGR	635	969000	-0.0078125
9/6/2000	ASGR	625	1478000	-0.015748
9/7/2000	ASGR	630	489500	0.008
9/8/2000	ASGR	625	221500	-0.0079365
9/11/2000	ASGR	605	273500	-0.032
9/12/2000	ASGR	595	573500	-0.0165289
9/13/2000	ASGR	570	453500	-0.0420168
9/18/2000	ASGR	525	944000	-0.0789474
9/19/2000	ASGR	545	1827000	0.03809524
9/20/2000	ASGR	540	1617500	-0.0091743
9/21/2000	ASGR	530	653000	-0.0185185
9/22/2000	ASGR	510	787000	-0.0377358
9/25/2000	ASGR	505	716000	-0.0098039
9/26/2000	ASGR	500	394000	-0.009901
9/27/2000	ASGR	495	598000	-0.01
9/28/2000	ASGR	495	1560500	0
9/29/2000	ASGR	490	1519500	-0.010101
10/2/2000	ASGR	495	1467500	0.01020408
10/3/2000	ASGR	490	1040500	-0.010101
10/4/2000	ASGR	485	318500	-0.0102041
10/5/2000	ASGR	485	4144000	0
10/6/2000	ASGR	490	377500	0.01030928
10/9/2000	ASGR	480	594000	-0.0204082
10/10/2000	ASGR	480	204000	0
10/11/2000	ASGR	480	685000	0
10/12/2000	ASGR	475	578500	-0.0104167
10/13/2000	ASGR	465	565000	-0.0210526
10/16/2000	ASGR	460	721000	-0.0107527
10/17/2000	ASGR	475	2721000	0.0326087
10/18/2000	ASGR	475	2674500	0
10/19/2000	ASGR	480	497000	0.01052632
10/20/2000	ASGR	475	749000	-0.0104167
10/23/2000	ASGR	470	341500	-0.0105263
10/24/2000	ASGR	470	387500	0
10/26/2000	ASGR	460	132000	-0.0212766

10/27/2000	ASGR	460	104500	0
10/30/2000	ASGR	450	476000	-0.0217391
10/31/2000	ASGR	440	208500	-0.0222222
11/1/2000	ASGR	445	161500	0.01136364
11/2/2000	ASGR	440	154000	-0.011236
11/3/2000	ASGR	445	145000	0.01136364
11/6/2000	ASGR	455	428500	0.02247191
11/7/2000	ASGR	455	77000	0
11/8/2000	ASGR	455	385000	0
11/9/2000	ASGR	455	127000	0
11/10/2000	ASGR	455	125000	0
11/13/2000	ASGR	450	110500	-0.010989
11/14/2000	ASGR	450	155500	0
11/15/2000	ASGR	450	255000	0
11/16/2000	ASGR	445	38500	-0.0111111
11/17/2000	ASGR	455	2699500	0.02247191
11/20/2000	ASGR	460	3548000	0.01098901
11/21/2000	ASGR	455	393500	-0.0108696
11/22/2000	ASGR	455	1764500	0
11/23/2000	ASGR	460	1020000	0.01098901
11/24/2000	ASGR	460	595500	0
11/27/2000	ASGR	450	145500	-0.0217391
11/28/2000	ASGR	440	919000	-0.0222222
11/29/2000	ASGR	445	151000	0.01136364
11/30/2000	ASGR	455	3919500	0.02247191
12/1/2000	ASGR	455	639000	0
12/4/2000	ASGR	445	691500	-0.021978
12/5/2000	ASGR	445	417500	0
12/6/2000	ASGR	445	1703500	0
12/7/2000	ASGR	445	115000	0
12/8/2000	ASGR	445	241000	0
1/2/2001	ASGR	410	153500	-0.0786517
1/3/2001	ASGR	400	222500	-0.0243902
1/4/2001	ASGR	400	54000	0
1/5/2001	ASGR	400	520500	0
1/8/2001	ASGR	395	207500	-0.0125
1/9/2001	ASGR	390	806500	-0.0126582
1/10/2001	ASGR	390	42000	0
1/11/2001	ASGR	385	192500	-0.0128205
1/12/2001	ASGR	360	129000	-0.0649351
1/15/2001	ASGR	370	62500	0.02777778
1/16/2001	ASGR	365	284500	-0.0135135
1/17/2001	ASGR	360	432000	-0.0136986
1/18/2001	ASGR	355	1737500	-0.0138889
1/19/2001	ASGR	350	420000	-0.0140845
1/22/2001	ASGR	350	194000	0
1/23/2001	ASGR	340	446500	-0.0285714
1/24/2001	ASGR	340	526500	0
1/25/2001	ASGR	345	83500	0.01470588
1/26/2001	ASGR	340	170500	-0.0144928

1/29/2001	ASGR	340	117000	0
1/30/2001	ASGR	400	16275500	0.17647059
1/31/2001	ASGR	415	29008000	0.0375
2/1/2001	ASGR	400	7630500	-0.0361446
2/2/2001	ASGR	405	5886500	0.0125
2/5/2001	ASGR	405	3067000	0
2/6/2001	ASGR	395	1371500	-0.0246914
2/7/2001	ASGR	390	887000	-0.0126582
2/8/2001	ASGR	385	375000	-0.0128205
2/9/2001	ASGR	375	310500	-0.025974
2/12/2001	ASGR	365	314000	-0.0266667
2/13/2001	ASGR	365	424000	0
2/14/2001	ASGR	360	769000	-0.0136986
2/15/2001	ASGR	390	2932500	0.08333333
2/16/2001	ASGR	380	1268500	-0.025641
2/19/2001	ASGR	385	349000	0.01315789
2/20/2001	ASGR	385	624000	0
2/21/2001	ASGR	380	1223500	-0.012987
2/22/2001	ASGR	380	68000	0
2/23/2001	ASGR	380	223000	0
2/26/2001	ASGR	380	49500	0
2/27/2001	ASGR	365	266500	-0.0394737
2/28/2001	ASGR	345	833000	-0.0547945
3/1/2001	ASGR	345	1460000	0
3/2/2001	ASGR	345	330500	0
3/6/2001	ASGR	340	175000	-0.0144928
3/7/2001	ASGR	340	3435500	0
3/8/2001	ASGR	335	2688000	-0.0147059
3/9/2001	ASGR	325	681000	-0.0298507
3/12/2001	ASGR	290	864000	-0.1076923
3/13/2001	ASGR	275	1097000	-0.0517241
3/14/2001	ASGR	285	714500	0.03636364
3/15/2001	ASGR	290	434000	0.01754386
3/16/2001	ASGR	275	139500	-0.0517241
3/19/2001	ASGR	240	325000	-0.1272727
3/20/2001	ASGR	225	322000	-0.0625
3/21/2001	ASGR	225	1842000	0
3/22/2001	ASGR	230	1784000	0.02222222
3/23/2001	ASGR	235	815000	0.02173913
3/27/2001	ASGR	225	357000	-0.0425532
3/28/2001	ASGR	230	202500	0.02222222
3/29/2001	ASGR	225	739500	-0.0217391
3/30/2001	ASGR	210	1292500	-0.0666667
4/2/2001	ASGR	205	919500	-0.0238095
4/3/2001	ASGR	180	1367000	-0.1219512
4/4/2001	ASGR	220	1983500	0.22222222
4/5/2001	ASGR	210	30306000	-0.0454545
4/6/2001	ASGR	205	9221000	-0.0238095
4/9/2001	ASGR	205	1285000	0
4/10/2001	ASGR	210	3932000	0.02439024

4/11/2001	ASGR	210	3116000	0
4/12/2001	ASGR	215	4974500	0.02380952
4/16/2001	ASGR	210	1004000	-0.0232558
4/17/2001	ASGR	200	616500	-0.047619
4/18/2001	ASGR	195	702500	-0.025
4/19/2001	ASGR	175	1911500	-0.1025641
4/20/2001	ASGR	150	5460500	-0.1428571
4/23/2001	ASGR	155	7383500	0.03333333
4/24/2001	ASGR	165	8468500	0.06451613
4/25/2001	ASGR	185	16396000	0.12121212
4/26/2001	ASGR	175	3457000	-0.0540541
4/27/2001	ASGR	180	7957500	0.02857143
4/30/2001	ASGR	190	12459500	0.05555556
5/1/2001	ASGR	190	29930000	0
5/2/2001	ASGR	195	8881500	0.02631579
5/3/2001	ASGR	205	22531000	0.05128205
5/4/2001	ASGR	210	11406000	0.02439024
5/8/2001	ASGR	200	5821000	-0.047619
5/9/2001	ASGR	200	3553500	0
5/10/2001	ASGR	195	5939000	-0.025
5/11/2001	ASGR	195	1879500	0
5/14/2001	ASGR	195	579000	0
5/15/2001	ASGR	200	1039500	0.02564103
5/16/2001	ASGR	215	29227000	0.075
5/17/2001	ASGR	215	8018500	0
5/18/2001	ASGR	210	3001000	-0.0232558
5/21/2001	ASGR	215	2846500	0.02380952
5/22/2001	ASGR	215	1790000	0
5/23/2001	ASGR	215	1975500	0
5/25/2001	ASGR	220	6388500	0.02325581
5/28/2001	ASGR	220	4936500	0
5/29/2001	ASGR	250	31804000	0.13636364
5/30/2001	ASGR	240	41976000	-0.04
5/31/2001	ASGR	245	15427500	0.02083333
6/1/2001	ASGR	235	10387000	-0.0408163
6/5/2001	ASGR	235	12984500	0
6/6/2001	ASGR	235	8722000	0
6/7/2001	ASGR	230	2771000	-0.0212766
6/8/2001	ASGR	225	2054500	-0.0217391
6/11/2001	ASGR	235	6256500	0.04444444
6/12/2001	ASGR	255	18953000	0.08510638
6/13/2001	ASGR	245	10313500	-0.0392157
6/14/2001	ASGR	250	4679500	0.02040816
6/15/2001	ASGR	245	742000	-0.02
6/18/2001	ASGR	250	1337500	0.02040816
6/19/2001	ASGR	285	36076500	0.14
6/20/2001	ASGR	305	33607000	0.07017544
6/21/2001	ASGR	305	20494000	0
6/22/2001	ASGR	300	5836000	-0.0163934
6/25/2001	ASGR	290	4776500	-0.03333333

6/26/2001	ASGR	295	3265500	0.01724138
6/27/2001	ASGR	295	7910000	0
6/28/2001	ASGR	295	3523500	0
6/29/2001	ASGR	300	4206500	0.01694915
7/2/2001	ASGR	295	1923000	-0.0166667
7/3/2001	ASGR	310	18879500	0.05084746
7/4/2001	ASGR	310	14440000	0
7/5/2001	ASGR	310	5105500	0
7/6/2001	ASGR	310	2115500	0
7/9/2001	ASGR	305	4090000	-0.016129
7/10/2001	ASGR	320	34903000	0.04918033
7/11/2001	ASGR	320	12567000	0
7/12/2001	ASGR	315	5115500	-0.015625
7/13/2001	ASGR	320	4787000	0.01587302
7/16/2001	ASGR	315	2590000	-0.015625
7/17/2001	ASGR	320	3632500	0.01587302
7/18/2001	ASGR	435	113888000	0.359375
7/19/2001	ASGR	475	149105000	0.09195402
7/20/2001	ASGR	460	69642000	-0.0315789
7/23/2001	ASGR	495	80526500	0.07608696
7/24/2001	ASGR	470	48166500	-0.0505051
7/25/2001	ASGR	470	61195500	0
7/26/2001	ASGR	460	35601500	-0.0212766
7/27/2001	ASGR	460	13579500	0
7/30/2001	ASGR	470	11481500	0.02173913
7/31/2001	ASGR	455	6702000	-0.0319149
8/1/2001	ASGR	465	7893000	0.02197802
8/2/2001	ASGR	445	4523000	-0.0430108
8/3/2001	ASGR	425	12660500	-0.0449438
8/6/2001	ASGR	420	8926000	-0.0117647
8/7/2001	ASGR	440	28705500	0.04761905
8/8/2001	ASGR	470	40062000	0.06818182
8/9/2001	ASGR	435	65083500	-0.0744681
8/10/2001	ASGR	460	31692000	0.05747126
8/13/2001	ASGR	475	27641000	0.0326087
8/14/2001	ASGR	470	23344000	-0.0105263
8/15/2001	ASGR	455	8948000	-0.0319149
8/16/2001	ASGR	455	4541500	0
8/20/2001	ASGR	465	4588500	0.02197802
8/21/2001	ASGR	465	8511500	0
8/22/2001	ASGR	465	3370500	0
8/23/2001	ASGR	455	4287000	-0.0215054
8/24/2001	ASGR	460	3108000	0.01098901
8/27/2001	ASGR	455	3442500	-0.0108696
8/28/2001	ASGR	445	9818500	-0.021978
8/29/2001	ASGR	430	4134000	-0.0337079
8/30/2001	ASGR	455	7276000	0.05813953
8/31/2001	ASGR	450	5957500	-0.010989
9/3/2001	ASGR	435	9161000	-0.0333333
9/4/2001	ASGR	445	10304500	0.02298851

9/5/2001	ASGR	440	5225000	-0.011236
9/6/2001	ASGR	440	7662000	0
9/7/2001	ASGR	440	1759000	0
9/10/2001	ASGR	440	4811000	0
9/11/2001	ASGR	440	5527000	0
9/12/2001	ASGR	415	18880500	-0.0568182
9/13/2001	ASGR	415	6310500	0
9/14/2001	ASGR	395	6625000	-0.0481928
9/17/2001	ASGR	355	11945500	-0.1012658
9/18/2001	ASGR	355	12024500	0
9/19/2001	ASGR	380	18526000	0.07042254
9/20/2001	ASGR	380	19229000	0
9/21/2001	ASGR	365	7818000	-0.0394737
9/24/2001	ASGR	360	8054500	-0.0136986
9/25/2001	ASGR	360	10924000	0
9/26/2001	ASGR	340	9175000	-0.0555556
9/27/2001	ASGR	335	8039000	-0.0147059
9/28/2001	ASGR	335	6757000	0
10/1/2001	ASGR	320	13360500	-0.0447761
10/2/2001	ASGR	305	10216500	-0.046875
10/3/2001	ASGR	305	12711500	0
10/4/2001	ASGR	330	33777500	0.08196721
10/5/2001	ASGR	325	14696500	-0.0151515
10/8/2001	ASGR	300	14961000	-0.0769231
10/9/2001	ASGR	310	13426000	0.03333333
10/10/2001	ASGR	310	1831500	0
10/11/2001	ASGR	310	4956000	0
10/12/2001	ASGR	320	9936000	0.03225806
10/16/2001	ASGR	310	2282500	-0.03125
10/17/2001	ASGR	315	8239000	0.01612903
10/18/2001	ASGR	390	86603000	0.23809524
10/19/2001	ASGR	385	33350500	-0.0128205
10/22/2001	ASGR	395	19102500	0.02597403
10/23/2001	ASGR	395	5684500	0
10/24/2001	ASGR	375	6725500	-0.0506329
10/25/2001	ASGR	375	6893500	0
10/26/2001	ASGR	375	5762000	0
10/29/2001	ASGR	365	4542500	-0.0266667
10/30/2001	ASGR	370	9051000	0.01369863
10/31/2001	ASGR	370	4184000	0
11/1/2001	ASGR	370	4365000	0
11/2/2001	ASGR	365	13638500	-0.0135135
11/5/2001	ASGR	355	3554000	-0.0273973
11/6/2001	ASGR	370	4714000	0.04225352
11/7/2001	ASGR	380	16189500	0.02702703
11/8/2001	ASGR	390	11350000	0.02631579
11/9/2001	ASGR	390	8560000	0
11/12/2001	ASGR	375	1413000	-0.0384615
11/13/2001	ASGR	380	3066000	0.01333333
11/14/2001	ASGR	385	12442000	0.01315789

11/15/2001	ASGR	385	1814500	0
11/16/2001	ASGR	385	2985500	0
11/19/2001	ASGR	385	2493500	0
11/20/2001	ASGR	375	1129500	-0.025974
11/21/2001	ASGR	380	3245500	0.01333333
11/22/2001	ASGR	380	194500	0
11/23/2001	ASGR	380	3577000	0
11/26/2001	ASGR	375	379000	-0.0131579
11/27/2001	ASGR	370	367500	-0.01333333
11/28/2001	ASGR	375	2764500	0.01351351
11/29/2001	ASGR	370	1698000	-0.01333333
11/30/2001	ASGR	360	444000	-0.027027
12/3/2001	ASGR	360	1782000	0
12/4/2001	ASGR	360	208000	0
12/5/2001	ASGR	360	358500	0
12/6/2001	ASGR	360	698000	0
12/7/2001	ASGR	355	142500	-0.0138889
12/10/2001	ASGR	355	260000	0
12/11/2001	ASGR	355	75000	0
12/12/2001	ASGR	360	671500	0.01408451
12/13/2001	ASGR	355	2726000	-0.0138889
12/19/2001	ASGR	360	777500	0.01408451
12/20/2001	ASGR	370	2800000	0.02777778
12/21/2001	ASGR	375	1923000	0.01351351
12/26/2001	ASGR	370	274000	-0.01333333
12/27/2001	ASGR	365	948500	-0.0135135
12/28/2001	ASGR	360	1070500	-0.0136986
12/10/2001	ASGR	355	260000	-0.0138889
12/11/2001	ASGR	355	75000	0
12/12/2001	ASGR	360	671500	0.01408451
12/13/2001	ASGR	355	2726000	-0.0138889
12/19/2001	ASGR	360	777500	0.01408451
12/20/2001	ASGR	370	2800000	0.02777778
12/21/2001	ASGR	375	1923000	0.01351351
12/26/2001	ASGR	370	274000	-0.01333333
12/27/2001	ASGR	365	948500	-0.0135135
12/28/2001	ASGR	360	1070500	-0.0136986
1/2/2002	ASGR	350	2081000	-0.0277778
1/3/2002	ASGR	370	7739500	0.05714286
1/4/2002	ASGR	365	4483000	-0.0135135
1/7/2002	ASGR	375	4234000	0.02739726
1/8/2002	ASGR	370	934500	-0.01333333
1/9/2002	ASGR	375	3913500	0.01351351
1/10/2002	ASGR	380	1432000	0.01333333
1/11/2002	ASGR	380	12173500	0
1/14/2002	ASGR	385	3346000	0.01315789
1/15/2002	ASGR	400	11364000	0.03896104
1/16/2002	ASGR	395	19938000	-0.0125
1/17/2002	ASGR	395	2291500	0
1/18/2002	ASGR	390	1230000	-0.0126582

1/21/2002	ASGR	390	665000	0
1/22/2002	ASGR	385	1114000	-0.0128205
1/23/2002	ASGR	395	2990000	0.02597403
1/24/2002	ASGR	395	19986000	0
1/25/2002	ASGR	395	4606500	0
1/28/2002	ASGR	395	3329000	0
1/29/2002	ASGR	405	21016500	0.02531646
1/30/2002	ASGR	405	2005000	0
1/31/2002	ASGR	425	13154500	0.04938272
2/1/2002	ASGR	405	10617000	-0.0470588
2/4/2002	ASGR	405	4496500	0
2/5/2002	ASGR	405	1611000	0
2/6/2002	ASGR	405	973000	0
2/7/2002	ASGR	410	3301500	0.01234568
2/8/2002	ASGR	420	6659000	0.02439024
2/11/2002	ASGR	410	4957500	-0.0238095
2/13/2002	ASGR	410	85000	0
2/14/2002	ASGR	405	1123000	-0.0121951
2/15/2002	ASGR	410	1227500	0.01234568
2/18/2002	ASGR	410	3742000	0
2/19/2002	ASGR	405	1683000	-0.0121951
2/20/2002	ASGR	415	5786500	0.02469136
2/21/2002	ASGR	415	2616000	0
2/25/2002	ASGR	405	487500	-0.0240964
2/26/2002	ASGR	405	363500	0
2/27/2002	ASGR	405	390000	0
2/28/2002	ASGR	400	1060500	-0.0123457
3/1/2002	ASGR	395	4363000	-0.0125
3/4/2002	ASGR	405	1891000	0.02531646
3/5/2002	ASGR	405	447000	0
3/6/2002	ASGR	410	2208000	0.01234568
3/7/2002	ASGR	410	4839500	0
3/8/2002	ASGR	410	932000	0
3/11/2002	ASGR	405	1667500	-0.0121951
3/12/2002	ASGR	400	925000	-0.0123457
3/13/2002	ASGR	410	1808500	0.025
3/14/2002	ASGR	400	443000	-0.0243902
3/18/2002	ASGR	400	3559000	0
3/19/2002	ASGR	395	529000	-0.0125
3/20/2002	ASGR	405	544000	0.02531646
3/21/2002	ASGR	400	5340000	-0.0123457
3/22/2002	ASGR	400	372500	0
3/25/2002	ASGR	405	3460000	0.0125
3/26/2002	ASGR	405	177500	0
3/27/2002	ASGR	400	80000	-0.0123457
3/28/2002	ASGR	395	3374500	-0.0125
4/1/2002	ASGR	400	367500	0.01265823
4/2/2002	ASGR	405	3272500	0.0125
4/3/2002	ASGR	405	121000	0
4/4/2002	ASGR	410	5502500	0.01234568

4/5/2002	ASGR	420	13338500	0.02439024
4/8/2002	ASGR	420	6180000	0
4/9/2002	ASGR	415	2094500	-0.0119048
4/10/2002	ASGR	460	30390000	0.10843373
4/11/2002	ASGR	440	26701500	-0.0434783
4/12/2002	ASGR	520	43297000	0.18181818
4/15/2002	ASGR	550	32175500	0.05769231
4/16/2002	ASGR	550	13046000	0
4/17/2002	ASGR	500	14672500	-0.0909091
4/18/2002	ASGR	500	7356500	0
4/19/2002	ASGR	525	2706500	0.05
4/22/2002	ASGR	500	2328000	-0.047619
4/23/2002	ASGR	525	1605500	0.05
4/24/2002	ASGR	525	1689000	0
4/25/2002	ASGR	525	8037000	0
4/26/2002	ASGR	475	761000	-0.0952381
4/29/2002	ASGR	470	7247000	-0.0105263
4/30/2002	ASGR	480	4951500	0.0212766
5/1/2002	ASGR	480	2073000	0
5/2/2002	ASGR	475	544000	-0.0104167
5/3/2002	ASGR	470	5041000	-0.0105263
5/6/2002	ASGR	480	7653500	0.0212766
5/7/2002	ASGR	485	2467000	0.01041667
5/8/2002	ASGR	480	10695000	-0.0103093
5/10/2002	ASGR	470	3681500	-0.0208333
5/13/2002	ASGR	460	2079000	-0.0212766
5/14/2002	ASGR	460	2821500	0
5/15/2002	ASGR	460	3197000	0
5/16/2002	ASGR	445	5157000	-0.0326087
5/17/2002	ASGR	435	3014000	-0.0224719
5/20/2002	ASGR	430	1395500	-0.0114943
5/21/2002	ASGR	425	615000	-0.0116279
5/22/2002	ASGR	415	1993000	-0.0235294
5/23/2002	ASGR	400	4176500	-0.0361446
5/24/2002	ASGR	405	822500	0.0125
5/27/2002	ASGR	415	986500	0.02469136
5/28/2002	ASGR	415	1343000	0
5/29/2002	ASGR	425	3374500	0.02409639
5/30/2002	ASGR	445	9523000	0.04705882
5/31/2002	ASGR	480	48061500	0.07865169
6/3/2002	ASGR	470	19172500	-0.0208333
6/4/2002	ASGR	465	11939500	-0.0106383
6/5/2002	ASGR	465	5759500	0
6/6/2002	ASGR	450	4521000	-0.0322581
6/7/2002	ASGR	450	3574000	0
6/10/2002	ASGR	445	656000	-0.0111111
6/11/2002	ASGR	460	2742500	0.03370787
6/12/2002	ASGR	460	7139000	0
6/13/2002	ASGR	475	10672500	0.0326087
6/14/2002	ASGR	470	7086000	-0.0105263

6/17/2002	ASGR	475	1269500	0.0106383
6/18/2002	ASGR	465	4305500	-0.0210526
6/19/2002	ASGR	460	2894000	-0.0107527
6/20/2002	ASGR	455	1701000	-0.0108696
6/21/2002	ASGR	450	370500	-0.010989
6/24/2002	ASGR	440	2740000	-0.0222222
6/25/2002	ASGR	450	5077500	0.02272727
6/26/2002	ASGR	420	3177500	-0.0666667
6/27/2002	ASGR	435	1788500	0.03571429
6/28/2002	ASGR	430	3933000	-0.0114943
7/1/2002	ASGR	415	2022500	-0.0348837
7/2/2002	ASGR	415	4181500	0
7/3/2002	ASGR	405	1871000	-0.0240964
7/4/2002	ASGR	415	1533000	0.02469136
7/5/2002	ASGR	410	5584000	-0.0120482
7/8/2002	ASGR	400	1855000	-0.0243902
7/9/2002	ASGR	400	3932000	0
7/10/2002	ASGR	400	932500	0
7/11/2002	ASGR	390	2398500	-0.025
7/12/2002	ASGR	410	3773000	0.05128205
7/15/2002	ASGR	400	1085500	-0.0243902
7/16/2002	ASGR	400	1944500	0
7/17/2002	ASGR	400	4288500	0
7/18/2002	ASGR	405	3054500	0.0125
7/19/2002	ASGR	400	3933500	-0.0123457
7/22/2002	ASGR	380	7449000	-0.05
7/23/2002	ASGR	375	4268500	-0.0131579
7/24/2002	ASGR	360	3280000	-0.04
7/25/2002	ASGR	355	4027500	-0.0138889
7/26/2002	ASGR	335	2759000	-0.056338
7/29/2002	ASGR	340	4213500	0.01492537
7/30/2002	ASGR	355	8230000	0.04411765
7/31/2002	ASGR	345	5080000	-0.028169
8/1/2002	ASGR	325	5615500	-0.057971
8/2/2002	ASGR	330	3788000	0.01538462
8/5/2002	ASGR	325	548000	-0.0151515
8/6/2002	ASGR	315	2698000	-0.0307692
8/7/2002	ASGR	330	2619500	0.04761905
8/8/2002	ASGR	320	6849000	-0.030303
8/9/2002	ASGR	320	2527500	0
8/12/2002	ASGR	325	2684000	0.015625
8/13/2002	ASGR	330	1816000	0.01538462
8/14/2002	ASGR	325	698000	-0.0151515
8/15/2002	ASGR	325	385000	0
8/16/2002	ASGR	325	2300500	0
8/19/2002	ASGR	330	517500	0.01538462
8/20/2002	ASGR	350	11819000	0.06060606
8/21/2002	ASGR	355	11769500	0.01428571
8/22/2002	ASGR	340	5006000	-0.0422535
8/23/2002	ASGR	350	2860500	0.02941176

8/26/2002	ASGR	345	1012500	-0.0142857
8/27/2002	ASGR	335	607500	-0.0289855
8/28/2002	ASGR	320	2558000	-0.0447761
8/29/2002	ASGR	320	1449000	0
8/30/2002	ASGR	330	360000	0.03125
9/2/2002	ASGR	325	322000	-0.0151515
9/3/2002	ASGR	320	505500	-0.0153846
9/4/2002	ASGR	320	1066000	0
9/5/2002	ASGR	330	8693000	0.03125
9/6/2002	ASGR	330	1561500	0
9/9/2002	ASGR	325	739000	-0.0151515
9/10/2002	ASGR	325	682500	0
9/11/2002	ASGR	325	155000	0
9/12/2002	ASGR	320	155000	-0.0153846
9/13/2002	ASGR	315	976000	-0.015625
9/16/2002	ASGR	315	258500	0
9/17/2002	ASGR	325	1110000	0.03174603
9/18/2002	ASGR	320	432000	-0.0153846
9/19/2002	ASGR	300	2698000	-0.0625
9/20/2002	ASGR	300	1575500	0
9/23/2002	ASGR	300	1780000	0
9/24/2002	ASGR	300	2004500	0
9/25/2002	ASGR	305	2331500	0.01666667
9/26/2002	ASGR	300	3145500	-0.0163934
9/27/2002	ASGR	295	805000	-0.0166667
9/30/2002	ASGR	285	660000	-0.0338983
10/1/2002	ASGR	290	210500	0.01754386
10/2/2002	ASGR	280	863000	-0.0344828
10/3/2002	ASGR	275	1088500	-0.0178571
10/7/2002	ASGR	265	310000	-0.0363636
10/8/2002	ASGR	265	1208000	0
10/9/2002	ASGR	260	470500	-0.0188679
10/10/2002	ASGR	255	1074000	-0.0192308
10/11/2002	ASGR	245	576500	-0.0392157
10/14/2002	ASGR	190	2244500	-0.2244898
10/15/2002	ASGR	205	2390500	0.07894737
10/16/2002	ASGR	220	5323000	0.07317073
10/17/2002	ASGR	210	1069500	-0.0454545
10/18/2002	ASGR	230	9652500	0.0952381
10/21/2002	ASGR	235	3040500	0.02173913
10/22/2002	ASGR	230	2999000	-0.0212766
10/23/2002	ASGR	240	499500	0.04347826
10/24/2002	ASGR	235	31500	-0.0208333
10/25/2002	ASGR	235	175500	0
10/28/2002	ASGR	245	800000	0.04255319
10/29/2002	ASGR	250	3504500	0.02040816
10/30/2002	ASGR	255	1449000	0.02
10/31/2002	ASGR	260	3593500	0.01960784
11/1/2002	ASGR	260	3518000	0
11/4/2002	ASGR	265	1856500	0.01923077

11/5/2002	ASGR	265	11135500	0
11/6/2002	ASGR	255	2448000	-0.0377358
11/7/2002	ASGR	255	3854000	0
11/8/2002	ASGR	255	1982500	0
11/11/2002	ASGR	255	1074500	0
11/12/2002	ASGR	260	1526000	0.01960784
11/13/2002	ASGR	260	1854500	0
11/14/2002	ASGR	260	357500	0
11/15/2002	ASGR	260	1208000	0
11/18/2002	ASGR	250	4912000	-0.0384615
11/19/2002	ASGR	250	3653000	0
11/20/2002	ASGR	245	1834500	-0.02
11/21/2002	ASGR	250	487500	0.02040816
11/22/2002	ASGR	260	3195000	0.04
11/25/2002	ASGR	255	4143000	-0.0192308
11/26/2002	ASGR	250	463500	-0.0196078
11/27/2002	ASGR	250	726000	0
11/28/2002	ASGR	255	176500	0.02
11/29/2002	ASGR	250	40000	-0.0196078
12/2/2002	ASGR	245	260000	-0.02
12/3/2002	ASGR	255	407500	0.04081633
12/4/2002	ASGR	250	711000	-0.0196078
12/11/2002	ASGR	245	39000	-0.02
12/12/2002	ASGR	250	280500	0.02040816
12/13/2002	ASGR	245	147500	-0.02
12/16/2002	ASGR	245	157500	0
12/17/2002	ASGR	245	257500	0
12/18/2002	ASGR	250	1493500	0.02040816
12/19/2002	ASGR	285	9398500	0.14
12/20/2002	ASGR	280	6901500	-0.0175439
12/23/2002	ASGR	285	3615500	0.01785714
12/27/2002	ASGR	275	992500	-0.0350877
1/2/2003	ASGR	260	567500	-0.0545455
1/3/2003	ASGR	265	708000	0.01923077
1/6/2003	ASGR	250	1170500	-0.0566038
1/7/2003	ASGR	245	452500	-0.02
1/8/2003	ASGR	235	917000	-0.0408163
1/9/2003	ASGR	250	1339000	0.06382979
1/10/2003	ASGR	250	1359000	0
1/13/2003	ASGR	250	329000	0
1/14/2003	ASGR	265	3004000	0.06
1/15/2003	ASGR	260	5107500	-0.0188679
1/16/2003	ASGR	280	12431000	0.07692308
1/17/2003	ASGR	280	5588500	0
1/20/2003	ASGR	275	1754000	-0.0178571
1/21/2003	ASGR	270	807500	-0.0181818
1/22/2003	ASGR	270	581500	0
1/23/2003	ASGR	270	62500	0
1/24/2003	ASGR	265	211000	-0.0185185
1/27/2003	ASGR	255	980500	-0.0377358

1/28/2003	ASGR	265	791500	0.03921569
1/29/2003	ASGR	255	325000	-0.0377358
1/30/2003	ASGR	255	550000	0
1/31/2003	ASGR	255	247500	0
2/3/2003	ASGR	255	292500	0
2/4/2003	ASGR	260	888500	0.01960784
2/5/2003	ASGR	255	131500	-0.0192308
2/6/2003	ASGR	260	932500	0.01960784
2/7/2003	ASGR	255	790000	-0.0192308
2/9/2003	ASGR	320	1190000	0.25490196
2/10/2003	ASGR	255	50000	-0.203125
2/11/2003	ASGR	255	350500	0
2/13/2003	ASGR	260	66000	0.01960784
2/14/2003	ASGR	260	647000	0
2/17/2003	ASGR	270	1994000	0.03846154
2/18/2003	ASGR	260	2256500	-0.037037
2/19/2003	ASGR	260	554000	0
2/20/2003	ASGR	255	899000	-0.0192308
2/21/2003	ASGR	255	288500	0
2/24/2003	ASGR	260	3500	0.01960784
2/25/2003	ASGR	250	2402500	-0.0384615
2/26/2003	ASGR	250	130500	0
2/27/2003	ASGR	255	34000	0.02
2/28/2003	ASGR	255	337000	0
3/4/2003	ASGR	250	407500	-0.0196078
3/5/2003	ASGR	255	665000	0.02
3/6/2003	ASGR	255	325000	0
3/7/2003	ASGR	250	342500	-0.0196078
3/9/2003	ASGR	345	30671500	0.38
3/10/2003	ASGR	250	777000	-0.2753623
3/11/2003	ASGR	240	880500	-0.04
3/12/2003	ASGR	245	312500	0.02083333
3/13/2003	ASGR	250	192500	0.02040816
3/14/2003	ASGR	245	149000	-0.02
3/17/2003	ASGR	245	237500	0
3/18/2003	ASGR	245	320000	0
3/19/2003	ASGR	245	237500	0
3/20/2003	ASGR	255	1905000	0.04081633
3/21/2003	ASGR	255	1237000	0
3/24/2003	ASGR	255	2027500	0
3/25/2003	ASGR	250	463500	-0.0196078
3/26/2003	ASGR	260	1510500	0.04
3/27/2003	ASGR	295	25229500	0.13461538
3/28/2003	ASGR	285	6620500	-0.0338983
3/31/2003	ASGR	270	4062000	-0.0526316
4/1/2003	ASGR	270	2630500	0
4/3/2003	ASGR	275	3043500	0.01851852
4/4/2003	ASGR	280	3298500	0.01818182
4/7/2003	ASGR	290	9325500	0.03571429
4/8/2003	ASGR	285	4311500	-0.0172414

4/9/2003	ASGR	300	24920500	0.05263158
4/10/2003	ASGR	300	6684000	0
4/11/2003	ASGR	300	9549500	0
4/14/2003	ASGR	290	3832000	-0.0333333
4/15/2003	ASGR	295	2932500	0.01724138
4/16/2003	ASGR	305	18169500	0.03389831
4/17/2003	ASGR	310	5357000	0.01639344
4/21/2003	ASGR	315	3786000	0.01612903
4/22/2003	ASGR	295	5947000	-0.0634921
4/23/2003	ASGR	360	25020500	0.22033898
4/24/2003	ASGR	345	12869500	-0.0416667
4/25/2003	ASGR	325	15507000	-0.057971
4/28/2003	ASGR	330	6348500	0.01538462
4/29/2003	ASGR	360	17577500	0.09090909
4/30/2003	ASGR	355	13354000	-0.0138889
5/1/2003	ASGR	355	5073000	0
5/2/2003	ASGR	345	3816000	-0.028169
5/5/2003	ASGR	355	6573500	0.02898551
5/6/2003	ASGR	360	14235500	0.01408451
5/7/2003	ASGR	360	9588000	0
5/8/2003	ASGR	355	5398500	-0.0138889
5/9/2003	ASGR	350	3272500	-0.0140845
5/12/2003	ASGR	355	1289500	0.01428571
5/13/2003	ASGR	345	1308500	-0.028169
5/14/2003	ASGR	340	966500	-0.0144928
5/19/2003	ASGR	315	3183000	-0.0735294
5/20/2003	ASGR	335	4716000	0.06349206
5/21/2003	ASGR	330	2036500	-0.0149254
5/22/2003	ASGR	345	6857500	0.04545455
5/23/2003	ASGR	345	3064500	0
5/26/2003	ASGR	360	4358000	0.04347826
5/27/2003	ASGR	355	1484000	-0.0138889
5/28/2003	ASGR	360	8632500	0.01408451
5/29/2003	ASGR	360	14888500	0
6/2/2003	ASGR	365	2315000	0.01388889
6/3/2003	ASGR	360	2138500	-0.0136986
6/4/2003	ASGR	370	13510000	0.02777778
6/5/2003	ASGR	375	23130000	0.01351351
6/6/2003	ASGR	375	3255000	0
6/9/2003	ASGR	390	12173000	0.04
6/10/2003	ASGR	385	2498500	-0.0128205
6/11/2003	ASGR	370	6899500	-0.038961
6/12/2003	ASGR	365	2921500	-0.0135135
6/13/2003	ASGR	370	1768500	0.01369863
6/16/2003	ASGR	370	520000	0
6/17/2003	ASGR	360	2329500	-0.027027
6/18/2003	ASGR	345	2831000	-0.0416667
6/19/2003	ASGR	355	1301500	0.02898551
6/20/2003	ASGR	355	1909000	0
6/23/2003	ASGR	350	847500	-0.0140845

6/24/2003	ASGR	340	1547000	-0.0285714
6/25/2003	ASGR	340	1516500	0
6/26/2003	ASGR	330	4201500	-0.0294118
6/27/2003	ASGR	330	2659000	0
6/30/2003	ASGR	325	532500	-0.0151515
7/1/2003	ASGR	315	1167500	-0.0307692
7/2/2003	ASGR	320	560000	0.01587302
7/3/2003	ASGR	325	2051500	0.015625
7/4/2003	ASGR	320	54000	-0.0153846
7/7/2003	ASGR	335	680500	0.046875
7/8/2003	ASGR	340	3677500	0.01492537
7/9/2003	ASGR	345	2517500	0.01470588
7/10/2003	ASGR	340	949000	-0.0144928
7/11/2003	ASGR	350	4057000	0.02941176
7/14/2003	ASGR	355	6193000	0.01428571
7/15/2003	ASGR	345	4854000	-0.028169
7/16/2003	ASGR	335	445500	-0.0289855
7/17/2003	ASGR	340	1173500	0.01492537
7/18/2003	ASGR	340	93000	0
7/21/2003	ASGR	335	870500	-0.0147059
7/22/2003	ASGR	330	1981000	-0.0149254
7/23/2003	ASGR	325	435500	-0.0151515
7/24/2003	ASGR	315	2354500	-0.0307692
7/25/2003	ASGR	320	1713500	0.01587302
7/28/2003	ASGR	315	536500	-0.015625
7/29/2003	ASGR	320	289500	0.01587302
7/30/2003	ASGR	320	1167500	0
7/31/2003	ASGR	315	1245500	-0.015625
8/1/2003	ASGR	320	1900000	0.01587302
8/4/2003	ASGR	330	5801500	0.03125
8/5/2003	ASGR	315	2690000	-0.0454545
8/6/2003	ASGR	315	1169500	0
8/7/2003	ASGR	335	3792500	0.06349206
8/8/2003	ASGR	330	3708000	-0.0149254
8/9/2003	ASGR	340	10986000	0.03030303
8/11/2003	ASGR	330	475500	-0.0294118
8/12/2003	ASGR	325	226500	-0.0151515
8/13/2003	ASGR	320	1072000	-0.0153846
8/14/2003	ASGR	320	107000	0
8/15/2003	ASGR	320	1221500	0
8/19/2003	ASGR	325	549000	0.015625
8/20/2003	ASGR	320	399500	-0.0153846
8/21/2003	ASGR	325	752000	0.015625
8/22/2003	ASGR	320	276000	-0.0153846
8/25/2003	ASGR	325	845000	0.015625
8/26/2003	ASGR	325	35500	0
8/27/2003	ASGR	320	1378500	-0.0153846
8/28/2003	ASGR	320	1936000	0
8/29/2003	ASGR	320	716500	0
9/1/2003	ASGR	320	690000	0

9/2/2003	ASGR	320	1190000	0
9/3/2003	ASGR	345	30671500	0.078125
9/4/2003	ASGR	335	19245000	-0.0289855
9/5/2003	ASGR	335	6461500	0
9/8/2003	ASGR	340	10986000	0.01492537
9/9/2003	ASGR	355	32479500	0.04411765
9/10/2003	ASGR	360	28430000	0.01408451
9/11/2003	ASGR	355	9338000	-0.0138889
9/12/2003	ASGR	385	62304000	0.08450704
9/15/2003	ASGR	360	33225000	-0.0649351
9/16/2003	ASGR	370	21346000	0.02777778
9/17/2003	ASGR	365	12877000	-0.0135135
9/18/2003	ASGR	355	2754000	-0.0273973
9/19/2003	ASGR	355	785000	0
9/23/2003	ASGR	350	2454000	-0.0140845
9/24/2003	ASGR	355	6266500	0.01428571
9/25/2003	ASGR	380	48848500	0.07042254
9/26/2003	ASGR	375	62757500	-0.0131579
9/29/2003	ASGR	365	4962000	-0.0266667
9/30/2003	ASGR	370	4111500	0.01369863
10/1/2003	ASGR	370	4365000	0
10/2/2003	ASGR	370	5800000	0
10/3/2003	ASGR	370	3532500	0
10/6/2003	ASGR	360	2192500	-0.027027
10/7/2003	ASGR	365	1995500	0.01388889
10/8/2003	ASGR	375	31450000	0.02739726
10/9/2003	ASGR	375	7733500	0
10/10/2003	ASGR	370	8256000	-0.0133333
10/13/2003	ASGR	370	2705500	0
10/14/2003	ASGR	365	3914000	-0.0135135
10/15/2003	ASGR	380	7807500	0.04109589
10/16/2003	ASGR	375	7316500	-0.0131579
10/17/2003	ASGR	375	2728000	0
10/20/2003	ASGR	375	725000	0
10/21/2003	ASGR	370	10230000	-0.0133333
10/22/2003	ASGR	365	769000	-0.0135135
10/23/2003	ASGR	360	3559000	-0.0136986
10/24/2003	ASGR	355	1055000	-0.0138889
10/27/2003	ASGR	350	1928500	-0.0140845
10/28/2003	ASGR	335	3365500	-0.0428571
10/29/2003	ASGR	330	3982000	-0.0149254
10/30/2003	ASGR	325	726500	-0.0151515
10/31/2003	ASGR	330	2024000	0.01538462
11/3/2003	ASGR	330	807000	0
11/4/2003	ASGR	340	4950000	0.03030303
11/5/2003	ASGR	340	4695000	0
11/6/2003	ASGR	335	280000	-0.0147059
11/7/2003	ASGR	335	609000	0
11/10/2003	ASGR	325	520000	-0.0298507
11/11/2003	ASGR	335	1248500	0.03076923

11/12/2003	ASGR	335	492500	0
11/13/2003	ASGR	325	535000	-0.0298507
11/14/2003	ASGR	325	187500	0
11/17/2003	ASGR	320	426500	-0.0153846
11/18/2003	ASGR	325	813000	0.015625
11/19/2003	ASGR	320	407500	-0.0153846
11/20/2003	ASGR	320	810000	0
11/21/2003	ASGR	325	3782000	0.015625
12/1/2003	ASGR	330	2555000	0.01538462
12/2/2003	ASGR	325	1069500	-0.0151515
12/3/2003	ASGR	340	11804000	0.04615385
12/4/2003	ASGR	340	1691500	0
12/5/2003	ASGR	340	2721000	0
12/8/2003	ASGR	350	5132000	0.02941176
12/9/2003	ASGR	340	1498500	-0.0285714
12/10/2003	ASGR	335	2280000	-0.0147059
12/11/2003	ASGR	345	4505500	0.02985075
12/12/2003	ASGR	340	3166500	-0.0144928
12/15/2003	ASGR	340	1129500	0
12/16/2003	ASGR	335	900500	-0.0147059
12/17/2003	ASGR	335	135000	0
12/18/2003	ASGR	340	1884500	0.01492537
12/19/2003	ASGR	340	3105500	0
12/22/2003	ASGR	335	1828500	-0.0147059
12/23/2003	ASGR	335	2404000	0
12/29/2003	ASGR	335	801500	0
12/30/2003	ASGR	330	1158000	-0.0149254

INDOSAT TBK

Date	Code	Closing price	Volume	Return
1/4/2000	ISAT	16400	1302000	0.051282051
1/5/2000	ISAT	15000	2643500	-0.085365854
1/6/2000	ISAT	15350	627500	0.023333333
1/11/2000	ISAT	16250	2525500	0.058631922
1/12/2000	ISAT	16575	1107500	0.02
1/13/2000	ISAT	16625	772500	0.003016591
1/14/2000	ISAT	17425	1358500	0.048120301
1/17/2000	ISAT	18750	2102500	0.076040172
1/18/2000	ISAT	17500	830000	-0.066666667
1/19/2000	ISAT	17150	2208000	-0.02
1/20/2000	ISAT	17250	640500	0.005830904
1/21/2000	ISAT	16100	2162500	-0.066666667
1/24/2000	ISAT	15100	2273500	-0.062111801
1/26/2000	ISAT	14250	1254000	-0.056291391
1/27/2000	ISAT	14225	2162500	-0.001754386
1/28/2000	ISAT	14000	608500	-0.015817223
1/31/2000	ISAT	13700	810500	-0.021428571
2/1/2000	ISAT	13000	1424000	-0.051094891
2/2/2000	ISAT	13225	2079000	0.017307692
2/3/2000	ISAT	14200	2225500	0.073724008
2/4/2000	ISAT	14700	1119000	0.035211268
2/7/2000	ISAT	14700	602000	0
2/8/2000	ISAT	14300	595000	-0.027210884
2/9/2000	ISAT	14050	1383000	-0.017482517
2/10/2000	ISAT	14050	1119500	0
2/11/2000	ISAT	14500	1771000	0.03202847
2/14/2000	ISAT	14400	910000	-0.006896552
2/15/2000	ISAT	14600	466000	0.013888889
2/16/2000	ISAT	13800	1240500	-0.054794521
2/17/2000	ISAT	13450	1299500	-0.025362319
2/18/2000	ISAT	13600	1064000	0.011152416
2/21/2000	ISAT	13500	442000	-0.007352941
2/22/2000	ISAT	12950	1364000	-0.040740741
2/23/2000	ISAT	13300	881000	0.027027027
2/24/2000	ISAT	13175	921000	-0.009398496
2/25/2000	ISAT	13500	4321000	0.024667932
2/28/2000	ISAT	13400	524000	-0.007407407
3/1/2000	ISAT	13300	483500	-0.007462687
3/2/2000	ISAT	12825	1111000	-0.035714286
3/3/2000	ISAT	12400	2234500	-0.033138402
3/6/2000	ISAT	12525	2234000	0.010080645
3/7/2000	ISAT	12325	925500	-0.015968064
3/8/2000	ISAT	12400	948000	0.006085193
3/9/2000	ISAT	12375	1859500	-0.002016129
3/10/2000	ISAT	12550	4246500	0.014141414
3/13/2000	ISAT	12700	2343500	0.011952191
3/14/2000	ISAT	12800	681000	0.007874016

3/15/2000	ISAT	12625	566500	-0.013671875
3/17/2000	ISAT	12750	835500	0.00990099
3/20/2000	ISAT	12475	1388000	-0.021568627
3/21/2000	ISAT	12425	752000	-0.004008016
3/22/2000	ISAT	12525	1250000	0.00804829
3/23/2000	ISAT	12600	1574000	0.005988024
3/24/2000	ISAT	12575	768500	-0.001984127
3/27/2000	ISAT	12575	344000	0
3/28/2000	ISAT	12825	1117500	0.019880716
3/29/2000	ISAT	12925	1926500	0.007797271
3/30/2000	ISAT	12900	1347000	-0.001934236
4/3/2000	ISAT	12950	837500	0.003875969
4/5/2000	ISAT	12750	1269500	-0.015444015
4/7/2000	ISAT	12700	994000	-0.003921569
4/10/2000	ISAT	12525	988500	-0.013779528
4/11/2000	ISAT	12525	567000	0
4/12/2000	ISAT	12500	578000	-0.001996008
4/13/2000	ISAT	12250	640000	-0.02
4/14/2000	ISAT	11700	949000	-0.044897959
4/17/2000	ISAT	10400	1978500	-0.111111111
4/18/2000	ISAT	10150	2792500	-0.024038462
4/19/2000	ISAT	10300	1466500	0.014778325
4/20/2000	ISAT	10325	708000	0.002427184
4/24/2000	ISAT	10525	1135500	0.01937046
4/25/2000	ISAT	10475	492500	-0.004750594
4/26/2000	ISAT	11000	2084500	0.050119332
4/27/2000	ISAT	10675	891500	-0.029545455
4/28/2000	ISAT	10475	1590000	-0.018735363
5/1/2000	ISAT	10525	213500	0.00477327
5/2/2000	ISAT	10650	1200000	0.011876485
5/3/2000	ISAT	10750	1725000	0.009389671
5/4/2000	ISAT	10725	1480000	-0.002325581
5/5/2000	ISAT	10675	1586500	-0.004662005
5/8/2000	ISAT	10800	2031000	0.011709602
5/9/2000	ISAT	10800	3410500	0
5/10/2000	ISAT	10950	2505000	0.013888889
5/11/2000	ISAT	10600	1715500	-0.03196347
5/12/2000	ISAT	10500	1340500	-0.009433962
5/15/2000	ISAT	10425	969500	-0.007142857
5/16/2000	ISAT	9900	2608500	-0.050359712
5/17/2000	ISAT	10275	1606500	0.037878788
5/19/2000	ISAT	9975	975500	-0.02919708
5/22/2000	ISAT	10100	879000	0.012531328
5/23/2000	ISAT	9900	776000	-0.01980198
5/24/2000	ISAT	9850	302500	-0.005050505
5/25/2000	ISAT	9850	330500	0
5/26/2000	ISAT	9675	522000	-0.017766497
5/29/2000	ISAT	9350	709000	-0.033591731
5/30/2000	ISAT	9500	785000	0.016042781
5/31/2000	ISAT	9350	831500	-0.015789474

6/2/2000	ISAT	8850	1696500	-0.053475936
6/5/2000	ISAT	9075	552500	0.025423729
6/6/2000	ISAT	9200	568000	0.013774105
6/7/2000	ISAT	9150	235500	-0.005434783
6/8/2000	ISAT	9650	903500	0.054644809
6/9/2000	ISAT	10050	2000000	0.041450777
6/12/2000	ISAT	10550	3050500	0.049751244
6/13/2000	ISAT	10050	2818500	-0.047393365
6/14/2000	ISAT	9700	4366000	-0.034825871
6/16/2000	ISAT	10000	4202000	0.030927835
6/19/2000	ISAT	10075	1031500	0.0075
6/20/2000	ISAT	10300	1797000	0.022332506
6/21/2000	ISAT	10050	1785500	-0.024271845
6/22/2000	ISAT	10100	747000	0.004975124
6/23/2000	ISAT	9950	1707000	-0.014851485
6/26/2000	ISAT	10100	677500	0.015075377
6/27/2000	ISAT	9950	827500	-0.014851485
6/28/2000	ISAT	10025	200500	0.007537688
6/29/2000	ISAT	10300	3544500	0.027431421
6/30/2000	ISAT	10300	1775500	0
7/3/2000	ISAT	10200	1161000	-0.009708738
7/4/2000	ISAT	10225	579000	0.00245098
7/5/2000	ISAT	10275	553500	0.004889976
7/6/2000	ISAT	10300	429000	0.00243309
7/7/2000	ISAT	10075	259000	-0.02184466
7/10/2000	ISAT	10000	1350500	-0.007444169
7/11/2000	ISAT	10060	354500	0.006
7/12/2000	ISAT	10000	169000	-0.005964215
7/13/2000	ISAT	10025	567500	0.0025
7/14/2000	ISAT	9900	564500	-0.012468828
7/17/2000	ISAT	9825	405500	-0.007575758
7/18/2000	ISAT	9800	525500	-0.002544529
7/19/2000	ISAT	9835	1037500	0.003571429
7/20/2000	ISAT	9785	926000	-0.005083884
7/21/2000	ISAT	9540	2114000	-0.025038324
7/24/2000	ISAT	9600	239000	0.006289308
7/25/2000	ISAT	9455	823500	-0.015104167
7/26/2000	ISAT	9275	839000	-0.019037546
7/27/2000	ISAT	9375	300000	0.010781671
7/28/2000	ISAT	9205	600000	-0.018133333
7/31/2000	ISAT	9060	938000	-0.015752309
8/1/2000	ISAT	8955	1385000	-0.011589404
8/2/2000	ISAT	8960	728000	0.000558347
8/3/2000	ISAT	8925	1135500	-0.00390625
8/4/2000	ISAT	8680	2141000	-0.02745098
8/7/2000	ISAT	8520	1515000	-0.01843318
8/8/2000	ISAT	8565	1121500	0.00528169
8/9/2000	ISAT	8555	291000	-0.001167542
8/10/2000	ISAT	8635	1355000	0.009351257
8/11/2000	ISAT	9295	2680500	0.076433121

8/14/2000	ISAT	9100	1129500	-0.020979021
8/15/2000	ISAT	8800	1577500	-0.032967033
8/16/2000	ISAT	8800	1070500	0
8/18/2000	ISAT	8795	527500	-0.000568182
8/21/2000	ISAT	8660	718000	-0.01534963
8/22/2000	ISAT	8700	1147500	0.004618938
8/23/2000	ISAT	8670	1001000	-0.003448276
8/24/2000	ISAT	8230	1943000	-0.050749712
8/25/2000	ISAT	8405	722500	0.02126367
8/28/2000	ISAT	8100	1039500	-0.036287924
8/29/2000	ISAT	7820	1272000	-0.034567901
8/30/2000	ISAT	7600	1659500	-0.028132992
8/31/2000	ISAT	7450	1897000	-0.019736842
9/1/2000	ISAT	7460	1345500	0.001342282
9/4/2000	ISAT	7670	374500	0.028150134
9/5/2000	ISAT	7950	1357500	0.036505867
9/6/2000	ISAT	7775	1025000	-0.022012579
9/7/2000	ISAT	7610	595500	-0.021221865
9/8/2000	ISAT	7645	423000	0.004599212
9/11/2000	ISAT	7400	2153000	-0.03204709
9/12/2000	ISAT	7125	1531000	-0.037162162
9/13/2000	ISAT	7300	800000	0.024561404
9/18/2000	ISAT	6500	2345500	-0.109589041
9/19/2000	ISAT	6700	1164000	0.030769231
9/20/2000	ISAT	6900	2419000	0.029850746
9/21/2000	ISAT	6795	879000	-0.015217391
9/22/2000	ISAT	6635	738500	-0.023546726
9/25/2000	ISAT	6775	463000	0.021100226
9/26/2000	ISAT	6900	599000	0.018450185
9/27/2000	ISAT	6890	425500	-0.001449275
9/28/2000	ISAT	7100	1072000	0.030478955
9/29/2000	ISAT	7125	1138500	0.003521127
10/2/2000	ISAT	7350	754500	0.031578947
10/3/2000	ISAT	7450	724000	0.013605442
10/4/2000	ISAT	7250	193500	-0.026845638
10/5/2000	ISAT	7335	218000	0.011724138
10/6/2000	ISAT	7400	176000	0.008861622
10/9/2000	ISAT	7045	596000	-0.047972973
10/10/2000	ISAT	6890	1180000	-0.022001419
10/11/2000	ISAT	6800	1699500	-0.013062409
10/12/2000	ISAT	6510	1985500	-0.042647059
10/13/2000	ISAT	6600	836500	0.013824885
10/16/2000	ISAT	6700	2077500	0.015151515
10/17/2000	ISAT	6705	751000	0.000746269
10/18/2000	ISAT	6700	912000	-0.000745712
10/19/2000	ISAT	6700	1523500	0
10/20/2000	ISAT	6500	3277500	-0.029850746
10/23/2000	ISAT	6750	7694500	0.038461538
10/24/2000	ISAT	6850	1743000	0.014814815
10/26/2000	ISAT	6750	1118000	-0.01459854

10/27/2000	ISAT	6700	1992000	-0.007407407
10/30/2000	ISAT	6750	792500	0.007462687
10/31/2000	ISAT	6700	1798500	-0.007407407
11/1/2000	ISAT	6650	886000	-0.007462687
11/2/2000	ISAT	6700	545500	0.007518797
11/3/2000	ISAT	6950	3671500	0.037313433
11/6/2000	ISAT	7100	4457000	0.021582734
11/7/2000	ISAT	7350	5817000	0.035211268
11/8/2000	ISAT	7600	8345000	0.034013605
11/9/2000	ISAT	7350	5815500	-0.032894737
11/10/2000	ISAT	7850	6474500	0.068027211
11/13/2000	ISAT	8400	11167000	0.070063694
11/14/2000	ISAT	8550	10176500	0.017857143
11/15/2000	ISAT	8750	13200000	0.023391813
11/16/2000	ISAT	8850	4068500	0.011428571
11/17/2000	ISAT	9250	11522000	0.04519774
11/20/2000	ISAT	9000	5818000	-0.027027027
11/21/2000	ISAT	9100	3718500	0.011111111
11/22/2000	ISAT	9050	2255000	-0.005494505
11/23/2000	ISAT	8800	3176500	-0.027624309
11/24/2000	ISAT	8800	1381000	0
11/27/2000	ISAT	9050	1984000	0.028409091
11/28/2000	ISAT	8950	2228000	-0.011049724
11/29/2000	ISAT	8950	917000	0
11/30/2000	ISAT	9000	1065000	0.005586592
12/1/2000	ISAT	8950	661500	-0.005555556
12/4/2000	ISAT	8950	571500	0
12/5/2000	ISAT	9000	1890000	0.005586592
12/6/2000	ISAT	9200	2904000	0.022222222
12/7/2000	ISAT	9150	1652000	-0.005434783
12/8/2000	ISAT	9150	2276000	0
12/11/2000	ISAT	9450	5323500	0.032786885
12/12/2000	ISAT	9400	2243500	-0.005291005
12/13/2000	ISAT	9250	1264500	-0.015957447
12/14/2000	ISAT	9150	1076500	-0.010810811
12/15/2000	ISAT	9200	1324000	0.005464481
12/18/2000	ISAT	9050	1292500	-0.016304348
12/19/2000	ISAT	8850	691500	-0.022099448
12/20/2000	ISAT	8950	785000	0.011299435
12/21/2000	ISAT	9000	314000	0.005586592
12/22/2000	ISAT	9000	451000	0
1/2/2001	ISAT	8950	582000	-0.005555556
1/3/2001	ISAT	8950	335500	0
1/4/2001	ISAT	9050	621500	0.011173184
1/5/2001	ISAT	9200	395000	0.016574586
1/8/2001	ISAT	9200	630500	0
1/9/2001	ISAT	9250	670500	0.005434783
1/10/2001	ISAT	9400	1759000	0.016216216
1/11/2001	ISAT	9050	1018500	-0.037234043
1/12/2001	ISAT	9100	682500	0.005524862

1/15/2001	ISAT	9150	540500	0.005494505
1/16/2001	ISAT	9100	4469500	-0.005464481
1/17/2001	ISAT	9100	1735000	0
1/18/2001	ISAT	9000	926000	-0.010989011
1/19/2001	ISAT	8800	1939000	-0.022222222
1/22/2001	ISAT	8950	1405000	0.017045455
1/23/2001	ISAT	8900	269000	-0.005586592
1/24/2001	ISAT	9050	752500	0.016853933
1/25/2001	ISAT	9200	1461500	0.016574586
1/26/2001	ISAT	9050	2034500	-0.016304348
1/29/2001	ISAT	8900	1875500	-0.016574586
1/30/2001	ISAT	8900	348500	0
1/31/2001	ISAT	9100	1805000	0.02247191
2/1/2001	ISAT	9100	2415500	0
2/2/2001	ISAT	9250	11480000	0.016483516
2/5/2001	ISAT	10300	17161000	0.113513514
2/6/2001	ISAT	9750	4727500	-0.053398058
2/7/2001	ISAT	9750	4109000	0
2/8/2001	ISAT	9750	1167500	0
2/9/2001	ISAT	9600	1682500	-0.015384615
2/12/2001	ISAT	9450	415000	-0.015625
2/13/2001	ISAT	9400	763500	-0.005291005
2/14/2001	ISAT	9350	618500	-0.005319149
2/15/2001	ISAT	10600	10503000	0.13368984
2/16/2001	ISAT	10150	6044000	-0.04245283
2/19/2001	ISAT	10500	3779000	0.034482759
2/20/2001	ISAT	10450	2481000	-0.004761905
2/21/2001	ISAT	10700	5182500	0.023923445
2/22/2001	ISAT	10550	939500	-0.014018692
2/23/2001	ISAT	10550	598000	0
2/26/2001	ISAT	10500	981500	-0.004739336
2/27/2001	ISAT	10550	1205500	0.004761905
2/28/2001	ISAT	10500	1725000	-0.004739336
3/1/2001	ISAT	10250	1168500	-0.023809524
3/2/2001	ISAT	10350	962000	0.009756098
3/6/2001	ISAT	10450	243000	0.009661836
3/7/2001	ISAT	10600	2236500	0.014354067
3/8/2001	ISAT	10450	751000	-0.014150943
3/9/2001	ISAT	10000	2013000	-0.043062201
3/12/2001	ISAT	9600	2536500	-0.04
3/13/2001	ISAT	9200	2023500	-0.041666667
3/14/2001	ISAT	9200	1285000	0
3/15/2001	ISAT	9000	1592500	-0.02173913
3/16/2001	ISAT	8800	1115000	-0.022222222
3/19/2001	ISAT	8150	1751500	-0.073863636
3/20/2001	ISAT	8100	729000	-0.006134969
3/21/2001	ISAT	8500	3172000	0.049382716
3/22/2001	ISAT	8100	1660000	-0.047058824
3/23/2001	ISAT	8100	3918000	0
3/27/2001	ISAT	7850	1907500	-0.030864198

3/28/2001	ISAT	7850	3207500	0
3/29/2001	ISAT	8100	2899500	0.031847134
3/30/2001	ISAT	8000	2806500	-0.012345679
4/2/2001	ISAT	7750	623000	-0.03125
4/3/2001	ISAT	7900	984000	0.019354839
4/4/2001	ISAT	7750	330000	-0.018987342
4/5/2001	ISAT	7700	719000	-0.006451613
4/6/2001	ISAT	7850	1179000	0.019480519
4/9/2001	ISAT	7750	429000	-0.012738854
4/10/2001	ISAT	7950	1227500	0.025806452
4/11/2001	ISAT	7900	1388500	-0.006289308
4/12/2001	ISAT	7900	604500	0
4/16/2001	ISAT	7850	128000	-0.006329114
4/17/2001	ISAT	7850	257000	0
4/18/2001	ISAT	7900	255500	0.006369427
4/19/2001	ISAT	7900	1630500	0
4/20/2001	ISAT	7850	1418000	-0.006329114
4/23/2001	ISAT	8000	1507500	0.01910828
4/24/2001	ISAT	7950	510500	-0.00625
4/25/2001	ISAT	8150	2509500	0.025157233
4/26/2001	ISAT	8100	1110500	-0.006134969
4/27/2001	ISAT	7900	3281000	-0.024691358
4/30/2001	ISAT	7950	1399500	0.006329114
5/1/2001	ISAT	8000	2420500	0.006289308
5/2/2001	ISAT	8000	931000	0
5/3/2001	ISAT	8650	9235500	0.08125
5/4/2001	ISAT	8750	6499000	0.011560694
5/8/2001	ISAT	8550	2431000	-0.022857143
5/9/2001	ISAT	8700	2709000	0.01754386
5/10/2001	ISAT	8500	5043000	-0.022988506
5/11/2001	ISAT	8550	2536000	0.005882353
5/14/2001	ISAT	8600	1185500	0.005847953
5/15/2001	ISAT	8600	649000	0
5/16/2001	ISAT	8800	2654000	0.023255814
5/17/2001	ISAT	8750	1193000	-0.005681818
5/18/2001	ISAT	8750	594000	0
5/21/2001	ISAT	8850	1232000	0.011428571
5/22/2001	ISAT	8750	631000	-0.011299435
5/23/2001	ISAT	8750	503500	0
5/25/2001	ISAT	9100	2924000	0.04
5/28/2001	ISAT	9200	3848500	0.010989011
5/29/2001	ISAT	9650	3000500	0.048913043
5/30/2001	ISAT	9650	4555500	0
5/31/2001	ISAT	9400	2220000	-0.025906736
6/1/2001	ISAT	9350	2057000	-0.005319149
6/5/2001	ISAT	9300	1182500	-0.005347594
6/6/2001	ISAT	9200	722500	-0.010752688
6/7/2001	ISAT	8950	2078500	-0.027173913
6/8/2001	ISAT	9050	609000	0.011173184
6/11/2001	ISAT	9500	2246000	0.049723757

6/12/2001	ISAT	9850	5954500	0.036842105
6/13/2001	ISAT	9550	3048500	-0.030456853
6/14/2001	ISAT	9600	3156000	0.005235602
6/15/2001	ISAT	9750	4123000	0.015625
6/18/2001	ISAT	9900	1572500	0.015384615
6/19/2001	ISAT	9950	1822500	0.005050505
6/20/2001	ISAT	10500	5110500	0.055276382
6/21/2001	ISAT	10650	11170000	0.014285714
6/22/2001	ISAT	10300	5800000	-0.03286385
6/25/2001	ISAT	10100	1553500	-0.019417476
6/26/2001	ISAT	10200	1040500	0.00990099
6/27/2001	ISAT	10150	1412500	-0.004901961
6/28/2001	ISAT	9800	4417500	-0.034482759
6/29/2001	ISAT	10150	3444000	0.035714286
7/2/2001	ISAT	10050	722000	-0.009852217
7/3/2001	ISAT	9900	801000	-0.014925373
7/4/2001	ISAT	9950	434000	0.005050505
7/5/2001	ISAT	10050	749000	0.010050251
7/6/2001	ISAT	10050	376000	0
7/9/2001	ISAT	10050	527500	0
7/10/2001	ISAT	10200	2393000	0.014925373
7/11/2001	ISAT	10100	855000	-0.009803922
7/12/2001	ISAT	10200	2765000	0.00990099
7/13/2001	ISAT	10350	2711500	0.014705882
7/16/2001	ISAT	10350	2441500	0
7/17/2001	ISAT	10350	2722000	0
7/18/2001	ISAT	10400	634000	0.004830918
7/19/2001	ISAT	11050	5738500	0.0625
7/20/2001	ISAT	11100	2505500	0.004524887
7/23/2001	ISAT	11150	6745000	0.004504505
7/24/2001	ISAT	10800	6563500	-0.031390135
7/25/2001	ISAT	10500	4626500	-0.027777778
7/26/2001	ISAT	10150	1836500	-0.033333333
7/27/2001	ISAT	10500	2371500	0.034482759
7/30/2001	ISAT	10500	1510500	0
7/31/2001	ISAT	10300	906500	-0.019047619
8/1/2001	ISAT	10300	1722500	0
8/2/2001	ISAT	10250	805500	-0.004854369
8/3/2001	ISAT	10400	442000	0.014634146
8/6/2001	ISAT	10200	259000	-0.019230769
8/7/2001	ISAT	10250	479000	0.004901961
8/8/2001	ISAT	10500	2581500	0.024390244
8/9/2001	ISAT	10100	2838000	-0.038095238
8/10/2001	ISAT	10100	1834500	0
8/13/2001	ISAT	10150	1422500	0.004950495
8/14/2001	ISAT	9900	3244500	-0.024630542
8/15/2001	ISAT	9450	3192500	-0.045454545
8/16/2001	ISAT	9400	977000	-0.005291005
8/20/2001	ISAT	9400	2786500	0
8/21/2001	ISAT	9400	1167000	0

8/22/2001	ISAT	9550	2463000	0.015957447
8/23/2001	ISAT	9300	2333000	-0.02617801
8/24/2001	ISAT	9300	1364500	0
8/27/2001	ISAT	9300	1659500	0
8/28/2001	ISAT	9350	1107500	0.005376344
8/29/2001	ISAT	9350	2145000	0
8/30/2001	ISAT	9350	1863500	0
8/31/2001	ISAT	9250	1832500	-0.010695187
9/3/2001	ISAT	9150	896000	-0.010810811
9/4/2001	ISAT	9500	2885500	0.038251366
9/5/2001	ISAT	9450	1306000	-0.005263158
9/6/2001	ISAT	9550	2271000	0.010582011
9/7/2001	ISAT	9300	1783000	-0.02617801
9/10/2001	ISAT	9300	194000	0
9/11/2001	ISAT	9500	2155500	0.021505376
9/12/2001	ISAT	9150	7056000	-0.036842105
9/13/2001	ISAT	9000	1298500	-0.016393443
9/14/2001	ISAT	8500	3691500	-0.055555556
9/17/2001	ISAT	8100	4788500	-0.047058824
9/18/2001	ISAT	8600	6079500	0.061728395
9/19/2001	ISAT	8600	1756000	0
9/20/2001	ISAT	8400	1285500	-0.023255814
9/21/2001	ISAT	8150	1390500	-0.029761905
9/24/2001	ISAT	8150	1105000	0
9/25/2001	ISAT	8050	1046000	-0.012269939
9/26/2001	ISAT	7950	1071500	-0.01242236
9/27/2001	ISAT	7900	1824500	-0.006289308
9/28/2001	ISAT	7750	1837500	-0.018987342
10/1/2001	ISAT	7700	838000	-0.006451613
10/2/2001	ISAT	7700	1334000	0
10/3/2001	ISAT	7750	2084000	0.006493506
10/4/2001	ISAT	7850	1333000	0.012903226
10/5/2001	ISAT	7800	525500	-0.006369427
10/8/2001	ISAT	7350	1481500	-0.057692308
10/9/2001	ISAT	7350	572000	0
10/10/2001	ISAT	7300	1080500	-0.006802721
10/11/2001	ISAT	7300	1360500	0
10/12/2001	ISAT	7600	2873000	0.04109589
10/16/2001	ISAT	7600	801000	0
10/17/2001	ISAT	7600	390000	0
10/18/2001	ISAT	7900	2437500	0.039473684
10/19/2001	ISAT	8100	3651500	0.025316456
10/22/2001	ISAT	8100	1558500	0
10/23/2001	ISAT	8200	2327500	0.012345679
10/24/2001	ISAT	8150	1734500	-0.006097561
10/25/2001	ISAT	8150	478000	0
10/26/2001	ISAT	8100	1248500	-0.006134969
10/29/2001	ISAT	8150	1023000	0.00617284
10/30/2001	ISAT	8250	3187000	0.012269939
10/31/2001	ISAT	8450	4288000	0.024242424

11/1/2001	ISAT	8500	1676000	0.00591716
11/2/2001	ISAT	8550	1227000	0.005882353
11/5/2001	ISAT	8350	1138500	-0.023391813
11/6/2001	ISAT	8550	1766000	0.023952096
11/7/2001	ISAT	8500	2061000	-0.005847953
11/8/2001	ISAT	8500	2396500	0
11/9/2001	ISAT	8400	1971500	-0.011764706
11/12/2001	ISAT	8400	1065000	0
11/13/2001	ISAT	8250	1244000	-0.017857143
11/14/2001	ISAT	8050	1758500	-0.024242424
11/15/2001	ISAT	8200	1315500	0.01863354
11/16/2001	ISAT	8300	1470500	0.012195122
11/19/2001	ISAT	8500	3228500	0.024096386
11/20/2001	ISAT	8700	4757500	0.023529412
11/21/2001	ISAT	8500	1536000	-0.022988506
11/22/2001	ISAT	8350	949000	-0.017647059
11/23/2001	ISAT	8500	863500	0.017964072
11/26/2001	ISAT	8400	303000	-0.011764706
11/27/2001	ISAT	8400	318500	0
11/28/2001	ISAT	8350	971000	-0.005952381
11/29/2001	ISAT	8450	1026000	0.011976048
11/30/2001	ISAT	8300	921000	-0.017751479
12/3/2001	ISAT	8350	533000	0.006024096
12/4/2001	ISAT	8350	379500	0
12/5/2001	ISAT	8400	238000	0.005988024
12/6/2001	ISAT	8300	283000	-0.011904762
12/7/2001	ISAT	8250	450000	-0.006024096
12/10/2001	ISAT	8200	243500	-0.006060606
12/11/2001	ISAT	8250	148500	0.006097561
12/12/2001	ISAT	8350	461500	0.012121212
12/13/2001	ISAT	8450	331000	0.011976048
12/19/2001	ISAT	8450	340500	0
12/20/2001	ISAT	8700	985500	0.029585799
12/21/2001	ISAT	9000	2624500	0.034482759
12/26/2001	ISAT	8900	245500	-0.011111111
12/27/2001	ISAT	9050	494500	0.016853933
12/28/2001	ISAT	9450	3829000	0.044198895
1/2/2002	ISAT	8950	818000	-0.052910053
1/3/2002	ISAT	8900	135000	-0.005586592
1/4/2002	ISAT	9100	1140500	0.02247191
1/7/2002	ISAT	9550	3129000	0.049450549
1/8/2002	ISAT	9500	2099000	-0.005235602
1/9/2002	ISAT	9450	855000	-0.005263158
1/10/2002	ISAT	9650	2351000	0.021164021
1/11/2002	ISAT	9850	5417500	0.020725389
1/14/2002	ISAT	9700	898500	-0.015228426
1/15/2002	ISAT	9800	1669500	0.010309278
1/16/2002	ISAT	9800	6393500	0
1/17/2002	ISAT	9700	662500	-0.010204082
1/18/2002	ISAT	9700	864500	0

1/21/2002	ISAT	9500	986500	-0.020618557
1/22/2002	ISAT	9450	702500	-0.005263158
1/23/2002	ISAT	9600	1245500	0.015873016
1/24/2002	ISAT	10150	7843000	0.057291667
1/25/2002	ISAT	10700	8008000	0.054187192
1/28/2002	ISAT	10200	3603000	-0.046728972
1/29/2002	ISAT	10450	2571500	0.024509804
1/30/2002	ISAT	10550	2817500	0.009569378
1/31/2002	ISAT	10650	4495500	0.009478673
2/1/2002	ISAT	10700	3545000	0.004694836
2/4/2002	ISAT	10400	691000	-0.028037383
2/5/2002	ISAT	10600	945000	0.019230769
2/6/2002	ISAT	10350	2174500	-0.023584906
2/7/2002	ISAT	9850	2581000	-0.048309179
2/8/2002	ISAT	10000	2259500	0.015228426
2/11/2002	ISAT	10350	667000	0.035
2/13/2002	ISAT	10050	2031500	-0.028985507
2/14/2002	ISAT	10200	2190500	0.014925373
2/15/2002	ISAT	10400	2406000	0.019607843
2/18/2002	ISAT	10700	4825000	0.028846154
2/19/2002	ISAT	10650	6267500	-0.004672897
2/20/2002	ISAT	10400	1199500	-0.023474178
2/21/2002	ISAT	10250	2360000	-0.014423077
2/25/2002	ISAT	10000	6571500	-0.024390244
2/26/2002	ISAT	9850	1545500	-0.015
2/27/2002	ISAT	10000	1176000	0.015228426
2/28/2002	ISAT	10000	2527000	0
3/1/2002	ISAT	10000	863500	0
3/4/2002	ISAT	9950	1435500	-0.005
3/5/2002	ISAT	10200	4616000	0.025125628
3/6/2002	ISAT	10300	3777500	0.009803922
3/7/2002	ISAT	10750	11143500	0.04368932
3/8/2002	ISAT	10650	2815000	-0.009302326
3/11/2002	ISAT	10800	2465500	0.014084507
3/12/2002	ISAT	10600	2311000	-0.018518519
3/13/2002	ISAT	10600	505500	0
3/14/2002	ISAT	10450	1921000	-0.014150943
3/18/2002	ISAT	10350	1231000	-0.009569378
3/19/2002	ISAT	10300	895500	-0.004830918
3/20/2002	ISAT	10200	1118500	-0.009708738
3/21/2002	ISAT	10350	1804000	0.014705882
3/22/2002	ISAT	10300	1129000	-0.004830918
3/25/2002	ISAT	10200	1720500	-0.009708738
3/26/2002	ISAT	10100	580000	-0.009803922
3/27/2002	ISAT	10050	3874000	-0.004950495
3/28/2002	ISAT	10150	2646000	0.009950249
4/1/2002	ISAT	10250	2137000	0.009852217
4/2/2002	ISAT	10250	3629500	0
4/3/2002	ISAT	10250	332500	0
4/4/2002	ISAT	10600	7900500	0.034146341

4/5/2002	ISAT	10950	10220000	0.033018868
4/8/2002	ISAT	11950	18757000	0.091324201
4/9/2002	ISAT	12800	13301500	0.071129707
4/10/2002	ISAT	13250	17280000	0.03515625
4/11/2002	ISAT	13000	10141000	-0.018867925
4/12/2002	ISAT	13400	9807500	0.030769231
4/15/2002	ISAT	13400	2604500	0
4/16/2002	ISAT	13650	7712500	0.018656716
4/17/2002	ISAT	12950	9697000	-0.051282051
4/18/2002	ISAT	12750	4391000	-0.015444015
4/19/2002	ISAT	12550	755500	-0.015686275
4/22/2002	ISAT	12550	1241000	0
4/23/2002	ISAT	12650	4345500	0.007968127
4/24/2002	ISAT	12950	4116000	0.023715415
4/25/2002	ISAT	13050	2707000	0.007722008
4/26/2002	ISAT	12800	1068000	-0.019157088
4/29/2002	ISAT	12550	1006500	-0.01953125
4/30/2002	ISAT	12750	1512500	0.015936255
5/1/2002	ISAT	12800	340500	0.003921569
5/2/2002	ISAT	13200	1873500	0.03125
5/3/2002	ISAT	13100	558500	-0.007575758
5/6/2002	ISAT	12850	571000	-0.019083969
5/7/2002	ISAT	13050	2191000	0.015564202
5/8/2002	ISAT	13350	4448000	0.022988506
5/10/2002	ISAT	13350	1196500	0
5/13/2002	ISAT	13150	722000	-0.014981273
5/14/2002	ISAT	12850	1699000	-0.022813688
5/15/2002	ISAT	13200	4722000	0.027237354
5/16/2002	ISAT	12600	10475500	-0.045454545
5/17/2002	ISAT	12600		0
5/20/2002	ISAT	11800	13558500	-0.063492063
5/21/2002	ISAT	12050	3213000	0.021186441
5/22/2002	ISAT	11900	6170000	-0.012448133
5/23/2002	ISAT	11700	1216000	-0.016806723
5/24/2002	ISAT	11600	1080500	-0.008547009
5/27/2002	ISAT	11700	541500	0.00862069
5/28/2002	ISAT	11750	941000	0.004273504
5/29/2002	ISAT	11700	1081500	-0.004255319
5/30/2002	ISAT	11650	1270500	-0.004273504
5/31/2002	ISAT	11750	4060000	0.008583691
6/3/2002	ISAT	11600	549000	-0.012765957
6/4/2002	ISAT	11450	1080000	-0.012931034
6/5/2002	ISAT	11750	2266500	0.026200873
6/6/2002	ISAT	11450	2513500	-0.025531915
6/7/2002	ISAT	11350	317000	-0.008733624
6/10/2002	ISAT	11300	121500	-0.004405286
6/11/2002	ISAT	11300	166000	0
6/12/2002	ISAT	11550	946000	0.022123894
6/13/2002	ISAT	11600	3188000	0.004329004
6/14/2002	ISAT	11450	2478500	-0.012931034

6/17/2002	ISAT	11400	383500	-0.004366812
6/18/2002	ISAT	11500	516500	0.00877193
6/19/2002	ISAT	11350	1034000	-0.013043478
6/20/2002	ISAT	11450	4752000	0.008810573
6/21/2002	ISAT	11250	702500	-0.017467249
6/24/2002	ISAT	11050	1830500	-0.017777778
6/25/2002	ISAT	10900	1033500	-0.013574661
6/26/2002	ISAT	10450	3474000	-0.041284404
6/27/2002	ISAT	10700	3405500	0.023923445
6/28/2002	ISAT	10950	3954000	0.023364486
7/1/2002	ISAT	10550	1366500	-0.03652968
7/2/2002	ISAT	10550	2448000	0
7/3/2002	ISAT	10450	987000	-0.009478673
7/4/2002	ISAT	10750	1206000	0.028708134
7/5/2002	ISAT	11000	1655500	0.023255814
7/8/2002	ISAT	10850	1024000	-0.013636364
7/9/2002	ISAT	10850	1386000	0
7/10/2002	ISAT	10350	1554000	-0.046082949
7/11/2002	ISAT	10150	713000	-0.019323671
7/12/2002	ISAT	10300	933000	0.014778325
7/15/2002	ISAT	10200	1906000	-0.009708738
7/16/2002	ISAT	9950	2792000	-0.024509804
7/17/2002	ISAT	10000	1763500	0.005025126
7/18/2002	ISAT	10000	1633500	0
7/19/2002	ISAT	9850	1890000	-0.015
7/22/2002	ISAT	9250	2680500	-0.060913706
7/23/2002	ISAT	9250	3031000	0
7/24/2002	ISAT	8650	4744500	-0.064864865
7/25/2002	ISAT	8700	5144500	0.005780347
7/26/2002	ISAT	8400	2569000	-0.034482759
7/29/2002	ISAT	8950	5043000	0.06547619
7/30/2002	ISAT	9000	5174500	0.005586592
7/31/2002	ISAT	9100	3380000	0.011111111
8/1/2002	ISAT	9250	5412500	0.016483516
8/2/2002	ISAT	9050	1364000	-0.021621622
8/5/2002	ISAT	8600	3498000	-0.049723757
8/6/2002	ISAT	8300	4102500	-0.034883721
8/7/2002	ISAT	8450	1746000	0.018072289
8/8/2002	ISAT	8500	1288000	0.00591716
8/9/2002	ISAT	8650	1393500	0.017647059
8/12/2002	ISAT	8600	600000	-0.005780347
8/13/2002	ISAT	8450	1029000	-0.01744186
8/14/2002	ISAT	8550	706000	0.01183432
8/15/2002	ISAT	8550	784000	0
8/16/2002	ISAT	8600	418000	0.005847953
8/19/2002	ISAT	8600	346000	0
8/20/2002	ISAT	8700	2123000	0.011627907
8/21/2002	ISAT	8950	2843500	0.028735632
8/22/2002	ISAT	9150	5527500	0.022346369
8/23/2002	ISAT	9800	7910000	0.071038251

8/26/2002	ISAT	9600	4749500	-0.020408163
8/27/2002	ISAT	9250	3360500	-0.036458333
8/28/2002	ISAT	8900	4332500	-0.037837838
8/29/2002	ISAT	8950	3183000	0.005617978
8/30/2002	ISAT	9150	1353000	0.022346369
9/2/2002	ISAT	9200	896500	0.005464481
9/3/2002	ISAT	8800	1777500	-0.043478261
9/4/2002	ISAT	8600	3352000	-0.022727273
9/5/2002	ISAT	8700	2865500	0.011627907
9/6/2002	ISAT	8700	1386000	0
9/9/2002	ISAT	8900	1215000	0.022988506
9/10/2002	ISAT	8900	3808000	0
9/11/2002	ISAT	8950	641500	0.005617978
9/12/2002	ISAT	8800	530000	-0.016759777
9/13/2002	ISAT	8600	2125500	-0.022727273
9/16/2002	ISAT	8650	505000	0.005813953
9/17/2002	ISAT	8950	1887000	0.034682081
9/18/2002	ISAT	8750	818000	-0.022346369
9/19/2002	ISAT	8650	1280500	-0.011428571
9/20/2002	ISAT	8650	886500	0
9/23/2002	ISAT	8650	230000	0
9/24/2002	ISAT	8650	908000	0
9/25/2002	ISAT	8600	1276000	-0.005780347
9/26/2002	ISAT	8650	708500	0.005813953
9/27/2002	ISAT	8650	1087500	0
9/30/2002	ISAT	8900	3639000	0.028901734
10/1/2002	ISAT	8450	377500	-0.050561798
10/2/2002	ISAT	8400	1262000	-0.00591716
10/3/2002	ISAT	8450	350500	0.005952381
10/7/2002	ISAT	8200	1281000	-0.029585799
10/8/2002	ISAT	8250	657500	0.006097561
10/9/2002	ISAT	7850	2744500	-0.048484848
10/10/2002	ISAT	7500	3501500	-0.044585987
10/11/2002	ISAT	7400	2177500	-0.013333333
10/14/2002	ISAT	6450	5473500	-0.128378378
10/15/2002	ISAT	6650	6920000	0.031007752
10/16/2002	ISAT	7000	6350500	0.052631579
10/17/2002	ISAT	6900	3149500	-0.014285714
10/18/2002	ISAT	6900	5358000	0
10/21/2002	ISAT	7050	3108000	0.02173913
10/22/2002	ISAT	7050	3636500	0
10/23/2002	ISAT	7650	12782000	0.085106383
10/24/2002	ISAT	7550	5913000	-0.013071895
10/25/2002	ISAT	7650	1639000	0.013245033
10/28/2002	ISAT	7850	1701500	0.026143791
10/29/2002	ISAT	7650	3243000	-0.025477707
10/30/2002	ISAT	7550	1807000	-0.013071895
10/31/2002	ISAT	7800	3558000	0.033112583
11/1/2002	ISAT	8000	6431000	0.025641026
11/4/2002	ISAT	8350	4080000	0.04375

11/5/2002	ISAT	8250	3356000	-0.011976048
11/6/2002	ISAT	8250	4746500	0
11/7/2002	ISAT	8500	4731500	0.03030303
11/8/2002	ISAT	8050	7348500	-0.052941176
11/11/2002	ISAT	7950	2033500	-0.01242236
11/12/2002	ISAT	8000	2095000	0.006289308
11/13/2002	ISAT	7700	4131500	-0.0375
11/14/2002	ISAT	7800	2643500	0.012987013
11/15/2002	ISAT	7950	2607000	0.019230769
11/18/2002	ISAT	7950	3143000	0
11/19/2002	ISAT	8000	891000	0.006289308
11/20/2002	ISAT	8050	2357500	0.00625
11/21/2002	ISAT	8000	1040500	-0.00621118
11/22/2002	ISAT	8050	2129000	0.00625
11/25/2002	ISAT	8000	2000500	-0.00621118
11/26/2002	ISAT	8000	2044000	0
11/27/2002	ISAT	8100	3817000	0.0125
11/28/2002	ISAT	8100	3766500	0
11/29/2002	ISAT	8350	10466500	0.030864198
12/2/2002	ISAT	8500	11184500	0.017964072
12/3/2002	ISAT	8650	11608500	0.017647059
12/4/2002	ISAT	8800	5462000	0.01734104
12/11/2002	ISAT	8600	6565500	-0.022727273
12/12/2002	ISAT	8700	7623500	0.011627907
12/13/2002	ISAT	8600	3801500	-0.011494253
12/16/2002	ISAT	8900	22541500	0.034883721
12/17/2002	ISAT	8800	7109500	-0.011235955
12/18/2002	ISAT	8750	3275500	-0.005681818
12/19/2002	ISAT	9100	6744000	0.04
12/20/2002	ISAT	9300	14047500	0.021978022
12/23/2002	ISAT	9150	4998500	-0.016129032
12/27/2002	ISAT	9250	9582000	0.010928962
1/2/2003	ISAT	8800	3643000	-0.048648649
1/3/2003	ISAT	8750	1805000	-0.005681818
1/6/2003	ISAT	8300	6923500	-0.051428571
1/7/2003	ISAT	8200	2181000	-0.012048193
1/8/2003	ISAT	8150	2176000	-0.006097561
1/9/2003	ISAT	8350	2269500	0.024539877
1/10/2003	ISAT	8250	2040000	-0.011976048
1/13/2003	ISAT	8250	1832000	0
1/14/2003	ISAT	8500	4066500	0.03030303
1/15/2003	ISAT	8400	3078500	-0.011764706
1/16/2003	ISAT	8250	3005500	-0.017857143
1/17/2003	ISAT	8250	1393500	0
1/20/2003	ISAT	8250	843000	0
1/21/2003	ISAT	8250	380000	0
1/22/2003	ISAT	8200	1230000	-0.006060606
1/23/2003	ISAT	8000	2616000	-0.024390244
1/24/2003	ISAT	7800	4339500	-0.025
1/27/2003	ISAT	7450	3709500	-0.044871795

1/28/2003	ISAT	7650	1569500	0.026845638
1/29/2003	ISAT	7400	2488000	-0.032679739
1/30/2003	ISAT	7450	1045500	0.006756757
1/31/2003	ISAT	7350	920500	-0.013422819
2/3/2003	ISAT	7350	630500	0
2/4/2003	ISAT	7450	1573000	0.013605442
2/5/2003	ISAT	7300	1392500	-0.020134228
2/6/2003	ISAT	7300	1022500	0
2/7/2003	ISAT	7250	1697000	-0.006849315
2/9/2003	ISAT	8150	1759000	0.124137931
2/10/2003	ISAT	7350	1870000	-0.098159509
2/11/2003	ISAT	7400	1945000	0.006802721
2/13/2003	ISAT	7500	1685000	0.013513514
2/14/2003	ISAT	7750	7678000	0.033333333
2/17/2003	ISAT	8000	6085500	0.032258065
2/18/2003	ISAT	8050	3319500	0.00625
2/19/2003	ISAT	8050	1959000	0
2/20/2003	ISAT	7900	1011500	-0.01863354
2/21/2003	ISAT	7900	1229500	0
2/24/2003	ISAT	7850	524500	-0.006329114
2/25/2003	ISAT	7900	2582500	0.006369427
2/26/2003	ISAT	7850	1385000	-0.006329114
2/27/2003	ISAT	7800	931000	-0.006369427
2/28/2003	ISAT	7850	1666000	0.006410256
3/4/2003	ISAT	8050	5070000	0.025477707
3/5/2003	ISAT	7950	1788500	-0.01242236
3/6/2003	ISAT	7900	236500	-0.006289308
3/7/2003	ISAT	7750	1516000	-0.018987342
3/9/2003	ISAT	8550	5314000	0.103225806
3/10/2003	ISAT	7350	3190500	-0.140350877
3/11/2003	ISAT	7450	1557000	0.013605442
3/12/2003	ISAT	7650	2394000	0.026845638
3/13/2003	ISAT	7500	1108500	-0.019607843
3/14/2003	ISAT	7700	2123000	0.026666667
3/17/2003	ISAT	7550	1224000	-0.019480519
3/18/2003	ISAT	7550	1129000	0
3/19/2003	ISAT	7650	1649500	0.013245033
3/20/2003	ISAT	7800	3662000	0.019607843
3/21/2003	ISAT	7700	830000	-0.012820513
3/24/2003	ISAT	7750	1535000	0.006493506
3/25/2003	ISAT	7700	1447500	-0.006451613
3/26/2003	ISAT	7750	2404000	0.006493506
3/27/2003	ISAT	7700	420500	-0.006451613
3/28/2003	ISAT	7800	1151000	0.012987013
3/31/2003	ISAT	7600	1588000	-0.025641026
4/1/2003	ISAT	7650	1153500	0.006578947
4/3/2003	ISAT	7700	335500	0.006535948
4/4/2003	ISAT	7750	994500	0.006493506
4/7/2003	ISAT	7950	6112500	0.025806452
4/8/2003	ISAT	7900	4747500	-0.006289308

4/9/2003	ISAT	8000	3200500	0.012658228
4/10/2003	ISAT	7950	1169500	-0.00625
4/11/2003	ISAT	8450	10925500	0.062893082
4/14/2003	ISAT	8600	8913000	0.017751479
4/15/2003	ISAT	8350	6637500	-0.029069767
4/16/2003	ISAT	8350	5812500	0
4/17/2003	ISAT	8500	5646000	0.017964072
4/21/2003	ISAT	8950	8424000	0.052941176
4/22/2003	ISAT	8800	4816000	-0.016759777
4/23/2003	ISAT	8900	1401000	0.011363636
4/24/2003	ISAT	9000	4512500	0.011235955
4/25/2003	ISAT	8650	3447000	-0.038888889
4/28/2003	ISAT	8450	2189000	-0.023121387
4/29/2003	ISAT	8700	2408500	0.029585799
4/30/2003	ISAT	8700	1909000	0
5/1/2003	ISAT	8600	1492500	-0.011494253
5/2/2003	ISAT	8450	1988500	-0.01744186
5/5/2003	ISAT	8650	1284500	0.023668639
5/6/2003	ISAT	8800	3715500	0.01734104
5/7/2003	ISAT	8700	5934000	-0.011363636
5/8/2003	ISAT	8900	7602000	0.022988506
5/9/2003	ISAT	8950	6074500	0.005617978
5/12/2003	ISAT	9000	2661500	0.005586592
5/13/2003	ISAT	8950	2919500	-0.005555556
5/14/2003	ISAT	8900	3115000	-0.005586592
5/19/2003	ISAT	8700	2425500	-0.02247191
5/20/2003	ISAT	8700	2457500	0
5/21/2003	ISAT	8650	2075000	-0.005747126
5/22/2003	ISAT	8600	1478000	-0.005780347
5/23/2003	ISAT	8700	1228000	0.011627907
5/26/2003	ISAT	8900	3684500	0.022988506
5/27/2003	ISAT	8900	1523500	0
5/28/2003	ISAT	9150	10103500	0.028089888
5/29/2003	ISAT	9350	14761500	0.021857923
6/2/2003	ISAT	9450	4574000	0.010695187
6/3/2003	ISAT	9350	5843000	-0.010582011
6/4/2003	ISAT	9300	980500	-0.005347594
6/5/2003	ISAT	9400	3471000	0.010752688
6/6/2003	ISAT	9400	2085000	0
6/9/2003	ISAT	9350	1604000	-0.005319149
6/10/2003	ISAT	9350	1074500	0
6/11/2003	ISAT	9250	1517000	-0.010695187
6/12/2003	ISAT	9150	3289500	-0.010810811
6/13/2003	ISAT	9300	1955500	0.016393443
6/16/2003	ISAT	9350	739500	0.005376344
6/17/2003	ISAT	9350	2303000	0
6/18/2003	ISAT	9100	1452000	-0.026737968
6/19/2003	ISAT	9250	427000	0.016483516
6/20/2003	ISAT	9250	508500	0
6/23/2003	ISAT	9050	1073000	-0.021621622

6/24/2003	ISAT	9050	982500	0
6/25/2003	ISAT	9050	180500	0
6/26/2003	ISAT	8900	1175000	-0.016574586
6/27/2003	ISAT	8950	893000	0.005617978
6/30/2003	ISAT	8800	834000	-0.016759777
7/1/2003	ISAT	8900	946500	0.011363636
7/2/2003	ISAT	8950	389500	0.005617978
7/3/2003	ISAT	8850	527000	-0.011173184
7/4/2003	ISAT	8800	697500	-0.005649718
7/7/2003	ISAT	8850	399500	0.005681818
7/8/2003	ISAT	9050	990500	0.02259887
7/9/2003	ISAT	8950	581000	-0.011049724
7/10/2003	ISAT	8900	608500	-0.005586592
7/11/2003	ISAT	8950	1313000	0.005617978
7/14/2003	ISAT	8850	1246500	-0.011173184
7/15/2003	ISAT	8800	282000	-0.005649718
7/16/2003	ISAT	8800	850000	0
7/17/2003	ISAT	8650	434000	-0.017045455
7/18/2003	ISAT	8750	559500	0.011560694
7/21/2003	ISAT	8750	253500	0
7/22/2003	ISAT	8650	763500	-0.011428571
7/23/2003	ISAT	8600	452000	-0.005780347
7/24/2003	ISAT	8450	1106500	-0.01744186
7/25/2003	ISAT	8300	734500	-0.017751479
7/28/2003	ISAT	8250	1076000	-0.006024096
7/29/2003	ISAT	8250	294000	0
7/30/2003	ISAT	8350	405000	0.012121212
7/31/2003	ISAT	8450	859500	0.011976048
8/1/2003	ISAT	8600	4871500	0.017751479
8/4/2003	ISAT	8350	1115500	-0.029069767
8/5/2003	ISAT	8000	6349000	-0.041916168
8/6/2003	ISAT	8000	3099500	0
8/7/2003	ISAT	8050	1079000	0.00625
8/8/2003	ISAT	8050	1981500	0
8/9/2003	ISAT	8850	1691500	0.099378882
8/11/2003	ISAT	8000	2172500	-0.096045198
8/12/2003	ISAT	8000	529500	0
8/13/2003	ISAT	8050	1299500	0.00625
8/14/2003	ISAT	8050	368500	0
8/15/2003	ISAT	8200	1046500	0.01863354
8/19/2003	ISAT	8300	2476000	0.012195122
8/20/2003	ISAT	8300	445500	0
8/21/2003	ISAT	8250	710000	-0.006024096
8/22/2003	ISAT	8250	1348000	0
8/25/2003	ISAT	8150	651000	-0.012121212
8/26/2003	ISAT	8150	1396500	0
8/27/2003	ISAT	8150	225500	0
8/28/2003	ISAT	8150	281000	0
8/29/2003	ISAT	8100	538000	-0.006134969
9/1/2003	ISAT	8050	1199500	-0.00617284

9/2/2003	ISAT	8150	1759000	0.01242236
9/3/2003	ISAT	8550	5314000	0.049079755
9/4/2003	ISAT	8800	5915500	0.029239766
9/5/2003	ISAT	8700	9435500	-0.011363636
9/8/2003	ISAT	8850	1691500	0.017241379
9/9/2003	ISAT	8850	2882000	0
9/10/2003	ISAT	8650	2625000	-0.02259887
9/11/2003	ISAT	8600	1080500	-0.005780347
9/12/2003	ISAT	9200	8880500	0.069767442
9/15/2003	ISAT	9350	5934000	0.016304348
9/16/2003	ISAT	9550	7051000	0.021390374
9/17/2003	ISAT	9550	4996000	0
9/18/2003	ISAT	9400	1772000	-0.015706806
9/19/2003	ISAT	9500	981000	0.010638298
9/23/2003	ISAT	9400	902000	-0.010526316
9/24/2003	ISAT	9500	3780000	0.010638298
9/25/2003	ISAT	9500	4273000	0
9/26/2003	ISAT	9450	1554000	-0.005263158
9/29/2003	ISAT	9400	1517500	-0.005291005
9/30/2003	ISAT	9400	1505000	0
10/1/2003	ISAT	9350	1518500	-0.005319149
10/2/2003	ISAT	9600	6101500	0.026737968
10/3/2003	ISAT	9500	2419500	-0.010416667
10/6/2003	ISAT	9550	1869000	0.005263158
10/7/2003	ISAT	9850	4534500	0.031413613
10/8/2003	ISAT	9800	2313500	-0.005076142
10/9/2003	ISAT	10250	6749000	0.045918367
10/10/2003	ISAT	10800	8393500	0.053658537
10/13/2003	ISAT	10600	1386000	-0.018518519
10/14/2003	ISAT	10500	2147000	-0.009433962
10/15/2003	ISAT	10900	4221500	0.038095238
10/16/2003	ISAT	11500	8620000	0.055045872
10/17/2003	ISAT	11300	2542000	-0.017391304
10/20/2003	ISAT	11300	1452500	0
10/21/2003	ISAT	11400	3002000	0.008849558
10/22/2003	ISAT	11750	4876500	0.030701754
10/23/2003	ISAT	11500	3962000	-0.021276596
10/24/2003	ISAT	11300	1181000	-0.017391304
10/27/2003	ISAT	11000	674500	-0.026548673
10/28/2003	ISAT	11350	2593000	0.031818182
10/29/2003	ISAT	11400	1819000	0.004405286
10/30/2003	ISAT	11500	1659500	0.00877193
10/31/2003	ISAT	11950	6336000	0.039130435
11/3/2003	ISAT	12100	4586000	0.012552301
11/4/2003	ISAT	12950	9277000	0.070247934
11/5/2003	ISAT	12600	1691500	-0.027027027
11/6/2003	ISAT	12150	1392500	-0.035714286
11/7/2003	ISAT	12500	1852000	0.028806584
11/10/2003	ISAT	12450	765000	-0.004
11/11/2003	ISAT	11950	2430000	-0.040160643

11/12/2003	ISAT	11650	2281500	-0.025104603
11/13/2003	ISAT	11500	1740000	-0.012875536
11/14/2003	ISAT	11400	254500	-0.008695652
11/17/2003	ISAT	11000	1193500	-0.035087719
11/18/2003	ISAT	10650	1351000	-0.031818182
11/19/2003	ISAT	10800	1791000	0.014084507
11/20/2003	ISAT	11400	1810500	0.055555556
11/21/2003	ISAT	11500	2104000	0.00877193
12/1/2003	ISAT	12200	3325500	0.060869565
12/2/2003	ISAT	12000	1527500	-0.016393443
12/3/2003	ISAT	12700	4903000	0.058333333
12/4/2003	ISAT	12600	547000	-0.007874016
12/5/2003	ISAT	12550	669500	-0.003968254
12/8/2003	ISAT	13150	5097500	0.047808765
12/9/2003	ISAT	13150	2267000	0
12/10/2003	ISAT	13400	2524500	0.019011407
12/11/2003	ISAT	13800	3238000	0.029850746
12/12/2003	ISAT	14600	6702000	0.057971014
12/15/2003	ISAT	14300	514000	-0.020547945
12/16/2003	ISAT	14250	1105000	-0.003496503
12/17/2003	ISAT	13850	1061000	-0.028070175
12/18/2003	ISAT	14200	1767500	0.025270758
12/19/2003	ISAT	14700	2956000	0.035211268
12/22/2003	ISAT	14500	1760000	-0.013605442
12/23/2003	ISAT	14600	1469000	0.006896552
12/29/2003	ISAT	15000	2473000	0.02739726
12/30/2003	ISAT	15000	2664000	0

MULTIPOLAR TBK

Date	Code	Closing price	Volume	Return
1/4/2000	MLPL	1300	95692500	0.061224489
1/5/2000	MLPL	1225	136702000	-0.05769231
1/6/2000	MLPL	1250	91611000	0.020408163
1/11/2000	MLPL	1200	86586500	-0.04
1/12/2000	MLPL	1175	83588000	-0.02083333
1/13/2000	MLPL	1200	63707500	0.021276596
1/14/2000	MLPL	1075	71679500	-0.10416667
1/17/2000	MLPL	1075	58760500	0
1/18/2000	MLPL	975	79279500	-0.09302326
1/19/2000	MLPL	725	226348000	-0.25641026
1/20/2000	MLPL	850	215759000	0.172413793
1/21/2000	MLPL	875	46068500	0.029411765
1/24/2000	MLPL	950	108564000	0.085714286
1/26/2000	MLPL	1075	146838000	0.131578947
1/27/2000	MLPL	1100	152912500	0.023255814
1/28/2000	MLPL	1050	69392500	-0.04545455
1/31/2000	MLPL	1025	42215000	-0.02380952
2/1/2000	MLPL	1025	40379000	0
2/2/2000	MLPL	1000	22449500	-0.02439024
2/3/2000	MLPL	975	8536500	-0.025
2/4/2000	MLPL	1050	23953500	0.076923077
2/7/2000	MLPL	1050	27223500	0
2/8/2000	MLPL	1000	7785000	-0.04761905
2/9/2000	MLPL	1050	13058000	0.05
2/10/2000	MLPL	1225	148279500	0.166666667
2/11/2000	MLPL	1150	34930500	-0.06122449
2/14/2000	MLPL	1125	27217500	-0.02173913
2/15/2000	MLPL	1125	27032500	0
2/16/2000	MLPL	1125	32311000	0
2/17/2000	MLPL	1125	25007500	0
2/18/2000	MLPL	1150	28433500	0.022222222
2/21/2000	MLPL	1275	77503500	0.108695652
2/22/2000	MLPL	1175	50794000	-0.07843137
2/23/2000	MLPL	1150	15802000	-0.0212766
2/24/2000	MLPL	1150	22887500	0
2/25/2000	MLPL	1125	13565500	-0.02173913
2/28/2000	MLPL	1100	7559500	-0.022222222
3/1/2000	MLPL	1050	12148000	-0.04545455
3/2/2000	MLPL	975	32762500	-0.07142857
3/3/2000	MLPL	950	17716000	-0.02564103
3/6/2000	MLPL	1075	37359500	0.131578947
3/7/2000	MLPL	1050	28459000	-0.02325581
3/8/2000	MLPL	1025	10382500	-0.02380952
3/9/2000	MLPL	1025	9228500	0
3/10/2000	MLPL	1050	6685500	0.024390244
3/13/2000	MLPL	975	7573000	-0.07142857
3/14/2000	MLPL	975	14235500	0

3/15/2000	MLPL	950	7417500	-0.02564103
3/17/2000	MLPL	950	7413500	0
3/20/2000	MLPL	900	19126500	-0.05263158
3/21/2000	MLPL	850	24325000	-0.05555556
3/22/2000	MLPL	850	17664500	0
3/23/2000	MLPL	875	9103000	0.029411765
3/24/2000	MLPL	850	5026500	-0.02857143
3/27/2000	MLPL	850	742500	0
3/28/2000	MLPL	850	1068000	0
3/29/2000	MLPL	900	13041000	0.058823529
3/30/2000	MLPL	900	36798500	0
4/3/2000	MLPL	850	20215500	-0.05555556
4/5/2000	MLPL	775	18325000	-0.08823529
4/7/2000	MLPL	800	8856500	0.032258065
4/10/2000	MLPL	750	2341000	-0.0625
4/11/2000	MLPL	775	5630000	0.033333333
4/12/2000	MLPL	775	694500	0
4/13/2000	MLPL	750	7011000	-0.03225806
4/14/2000	MLPL	700	17790500	-0.06666667
4/17/2000	MLPL	600	41774500	-0.14285714
4/18/2000	MLPL	625	48947000	0.041666667
4/19/2000	MLPL	675	92763500	0.08
4/20/2000	MLPL	650	28198000	-0.03703704
4/24/2000	MLPL	675	7217500	0.038461538
4/25/2000	MLPL	625	32881000	-0.07407407
4/26/2000	MLPL	625	13113500	0
4/27/2000	MLPL	650	1764500	0.04
4/28/2000	MLPL	650	12868500	0
5/1/2000	MLPL	650	765000	0
5/2/2000	MLPL	650	16161000	0
5/3/2000	MLPL	650	3160000	0
5/4/2000	MLPL	650	407500	0
5/5/2000	MLPL	650	927000	0
5/8/2000	MLPL	675	6576000	0.038461538
5/9/2000	MLPL	650	6518000	-0.03703704
5/10/2000	MLPL	650	729000	0
5/11/2000	MLPL	625	6059500	-0.03846154
5/12/2000	MLPL	625	10291500	0
5/15/2000	MLPL	625	2849000	0
5/16/2000	MLPL	575	8012000	-0.08
5/17/2000	MLPL	625	7583000	0.086956522
5/19/2000	MLPL	625	4684000	0
5/22/2000	MLPL	600	3325500	-0.04
5/23/2000	MLPL	600	4402500	0
5/24/2000	MLPL	550	7187000	-0.08333333
5/25/2000	MLPL	550	6766000	0
5/26/2000	MLPL	500	16823000	-0.09090909
5/29/2000	MLPL	450	9047000	-0.1
5/30/2000	MLPL	475	17344500	0.055555556
5/31/2000	MLPL	450	16624500	-0.05263158

6/2/2000	MLPL	425	4465500	-0.05555556
6/5/2000	MLPL	450	1486000	0.058823529
6/6/2000	MLPL	450	6913500	0
6/7/2000	MLPL	450	13845500	0
6/8/2000	MLPL	475	18702500	0.055555556
6/9/2000	MLPL	475	9842000	0
6/12/2000	MLPL	450	1741500	-0.05263158
6/13/2000	MLPL	425	8277500	-0.05555556
6/14/2000	MLPL	450	5363500	0.058823529
6/16/2000	MLPL	500	28520000	0.111111111
6/19/2000	MLPL	625	106624500	0.25
6/20/2000	MLPL	650	138478000	0.04
6/21/2000	MLPL	625	27086500	-0.03846154
6/22/2000	MLPL	600	8444500	-0.04
6/23/2000	MLPL	600	5109000	0
6/26/2000	MLPL	600	59882500	0
6/27/2000	MLPL	600	23615500	0
6/28/2000	MLPL	650	9457500	0.083333333
6/29/2000	MLPL	650	3831500	0
6/30/2000	MLPL	625	3686000	-0.03846154
7/3/2000	MLPL	560	17774000	-0.104
7/4/2000	MLPL	610	26351500	0.089285714
7/5/2000	MLPL	585	34062500	-0.04098361
7/6/2000	MLPL	570	16005500	-0.02564103
7/7/2000	MLPL	560	7760500	-0.01754386
7/10/2000	MLPL	545	27608000	-0.02678571
7/11/2000	MLPL	715	44047000	0.311926606
7/12/2000	MLPL	715	50149500	0
7/13/2000	MLPL	590	55196500	-0.17482517
7/14/2000	MLPL	580	32374500	-0.01694915
7/17/2000	MLPL	575	9079500	-0.00862069
7/18/2000	MLPL	575	11901500	0
7/19/2000	MLPL	590	18303000	0.026086957
7/20/2000	MLPL	580	16832000	-0.01694915
7/21/2000	MLPL	565	7905500	-0.02586207
7/24/2000	MLPL	565	7176000	0
7/25/2000	MLPL	555	4407500	-0.01769912
7/26/2000	MLPL	540	3796500	-0.02702703
7/27/2000	MLPL	535	10627000	-0.00925926
7/28/2000	MLPL	535	11062000	0
7/31/2000	MLPL	520	15811500	-0.02803738
8/1/2000	MLPL	510	29036500	-0.01923077
8/2/2000	MLPL	505	13685500	-0.00980392
8/3/2000	MLPL	505	19214000	0
8/4/2000	MLPL	505	10121000	0
8/7/2000	MLPL	505	9353500	0
8/8/2000	MLPL	490	14297000	-0.02970297
8/9/2000	MLPL	475	10196500	-0.03061224
8/10/2000	MLPL	520	67186500	0.094736842
8/11/2000	MLPL	530	37002500	0.019230769

8/14/2000	MLPL	520	25838500	-0.01886792
8/15/2000	MLPL	520	10798500	0
8/16/2000	MLPL	510	10527000	-0.01923077
8/18/2000	MLPL	505	2533000	-0.00980392
8/21/2000	MLPL	515	8692500	0.01980198
8/22/2000	MLPL	525	8878000	0.019417476
8/23/2000	MLPL	525	6408000	0
8/24/2000	MLPL	495	28635500	-0.05714286
8/25/2000	MLPL	510	7546000	0.03030303
8/28/2000	MLPL	500	6259500	-0.01960784
8/29/2000	MLPL	480	12421000	-0.04
8/30/2000	MLPL	480	13259000	0
8/31/2000	MLPL	480	7906000	0
9/1/2000	MLPL	485	6839500	0.010416667
9/4/2000	MLPL	490	5934000	0.010309278
9/5/2000	MLPL	490	1480000	0
9/6/2000	MLPL	480	5075500	-0.02040816
9/7/2000	MLPL	470	5716500	-0.02083333
9/8/2000	MLPL	460	3614000	-0.0212766
9/11/2000	MLPL	445	6275500	-0.0326087
9/12/2000	MLPL	425	6764500	-0.04494382
9/13/2000	MLPL	415	7482500	-0.02352941
9/18/2000	MLPL	375	13454000	-0.09638554
9/19/2000	MLPL	410	25676500	0.093333333
9/20/2000	MLPL	395	9382500	-0.03658537
9/21/2000	MLPL	385	3931500	-0.02531646
9/22/2000	MLPL	375	6967500	-0.02597403
9/25/2000	MLPL	375	6891000	0
9/26/2000	MLPL	375	3419500	0
9/27/2000	MLPL	375	1863000	0
9/28/2000	MLPL	380	8831000	0.013333333
9/29/2000	MLPL	390	12261000	0.026315789
10/2/2000	MLPL	400	12485000	0.025641026
10/3/2000	MLPL	400	15940000	0
10/4/2000	MLPL	390	6634000	-0.025
10/5/2000	MLPL	395	17480000	0.012820513
10/6/2000	MLPL	395	2227000	0
10/9/2000	MLPL	385	2856000	-0.02531646
10/10/2000	MLPL	390	4076000	0.012987013
10/11/2000	MLPL	385	5987500	-0.01282051
10/12/2000	MLPL	380	6563500	-0.01298701
10/13/2000	MLPL	380	9654500	0
10/16/2000	MLPL	385	5882000	0.013157895
10/17/2000	MLPL	460	127230000	0.194805195
10/18/2000	MLPL	460	94211500	0
10/19/2000	MLPL	460	43476000	0
10/20/2000	MLPL	440	46271500	-0.04347826
10/23/2000	MLPL	395	22626000	-0.10227273
10/24/2000	MLPL	400	14979000	0.012658228
10/26/2000	MLPL	385	6594500	-0.0375

10/27/2000	MLPL	385	6271500	0
10/30/2000	MLPL	375	5624500	-0.02597403
10/31/2000	MLPL	370	12007500	-0.01333333
11/1/2000	MLPL	380	13405500	0.027027027
11/2/2000	MLPL	385	5703500	0.013157895
11/3/2000	MLPL	380	6116000	-0.01298701
11/6/2000	MLPL	390	5615500	0.026315789
11/7/2000	MLPL	385	3908500	-0.01282051
11/8/2000	MLPL	385	9767500	0
11/9/2000	MLPL	390	6725000	0.012987013
11/10/2000	MLPL	390	4569000	0
11/13/2000	MLPL	385	3100500	-0.01282051
11/14/2000	MLPL	375	7315000	-0.02597403
11/15/2000	MLPL	380	4461000	0.013333333
11/16/2000	MLPL	385	6621000	0.013157895
11/17/2000	MLPL	390	8814000	0.012987013
11/20/2000	MLPL	405	28475500	0.038461538
11/21/2000	MLPL	405	12467000	0
11/22/2000	MLPL	410	26288000	0.012345679
11/23/2000	MLPL	410	9494000	0
11/24/2000	MLPL	410	5429500	0
11/27/2000	MLPL	410	4584000	0
11/28/2000	MLPL	410	3271000	0
11/29/2000	MLPL	400	1247000	-0.02439024
11/30/2000	MLPL	405	5429000	0.0125
12/1/2000	MLPL	405	1750000	0
12/4/2000	MLPL	400	8327500	-0.01234568
12/5/2000	MLPL	410	19451500	0.025
12/6/2000	MLPL	415	11063500	0.012195122
12/7/2000	MLPL	405	9713500	-0.02409639
12/8/2000	MLPL	400	1632000	-0.01234568
12/11/2000	MLPL	385	6593000	-0.0375
12/12/2000	MLPL	385	3492000	0
12/13/2000	MLPL	385	19185000	0
12/14/2000	MLPL	375	10868500	-0.02597403
12/15/2000	MLPL	360	6893000	-0.04
12/18/2000	MLPL	360	3292000	0
12/19/2000	MLPL	360	2632500	0
12/20/2000	MLPL	360	1795000	0
12/21/2000	MLPL	360	1101000	0
12/22/2000	MLPL	355	5751000	-0.01388889
1/2/2001	MLPL	340	1157000	-0.04225352
1/3/2001	MLPL	330	3261500	-0.02941176
1/4/2001	MLPL	335	4685000	0.015151515
1/5/2001	MLPL	380	90329000	0.134328358
1/8/2001	MLPL	375	18828500	-0.01315789
1/9/2001	MLPL	350	12500000	-0.06666667
1/10/2001	MLPL	350	4319000	0
1/11/2001	MLPL	335	6277000	-0.04285714
1/12/2001	MLPL	345	8526500	0.029850746

1/15/2001	MLPL	355	5464500	0.028985507
1/16/2001	MLPL	355	3820500	0
1/17/2001	MLPL	350	16717000	-0.01408451
1/18/2001	MLPL	350	3550500	0
1/19/2001	MLPL	350	3068500	0
1/22/2001	MLPL	350	4196500	0
1/23/2001	MLPL	350	1498000	0
1/24/2001	MLPL	350	829000	0
1/25/2001	MLPL	345	4918500	-0.01428571
1/26/2001	MLPL	355	9985000	0.028985507
1/29/2001	MLPL	350	1790500	-0.01408451
1/30/2001	MLPL	360	8198000	0.028571429
1/31/2001	MLPL	370	19463000	0.027777778
2/1/2001	MLPL	365	18568000	-0.01351351
2/2/2001	MLPL	390	49810500	0.068493151
2/5/2001	MLPL	375	43955500	-0.03846154
2/6/2001	MLPL	365	8578500	-0.02666667
2/7/2001	MLPL	360	4830000	-0.01369863
2/8/2001	MLPL	355	3875000	-0.01388889
2/9/2001	MLPL	345	4926500	-0.02816901
2/12/2001	MLPL	350	4399000	0.014492754
2/13/2001	MLPL	345	4167500	-0.01428571
2/14/2001	MLPL	335	16133500	-0.02898551
2/15/2001	MLPL	355	39500000	0.059701493
2/16/2001	MLPL	340	11531000	-0.04225352
2/19/2001	MLPL	345	5643000	0.014705882
2/20/2001	MLPL	350	12700500	0.014492754
2/21/2001	MLPL	345	3542500	-0.01428571
2/22/2001	MLPL	345	4038000	0
2/23/2001	MLPL	345	3138500	0
2/26/2001	MLPL	340	1329500	-0.01449275
2/27/2001	MLPL	340	4561000	0
2/28/2001	MLPL	335	4411000	-0.01470588
3/1/2001	MLPL	330	3705000	-0.01492537
3/2/2001	MLPL	335	1962500	0.015151515
3/6/2001	MLPL	330	2238500	-0.01492537
3/7/2001	MLPL	335	7539500	0.015151515
3/8/2001	MLPL	335	7713500	0
3/9/2001	MLPL	325	9348500	-0.02985075
3/12/2001	MLPL	290	15540000	-0.10769231
3/13/2001	MLPL	280	6978500	-0.03448276
3/14/2001	MLPL	275	9568500	-0.01785714
3/15/2001	MLPL	275	6420500	0
3/16/2001	MLPL	265	4865500	-0.03636364
3/19/2001	MLPL	230	9790500	-0.13207547
3/20/2001	MLPL	210	10779000	-0.08695652
3/21/2001	MLPL	210	32491000	0
3/22/2001	MLPL	235	135808000	0.119047619
3/23/2001	MLPL	260	66129000	0.106382979
3/27/2001	MLPL	245	20893000	-0.05769231

3/28/2001	MLPL	250	22849500	0.020408163
3/29/2001	MLPL	250	12685000	0
3/30/2001	MLPL	250	5994500	0
4/2/2001	MLPL	240	3655000	-0.04
4/3/2001	MLPL	230	7486500	-0.04166667
4/4/2001	MLPL	220	13896500	-0.04347826
4/5/2001	MLPL	230	29532000	0.045454545
4/6/2001	MLPL	230	9251500	0
4/9/2001	MLPL	235	8474000	0.02173913
4/10/2001	MLPL	235	4028000	0
4/11/2001	MLPL	235	8636000	0
4/12/2001	MLPL	235	2757000	0
4/16/2001	MLPL	235	2721500	0
4/17/2001	MLPL	225	2050000	-0.04255319
4/18/2001	MLPL	220	4098000	-0.02222222
4/19/2001	MLPL	195	12970000	-0.11363636
4/20/2001	MLPL	170	17055500	-0.12820513
4/23/2001	MLPL	190	16483500	0.117647059
4/24/2001	MLPL	190	12929500	0
4/25/2001	MLPL	200	29611500	0.052631579
4/26/2001	MLPL	195	5162000	-0.025
4/27/2001	MLPL	205	22546500	0.051282051
4/30/2001	MLPL	215	13899500	0.048780488
5/1/2001	MLPL	215	57934500	0
5/2/2001	MLPL	220	20165500	0.023255814
5/3/2001	MLPL	230	20915500	0.045454545
5/4/2001	MLPL	235	16350500	0.02173913
5/8/2001	MLPL	225	13936000	-0.04255319
5/9/2001	MLPL	225	7971500	0
5/10/2001	MLPL	220	5219000	-0.02222222
5/11/2001	MLPL	230	26189500	0.045454545
5/14/2001	MLPL	235	36805000	0.02173913
5/15/2001	MLPL	240	15029500	0.021276596
5/16/2001	MLPL	240	25866000	0
5/17/2001	MLPL	240	13632000	0
5/18/2001	MLPL	240	4397500	0
5/21/2001	MLPL	235	4538000	-0.02083333
5/22/2001	MLPL	235	4764500	0
5/23/2001	MLPL	235	1380500	0
5/25/2001	MLPL	240	7292000	0.021276596
5/28/2001	MLPL	240	4569000	0
5/29/2001	MLPL	260	46395000	0.083333333
5/30/2001	MLPL	260	69727000	0
5/31/2001	MLPL	285	88614000	0.096153846
6/1/2001	MLPL	250	56585000	-0.12280702
6/5/2001	MLPL	275	44727500	0.1
6/6/2001	MLPL	270	41386000	-0.01818182
6/7/2001	MLPL	255	12603000	-0.05555556
6/8/2001	MLPL	260	23525500	0.019607843
6/11/2001	MLPL	265	14487000	0.019230769

6/12/2001	MLPL	280	48798500	0.056603774
6/13/2001	MLPL	280	20588000	0
6/14/2001	MLPL	265	10565500	-0.05357143
6/15/2001	MLPL	265	2651500	0
6/18/2001	MLPL	275	6228000	0.037735849
6/19/2001	MLPL	270	10163500	-0.01818182
6/20/2001	MLPL	280	5136000	0.037037037
6/21/2001	MLPL	280	33597500	0
6/22/2001	MLPL	290	14396000	0.035714286
6/25/2001	MLPL	290	16572000	0
6/26/2001	MLPL	340	117242500	0.172413793
6/27/2001	MLPL	325	155789000	-0.04411765
6/28/2001	MLPL	310	50547000	-0.04615385
6/29/2001	MLPL	320	25773000	0.032258065
7/2/2001	MLPL	320	6164000	0
7/3/2001	MLPL	330	46091000	0.03125
7/4/2001	MLPL	330	6767500	0
7/5/2001	MLPL	325	4746000	-0.01515152
7/6/2001	MLPL	335	10775000	0.030769231
7/9/2001	MLPL	345	52204000	0.029850746
7/10/2001	MLPL	350	54051500	0.014492754
7/11/2001	MLPL	365	66796500	0.042857143
7/12/2001	MLPL	380	147918000	0.04109589
7/13/2001	MLPL	365	53531500	-0.03947368
7/16/2001	MLPL	360	18354000	-0.01369863
7/17/2001	MLPL	370	30283000	0.027777778
7/18/2001	MLPL	375	15026500	0.013513514
7/19/2001	MLPL	385	69551500	0.026666667
7/20/2001	MLPL	380	29442000	-0.01298701
7/23/2001	MLPL	400	192595500	0.052631579
7/24/2001	MLPL	385	86743500	-0.0375
7/25/2001	MLPL	375	54366000	-0.02597403
7/26/2001	MLPL	375	32044500	0
7/27/2001	MLPL	375	12512500	0
7/30/2001	MLPL	380	12217500	0.013333333
7/31/2001	MLPL	375	8583000	-0.01315789
8/1/2001	MLPL	375	3513000	0
8/2/2001	MLPL	360	13155000	-0.04
8/3/2001	MLPL	350	21142000	-0.02777778
8/6/2001	MLPL	365	21735500	0.042857143
8/7/2001	MLPL	365	12184500	0
8/8/2001	MLPL	380	9618500	0.04109589
8/9/2001	MLPL	355	44081000	-0.06578947
8/10/2001	MLPL	370	8936500	0.042253521
8/13/2001	MLPL	400	68357000	0.081081081
8/14/2001	MLPL	380	51995000	-0.05
8/15/2001	MLPL	375	18156000	-0.01315789
8/16/2001	MLPL	365	16725500	-0.026666667
8/20/2001	MLPL	380	23965000	0.04109589
8/21/2001	MLPL	375	5940500	-0.01315789

8/22/2001	MLPL	375	5814500	0
8/23/2001	MLPL	370	1260000	-0.01333333
8/24/2001	MLPL	370	5594000	0
8/27/2001	MLPL	370	8682000	0
8/28/2001	MLPL	365	14048000	-0.01351351
8/29/2001	MLPL	355	10989500	-0.02739726
8/30/2001	MLPL	355	8463000	0
8/31/2001	MLPL	355	9786500	0
9/3/2001	MLPL	350	8544500	-0.01408451
9/4/2001	MLPL	360	17609000	0.028571429
9/5/2001	MLPL	350	9421000	-0.02777778
9/6/2001	MLPL	370	51843000	0.057142857
9/7/2001	MLPL	360	20017500	-0.02702703
9/10/2001	MLPL	360	9532000	0
9/11/2001	MLPL	355	2724000	-0.01388889
9/12/2001	MLPL	330	38780000	-0.07042254
9/13/2001	MLPL	325	18162500	-0.01515152
9/14/2001	MLPL	310	32394500	-0.04615385
9/17/2001	MLPL	275	34527500	-0.11290323
9/18/2001	MLPL	285	27874500	0.036363636
9/19/2001	MLPL	310	47515500	0.087719298
9/20/2001	MLPL	305	29108000	-0.01612903
9/21/2001	MLPL	290	34250000	-0.04918033
9/24/2001	MLPL	290	27028500	0
9/25/2001	MLPL	290	31965500	0
9/26/2001	MLPL	280	24530000	-0.03448276
9/27/2001	MLPL	275	29134500	-0.01785714
9/28/2001	MLPL	275	16624500	0
10/1/2001	MLPL	275	11897500	0
10/2/2001	MLPL	270	10299000	-0.01818182
10/3/2001	MLPL	260	28831500	-0.03703704
10/4/2001	MLPL	275	30969000	0.057692308
10/5/2001	MLPL	275	17877000	0
10/8/2001	MLPL	260	30938500	-0.05454545
10/9/2001	MLPL	255	24645500	-0.01923077
10/10/2001	MLPL	260	5031500	0.019607843
10/11/2001	MLPL	255	15393000	-0.01923077
10/12/2001	MLPL	270	26737500	0.058823529
10/16/2001	MLPL	260	5028500	-0.03703704
10/17/2001	MLPL	270	2364000	0.038461538
10/18/2001	MLPL	275	34007000	0.018518519
10/19/2001	MLPL	275	9769500	0
10/22/2001	MLPL	270	7502500	-0.01818182
10/23/2001	MLPL	280	34549500	0.037037037
10/24/2001	MLPL	280	9460500	0
10/25/2001	MLPL	280	2517500	0
10/26/2001	MLPL	275	3782000	-0.01785714
10/29/2001	MLPL	275	2013000	0
10/30/2001	MLPL	270	6310500	-0.01818182
10/31/2001	MLPL	275	14497500	0.018518519

11/1/2001	MLPL	275	4628500	0
11/2/2001	MLPL	270	10673000	-0.01818182
11/5/2001	MLPL	270	3992500	0
11/6/2001	MLPL	270	7971000	0
11/7/2001	MLPL	270	3661500	0
11/8/2001	MLPL	265	4048500	-0.01851852
11/9/2001	MLPL	260	4950000	-0.01886792
11/12/2001	MLPL	260	3169000	0
11/13/2001	MLPL	265	2650000	0.019230769
11/14/2001	MLPL	270	14564500	0.018867925
11/15/2001	MLPL	275	28363000	0.018518519
11/16/2001	MLPL	270	2777500	-0.01818182
11/19/2001	MLPL	270	7778000	0
11/20/2001	MLPL	270	6557500	0
11/21/2001	MLPL	270	7464000	0
11/22/2001	MLPL	265	4338000	-0.01851852
11/23/2001	MLPL	270	5713500	0.018867925
11/26/2001	MLPL	270	3748500	0
11/27/2001	MLPL	270	3313000	0
11/28/2001	MLPL	270	8633500	0
11/29/2001	MLPL	270	8293000	0
11/30/2001	MLPL	265	6921000	-0.01851852
12/3/2001	MLPL	270	3980500	0.018867925
12/4/2001	MLPL	270	5845000	0
12/5/2001	MLPL	265	2784500	-0.01851852
12/6/2001	MLPL	260	1251000	-0.01886792
12/7/2001	MLPL	260	1610000	0
12/10/2001	MLPL	260	756500	0
12/11/2001	MLPL	260	1021500	0
12/12/2001	MLPL	255	351000	-0.01923077
12/13/2001	MLPL	250	1810000	-0.01960784
12/19/2001	MLPL	250	2322500	0
12/20/2001	MLPL	245	4470000	-0.02
12/21/2001	MLPL	245	4712500	0
12/26/2001	MLPL	245	1309500	0
12/27/2001	MLPL	250	554000	0.020408163
12/28/2001	MLPL	245	5346000	-0.02
1/2/2002	MLPL	240	2760500	-0.02040816
1/3/2002	MLPL	235	1791500	-0.02083333
1/4/2002	MLPL	245	6395000	0.042553191
1/7/2002	MLPL	250	5699000	0.020408163
1/8/2002	MLPL	245	3595000	-0.02
1/9/2002	MLPL	245	8505000	0
1/10/2002	MLPL	260	19403500	0.06122449
1/11/2002	MLPL	255	44116000	-0.01923077
1/14/2002	MLPL	260	9531000	0.019607843
1/15/2002	MLPL	265	21819500	0.019230769
1/16/2002	MLPL	270	58372500	0.018867925
1/17/2002	MLPL	265	12240500	-0.01851852
1/18/2002	MLPL	265	1995000	0

1/21/2002	MLPL	260	3325500	-0.01886792
1/22/2002	MLPL	260	7471500	0
1/23/2002	MLPL	265	4022500	0.019230769
1/24/2002	MLPL	270	71861500	0.018867925
1/25/2002	MLPL	265	11384000	-0.01851852
1/28/2002	MLPL	265	13271500	0
1/29/2002	MLPL	270	9592500	0.018867925
1/30/2002	MLPL	265	1415000	-0.01851852
1/31/2002	MLPL	265	1430500	0
2/1/2002	MLPL	280	53994000	0.056603774
2/4/2002	MLPL	275	11574000	-0.01785714
2/5/2002	MLPL	280	17841000	0.018181818
2/6/2002	MLPL	290	56316500	0.035714286
2/7/2002	MLPL	280	32624500	-0.03448276
2/8/2002	MLPL	280	25739000	0
2/11/2002	MLPL	280	6261500	0
2/13/2002	MLPL	280	1620500	0
2/14/2002	MLPL	280	11118500	0
2/15/2002	MLPL	290	37786000	0.035714286
2/18/2002	MLPL	295	43072500	0.017241379
2/19/2002	MLPL	295	66728500	0
2/20/2002	MLPL	320	123532500	0.084745763
2/21/2002	MLPL	315	43933500	-0.015625
2/25/2002	MLPL	300	45397000	-0.04761905
2/26/2002	MLPL	300	11691000	0
2/27/2002	MLPL	305	14959500	0.016666667
2/28/2002	MLPL	300	14690000	-0.01639344
3/1/2002	MLPL	300	6844500	0
3/4/2002	MLPL	300	4692500	0
3/5/2002	MLPL	305	11969500	0.016666667
3/6/2002	MLPL	310	10874000	0.016393443
3/7/2002	MLPL	310	19286000	0
3/8/2002	MLPL	300	8076000	-0.03225806
3/11/2002	MLPL	300	27595500	0
3/12/2002	MLPL	290	30958500	-0.03333333
3/13/2002	MLPL	295	16573000	0.017241379
3/14/2002	MLPL	285	13198500	-0.03389831
3/18/2002	MLPL	285	7477500	0
3/19/2002	MLPL	290	11906000	0.01754386
3/20/2002	MLPL	290	4584500	0
3/21/2002	MLPL	300	60481500	0.034482759
3/22/2002	MLPL	310	17933000	0.033333333
3/25/2002	MLPL	305	13834500	-0.01612903
3/26/2002	MLPL	310	12609000	0.016393443
3/27/2002	MLPL	300	9312500	-0.03225806
3/28/2002	MLPL	300	8983000	0
4/1/2002	MLPL	305	5570000	0.016666667
4/2/2002	MLPL	305	17003000	0
4/3/2002	MLPL	305	4368500	0
4/4/2002	MLPL	310	19012500	0.016393443

4/5/2002	MLPL	315	21463500	0.016129032
4/8/2002	MLPL	315	30191500	0
4/9/2002	MLPL	310	26833500	-0.01587302
4/10/2002	MLPL	315	29600000	0.016129032
4/11/2002	MLPL	370	221773500	0.174603175
4/12/2002	MLPL	390	77522500	0.054054054
4/15/2002	MLPL	395	114218000	0.012820513
4/16/2002	MLPL	370	88005000	-0.06329114
4/17/2002	MLPL	350	79856500	-0.05405405
4/18/2002	MLPL	340	30473500	-0.02857143
4/19/2002	MLPL	355	24221000	0.044117647
4/22/2002	MLPL	345	31744000	-0.02816901
4/23/2002	MLPL	345	12684000	0
4/24/2002	MLPL	355	15488000	0.028985507
4/25/2002	MLPL	350	21098500	-0.01408451
4/26/2002	MLPL	350	8571500	0
4/29/2002	MLPL	340	14270000	-0.02857143
4/30/2002	MLPL	345	15110000	0.014705882
5/1/2002	MLPL	345	6001000	0
5/2/2002	MLPL	345	4396500	0
5/3/2002	MLPL	345	5450000	0
5/6/2002	MLPL	345	11146500	0
5/7/2002	MLPL	340	4370500	-0.01449275
5/8/2002	MLPL	345	10366500	0.014705882
5/10/2002	MLPL	350	7995500	0.014492754
5/13/2002	MLPL	340	5324000	-0.02857143
5/14/2002	MLPL	340	4219000	0
5/15/2002	MLPL	340	2745000	0
5/16/2002	MLPL	335	7559000	-0.01470588
5/17/2002	MLPL	335	8193500	0
5/20/2002	MLPL	325	3344000	-0.02985075
5/21/2002	MLPL	325	3243500	0
5/22/2002	MLPL	305	13508500	-0.06153846
5/23/2002	MLPL	295	15473500	-0.03278689
5/24/2002	MLPL	290	31489000	-0.01694915
5/27/2002	MLPL	295	7728000	0.017241379
5/28/2002	MLPL	295	1500000	0
5/29/2002	MLPL	300	2251000	0.016949153
5/30/2002	MLPL	305	5293500	0.016666667
5/31/2002	MLPL	315	18001500	0.032786885
6/3/2002	MLPL	300	3011500	-0.04761905
6/4/2002	MLPL	300	1594000	0
6/5/2002	MLPL	300	7058500	0
6/6/2002	MLPL	300	2888500	0
6/7/2002	MLPL	300	1221500	0
6/10/2002	MLPL	300	1831000	0
6/11/2002	MLPL	305	1795500	0.016666667
6/12/2002	MLPL	300	7999000	-0.01639344
6/13/2002	MLPL	325	17108500	0.083333333
6/14/2002	MLPL	320	12855000	-0.01538462

6/17/2002	MLPL	325	3695000	0.015625
6/18/2002	MLPL	330	17706500	0.015384615
6/19/2002	MLPL	320	7220500	-0.03030303
6/20/2002	MLPL	320	5980500	0
6/21/2002	MLPL	320	4182500	0
6/24/2002	MLPL	320	4069500	0
6/25/2002	MLPL	320	8419000	0
6/26/2002	MLPL	300	12461000	-0.0625
6/27/2002	MLPL	305	8582500	0.016666667
6/28/2002	MLPL	300	3025000	-0.01639344
7/1/2002	MLPL	290	4722000	-0.03333333
7/2/2002	MLPL	280	22198500	-0.03448276
7/3/2002	MLPL	285	7528000	0.017857143
7/4/2002	MLPL	290	9802000	0.01754386
7/5/2002	MLPL	290	4003000	0
7/8/2002	MLPL	280	10865000	-0.03448276
7/9/2002	MLPL	280	5853500	0
7/10/2002	MLPL	275	2375500	-0.01785714
7/11/2002	MLPL	275	8964000	0
7/12/2002	MLPL	280	7533000	0.018181818
7/15/2002	MLPL	275	4030500	-0.01785714
7/16/2002	MLPL	265	3838000	-0.03636364
7/17/2002	MLPL	275	3359000	0.037735849
7/18/2002	MLPL	275	4763000	0
7/19/2002	MLPL	270	1894500	-0.01818182
7/22/2002	MLPL	260	2732000	-0.03703704
7/23/2002	MLPL	265	5427500	0.019230769
7/24/2002	MLPL	240	9099500	-0.09433962
7/25/2002	MLPL	245	4409500	0.020833333
7/26/2002	MLPL	230	3169500	-0.06122449
7/29/2002	MLPL	245	2431000	0.065217391
7/30/2002	MLPL	260	10720500	0.06122449
7/31/2002	MLPL	255	851000	-0.01923077
8/1/2002	MLPL	250	2026000	-0.01960784
8/2/2002	MLPL	245	1311000	-0.02
8/5/2002	MLPL	240	7016000	-0.02040816
8/6/2002	MLPL	235	2961000	-0.02083333
8/7/2002	MLPL	245	1538000	0.042553191
8/8/2002	MLPL	250	5383500	0.020408163
8/9/2002	MLPL	245	466500	-0.02
8/12/2002	MLPL	235	9270000	-0.04081633
8/13/2002	MLPL	235	1102500	0
8/14/2002	MLPL	235	910000	0
8/15/2002	MLPL	240	5015500	0.021276596
8/16/2002	MLPL	230	4179000	-0.04166667
8/19/2002	MLPL	230	2368000	0
8/20/2002	MLPL	240	3121500	0.043478261
8/21/2002	MLPL	250	12027000	0.041666667
8/22/2002	MLPL	240	5932500	-0.04
8/23/2002	MLPL	245	1847000	0.020833333

8/26/2002	MLPL	235	956000	-0.04081633
8/27/2002	MLPL	235	822000	0
8/28/2002	MLPL	230	3382000	-0.0212766
8/29/2002	MLPL	230	1151000	0
8/30/2002	MLPL	235	86500	0.02173913
9/2/2002	MLPL	230	76500	-0.0212766
9/3/2002	MLPL	225	1946000	-0.02173913
9/4/2002	MLPL	215	1936500	-0.04444444
9/5/2002	MLPL	240	6457500	0.11627907
9/6/2002	MLPL	230	6271500	-0.04166667
9/9/2002	MLPL	230	3316000	0
9/10/2002	MLPL	230	2698000	0
9/11/2002	MLPL	225	1852500	-0.02173913
9/12/2002	MLPL	230	1439000	0.02222222
9/13/2002	MLPL	220	1148500	-0.04347826
9/16/2002	MLPL	220	915000	0
9/17/2002	MLPL	225	4714500	0.02272727
9/18/2002	MLPL	215	691000	-0.04444444
9/19/2002	MLPL	210	4041000	-0.02325581
9/20/2002	MLPL	200	3544500	-0.04761905
9/23/2002	MLPL	210	780500	0.05
9/24/2002	MLPL	205	765500	-0.02380952
9/25/2002	MLPL	195	3381500	-0.04878049
9/26/2002	MLPL	205	1702500	0.05128205
9/27/2002	MLPL	200	892500	-0.02439024
9/30/2002	MLPL	195	442500	-0.025
10/1/2002	MLPL	200	1459000	0.025641026
10/2/2002	MLPL	195	923000	-0.025
10/3/2002	MLPL	195	140000	0
10/7/2002	MLPL	185	1368000	-0.05128205
10/8/2002	MLPL	190	807500	0.027027027
10/9/2002	MLPL	180	1342500	-0.05263158
10/10/2002	MLPL	175	811500	-0.02777778
10/11/2002	MLPL	165	853000	-0.05714286
10/14/2002	MLPL	125	4919500	-0.24242424
10/15/2002	MLPL	145	10501500	0.16
10/16/2002	MLPL	145	7842000	0
10/17/2002	MLPL	145	1216000	0
10/18/2002	MLPL	150	14909000	0.034482759
10/21/2002	MLPL	165	5820500	0.1
10/22/2002	MLPL	160	4098500	-0.03030303
10/23/2002	MLPL	155	3669500	-0.03125
10/24/2002	MLPL	150	756500	-0.03225806
10/25/2002	MLPL	155	580500	0.03333333
10/28/2002	MLPL	160	8844500	0.032258065
10/29/2002	MLPL	155	5301500	-0.03125
10/30/2002	MLPL	155	1005500	0
10/31/2002	MLPL	165	7105500	0.064516129
11/1/2002	MLPL	165	4790000	0
11/4/2002	MLPL	180	10330000	0.090909091

11/5/2002	MLPL	180	21421500	0
11/6/2002	MLPL	175	3325000	-0.02777778
11/7/2002	MLPL	170	926500	-0.02857143
11/8/2002	MLPL	170	1798500	0
11/11/2002	MLPL	165	1697500	-0.02941176
11/12/2002	MLPL	170	1886500	0.03030303
11/13/2002	MLPL	170	998000	0
11/14/2002	MLPL	170	187000	0
11/15/2002	MLPL	165	3427000	-0.02941176
11/18/2002	MLPL	165	1458000	0
11/19/2002	MLPL	165	1023000	0
11/20/2002	MLPL	165	1805500	0
11/21/2002	MLPL	165	702500	0
11/22/2002	MLPL	175	2478500	0.060606061
11/25/2002	MLPL	170	1264000	-0.02857143
11/26/2002	MLPL	170	493000	0
11/27/2002	MLPL	170	214000	0
11/28/2002	MLPL	170	1688000	0
11/29/2002	MLPL	165	2887500	-0.02941176
12/2/2002	MLPL	165	1986000	0
12/3/2002	MLPL	170	2424500	0.03030303
12/4/2002	MLPL	170	539500	0
12/11/2002	MLPL	165	2161500	-0.02941176
12/12/2002	MLPL	165	1249000	0
12/13/2002	MLPL	165	125000	0
12/16/2002	MLPL	165	4469500	0
12/17/2002	MLPL	170	7106000	0.03030303
12/18/2002	MLPL	170	1130500	0
12/19/2002	MLPL	180	13114000	0.058823529
12/20/2002	MLPL	180	7366500	0
12/23/2002	MLPL	180	1645500	0
12/27/2002	MLPL	170	1838500	-0.05555556
1/2/2003	MLPL	160	1696500	-0.05882353
1/3/2003	MLPL	165	613500	0.03125
1/6/2003	MLPL	160	1514000	-0.03030303
1/7/2003	MLPL	160	220000	0
1/8/2003	MLPL	150	2172500	-0.0625
1/9/2003	MLPL	150	1928000	0
1/10/2003	MLPL	150	1861000	0
1/13/2003	MLPL	155	971000	0.033333333
1/14/2003	MLPL	160	2263000	0.032258065
1/15/2003	MLPL	155	816500	-0.03125
1/16/2003	MLPL	155	1624500	0
1/17/2003	MLPL	155	475000	0
1/20/2003	MLPL	150	336500	-0.03225806
1/21/2003	MLPL	150	82500	0
1/22/2003	MLPL	145	3153500	-0.03333333
1/23/2003	MLPL	150	1209500	0.034482759
1/24/2003	MLPL	145	561000	-0.03333333
1/27/2003	MLPL	135	1811500	-0.06896552

1/28/2003	MLPL	135	1006500	0
1/29/2003	MLPL	130	1206000	-0.03703704
1/30/2003	MLPL	135	830000	0.038461538
1/31/2003	MLPL	125	994000	-0.07407407
2/3/2003	MLPL	130	1489500	0.04
2/4/2003	MLPL	130	1013500	0
2/5/2003	MLPL	125	870000	-0.03846154
2/6/2003	MLPL	125	616500	0
2/7/2003	MLPL	125	1739000	0
2/9/2003	MLPL	205	1637500	0.64
2/10/2003	MLPL	130	4914000	-0.36585366
2/11/2003	MLPL	130	1982000	0
2/13/2003	MLPL	125	276500	-0.03846154
2/14/2003	MLPL	130	282000	0.04
2/17/2003	MLPL	130	1781500	0
2/18/2003	MLPL	130	838000	0
2/19/2003	MLPL	130	388500	0
2/20/2003	MLPL	130	281500	0
2/21/2003	MLPL	130	125000	0
2/24/2003	MLPL	130	1544500	0
2/25/2003	MLPL	125	397000	-0.03846154
2/26/2003	MLPL	125	22000	0
2/27/2003	MLPL	125	3338500	0
2/28/2003	MLPL	135	10566500	0.08
3/4/2003	MLPL	135	1217500	0
3/5/2003	MLPL	130	645000	-0.03703704
3/6/2003	MLPL	135	828000	0.038461538
3/7/2003	MLPL	135	1913000	0
3/9/2003	MLPL	205	23600000	0.518518519
3/10/2003	MLPL	130	247000	-0.36585366
3/11/2003	MLPL	125	778500	-0.03846154
3/12/2003	MLPL	130	2924000	0.04
3/13/2003	MLPL	125	1646000	-0.03846154
3/14/2003	MLPL	125	2087000	0
3/17/2003	MLPL	125	564000	0
3/18/2003	MLPL	125	2196000	0
3/19/2003	MLPL	125	256500	0
3/20/2003	MLPL	130	4716000	0.04
3/21/2003	MLPL	125	1321000	-0.03846154
3/24/2003	MLPL	130	333000	0.04
3/25/2003	MLPL	125	46000	-0.03846154
3/26/2003	MLPL	125	876000	0
3/27/2003	MLPL	125	320500	0
3/28/2003	MLPL	125	670500	0
3/31/2003	MLPL	125	448500	0
4/1/2003	MLPL	120	315000	-0.04
4/3/2003	MLPL	120	141000	0
4/4/2003	MLPL	130	2630500	0.083333333
4/7/2003	MLPL	135	18123500	0.038461538
4/8/2003	MLPL	140	19176000	0.037037037

4/9/2003	MLPL	150	9285500	0.071428571
4/10/2003	MLPL	145	3978500	-0.033333333
4/11/2003	MLPL	150	10875000	0.034482759
4/14/2003	MLPL	145	5226000	-0.033333333
4/15/2003	MLPL	145	3292500	0
4/16/2003	MLPL	160	10768500	0.103448276
4/17/2003	MLPL	195	63257500	0.21875
4/21/2003	MLPL	200	27672000	0.025641026
4/22/2003	MLPL	190	12786000	-0.05
4/23/2003	MLPL	195	9669500	0.026315789
4/24/2003	MLPL	205	16907500	0.051282051
4/25/2003	MLPL	190	18682000	-0.07317073
4/28/2003	MLPL	180	9213000	-0.05263158
4/29/2003	MLPL	195	18444500	0.083333333
4/30/2003	MLPL	200	46046000	0.025641026
5/1/2003	MLPL	200	11271000	0
5/2/2003	MLPL	205	9887500	0.025
5/5/2003	MLPL	205	23947500	0
5/6/2003	MLPL	215	30055000	0.048780488
5/7/2003	MLPL	210	18103000	-0.02325581
5/8/2003	MLPL	205	8324000	-0.02380952
5/9/2003	MLPL	205	5056000	0
5/12/2003	MLPL	195	2964500	-0.04878049
5/13/2003	MLPL	200	7787500	0.025641026
5/14/2003	MLPL	200	4940000	0
5/19/2003	MLPL	185	5205500	-0.075
5/20/2003	MLPL	190	7669500	0.027027027
5/21/2003	MLPL	190	3720000	0
5/22/2003	MLPL	190	2773500	0
5/23/2003	MLPL	200	6257000	0.052631579
5/26/2003	MLPL	200	13482500	0
5/27/2003	MLPL	200	5452000	0
5/28/2003	MLPL	215	82987000	0.075
5/29/2003	MLPL	225	65567500	0.046511628
6/2/2003	MLPL	230	13976500	0.022222222
6/3/2003	MLPL	225	17101000	-0.02173913
6/4/2003	MLPL	240	28247500	0.066666667
6/5/2003	MLPL	240	43625500	0
6/6/2003	MLPL	245	7938000	0.020833333
6/9/2003	MLPL	260	62978500	0.06122449
6/10/2003	MLPL	255	15301000	-0.01923077
6/11/2003	MLPL	240	24344500	-0.05882353
6/12/2003	MLPL	230	22868000	-0.04166667
6/13/2003	MLPL	245	16076000	0.065217391
6/16/2003	MLPL	240	3582500	-0.02040816
6/17/2003	MLPL	230	15767500	-0.04166667
6/18/2003	MLPL	220	10201000	-0.04347826
6/19/2003	MLPL	230	5722500	0.045454545
6/20/2003	MLPL	225	1809500	-0.02173913
6/23/2003	MLPL	220	2450000	-0.02222222

6/24/2003	MLPL	210	9193500	-0.04545455
6/25/2003	MLPL	215	7583500	0.023809524
6/26/2003	MLPL	200	6618000	-0.06976744
6/27/2003	MLPL	210	2146000	0.05
6/30/2003	MLPL	210	4795000	0
7/1/2003	MLPL	205	1534000	-0.02380952
7/2/2003	MLPL	205	1794000	0
7/3/2003	MLPL	215	11572500	0.048780488
7/4/2003	MLPL	215	14955000	0
7/7/2003	MLPL	225	5908500	0.046511628
7/8/2003	MLPL	230	22972500	0.022222222
7/9/2003	MLPL	225	7608000	-0.02173913
7/10/2003	MLPL	220	2305500	-0.02222222
7/11/2003	MLPL	230	4527500	0.045454545
7/14/2003	MLPL	220	5478000	-0.04347826
7/15/2003	MLPL	215	5490500	-0.02272727
7/16/2003	MLPL	215	1731000	0
7/17/2003	MLPL	215	582500	0
7/18/2003	MLPL	215	2584500	0
7/21/2003	MLPL	205	1488000	-0.04651163
7/22/2003	MLPL	195	14558500	-0.04878049
7/23/2003	MLPL	195	1460500	0
7/24/2003	MLPL	190	5705000	-0.02564103
7/25/2003	MLPL	200	6288500	0.052631579
7/28/2003	MLPL	190	1826000	-0.05
7/29/2003	MLPL	190	1801500	0
7/30/2003	MLPL	190	2463000	0
7/31/2003	MLPL	195	3717000	0.026315789
8/1/2003	MLPL	205	20332000	0.051282051
8/4/2003	MLPL	195	5024000	-0.04878049
8/5/2003	MLPL	190	24869500	-0.02564103
8/6/2003	MLPL	200	5451000	0.052631579
8/7/2003	MLPL	210	27750500	0.05
8/8/2003	MLPL	205	7674500	-0.02380952
8/9/2003	MLPL	215	7381500	0.048780488
8/11/2003	MLPL	205	4834500	-0.04651163
8/12/2003	MLPL	200	547000	-0.02439024
8/13/2003	MLPL	205	6734000	0.025
8/14/2003	MLPL	200	5482500	-0.02439024
8/15/2003	MLPL	200	952500	0
8/19/2003	MLPL	200	1427000	0
8/20/2003	MLPL	200	1365500	0
8/21/2003	MLPL	200	131500	0
8/22/2003	MLPL	200	2902500	0
8/25/2003	MLPL	200	6080500	0
8/26/2003	MLPL	205	3382000	0.025
8/27/2003	MLPL	215	21623500	0.048780488
8/28/2003	MLPL	210	30129000	-0.02325581
8/29/2003	MLPL	205	596000	-0.02380952
9/1/2003	MLPL	200	2971500	-0.02439024

9/2/2003	MLPL	205	1637500	0.025
9/3/2003	MLPL	205	23600000	0
9/4/2003	MLPL	220	46776000	0.073170732
9/5/2003	MLPL	210	12882000	-0.04545455
9/8/2003	MLPL	215	7381500	0.023809524
9/9/2003	MLPL	210	10584000	-0.02325581
9/10/2003	MLPL	210	2873000	0
9/11/2003	MLPL	210	5008000	0
9/12/2003	MLPL	210	4080000	0
9/15/2003	MLPL	205	3118000	-0.02380952
9/16/2003	MLPL	210	985000	0.024390244
9/17/2003	MLPL	220	59821500	0.047619048
9/18/2003	MLPL	215	3150000	-0.02272727
9/19/2003	MLPL	215	3371500	0
9/23/2003	MLPL	215	1981000	0
9/24/2003	MLPL	215	3781500	0
9/25/2003	MLPL	215	6653000	0
9/26/2003	MLPL	210	5596500	-0.02325581
9/29/2003	MLPL	205	4084000	-0.02380952
9/30/2003	MLPL	210	10552000	0.024390244
10/1/2003	MLPL	210	4028000	0
10/2/2003	MLPL	205	8493500	-0.02380952
10/3/2003	MLPL	210	886500	0.024390244
10/6/2003	MLPL	210	16658500	0
10/7/2003	MLPL	210	3457500	0
10/8/2003	MLPL	210	4730000	0
10/9/2003	MLPL	215	8419500	0.023809524
10/10/2003	MLPL	215	18881000	0
10/13/2003	MLPL	220	20934000	0.023255814
10/14/2003	MLPL	230	19998000	0.045454545
10/15/2003	MLPL	260	87642000	0.130434783
10/16/2003	MLPL	250	62200000	-0.03846154
10/17/2003	MLPL	240	13204000	-0.04
10/20/2003	MLPL	245	15843000	0.020833333
10/21/2003	MLPL	235	26356500	-0.04081633
10/22/2003	MLPL	230	7205500	-0.0212766
10/23/2003	MLPL	230	30450500	0
10/24/2003	MLPL	225	3835000	-0.02173913
10/27/2003	MLPL	225	3493500	0
10/28/2003	MLPL	220	6052500	-0.02222222
10/29/2003	MLPL	215	9313500	-0.02272727
10/30/2003	MLPL	205	2180000	-0.04651163
10/31/2003	MLPL	205	9330000	0
11/3/2003	MLPL	200	4541000	-0.02439024
11/4/2003	MLPL	205	5418500	0.025
11/5/2003	MLPL	215	11050500	0.048780488
11/6/2003	MLPL	205	4345500	-0.04651163
11/7/2003	MLPL	205	2142500	0
11/10/2003	MLPL	205	1992500	0
11/11/2003	MLPL	205	3908000	0

11/12/2003	MLPL	205	1334000	0
11/13/2003	MLPL	195	8047500	-0.04878049
11/14/2003	MLPL	200	1421500	0.025641026
11/17/2003	MLPL	195	634500	-0.025
11/18/2003	MLPL	190	926500	-0.02564103
11/19/2003	MLPL	195	757500	0.026315789
11/20/2003	MLPL	200	163000	0.025641026
11/21/2003	MLPL	200	1782500	0
12/1/2003	MLPL	205	5272000	0.025
12/2/2003	MLPL	205	847500	0
12/3/2003	MLPL	205	10221000	0
12/4/2003	MLPL	205	1461500	0
12/5/2003	MLPL	205	1842000	0
12/8/2003	MLPL	210	5750000	0.024390244
12/9/2003	MLPL	215	7100500	0.023809524
12/10/2003	MLPL	210	5125000	-0.02325581
12/11/2003	MLPL	215	22438000	0.023809524
12/12/2003	MLPL	220	11588500	0.023255814
12/15/2003	MLPL	215	6355500	-0.02272727
12/16/2003	MLPL	210	1951000	-0.02325581
12/17/2003	MLPL	210	3150000	0
12/18/2003	MLPL	215	3437500	0.023809524
12/19/2003	MLPL	215	3782000	0
12/22/2003	MLPL	220	3499500	0.023255814
12/23/2003	MLPL	215	7474500	-0.02272727
12/29/2003	MLPL	215	3258000	0
12/30/2003	MLPL	210	7548500	-0.02325581

METRODATA ELEKTRONIK TBK

Date	Code	Closing price	Volume	Return
1/4/2000	MTDL	2350	24521000	0.323943662
1/5/2000	MTDL	2650	67259000	0.127659574
1/6/2000	MTDL	3150	61900500	0.188679245
1/11/2000	MTDL	3275	52626000	0.03968254
1/12/2000	MTDL	3150	43023500	-0.038167939
1/13/2000	MTDL	2550	72930500	-0.19047619
1/14/2000	MTDL	2325	17663000	-0.088235294
1/17/2000	MTDL	2625	29296500	0.129032258
1/18/2000	MTDL	2575	12278000	-0.019047619
1/19/2000	MTDL	2350	9653500	-0.087378641
1/20/2000	MTDL	2600	15579500	0.106382979
1/21/2000	MTDL	2550	4512500	-0.019230769
1/24/2000	MTDL	2500	4021500	-0.019607843
1/26/2000	MTDL	2550	4272500	0.02
1/27/2000	MTDL	1850	3090000	-0.274509804
1/28/2000	MTDL	1900	929000	0.027027027
1/31/2000	MTDL	1825	722500	-0.039473684
2/1/2000	MTDL	1775	801000	-0.02739726
2/2/2000	MTDL	1675	1212500	-0.056338028
2/3/2000	MTDL	1675	1775000	0
2/4/2000	MTDL	1825	2558000	0.089552239
2/7/2000	MTDL	1850	1566500	0.01369863
2/8/2000	MTDL	1800	894000	-0.027027027
2/9/2000	MTDL	1875	3409500	0.041666667
2/10/2000	MTDL	1850	2811500	-0.013333333
2/11/2000	MTDL	1825	1847000	-0.013513514
2/14/2000	MTDL	1775	2357500	-0.02739726
2/15/2000	MTDL	1625	4714000	-0.084507042
2/16/2000	MTDL	1500	8209500	-0.076923077
2/17/2000	MTDL	1625	33215500	0.083333333
2/18/2000	MTDL	1625	9148000	0
2/21/2000	MTDL	1625	10910500	0
2/22/2000	MTDL	1575	3999000	-0.030769231
2/23/2000	MTDL	1575	3393000	0
2/24/2000	MTDL	1525	9191000	-0.031746032
2/25/2000	MTDL	1450	5756500	-0.049180328
2/28/2000	MTDL	1450	4712000	0
3/1/2000	MTDL	1400	5932000	-0.034482759
3/2/2000	MTDL	1275	12881000	-0.089285714
3/3/2000	MTDL	1225	14330000	-0.039215686
3/6/2000	MTDL	1550	43877500	0.265306122
3/7/2000	MTDL	1475	27288000	-0.048387097
3/8/2000	MTDL	1475	15756500	0
3/9/2000	MTDL	1450	9551000	-0.016949153
3/10/2000	MTDL	1450	5587500	0
3/13/2000	MTDL	1425	3348000	-0.017241379
3/14/2000	MTDL	1400	1814500	-0.01754386

3/15/2000	MTDL	1400	1670000	0
3/17/2000	MTDL	1375	5856000	-0.017857143
3/20/2000	MTDL	1350	2266500	-0.018181818
3/21/2000	MTDL	1325	1987000	-0.018518519
3/22/2000	MTDL	1375	8726500	0.037735849
3/23/2000	MTDL	1350	4719000	-0.018181818
3/24/2000	MTDL	1350	2837500	0
3/27/2000	MTDL	1375	849500	0.018518519
3/28/2000	MTDL	1375	397000	0
3/29/2000	MTDL	1400	10992500	0.018181818
3/30/2000	MTDL	1400	51546500	0
4/3/2000	MTDL	1325	4616000	-0.053571429
4/5/2000	MTDL	1325	7511000	0
4/7/2000	MTDL	1400	3249000	0.056603774
4/10/2000	MTDL	1375	7523000	-0.017857143
4/11/2000	MTDL	1425	4647000	0.036363636
4/12/2000	MTDL	1400	4866500	-0.01754386
4/13/2000	MTDL	1300	12124500	-0.071428571
4/14/2000	MTDL	1250	5222000	-0.038461538
4/17/2000	MTDL	975	23293000	-0.22
4/18/2000	MTDL	1025	17051500	0.051282051
4/19/2000	MTDL	1025	10302500	0
4/20/2000	MTDL	1000	2755000	-0.024390244
4/24/2000	MTDL	1025	1204000	0.025
4/25/2000	MTDL	975	1801000	-0.048780488
4/26/2000	MTDL	950	6320000	-0.025641026
4/27/2000	MTDL	925	1596000	-0.026315789
4/28/2000	MTDL	925	1988500	0
5/1/2000	MTDL	925	538000	0
5/2/2000	MTDL	950	3847000	0.027027027
5/3/2000	MTDL	925	1211500	-0.026315789
5/4/2000	MTDL	950	1530000	0.027027027
5/5/2000	MTDL	925	839500	-0.026315789
5/8/2000	MTDL	900	2296500	-0.027027027
5/9/2000	MTDL	875	1129500	-0.027777778
5/10/2000	MTDL	875	1810500	0
5/11/2000	MTDL	800	2579500	-0.085714286
5/12/2000	MTDL	775	3203500	-0.03125
5/15/2000	MTDL	725	3159500	-0.064516129
5/16/2000	MTDL	675	4235500	-0.068965517
5/17/2000	MTDL	725	3253000	0.074074074
5/19/2000	MTDL	725	2184000	0
5/22/2000	MTDL	700	850000	-0.034482759
5/23/2000	MTDL	700	1135500	0
5/24/2000	MTDL	675	3661500	-0.035714286
5/25/2000	MTDL	750	8194500	0.111111111
5/26/2000	MTDL	775	18246500	0.033333333
5/29/2000	MTDL	700	4803500	-0.096774194
5/30/2000	MTDL	725	7646500	0.035714286
5/31/2000	MTDL	700	5378500	-0.034482759

6/2/2000	MTDL	650	3065000	-0.071428571
6/5/2000	MTDL	700	1575000	0.076923077
6/6/2000	MTDL	700	984000	0
6/7/2000	MTDL	700	1436000	0
6/8/2000	MTDL	725	4903000	0.035714286
6/9/2000	MTDL	700	1424000	-0.034482759
6/12/2000	MTDL	675	1577000	-0.035714286
6/13/2000	MTDL	675	394000	0
6/14/2000	MTDL	675	351500	0
6/16/2000	MTDL	675	2543500	0
6/19/2000	MTDL	725	5007500	0.074074074
6/20/2000	MTDL	725	4138000	0
6/21/2000	MTDL	825	22283500	0.137931034
6/22/2000	MTDL	850	22810000	0.03030303
6/23/2000	MTDL	825	6066000	-0.029411765
6/26/2000	MTDL	925	12461500	0.121212121
6/27/2000	MTDL	900	4016500	-0.027027027
6/28/2000	MTDL	875	2518000	-0.027777778
6/29/2000	MTDL	900	476500	0.028571429
6/30/2000	MTDL	875	126500	-0.027777778
7/3/2000	MTDL	850	813000	-0.028571429
7/4/2000	MTDL	880	2605000	0.035294118
7/5/2000	MTDL	850	1378000	-0.034090909
7/6/2000	MTDL	825	290500	-0.029411765
7/7/2000	MTDL	815	909500	-0.012121212
7/10/2000	MTDL	785	480000	-0.036809816
7/11/2000	MTDL	815	830500	0.038216561
7/12/2000	MTDL	820	1350000	0.006134969
7/13/2000	MTDL	840	3471000	0.024390244
7/14/2000	MTDL	825	1108500	-0.017857143
7/17/2000	MTDL	815	170500	-0.012121212
7/18/2000	MTDL	815	215000	0
7/19/2000	MTDL	840	3511500	0.030674847
7/20/2000	MTDL	825	1787000	-0.017857143
7/21/2000	MTDL	840	1834000	0.018181818
7/24/2000	MTDL	825	1453000	-0.017857143
7/25/2000	MTDL	830	5767500	0.006060606
7/26/2000	MTDL	810	1022000	-0.024096386
7/27/2000	MTDL	820	297000	0.012345679
7/28/2000	MTDL	815	355500	-0.006097561
7/31/2000	MTDL	800	321000	-0.018404908
8/1/2000	MTDL	790	461000	-0.0125
8/2/2000	MTDL	770	835500	-0.025316456
8/3/2000	MTDL	775	535500	0.006493506
8/4/2000	MTDL	775	202000	0
8/7/2000	MTDL	750	596000	-0.032258065
8/8/2000	MTDL	730	348000	-0.026666667
8/9/2000	MTDL	745	2442000	0.020547945
8/10/2000	MTDL	755	1038500	0.013422819
8/11/2000	MTDL	775	1336000	0.026490066

8/14/2000	MTDL	810	7391000	0.04516129
8/15/2000	MTDL	830	9903500	0.024691358
8/16/2000	MTDL	825	3417000	-0.006024096
8/18/2000	MTDL	825	2092000	0
8/21/2000	MTDL	820	441500	-0.006060606
8/22/2000	MTDL	825	1603500	0.006097561
8/23/2000	MTDL	830	1252000	0.006060606
8/24/2000	MTDL	785	3458000	-0.054216867
8/25/2000	MTDL	830	3399500	0.057324841
8/28/2000	MTDL	805	918000	-0.030120482
8/29/2000	MTDL	800	4551500	-0.00621118
8/30/2000	MTDL	790	2706000	-0.0125
8/31/2000	MTDL	805	1846500	0.018987342
9/1/2000	MTDL	790	518000	-0.01863354
9/4/2000	MTDL	805	652000	0.018987342
9/5/2000	MTDL	795	580000	-0.01242236
9/6/2000	MTDL	795	1544000	0
9/7/2000	MTDL	795	1439500	0
9/8/2000	MTDL	795	1078000	0
9/11/2000	MTDL	775	324500	-0.025157233
9/12/2000	MTDL	755	379000	-0.025806452
9/13/2000	MTDL	740	513500	-0.01986755
9/18/2000	MTDL	615	811500	-0.168918919
9/19/2000	MTDL	650	1992000	0.056910569
9/20/2000	MTDL	650	2278000	0
9/21/2000	MTDL	620	778500	-0.046153846
9/22/2000	MTDL	575	647500	-0.072580645
9/25/2000	MTDL	565	915500	-0.017391304
9/26/2000	MTDL	575	365000	0.017699115
9/27/2000	MTDL	555	977000	-0.034782609
9/28/2000	MTDL	550	1974000	-0.009009009
9/29/2000	MTDL	575	3169500	0.045454545
10/2/2000	MTDL	595	3843500	0.034782609
10/3/2000	MTDL	595	1580500	0
10/4/2000	MTDL	585	908500	-0.016806723
10/5/2000	MTDL	585	1946500	0
10/6/2000	MTDL	580	269500	-0.008547009
10/9/2000	MTDL	565	200000	-0.025862069
10/10/2000	MTDL	560	178500	-0.008849558
10/11/2000	MTDL	570	349000	0.017857143
10/12/2000	MTDL	565	246000	-0.00877193
10/13/2000	MTDL	560	1386000	-0.008849558
10/16/2000	MTDL	555	508500	-0.008928571
10/17/2000	MTDL	575	523500	0.036036036
10/18/2000	MTDL	575	407000	0
10/19/2000	MTDL	580	637500	0.008695652
10/20/2000	MTDL	600	2027000	0.034482759
10/23/2000	MTDL	600	263500	0
10/24/2000	MTDL	600	198000	0
10/26/2000	MTDL	575	572000	-0.041666667

10/27/2000	MTDL	575	213000	0
10/30/2000	MTDL	550	180500	-0.043478261
10/31/2000	MTDL	550	341500	0
11/1/2000	MTDL	550	189500	0
11/2/2000	MTDL	550	355000	0
11/3/2000	MTDL	550	135500	0
11/6/2000	MTDL	550	62500	0
11/7/2000	MTDL	550	1133500	0
11/8/2000	MTDL	550	84500	0
11/9/2000	MTDL	550	155000	0
11/10/2000	MTDL	550	255500	0
11/13/2000	MTDL	550	185000	0
11/14/2000	MTDL	500	46500	-0.090909091
11/15/2000	MTDL	500	983000	0
11/16/2000	MTDL	500	438000	0
11/17/2000	MTDL	500	89000	0
11/20/2000	MTDL	525	989500	0.05
11/21/2000	MTDL	525	54000	0
11/22/2000	MTDL	525	522000	0
11/23/2000	MTDL	525	231500	0
11/24/2000	MTDL	525	66500	0
11/27/2000	MTDL	525	49500	0
11/28/2000	MTDL	475	1993000	-0.095238095
11/29/2000	MTDL	480	2722000	0.010526316
11/30/2000	MTDL	480	423500	0
12/1/2000	MTDL	480	112000	0
12/4/2000	MTDL	470	754500	-0.020833333
12/5/2000	MTDL	470	194000	0
12/6/2000	MTDL	505	5013000	0.074468085
12/7/2000	MTDL	500	1327500	-0.00990099
12/8/2000	MTDL	475	20500	-0.05
12/11/2000	MTDL	465	1338000	-0.021052632
12/12/2000	MTDL	470	862000	0.010752688
12/13/2000	MTDL	470	399000	0
12/14/2000	MTDL	460	400000	-0.021276596
12/15/2000	MTDL	455	560500	-0.010869565
12/18/2000	MTDL	460	7000	0.010989011
12/19/2000	MTDL	465	312500	0.010869565
12/20/2000	MTDL	470	516000	0.010752688
12/21/2000	MTDL	460	495000	-0.021276596
12/22/2000	MTDL	465	945500	0.010869565
1/2/2001	MTDL	455	199000	-0.021505376
1/3/2001	MTDL	430	259000	-0.054945055
1/4/2001	MTDL	425	784500	-0.011627907
1/5/2001	MTDL	440	1584500	0.035294118
1/8/2001	MTDL	420	376500	-0.045454545
1/9/2001	MTDL	430	583000	0.023809524
1/10/2001	MTDL	435	422500	0.011627907
1/11/2001	MTDL	430	824500	-0.011494253
1/12/2001	MTDL	435	493500	0.011627907

1/15/2001	MTDL	445	752000	0.022988506
1/16/2001	MTDL	440	1107500	-0.011235955
1/17/2001	MTDL	450	1242500	0.022727273
1/18/2001	MTDL	435	697000	-0.033333333
1/19/2001	MTDL	425	656500	-0.022988506
1/22/2001	MTDL	425	711000	0
1/23/2001	MTDL	435	334000	0.023529412
1/24/2001	MTDL	430	39000	-0.011494253
1/25/2001	MTDL	430	133500	0
1/26/2001	MTDL	425	768500	-0.011627907
1/29/2001	MTDL	425	569500	0
1/30/2001	MTDL	465	6720500	0.094117647
1/31/2001	MTDL	455	12432000	-0.021505376
2/1/2001	MTDL	450	4425000	-0.010989011
2/2/2001	MTDL	455	2759500	0.011111111
2/5/2001	MTDL	445	2481500	-0.021978022
2/6/2001	MTDL	440	599000	-0.011235955
2/7/2001	MTDL	430	515000	-0.022727273
2/8/2001	MTDL	435	316000	0.011627907
2/9/2001	MTDL	425	305500	-0.022988506
2/12/2001	MTDL	425	209500	0
2/13/2001	MTDL	420	691000	-0.011764706
2/14/2001	MTDL	415	415000	-0.011904762
2/15/2001	MTDL	415	6256000	0
2/16/2001	MTDL	395	3720000	-0.048192771
2/19/2001	MTDL	395	277000	0
2/20/2001	MTDL	390	394000	-0.012658228
2/21/2001	MTDL	390	536000	0
2/22/2001	MTDL	385	152000	-0.012820513
2/23/2001	MTDL	380	759500	-0.012987013
2/26/2001	MTDL	355	1793500	-0.065789474
2/27/2001	MTDL	355	3500000	0
2/28/2001	MTDL	335	1835500	-0.056338028
3/1/2001	MTDL	335	775500	0
3/2/2001	MTDL	335	644000	0
3/6/2001	MTDL	330	213500	-0.014925373
3/7/2001	MTDL	345	5894000	0.045454545
3/8/2001	MTDL	350	7878000	0.014492754
3/9/2001	MTDL	335	4844500	-0.042857143
3/12/2001	MTDL	310	2701500	-0.074626866
3/13/2001	MTDL	300	2316000	-0.032258065
3/14/2001	MTDL	300	1408000	0
3/15/2001	MTDL	300	955500	0
3/16/2001	MTDL	290	715000	-0.033333333
3/19/2001	MTDL	270	837500	-0.068965517
3/20/2001	MTDL	250	847000	-0.074074074
3/21/2001	MTDL	265	1493000	0.06
3/22/2001	MTDL	245	5808500	-0.075471698
3/23/2001	MTDL	255	2818500	0.040816327
3/27/2001	MTDL	275	3245000	0.078431373

3/28/2001	MTDL	265	1299000	-0.036363636
3/29/2001	MTDL	270	3901000	0.018867925
3/30/2001	MTDL	275	2687500	0.018518519
4/2/2001	MTDL	270	940500	-0.018181818
4/3/2001	MTDL	270	1760500	0
4/4/2001	MTDL	320	34940500	0.185185185
4/5/2001	MTDL	345	98758000	0.078125
4/6/2001	MTDL	310	67581000	-0.101449275
4/9/2001	MTDL	340	32851500	0.096774194
4/10/2001	MTDL	325	7588500	-0.044117647
4/11/2001	MTDL	320	4543000	-0.015384615
4/12/2001	MTDL	325	5637500	0.015625
4/16/2001	MTDL	315	1923500	-0.030769231
4/17/2001	MTDL	300	3231000	-0.047619048
4/18/2001	MTDL	280	3012500	-0.066666667
4/19/2001	MTDL	255	10614500	-0.089285714
4/20/2001	MTDL	240	9024500	-0.058823529
4/23/2001	MTDL	270	26853000	0.125
4/24/2001	MTDL	280	17422500	0.037037037
4/25/2001	MTDL	315	37945000	0.125
4/26/2001	MTDL	295	14698500	-0.063492063
4/27/2001	MTDL	305	10520000	0.033898305
4/30/2001	MTDL	310	10600000	0.016393443
5/1/2001	MTDL	325	22306000	0.048387097
5/2/2001	MTDL	345	26665000	0.061538462
5/3/2001	MTDL	350	15499500	0.014492754
5/4/2001	MTDL	360	15865500	0.028571429
5/8/2001	MTDL	350	7368000	-0.027777778
5/9/2001	MTDL	340	8572500	-0.028571429
5/10/2001	MTDL	355	17620000	0.044117647
5/11/2001	MTDL	360	5500500	0.014084507
5/14/2001	MTDL	365	4088000	0.013888889
5/15/2001	MTDL	380	20218000	0.04109589
5/16/2001	MTDL	405	26117000	0.065789474
5/17/2001	MTDL	410	20749500	0.012345679
5/18/2001	MTDL	405	6940000	-0.012195122
5/21/2001	MTDL	405	8821000	0
5/22/2001	MTDL	405	8143000	0
5/23/2001	MTDL	415	5831000	0.024691358
5/25/2001	MTDL	420	11729000	0.012048193
5/28/2001	MTDL	410	8575500	-0.023809524
5/29/2001	MTDL	415	14075000	0.012195122
5/30/2001	MTDL	410	28496000	-0.012048193
5/31/2001	MTDL	405	9009000	-0.012195122
6/1/2001	MTDL	405	6052500	0
6/5/2001	MTDL	410	9989000	0.012345679
6/6/2001	MTDL	405	6258000	-0.012195122
6/7/2001	MTDL	390	8729500	-0.037037037
6/8/2001	MTDL	385	13651000	-0.012820513
6/11/2001	MTDL	390	3788500	0.012987013

6/12/2001	MTDL	395	6552500	0.012820513
6/13/2001	MTDL	385	2013000	-0.025316456
6/14/2001	MTDL	380	562500	-0.012987013
6/15/2001	MTDL	385	720000	0.013157895
6/18/2001	MTDL	385	1570000	0
6/19/2001	MTDL	380	1557000	-0.012987013
6/20/2001	MTDL	390	2897500	0.026315789
6/21/2001	MTDL	390	3438000	0
6/22/2001	MTDL	390	1789000	0
6/25/2001	MTDL	400	7501000	0.025641026
6/26/2001	MTDL	415	12243500	0.0375
6/27/2001	MTDL	400	12970500	-0.036144578
6/28/2001	MTDL	390	6457500	-0.025
6/29/2001	MTDL	390	1123500	0
7/2/2001	MTDL	395	1127000	0.012820513
7/3/2001	MTDL	405	6285000	0.025316456
7/4/2001	MTDL	400	1491000	-0.012345679
7/5/2001	MTDL	400	3769000	0
7/6/2001	MTDL	400	368500	0
7/9/2001	MTDL	395	1519500	-0.0125
7/10/2001	MTDL	395	1780000	0
7/11/2001	MTDL	405	7857000	0.025316456
7/12/2001	MTDL	410	14509500	0.012345679
7/13/2001	MTDL	410	2671000	0
7/16/2001	MTDL	405	1617500	-0.012195122
7/17/2001	MTDL	405	1011500	0
7/18/2001	MTDL	415	2604000	0.024691358
7/19/2001	MTDL	435	46486500	0.048192771
7/20/2001	MTDL	435	11139500	0
7/23/2001	MTDL	445	16749500	0.022988506
7/24/2001	MTDL	440	10061000	-0.011235955
7/25/2001	MTDL	430	11433500	-0.022727273
7/26/2001	MTDL	415	4538000	-0.034883721
7/27/2001	MTDL	425	22843000	0.024096386
7/30/2001	MTDL	435	8659000	0.023529412
7/31/2001	MTDL	430	4447000	-0.011494253
8/1/2001	MTDL	425	2208000	-0.011627907
8/2/2001	MTDL	415	3617500	-0.023529412
8/3/2001	MTDL	420	2327000	0.012048193
8/6/2001	MTDL	415	2443000	-0.011904762
8/7/2001	MTDL	420	7921000	0.012048193
8/8/2001	MTDL	430	4462000	0.023809524
8/9/2001	MTDL	420	6970000	-0.023255814
8/10/2001	MTDL	430	3623000	0.023809524
8/13/2001	MTDL	435	12423500	0.011627907
8/14/2001	MTDL	435	5522500	0
8/15/2001	MTDL	425	609000	-0.022988506
8/16/2001	MTDL	425	1632000	0
8/20/2001	MTDL	420	868500	-0.011764706
8/21/2001	MTDL	425	971500	0.011904762

8/22/2001	MTDL	435	4454000	0.023529412
8/23/2001	MTDL	435	2198000	0
8/24/2001	MTDL	430	1712500	-0.011494253
8/27/2001	MTDL	435	4612000	0.011627907
8/28/2001	MTDL	430	4196500	-0.011494253
8/29/2001	MTDL	440	4661500	0.023255814
8/30/2001	MTDL	450	26342000	0.022727273
8/31/2001	MTDL	455	7269000	0.011111111
9/3/2001	MTDL	445	3515500	-0.021978022
9/4/2001	MTDL	445	1604000	0
9/5/2001	MTDL	440	1407000	-0.011235955
9/6/2001	MTDL	440	2543500	0
9/7/2001	MTDL	435	1347500	-0.011363636
9/10/2001	MTDL	435	1490000	0
9/11/2001	MTDL	435	2718000	0
9/12/2001	MTDL	420	4485500	-0.034482759
9/13/2001	MTDL	420	1055500	0
9/14/2001	MTDL	435	8110500	0.035714286
9/17/2001	MTDL	405	6366000	-0.068965517
9/18/2001	MTDL	410	3696000	0.012345679
9/19/2001	MTDL	415	1649000	0.012195122
9/20/2001	MTDL	410	6023000	-0.012048193
9/21/2001	MTDL	410	942000	0
9/24/2001	MTDL	405	3172500	-0.012195122
9/25/2001	MTDL	400	3219500	-0.012345679
9/26/2001	MTDL	390	2575000	-0.025
9/27/2001	MTDL	395	4572500	0.012820513
9/28/2001	MTDL	400	3775000	0.012658228
10/1/2001	MTDL	390	715000	-0.025
10/2/2001	MTDL	375	1358000	-0.038461538
10/3/2001	MTDL	365	1565000	-0.026666667
10/4/2001	MTDL	390	3970500	0.068493151
10/5/2001	MTDL	385	2294500	-0.012820513
10/8/2001	MTDL	360	3407000	-0.064935065
10/9/2001	MTDL	375	3914000	0.041666667
10/10/2001	MTDL	365	582500	-0.026666667
10/11/2001	MTDL	365	1205000	0
10/12/2001	MTDL	365	1549500	0
10/16/2001	MTDL	370	389000	0.01369863
10/17/2001	MTDL	365	1996500	-0.013513514
10/18/2001	MTDL	390	20067000	0.068493151
10/19/2001	MTDL	385	5525500	-0.012820513
10/22/2001	MTDL	380	2695500	-0.012987013
10/23/2001	MTDL	380	2844500	0
10/24/2001	MTDL	380	824500	0
10/25/2001	MTDL	370	1750500	-0.026315789
10/26/2001	MTDL	360	2125000	-0.027027027
10/29/2001	MTDL	365	6155000	0.013888889
10/30/2001	MTDL	370	6602500	0.01369863
10/31/2001	MTDL	380	4860000	0.027027027

11/1/2001	MTDL	390	4357500	0.026315789
11/2/2001	MTDL	425	27251000	0.08974359
11/5/2001	MTDL	415	9634000	-0.023529412
11/6/2001	MTDL	420	4648000	0.012048193
11/7/2001	MTDL	405	3595000	-0.035714286
11/8/2001	MTDL	410	2889000	0.012345679
11/9/2001	MTDL	410	1943000	0
11/12/2001	MTDL	405	1847500	-0.012195122
11/13/2001	MTDL	395	1791000	-0.024691358
11/14/2001	MTDL	395	6056000	0
11/15/2001	MTDL	135	2805500	-0.658227848
11/16/2001	MTDL	135	168000	0
11/19/2001	MTDL	135	58000	0
11/20/2001	MTDL	130	1456000	-0.037037037
11/21/2001	MTDL	130	721000	0
11/22/2001	MTDL	130	98000	0
11/23/2001	MTDL	130	18326500	0
11/26/2001	MTDL	130	14391500	0
11/27/2001	MTDL	130	20854500	0
11/28/2001	MTDL	120	13517500	-0.076923077
11/29/2001	MTDL	125	150500	0.041666667
11/30/2001	MTDL	125	2842500	0
12/3/2001	MTDL	125	602500	0
12/4/2001	MTDL	125	12346500	0
12/5/2001	MTDL	125	29567000	0
12/6/2001	MTDL	125	20232000	0
12/7/2001	MTDL	125	18622000	0
12/10/2001	MTDL	125	10075500	0
12/11/2001	MTDL	125	20781000	0
12/12/2001	MTDL	125	50150000	0
12/13/2001	MTDL	120	19844500	-0.04
12/19/2001	MTDL	125	532500	0.041666667
12/20/2001	MTDL	120	235500	-0.04
12/21/2001	MTDL	120	970000	0
12/26/2001	MTDL	120	1915000	0
12/27/2001	MTDL	120	180000	0
12/28/2001	MTDL	120	2236000	0
1/2/2002	MTDL	115	933500	-0.041666667
1/3/2002	MTDL	115	632000	0
1/4/2002	MTDL	115	3355000	0
1/7/2002	MTDL	120	663000	0.043478261
1/8/2002	MTDL	115	2636500	-0.041666667
1/9/2002	MTDL	115	9200500	0
1/10/2002	MTDL	120	11122000	0.043478261
1/11/2002	MTDL	120	13164500	0
1/14/2002	MTDL	125	9303500	0.041666667
1/15/2002	MTDL	125	8637500	0
1/16/2002	MTDL	125	11808500	0
1/17/2002	MTDL	125	74500	0
1/18/2002	MTDL	125	4450500	0

1/21/2002	MTDL	125	20000	0
1/22/2002	MTDL	125	404000	0
1/23/2002	MTDL	125	371500	0
1/24/2002	MTDL	125	4268500	0
1/25/2002	MTDL	125	2549500	0
1/28/2002	MTDL	125	1078500	0
1/29/2002	MTDL	125	3314000	0
1/30/2002	MTDL	125	5526500	0
1/31/2002	MTDL	125	412000	0
2/1/2002	MTDL	130	4863500	0.04
2/4/2002	MTDL	130	269000	0
2/5/2002	MTDL	130	2542000	0
2/6/2002	MTDL	120	3133000	-0.076923077
2/7/2002	MTDL	120	7594500	0
2/8/2002	MTDL	125	266000	0.041666667
2/11/2002	MTDL	125	585500	0
2/13/2002	MTDL	125	982000	0
2/14/2002	MTDL	125	1182500	0
2/15/2002	MTDL	125	6109500	0
2/18/2002	MTDL	125	4635500	0
2/19/2002	MTDL	125	14844500	0
2/20/2002	MTDL	125	6938000	0
2/21/2002	MTDL	125	42293000	0
2/25/2002	MTDL	120	8983000	-0.04
2/26/2002	MTDL	125	1514000	0.041666667
2/27/2002	MTDL	120	1004500	-0.04
2/28/2002	MTDL	125	4609500	0.041666667
3/1/2002	MTDL	125	1449500	0
3/4/2002	MTDL	125	101000	0
3/5/2002	MTDL	125	559500	0
3/6/2002	MTDL	125	416000	0
3/7/2002	MTDL	125	2012500	0
3/8/2002	MTDL	120	258000	-0.04
3/11/2002	MTDL	125	167000	0.041666667
3/12/2002	MTDL	140	65232000	0.12
3/13/2002	MTDL	140	24037000	0
3/14/2002	MTDL	130	7553000	-0.071428571
3/18/2002	MTDL	135	1897500	0.038461538
3/19/2002	MTDL	130	2995500	-0.037037037
3/20/2002	MTDL	140	46731500	0.076923077
3/21/2002	MTDL	140	27484500	0
3/22/2002	MTDL	140	7928500	0
3/25/2002	MTDL	140	5921500	0
3/26/2002	MTDL	140	2461500	0
3/27/2002	MTDL	140	577500	0
3/28/2002	MTDL	130	2390000	-0.071428571
4/1/2002	MTDL	135	581500	0.038461538
4/2/2002	MTDL	135	3059000	0
4/3/2002	MTDL	135	2401500	0
4/4/2002	MTDL	145	33366500	0.074074074

4/5/2002	MTDL	150	6001000	0.034482759
4/8/2002	MTDL	150	41060000	0
4/9/2002	MTDL	155	15612500	0.033333333
4/10/2002	MTDL	180	118726000	0.161290323
4/11/2002	MTDL	180	64415000	0
4/12/2002	MTDL	185	29828500	0.027777778
4/15/2002	MTDL	190	37948000	0.027027027
4/16/2002	MTDL	195	31135000	0.026315789
4/17/2002	MTDL	235	137462500	0.205128205
4/18/2002	MTDL	230	57802000	-0.021276596
4/19/2002	MTDL	230	15778000	0
4/22/2002	MTDL	220	7616500	-0.043478261
4/23/2002	MTDL	220	9910500	0
4/24/2002	MTDL	225	36131500	0.022727273
4/25/2002	MTDL	210	17984000	-0.066666667
4/26/2002	MTDL	215	5673000	0.023809524
4/29/2002	MTDL	210	3494500	-0.023255814
4/30/2002	MTDL	200	18906500	-0.047619048
5/1/2002	MTDL	195	4658000	-0.025
5/2/2002	MTDL	210	16064500	0.076923077
5/3/2002	MTDL	205	6896500	-0.023809524
5/6/2002	MTDL	210	16152500	0.024390244
5/7/2002	MTDL	210	3877000	0
5/8/2002	MTDL	215	7754000	0.023809524
5/10/2002	MTDL	210	6689500	-0.023255814
5/13/2002	MTDL	210	3259500	0
5/14/2002	MTDL	230	104240000	0.095238095
5/15/2002	MTDL	230	66577000	0
5/16/2002	MTDL	230	27876000	0
5/17/2002	MTDL	225	13353000	-0.02173913
5/20/2002	MTDL	215	8313500	-0.044444444
5/21/2002	MTDL	220	13635000	0.023255814
5/22/2002	MTDL	205	24863500	-0.068181818
5/23/2002	MTDL	195	41262500	-0.048780488
5/24/2002	MTDL	200	7646500	0.025641026
5/27/2002	MTDL	200	5176500	0
5/28/2002	MTDL	195	9702500	-0.025
5/29/2002	MTDL	195	16938500	0
5/30/2002	MTDL	195	10550000	0
5/31/2002	MTDL	200	12650500	0.025641026
6/3/2002	MTDL	195	7960000	-0.025
6/4/2002	MTDL	200	4060500	0.025641026
6/5/2002	MTDL	195	2074000	-0.025
6/6/2002	MTDL	190	6203500	-0.025641026
6/7/2002	MTDL	195	4687500	0.026315789
6/10/2002	MTDL	190	4500500	-0.025641026
6/11/2002	MTDL	180	5863500	-0.052631579
6/12/2002	MTDL	170	11168000	-0.055555556
6/13/2002	MTDL	185	19871500	0.088235294
6/14/2002	MTDL	185	16312500	0

6/17/2002	MTDL	185	4479500	0
6/18/2002	MTDL	190	12430000	0.027027027
6/19/2002	MTDL	180	9035000	-0.052631579
6/20/2002	MTDL	180	2273500	0
6/21/2002	MTDL	180	934000	0
6/24/2002	MTDL	175	213500	-0.027777778
6/25/2002	MTDL	175	2528000	0
6/26/2002	MTDL	170	2077000	-0.028571429
6/27/2002	MTDL	170	3649000	0
6/28/2002	MTDL	165	2902500	-0.029411765
7/1/2002	MTDL	160	3682000	-0.03030303
7/2/2002	MTDL	155	3503000	-0.03125
7/3/2002	MTDL	155	1632500	0
7/4/2002	MTDL	155	2290500	0
7/5/2002	MTDL	155	2622000	0
7/8/2002	MTDL	150	1127500	-0.032258065
7/9/2002	MTDL	150	3386000	0
7/10/2002	MTDL	150	2468000	0
7/11/2002	MTDL	140	4024500	-0.066666667
7/12/2002	MTDL	140	5027000	0
7/15/2002	MTDL	135	2445000	-0.035714286
7/16/2002	MTDL	135	277000	0
7/17/2002	MTDL	130	2160500	-0.037037037
7/18/2002	MTDL	145	4938000	0.115384615
7/19/2002	MTDL	145	1221500	0
7/22/2002	MTDL	135	1278500	-0.068965517
7/23/2002	MTDL	130	1154500	-0.037037037
7/24/2002	MTDL	125	5720000	-0.038461538
7/25/2002	MTDL	130	8698500	0.04
7/26/2002	MTDL	125	2402500	-0.038461538
7/29/2002	MTDL	125	2352500	0
7/30/2002	MTDL	130	8111000	0.04
7/31/2002	MTDL	125	1865500	-0.038461538
8/1/2002	MTDL	120	977000	-0.04
8/2/2002	MTDL	120	2237500	0
8/5/2002	MTDL	125	784000	0.041666667
8/6/2002	MTDL	120	1372000	-0.04
8/7/2002	MTDL	125	167500	0.041666667
8/8/2002	MTDL	125	2218000	0
8/9/2002	MTDL	125	3252000	0
8/12/2002	MTDL	120	1075000	-0.04
8/13/2002	MTDL	120	815000	0
8/14/2002	MTDL	120	1866500	0
8/15/2002	MTDL	130	10117000	0.083333333
8/16/2002	MTDL	125	4581000	-0.038461538
8/19/2002	MTDL	125	1720500	0
8/20/2002	MTDL	135	9323500	0.08
8/21/2002	MTDL	130	2244500	-0.037037037
8/22/2002	MTDL	130	5448000	0
8/23/2002	MTDL	130	1578500	0

8/26/2002	MTDL	130	558000	0
8/27/2002	MTDL	125	727500	-0.038461538
8/28/2002	MTDL	120	175500	-0.04
8/29/2002	MTDL	125	357000	0.041666667
8/30/2002	MTDL	125	60000	0
9/2/2002	MTDL	125	295500	0
9/3/2002	MTDL	120	1009500	-0.04
9/4/2002	MTDL	115	4066500	-0.041666667
9/5/2002	MTDL	120	3683500	0.043478261
9/6/2002	MTDL	120	415000	0
9/9/2002	MTDL	120	322500	0
9/10/2002	MTDL	115	551000	-0.041666667
9/11/2002	MTDL	115	759000	0
9/12/2002	MTDL	120	1923000	0.043478261
9/13/2002	MTDL	115	272000	-0.041666667
9/16/2002	MTDL	110	60000	-0.043478261
9/17/2002	MTDL	115	1203000	0.045454545
9/18/2002	MTDL	110	1454500	-0.043478261
9/19/2002	MTDL	105	663000	-0.045454545
9/20/2002	MTDL	110	1183500	0.047619048
9/23/2002	MTDL	110	246000	0
9/24/2002	MTDL	105	1055000	-0.045454545
9/25/2002	MTDL	105	140000	0
9/26/2002	MTDL	110	448000	0.047619048
9/27/2002	MTDL	105	523000	-0.045454545
9/30/2002	MTDL	100	1313000	-0.047619048
10/1/2002	MTDL	100	2286000	0
10/2/2002	MTDL	105	8697500	0.05
10/3/2002	MTDL	105	838000	0
10/7/2002	MTDL	100	1333000	-0.047619048
10/8/2002	MTDL	95	217000	-0.05
10/9/2002	MTDL	100	4216500	0.052631579
10/10/2002	MTDL	100	1314500	0
10/11/2002	MTDL	100	1080500	0
10/14/2002	MTDL	85	3684500	-0.15
10/15/2002	MTDL	90	7795500	0.058823529
10/16/2002	MTDL	90	6509000	0
10/17/2002	MTDL	85	737000	-0.055555556
10/18/2002	MTDL	95	8059500	0.117647059
10/21/2002	MTDL	95	313000	0
10/22/2002	MTDL	90	1429500	-0.052631579
10/23/2002	MTDL	95	700500	0.055555556
10/24/2002	MTDL	95	273500	0
10/25/2002	MTDL	95	325000	0
10/28/2002	MTDL	100	2401500	0.052631579
10/29/2002	MTDL	105	6454000	0.05
10/30/2002	MTDL	105	569000	0
10/31/2002	MTDL	110	3838000	0.047619048
11/1/2002	MTDL	120	4777500	0.090909091
11/4/2002	MTDL	125	6575500	0.041666667

11/5/2002	MTDL	120	6449500	-0.04
11/6/2002	MTDL	120	1347500	0
11/7/2002	MTDL	115	414500	-0.041666667
11/8/2002	MTDL	125	6478500	0.086956522
11/11/2002	MTDL	120	1197500	-0.04
11/12/2002	MTDL	120	348500	0
11/13/2002	MTDL	120	385500	0
11/14/2002	MTDL	120	842000	0
11/15/2002	MTDL	120	525500	0
11/18/2002	MTDL	120	137000	0
11/19/2002	MTDL	120	440000	0
11/20/2002	MTDL	120	157000	0
11/21/2002	MTDL	120	725000	0
11/22/2002	MTDL	120	2417500	0
11/25/2002	MTDL	115	5679000	-0.041666667
11/26/2002	MTDL	115	584500	0
11/27/2002	MTDL	115	456000	0
11/28/2002	MTDL	115	46500	0
11/29/2002	MTDL	120	1011500	0.043478261
12/2/2002	MTDL	115	23000	-0.041666667
12/3/2002	MTDL	115	308000	0
12/4/2002	MTDL	115	714500	0
12/11/2002	MTDL	115	274000	0
12/12/2002	MTDL	115	458500	0
12/13/2002	MTDL	115	516500	0
12/16/2002	MTDL	110	3884000	-0.043478261
12/17/2002	MTDL	110	925000	0
12/18/2002	MTDL	110	7366500	0
12/19/2002	MTDL	115	10346500	0.045454545
12/20/2002	MTDL	115	773000	0
12/23/2002	MTDL	115	1585000	0
12/27/2002	MTDL	115	3701000	0
1/2/2003	MTDL	105	5500	-0.086956522
1/3/2003	MTDL	105	418500	0
1/6/2003	MTDL	105	1288500	0
1/7/2003	MTDL	100	365500	-0.047619048
1/8/2003	MTDL	100	1088000	0
1/9/2003	MTDL	100	774500	0
1/10/2003	MTDL	100	1011000	0
1/13/2003	MTDL	100	907500	0
1/14/2003	MTDL	105	1539000	0.05
1/15/2003	MTDL	100	2365000	-0.047619048
1/16/2003	MTDL	100	1062000	0
1/17/2003	MTDL	100	467000	0
1/20/2003	MTDL	100	406000	0
1/21/2003	MTDL	95	1552500	-0.05
1/22/2003	MTDL	95	381500	0
1/23/2003	MTDL	100	1232500	0.052631579
1/24/2003	MTDL	95	678000	-0.05
1/27/2003	MTDL	95	735000	0

1/28/2003	MTDL	95	861500	0
1/29/2003	MTDL	90	749000	-0.052631579
1/30/2003	MTDL	90	235500	0
1/31/2003	MTDL	90	1097500	0
2/3/2003	MTDL	90	84000	0
2/4/2003	MTDL	90	67000	0
2/5/2003	MTDL	90	163000	0
2/6/2003	MTDL	90	322000	0
2/7/2003	MTDL	85	1093500	-0.055555556
2/9/2003	MTDL	105	400000	0.235294118
2/10/2003	MTDL	85	1398500	-0.19047619
2/11/2003	MTDL	90	442500	0.058823529
2/13/2003	MTDL	90	30500	0
2/14/2003	MTDL	90	78500	0
2/17/2003	MTDL	90	21000	0
2/18/2003	MTDL	90	1431500	0
2/19/2003	MTDL	85	227000	-0.055555556
2/20/2003	MTDL	90	427500	0.058823529
2/21/2003	MTDL	90	83000	0
2/24/2003	MTDL	90	828500	0
2/25/2003	MTDL	80	824500	-0.111111111
2/26/2003	MTDL	85	11000	0.0625
2/27/2003	MTDL	85	1689500	0
2/28/2003	MTDL	85	857000	0
3/4/2003	MTDL	90	360500	0.058823529
3/5/2003	MTDL	85	497500	-0.055555556
3/6/2003	MTDL	85	80000	0
3/7/2003	MTDL	85	318000	0
3/9/2003	MTDL	110	23340000	0.294117647
3/10/2003	MTDL	85	166500	-0.227272727
3/11/2003	MTDL	80	214000	-0.058823529
3/12/2003	MTDL	80	497500	0
3/13/2003	MTDL	80	17500	0
3/14/2003	MTDL	80	172500	0
3/17/2003	MTDL	75	100000	-0.0625
3/18/2003	MTDL	80	2731000	0.066666667
3/19/2003	MTDL	80	83000	0
3/20/2003	MTDL	80	148000	0
3/21/2003	MTDL	85	1690500	0.0625
3/24/2003	MTDL	80	513500	-0.058823529
3/25/2003	MTDL	80	1500	0
3/26/2003	MTDL	80	1023000	0
3/27/2003	MTDL	85	828000	0.0625
3/28/2003	MTDL	80	405500	-0.058823529
3/31/2003	MTDL	75	159500	-0.0625
4/1/2003	MTDL	80	25000	0.066666667
4/3/2003	MTDL	80	2854000	0
4/4/2003	MTDL	80	1101000	0
4/7/2003	MTDL	90	12684500	0.125
4/8/2003	MTDL	85	2498000	-0.055555556

4/9/2003	MTDL	85	1050000	0
4/10/2003	MTDL	85	772500	0
4/11/2003	MTDL	90	10467500	0.058823529
4/14/2003	MTDL	90	1267500	0
4/15/2003	MTDL	85	750500	-0.055555556
4/16/2003	MTDL	100	5365500	0.176470588
4/17/2003	MTDL	115	26869500	0.15
4/21/2003	MTDL	115	19041500	0
4/22/2003	MTDL	105	5860000	-0.086956522
4/23/2003	MTDL	115	4391000	0.095238095
4/24/2003	MTDL	110	2409500	-0.043478261
4/25/2003	MTDL	110	4227500	0
4/28/2003	MTDL	100	1270000	-0.090909091
4/29/2003	MTDL	110	2882500	0.1
4/30/2003	MTDL	105	6798000	-0.045454545
5/1/2003	MTDL	110	2035000	0.047619048
5/2/2003	MTDL	115	7688000	0.045454545
5/5/2003	MTDL	115	7725000	0
5/6/2003	MTDL	115	9624500	0
5/7/2003	MTDL	120	17762000	0.043478261
5/8/2003	MTDL	115	3048500	-0.041666667
5/9/2003	MTDL	115	4305500	0
5/12/2003	MTDL	115	1306000	0
5/13/2003	MTDL	115	1708500	0
5/14/2003	MTDL	115	2072500	0
5/19/2003	MTDL	110	3007000	-0.043478261
5/20/2003	MTDL	105	1470000	-0.045454545
5/21/2003	MTDL	105	252500	0
5/22/2003	MTDL	110	109500	0.047619048
5/23/2003	MTDL	110	1577500	0
5/26/2003	MTDL	115	1058000	0.045454545
5/27/2003	MTDL	110	2276000	-0.043478261
5/28/2003	MTDL	125	29062000	0.136363636
5/29/2003	MTDL	120	18473500	-0.04
6/2/2003	MTDL	115	2941000	-0.041666667
6/3/2003	MTDL	120	2638000	0.043478261
6/4/2003	MTDL	120	9063000	0
6/5/2003	MTDL	130	31952500	0.083333333
6/6/2003	MTDL	130	5981000	0
6/9/2003	MTDL	135	31140000	0.038461538
6/10/2003	MTDL	135	8175000	0
6/11/2003	MTDL	125	9039000	-0.074074074
6/12/2003	MTDL	120	3884500	-0.04
6/13/2003	MTDL	130	509500	0.083333333
6/16/2003	MTDL	125	1021000	-0.038461538
6/17/2003	MTDL	120	3347000	-0.04
6/18/2003	MTDL	120	1304500	0
6/19/2003	MTDL	120	1064000	0
6/20/2003	MTDL	120	2282500	0
6/23/2003	MTDL	110	699000	-0.083333333

6/24/2003	MTDL	105	2230000	-0.045454545
6/25/2003	MTDL	110	455500	0.047619048
6/26/2003	MTDL	100	1777500	-0.090909091
6/27/2003	MTDL	110	1021000	0.1
6/30/2003	MTDL	110	1336500	0
7/1/2003	MTDL	110	1700500	0
7/2/2003	MTDL	110	1228500	0
7/3/2003	MTDL	115	5774500	0.045454545
7/4/2003	MTDL	110	457000	-0.043478261
7/7/2003	MTDL	115	352000	0.045454545
7/8/2003	MTDL	115	4551500	0
7/9/2003	MTDL	115	1866000	0
7/10/2003	MTDL	110	243000	-0.043478261
7/11/2003	MTDL	110	4715000	0
7/14/2003	MTDL	110	6857000	0
7/15/2003	MTDL	105	3285500	-0.045454545
7/16/2003	MTDL	105	216500	0
7/17/2003	MTDL	105	180500	0
7/18/2003	MTDL	110	275000	0.047619048
7/21/2003	MTDL	105	302500	-0.045454545
7/22/2003	MTDL	105	1391500	0
7/23/2003	MTDL	110	1689000	0.047619048
7/24/2003	MTDL	105	8062000	-0.045454545
7/25/2003	MTDL	105	3835500	0
7/28/2003	MTDL	105	1166000	0
7/29/2003	MTDL	105	88000	0
7/30/2003	MTDL	100	1675000	-0.047619048
7/31/2003	MTDL	100	182500	0
8/1/2003	MTDL	105	1710000	0.05
8/4/2003	MTDL	105	4378000	0
8/5/2003	MTDL	100	5836500	-0.047619048
8/6/2003	MTDL	100	975500	0
8/7/2003	MTDL	105	872500	0.05
8/8/2003	MTDL	105	3113000	0
8/9/2003	MTDL	105	2782500	0
8/11/2003	MTDL	100	9296500	-0.047619048
8/12/2003	MTDL	100	885500	0
8/13/2003	MTDL	95	1188000	-0.05
8/14/2003	MTDL	100	975500	0.052631579
8/15/2003	MTDL	95	25000	-0.05
8/19/2003	MTDL	100	15500	0.052631579
8/20/2003	MTDL	100	525000	0
8/21/2003	MTDL	100	2043500	0
8/22/2003	MTDL	100	3773000	0
8/25/2003	MTDL	105	6771000	0.05
8/26/2003	MTDL	105	3715500	0
8/27/2003	MTDL	105	7420000	0
8/28/2003	MTDL	105	5231000	0
8/29/2003	MTDL	105	182500	0
9/1/2003	MTDL	105	313500	0

9/2/2003	MTDL	105	400000	0
9/3/2003	MTDL	110	23340000	0.047619048
9/4/2003	MTDL	110	16567500	0
9/5/2003	MTDL	105	7054500	-0.045454545
9/8/2003	MTDL	105	2782500	0
9/9/2003	MTDL	105	2495500	0
9/10/2003	MTDL	105	527500	0
9/11/2003	MTDL	105	554000	0
9/12/2003	MTDL	105	440000	0
9/15/2003	MTDL	100	232500	-0.047619048
9/16/2003	MTDL	105	148000	0.05
9/17/2003	MTDL	110	3867500	0.047619048
9/18/2003	MTDL	105	939500	-0.045454545
9/19/2003	MTDL	105	1106000	0
9/23/2003	MTDL	100	760000	-0.047619048
9/24/2003	MTDL	105	1076000	0.05
9/25/2003	MTDL	105	15579500	0
9/26/2003	MTDL	105	3612000	0
9/29/2003	MTDL	100	1312500	-0.047619048
9/30/2003	MTDL	100	2140000	0
10/1/2003	MTDL	105	120000	0.05
10/2/2003	MTDL	105	2705500	0
10/3/2003	MTDL	100	6821000	-0.047619048
10/6/2003	MTDL	105	4755500	0.05
10/7/2003	MTDL	105	707500	0
10/8/2003	MTDL	105	7039500	0
10/9/2003	MTDL	105	3123500	0
10/10/2003	MTDL	105	4983500	0
10/13/2003	MTDL	105	1114000	0
10/14/2003	MTDL	105	6180000	0
10/15/2003	MTDL	110	4000000	0.047619048
10/16/2003	MTDL	110	18854500	0
10/17/2003	MTDL	105	10925500	-0.045454545
10/20/2003	MTDL	105	1963500	0
10/21/2003	MTDL	105	1904000	0
10/22/2003	MTDL	100	195000	-0.047619048
10/23/2003	MTDL	105	6237500	0.05
10/24/2003	MTDL	105	1177000	0
10/27/2003	MTDL	105	2205000	0
10/28/2003	MTDL	100	803000	-0.047619048
10/29/2003	MTDL	100	4171000	0
10/30/2003	MTDL	100	1726000	0
10/31/2003	MTDL	100	184000	0
11/3/2003	MTDL	95	4145000	-0.05
11/4/2003	MTDL	95	3122500	0
11/5/2003	MTDL	100	1724500	0.052631579
11/6/2003	MTDL	95	9758000	-0.05
11/7/2003	MTDL	100	950000	0.052631579
11/10/2003	MTDL	90	291500	-0.1
11/11/2003	MTDL	90	1523500	0

11/12/2003	MTDL	90	4200500	0
11/13/2003	MTDL	90	1280500	0
11/14/2003	MTDL	90	5000	0
11/17/2003	MTDL	90	1360000	0
11/18/2003	MTDL	90	790500	0
11/19/2003	MTDL	90	6000	0
11/20/2003	MTDL	85	110000	-0.055555556
11/21/2003	MTDL	95	3580000	0.117647059
12/1/2003	MTDL	90	211000	-0.052631579
12/2/2003	MTDL	95	549500	0.055555556
12/3/2003	MTDL	100	3779500	0.052631579
12/4/2003	MTDL	95	3102500	-0.05
12/5/2003	MTDL	90	193500	-0.052631579
12/8/2003	MTDL	95	1535000	0.055555556
12/9/2003	MTDL	90	118000	-0.052631579
12/10/2003	MTDL	95	3186500	0.055555556
12/11/2003	MTDL	95	901000	0
12/12/2003	MTDL	95	880500	0
12/15/2003	MTDL	90	254000	-0.052631579
12/16/2003	MTDL	90	25000	0
12/17/2003	MTDL	90	367500	0
12/18/2003	MTDL	90	5494000	0
12/19/2003	MTDL	85	405500	-0.055555556
12/22/2003	MTDL	90	275000	0.058823529
12/23/2003	MTDL	90	3424500	0
12/29/2003	MTDL	90	1737000	0
12/30/2003	MTDL	90	1553000	0

TELEKOMUNIKASI INDONESIA TBK

Date	Code	Closing price	Volume	Return
1/4/2000	TLKM	4350	34588000	0.094339622
1/5/2000	TLKM	4075	49340000	-0.063218391
1/6/2000	TLKM	4200	19251000	0.030674847
1/11/2000	TLKM	4275	34468500	0.017857143
1/12/2000	TLKM	4200	8519000	-0.01754386
1/13/2000	TLKM	4225	7768500	0.005952381
1/14/2000	TLKM	4300	16542500	0.017751479
1/17/2000	TLKM	4350	30939000	0.011627907
1/18/2000	TLKM	4275	11159500	-0.017241379
1/19/2000	TLKM	4000	45208500	-0.064327485
1/20/2000	TLKM	4100	20316500	0.025
1/21/2000	TLKM	4050	13578000	-0.012195122
1/24/2000	TLKM	3950	9986500	-0.024691358
1/26/2000	TLKM	3875	12835000	-0.018987342
1/27/2000	TLKM	3950	12552500	0.019354839
1/28/2000	TLKM	3875	9503000	-0.018987342
1/31/2000	TLKM	3825	9714500	-0.012903226
2/1/2000	TLKM	3675	24300000	-0.039215686
2/2/2000	TLKM	3650	16974500	-0.006802721
2/3/2000	TLKM	3650	24979500	0
2/4/2000	TLKM	3775	19052500	0.034246575
2/7/2000	TLKM	3850	18434500	0.01986755
2/8/2000	TLKM	3850	17202500	0
2/9/2000	TLKM	3950	19155000	0.025974026
2/10/2000	TLKM	4025	23844000	0.018987342
2/11/2000	TLKM	3900	22260500	-0.031055901
2/14/2000	TLKM	3825	23587500	-0.019230769
2/15/2000	TLKM	3850	10560500	0.006535948
2/16/2000	TLKM	3825	10871500	-0.006493506
2/17/2000	TLKM	3700	13848500	-0.032679739
2/18/2000	TLKM	3750	10865500	0.013513514
2/21/2000	TLKM	3725	13255500	-0.006666667
2/22/2000	TLKM	3625	16625000	-0.026845638
2/23/2000	TLKM	3700	10817000	0.020689655
2/24/2000	TLKM	3550	18380000	-0.040540541
2/25/2000	TLKM	3500	19722500	-0.014084507
2/28/2000	TLKM	3650	10124000	0.042857143
3/1/2000	TLKM	3525	38792500	-0.034246575
3/2/2000	TLKM	3325	32538500	-0.056737589
3/3/2000	TLKM	3400	19104000	0.022556391
3/6/2000	TLKM	3525	24656000	0.036764706
3/7/2000	TLKM	3475	14479500	-0.014184397
3/8/2000	TLKM	3475	9808000	0
3/9/2000	TLKM	3675	34690500	0.057553957
3/10/2000	TLKM	3700	30020500	0.006802721
3/13/2000	TLKM	3675	20959500	-0.006756757
3/14/2000	TLKM	3675	6671500	0

3/15/2000	TLKM	3700	13652000	0.006802721
3/17/2000	TLKM	3725	6854500	0.006756757
3/20/2000	TLKM	3625	3964000	-0.026845638
3/21/2000	TLKM	3650	4077000	0.006896552
3/22/2000	TLKM	3650	2449500	0
3/23/2000	TLKM	3625	5055000	-0.006849315
3/24/2000	TLKM	3600	2156500	-0.006896552
3/27/2000	TLKM	3625	4498500	0.006944444
3/28/2000	TLKM	3675	2862000	0.013793103
3/29/2000	TLKM	3700	17187000	0.006802721
3/30/2000	TLKM	3675	4002500	-0.006756757
4/3/2000	TLKM	3500	8915500	-0.047619048
4/5/2000	TLKM	3625	13038000	0.035714286
4/7/2000	TLKM	3725	19630000	0.027586207
4/10/2000	TLKM	3775	16925000	0.013422819
4/11/2000	TLKM	3675	15996500	-0.026490066
4/12/2000	TLKM	3625	18017500	-0.013605442
4/13/2000	TLKM	3625	11745500	0
4/14/2000	TLKM	3575	5369500	-0.013793103
4/17/2000	TLKM	3450	17807000	-0.034965035
4/18/2000	TLKM	3450	8843500	0
4/19/2000	TLKM	3425	5535500	-0.007246377
4/20/2000	TLKM	3425	4363500	0
4/24/2000	TLKM	3525	6652500	0.02919708
4/25/2000	TLKM	3450	5919000	-0.021276596
4/26/2000	TLKM	3525	12687000	0.02173913
4/27/2000	TLKM	3475	993500	-0.014184397
4/28/2000	TLKM	3450	3632500	-0.007194245
5/1/2000	TLKM	3450	624000	0
5/2/2000	TLKM	3475	3918500	0.007246377
5/3/2000	TLKM	3475	3865000	0
5/4/2000	TLKM	3450	3005000	-0.007194245
5/5/2000	TLKM	3475	6181000	0.007246377
5/8/2000	TLKM	3475	8751000	0
5/9/2000	TLKM	3500	5023500	0.007194245
5/10/2000	TLKM	3475	8632000	-0.007142857
5/11/2000	TLKM	3325	16439000	-0.043165468
5/12/2000	TLKM	3275	35680000	-0.015037594
5/15/2000	TLKM	3150	24588500	-0.038167939
5/16/2000	TLKM	2950	71229500	-0.063492063
5/17/2000	TLKM	3175	61044000	0.076271186
5/19/2000	TLKM	3075	13311000	-0.031496063
5/22/2000	TLKM	3000	10032000	-0.024390244
5/23/2000	TLKM	3050	10433500	0.016666667
5/24/2000	TLKM	3050	9615000	0
5/25/2000	TLKM	3025	6921500	-0.008196721
5/26/2000	TLKM	2975	8580500	-0.016528926
5/29/2000	TLKM	2850	15812500	-0.042016807
5/30/2000	TLKM	2950	21307500	0.035087719
5/31/2000	TLKM	2825	21894000	-0.042372881

6/2/2000	TLKM	2675	26471500	-0.053097345
6/5/2000	TLKM	2800	15689000	0.046728972
6/6/2000	TLKM	2750	7683000	-0.017857143
6/7/2000	TLKM	2825	17925500	0.027272727
6/8/2000	TLKM	3075	36659500	0.088495575
6/9/2000	TLKM	3050	34063000	-0.008130081
6/12/2000	TLKM	2975	24145500	-0.024590164
6/13/2000	TLKM	2800	21530000	-0.058823529
6/14/2000	TLKM	2975	24048500	0.0625
6/16/2000	TLKM	3075	14539500	0.033613445
6/19/2000	TLKM	3075	11311500	0
6/20/2000	TLKM	3050	8055000	-0.008130081
6/21/2000	TLKM	3100	19623000	0.016393443
6/22/2000	TLKM	3175	21065500	0.024193548
6/23/2000	TLKM	3125	9753000	-0.015748031
6/26/2000	TLKM	3125	4617000	0
6/27/2000	TLKM	3050	9856000	-0.024
6/28/2000	TLKM	3075	6266500	0.008196721
6/29/2000	TLKM	3075	6455000	0
6/30/2000	TLKM	3075	3827500	0
7/3/2000	TLKM	3045	4945000	-0.009756098
7/4/2000	TLKM	3135	8885500	0.02955665
7/5/2000	TLKM	3200	20129500	0.020733652
7/6/2000	TLKM	3235	8707500	0.0109375
7/7/2000	TLKM	3180	1380500	-0.017001546
7/10/2000	TLKM	3235	3485500	0.017295597
7/11/2000	TLKM	3230	1543000	-0.001545595
7/12/2000	TLKM	3230	3949000	0
7/13/2000	TLKM	3150	2607500	-0.024767802
7/14/2000	TLKM	3150	1390500	0
7/17/2000	TLKM	3200	2154500	0.015873016
7/18/2000	TLKM	3195	1586000	-0.0015625
7/19/2000	TLKM	3220	1897000	0.007824726
7/20/2000	TLKM	3325	12868500	0.032608696
7/21/2000	TLKM	3230	4683000	-0.028571429
7/24/2000	TLKM	3205	3421500	-0.007739938
7/25/2000	TLKM	3150	4125000	-0.017160686
7/26/2000	TLKM	3120	3564000	-0.00952381
7/27/2000	TLKM	3130	2656500	0.003205128
7/28/2000	TLKM	3125	2342000	-0.001597444
7/31/2000	TLKM	3065	3820000	-0.0192
8/1/2000	TLKM	3085	5733500	0.006525285
8/2/2000	TLKM	3100	3382500	0.004862237
8/3/2000	TLKM	3115	4685000	0.00483871
8/4/2000	TLKM	3115	3515500	0
8/7/2000	TLKM	3065	1931500	-0.016051364
8/8/2000	TLKM	3025	4488000	-0.013050571
8/9/2000	TLKM	3040	2987000	0.004958678
8/10/2000	TLKM	3060	9561500	0.006578947
8/11/2000	TLKM	3325	14526500	0.086601307

8/14/2000	TLKM	3245	14236000	-0.02406015
8/15/2000	TLKM	3275	7716000	0.009244992
8/16/2000	TLKM	3195	4585500	-0.024427481
8/18/2000	TLKM	3160	7842000	-0.010954617
8/21/2000	TLKM	3165	6836000	0.001582278
8/22/2000	TLKM	3140	6231000	-0.007898894
8/23/2000	TLKM	3170	6458000	0.00955414
8/24/2000	TLKM	3040	13924500	-0.041009464
8/25/2000	TLKM	3065	4081000	0.008223684
8/28/2000	TLKM	3030	4144500	-0.01141925
8/29/2000	TLKM	2980	6541500	-0.01650165
8/30/2000	TLKM	2955	4652500	-0.008389262
8/31/2000	TLKM	2890	11000000	-0.021996616
9/1/2000	TLKM	2980	4879000	0.031141869
9/4/2000	TLKM	3010	3774000	0.010067114
9/5/2000	TLKM	3030	4463000	0.006644518
9/6/2000	TLKM	3030	4268500	0
9/7/2000	TLKM	3035	3363000	0.001650165
9/8/2000	TLKM	3000	2339000	-0.011532125
9/11/2000	TLKM	2920	3915000	-0.026666667
9/12/2000	TLKM	2830	10017000	-0.030821918
9/13/2000	TLKM	2775	6630500	-0.019434629
9/18/2000	TLKM	2600	18181500	-0.063063063
9/19/2000	TLKM	2775	13321500	0.067307692
9/20/2000	TLKM	2725	9741000	-0.018018018
9/21/2000	TLKM	2730	5228500	0.001834862
9/22/2000	TLKM	2640	6468000	-0.032967033
9/25/2000	TLKM	2695	4361000	0.020833333
9/26/2000	TLKM	2740	3055000	0.016697588
9/27/2000	TLKM	2735	2181000	-0.001824818
9/28/2000	TLKM	2775	5935000	0.014625229
9/29/2000	TLKM	2780	13755000	0.001801802
10/2/2000	TLKM	2890	5771000	0.039568345
10/3/2000	TLKM	2795	6724000	-0.032871972
10/4/2000	TLKM	2735	5086000	-0.021466905
10/5/2000	TLKM	2760	3185500	0.009140768
10/6/2000	TLKM	2735	1008500	-0.009057971
10/9/2000	TLKM	2675	6083000	-0.021937843
10/10/2000	TLKM	2620	4662500	-0.020560748
10/11/2000	TLKM	2595	5493500	-0.009541985
10/12/2000	TLKM	2555	4103500	-0.015414258
10/13/2000	TLKM	2500	10950000	-0.021526419
10/16/2000	TLKM	2550	7336500	0.02
10/17/2000	TLKM	2550	5384500	0
10/18/2000	TLKM	2550	2761500	0
10/19/2000	TLKM	2470	11722500	-0.031372549
10/20/2000	TLKM	2475	7039500	0.002024291
10/23/2000	TLKM	2525	7792500	0.02020202
10/24/2000	TLKM	2525	2213500	0
10/26/2000	TLKM	2475	2956500	-0.01980198

10/27/2000	TLKM	2450	5761500	-0.01010101
10/30/2000	TLKM	2325	13605500	-0.051020408
10/31/2000	TLKM	2400	9909000	0.032258065
11/1/2000	TLKM	2400	8659000	0
11/2/2000	TLKM	2350	4738500	-0.020833333
11/3/2000	TLKM	2350	5285000	0
11/6/2000	TLKM	2425	8344500	0.031914894
11/7/2000	TLKM	2450	18520500	0.010309278
11/8/2000	TLKM	2550	37168000	0.040816327
11/9/2000	TLKM	2500	16055500	-0.019607843
11/10/2000	TLKM	2575	22737000	0.03
11/13/2000	TLKM	2500	14120000	-0.029126214
11/14/2000	TLKM	2425	11827500	-0.03
11/15/2000	TLKM	2325	19291000	-0.041237113
11/16/2000	TLKM	2325	14142000	0
11/17/2000	TLKM	2325	18532500	0
11/20/2000	TLKM	2425	26299500	0.043010753
11/21/2000	TLKM	2400	15353000	-0.010309278
11/22/2000	TLKM	2425	17438000	0.010416667
11/23/2000	TLKM	2525	33314500	0.041237113
11/24/2000	TLKM	2475	15004500	-0.01980198
11/27/2000	TLKM	2425	12690000	-0.02020202
11/28/2000	TLKM	2400	6231000	-0.010309278
11/29/2000	TLKM	2375	6992500	-0.010416667
11/30/2000	TLKM	2450	11376000	0.031578947
12/1/2000	TLKM	2400	11432000	-0.020408163
12/4/2000	TLKM	2375	8379500	-0.010416667
12/5/2000	TLKM	2375	4488500	0
12/6/2000	TLKM	2425	16637000	0.021052632
12/7/2000	TLKM	2375	2608500	-0.020618557
12/8/2000	TLKM	2350	12539000	-0.010526316
12/11/2000	TLKM	2250	43768500	-0.042553191
12/12/2000	TLKM	2225	13714500	-0.011111111
12/13/2000	TLKM	2250	8036000	0.011235955
12/14/2000	TLKM	2150	18536500	-0.044444444
12/15/2000	TLKM	2125	26559000	-0.011627907
12/18/2000	TLKM	2100	4271000	-0.011764706
12/19/2000	TLKM	2125	3617000	0.011904762
12/20/2000	TLKM	2100	5571500	-0.011764706
12/21/2000	TLKM	2025	12003500	-0.035714286
12/22/2000	TLKM	2050	7374500	0.012345679
1/2/2001	TLKM	1950	8167500	-0.048780488
1/3/2001	TLKM	1825	27554500	-0.064102564
1/4/2001	TLKM	1950	33200000	0.068493151
1/5/2001	TLKM	2150	45253000	0.102564103
1/8/2001	TLKM	2200	32922500	0.023255814
1/9/2001	TLKM	2200	35946500	0
1/10/2001	TLKM	2325	43484000	0.056818182
1/11/2001	TLKM	2250	21427000	-0.032258065
1/12/2001	TLKM	2250	7625000	0

1/15/2001	TLKM	2300	19099500	0.022222222
1/16/2001	TLKM	2350	16039500	0.02173913
1/17/2001	TLKM	2325	28317500	-0.010638298
1/18/2001	TLKM	2400	29791000	0.032258065
1/19/2001	TLKM	2375	14031000	-0.010416667
1/22/2001	TLKM	2475	26464000	0.042105263
1/23/2001	TLKM	2425	7336500	-0.02020202
1/24/2001	TLKM	2450	4933000	0.010309278
1/25/2001	TLKM	2450	5734500	0
1/26/2001	TLKM	2425	4193000	-0.010204082
1/29/2001	TLKM	2375	14479500	-0.020618557
1/30/2001	TLKM	2375	4349000	0
1/31/2001	TLKM	2525	44007000	0.063157895
2/1/2001	TLKM	2600	72181500	0.02970297
2/2/2001	TLKM	2850	109464500	0.096153846
2/5/2001	TLKM	3000	104275500	0.052631579
2/6/2001	TLKM	2875	32022000	-0.041666667
2/7/2001	TLKM	2850	40932500	-0.008695652
2/8/2001	TLKM	2875	23970000	0.00877193
2/9/2001	TLKM	2750	31347500	-0.043478261
2/12/2001	TLKM	2775	19962000	0.009090909
2/13/2001	TLKM	2725	12185500	-0.018018018
2/14/2001	TLKM	2725	6705500	0
2/15/2001	TLKM	3100	121829500	0.137614679
2/16/2001	TLKM	2925	64735500	-0.056451613
2/19/2001	TLKM	3000	30155500	0.025641026
2/20/2001	TLKM	3025	15931500	0.008333333
2/21/2001	TLKM	3125	48334000	0.033057851
2/22/2001	TLKM	3100	19422500	-0.008
2/23/2001	TLKM	3075	7557500	-0.008064516
2/26/2001	TLKM	3000	18254500	-0.024390244
2/27/2001	TLKM	2975	12724000	-0.008333333
2/28/2001	TLKM	2925	13853000	-0.016806723
3/1/2001	TLKM	2925	16726500	0
3/2/2001	TLKM	2925	14669000	0
3/6/2001	TLKM	2950	7683500	0.008547009
3/7/2001	TLKM	2975	14022000	0.008474576
3/8/2001	TLKM	2925	3717500	-0.016806723
3/9/2001	TLKM	2775	17593000	-0.051282051
3/12/2001	TLKM	2675	31578000	-0.036036036
3/13/2001	TLKM	2575	23852000	-0.037383178
3/14/2001	TLKM	2575	23254500	0
3/15/2001	TLKM	2550	16927500	-0.009708738
3/16/2001	TLKM	2475	11926500	-0.029411765
3/19/2001	TLKM	2325	25097000	-0.060606061
3/20/2001	TLKM	2250	23565500	-0.032258065
3/21/2001	TLKM	2350	69954000	0.044444444
3/22/2001	TLKM	2200	29351500	-0.063829787
3/23/2001	TLKM	2275	27320000	0.034090909
3/27/2001	TLKM	2275	20316000	0

3/28/2001	TLKM	2325	18504000	0.021978022
3/29/2001	TLKM	2425	31159000	0.043010753
3/30/2001	TLKM	2425	39755000	0
4/2/2001	TLKM	2300	13034000	-0.051546392
4/3/2001	TLKM	2300	25951500	0
4/4/2001	TLKM	2250	13551500	-0.02173913
4/5/2001	TLKM	2275	19939500	0.011111111
4/6/2001	TLKM	2275	19433500	0
4/9/2001	TLKM	2250	8027000	-0.010989011
4/10/2001	TLKM	2350	18039000	0.044444444
4/11/2001	TLKM	2350	23766500	0
4/12/2001	TLKM	2325	3592500	-0.010638298
4/16/2001	TLKM	2300	3931500	-0.010752688
4/17/2001	TLKM	2275	3482500	-0.010869565
4/18/2001	TLKM	2300	9649000	0.010989011
4/19/2001	TLKM	2275	23201000	-0.010869565
4/20/2001	TLKM	2225	22095000	-0.021978022
4/23/2001	TLKM	2250	15909000	0.011235955
4/24/2001	TLKM	2275	7131000	0.011111111
4/25/2001	TLKM	2350	23477500	0.032967033
4/26/2001	TLKM	2300	16815500	-0.021276596
4/27/2001	TLKM	2300	38073500	0
4/30/2001	TLKM	2400	21951500	0.043478261
5/1/2001	TLKM	2375	47794500	-0.010416667
5/2/2001	TLKM	2400	12710000	0.010526316
5/3/2001	TLKM	2500	40422000	0.041666667
5/4/2001	TLKM	2500	30419500	0
5/8/2001	TLKM	2500	19204000	0
5/9/2001	TLKM	2475	21705500	-0.01
5/10/2001	TLKM	2425	32048500	-0.02020202
5/11/2001	TLKM	2475	12294000	0.020618557
5/14/2001	TLKM	2425	7994500	-0.02020202
5/15/2001	TLKM	2475	6448000	0.020618557
5/16/2001	TLKM	2500	15438000	0.01010101
5/17/2001	TLKM	2525	29642500	0.01
5/18/2001	TLKM	2575	19417000	0.01980198
5/21/2001	TLKM	2650	30952000	0.029126214
5/22/2001	TLKM	2650	13114500	0
5/23/2001	TLKM	2650	11893500	0
5/25/2001	TLKM	2825	45959500	0.066037736
5/28/2001	TLKM	2900	81135000	0.026548673
5/29/2001	TLKM	3000	66271000	0.034482759
5/30/2001	TLKM	3025	47202500	0.008333333
5/31/2001	TLKM	3000	23122000	-0.008264463
6/1/2001	TLKM	2875	22084000	-0.041666667
6/5/2001	TLKM	2825	26500000	-0.017391304
6/6/2001	TLKM	2825	11731000	0
6/7/2001	TLKM	2775	10155000	-0.017699115
6/8/2001	TLKM	2825	5004000	0.018018018
6/11/2001	TLKM	2925	9604500	0.03539823

6/12/2001	TLKM	3025	29860000	0.034188034
6/13/2001	TLKM	3000	12972500	-0.008264463
6/14/2001	TLKM	2950	12989500	-0.016666667
6/15/2001	TLKM	2950	6764000	0
6/18/2001	TLKM	2975	2908500	0.008474576
6/19/2001	TLKM	3000	9879500	0.008403361
6/20/2001	TLKM	3100	21611000	0.033333333
6/21/2001	TLKM	3175	51732000	0.024193548
6/22/2001	TLKM	3200	12117000	0.007874016
6/25/2001	TLKM	3125	22725500	-0.0234375
6/26/2001	TLKM	3125	8867000	0
6/27/2001	TLKM	3150	13803000	0.008
6/28/2001	TLKM	3125	19281500	-0.007936508
6/29/2001	TLKM	3200	14129500	0.024
7/2/2001	TLKM	3150	3973000	-0.015625
7/3/2001	TLKM	3125	13766000	-0.007936508
7/4/2001	TLKM	3150	6361500	0.008
7/5/2001	TLKM	3175	9826000	0.007936508
7/6/2001	TLKM	3175	1447000	0
7/9/2001	TLKM	3150	2344500	-0.007874016
7/10/2001	TLKM	3200	25336500	0.015873016
7/11/2001	TLKM	3200	4492000	0
7/12/2001	TLKM	3200	9430500	0
7/13/2001	TLKM	3275	38153000	0.0234375
7/16/2001	TLKM	3175	16118500	-0.030534351
7/17/2001	TLKM	3225	10332000	0.015748031
7/18/2001	TLKM	3300	6337000	0.023255814
7/19/2001	TLKM	3375	23001000	0.022727273
7/20/2001	TLKM	3325	21284000	-0.014814815
7/23/2001	TLKM	3400	52177500	0.022556391
7/24/2001	TLKM	3200	104795000	-0.058823529
7/25/2001	TLKM	3025	86366500	-0.0546875
7/26/2001	TLKM	2950	40046500	-0.024793388
7/27/2001	TLKM	3050	52341000	0.033898305
7/30/2001	TLKM	3000	26124500	-0.016393443
7/31/2001	TLKM	2975	30585500	-0.008333333
8/1/2001	TLKM	2925	16395000	-0.016806723
8/2/2001	TLKM	2875	14335000	-0.017094017
8/3/2001	TLKM	2900	9476000	0.008695652
8/6/2001	TLKM	2825	10674000	-0.025862069
8/7/2001	TLKM	2825	22086500	0
8/8/2001	TLKM	2925	41289500	0.03539823
8/9/2001	TLKM	2825	80186500	-0.034188034
8/10/2001	TLKM	2875	20839500	0.017699115
8/13/2001	TLKM	2950	58085000	0.026086957
8/14/2001	TLKM	3000	34378500	0.016949153
8/15/2001	TLKM	2950	25068500	-0.016666667
8/16/2001	TLKM	2975	12712500	0.008474576
8/20/2001	TLKM	2950	24200500	-0.008403361
8/21/2001	TLKM	2975	20394500	0.008474576

8/22/2001	TLKM	3075	27595500	0.033613445
8/23/2001	TLKM	3050	20773500	-0.008130081
8/24/2001	TLKM	3075	15292500	0.008196721
8/27/2001	TLKM	3125	25084500	0.016260163
8/28/2001	TLKM	3075	8972000	-0.016
8/29/2001	TLKM	3000	8752500	-0.024390244
8/30/2001	TLKM	3000	6820000	0
8/31/2001	TLKM	2950	9111000	-0.016666667
9/3/2001	TLKM	2950	8015500	0
9/4/2001	TLKM	3100	32748000	0.050847458
9/5/2001	TLKM	3150	35117000	0.016129032
9/6/2001	TLKM	3225	49276500	0.023809524
9/7/2001	TLKM	3200	51870500	-0.007751938
9/10/2001	TLKM	3175	7111500	-0.0078125
9/11/2001	TLKM	3250	29122500	0.023622047
9/12/2001	TLKM	3025	72836000	-0.069230769
9/13/2001	TLKM	3150	34752000	0.041322314
9/14/2001	TLKM	3150	38047500	0
9/17/2001	TLKM	2975	28896000	-0.055555556
9/18/2001	TLKM	3000	29280000	0.008403361
9/19/2001	TLKM	3075	30882000	0.025
9/20/2001	TLKM	3075	18823000	0
9/21/2001	TLKM	2975	20870500	-0.032520325
9/24/2001	TLKM	2975	11008500	0
9/25/2001	TLKM	2975	24928000	0
9/26/2001	TLKM	2875	30851500	-0.033613445
9/27/2001	TLKM	2775	18373500	-0.034782609
9/28/2001	TLKM	2650	39104000	-0.045045045
10/1/2001	TLKM	2650	18790500	0
10/2/2001	TLKM	2525	36900000	-0.047169811
10/3/2001	TLKM	2450	54753000	-0.02970297
10/4/2001	TLKM	2575	42171000	0.051020408
10/5/2001	TLKM	2575	16894500	0
10/8/2001	TLKM	2425	40589000	-0.058252427
10/9/2001	TLKM	2450	32110500	0.010309278
10/10/2001	TLKM	2475	15581000	0.010204082
10/11/2001	TLKM	2525	20448500	0.02020202
10/12/2001	TLKM	2750	60505500	0.089108911
10/16/2001	TLKM	2825	28836500	0.027272727
10/17/2001	TLKM	2850	22303500	0.008849558
10/18/2001	TLKM	2900	12538000	0.01754386
10/19/2001	TLKM	2850	9088500	-0.017241379
10/22/2001	TLKM	2925	16933500	0.026315789
10/23/2001	TLKM	2925	11814500	0
10/24/2001	TLKM	2825	11805000	-0.034188034
10/25/2001	TLKM	2875	5045500	0.017699115
10/26/2001	TLKM	2800	13238000	-0.026086957
10/29/2001	TLKM	2775	9441500	-0.008928571
10/30/2001	TLKM	2625	32810000	-0.054054054
10/31/2001	TLKM	2825	82064500	0.076190476

11/1/2001	TLKM	2800	32242500	-0.008849558
11/2/2001	TLKM	2825	34068000	0.008928571
11/5/2001	TLKM	2675	37989000	-0.053097345
11/6/2001	TLKM	2700	26341500	0.009345794
11/7/2001	TLKM	2800	27169000	0.037037037
11/8/2001	TLKM	3000	63305500	0.071428571
11/9/2001	TLKM	2900	24285500	-0.033333333
11/12/2001	TLKM	2825	20697500	-0.025862069
11/13/2001	TLKM	2825	17891500	0
11/14/2001	TLKM	2850	30813500	0.008849558
11/15/2001	TLKM	2850	14565000	0
11/16/2001	TLKM	2850	21212500	0
11/19/2001	TLKM	2800	20942500	-0.01754386
11/20/2001	TLKM	2750	42561500	-0.017857143
11/21/2001	TLKM	2750	9523500	0
11/22/2001	TLKM	2750	8512500	0
11/23/2001	TLKM	2750	8952500	0
11/26/2001	TLKM	2750	11096000	0
11/27/2001	TLKM	2775	13056500	0.009090909
11/28/2001	TLKM	2775	14126500	0
11/29/2001	TLKM	2750	11359000	-0.009009009
11/30/2001	TLKM	2750	7218000	0
12/3/2001	TLKM	2750	3655000	0
12/4/2001	TLKM	2700	16648000	-0.018181818
12/5/2001	TLKM	2700	11715500	0
12/6/2001	TLKM	2700	23836000	0
12/7/2001	TLKM	2700	20775500	0
12/10/2001	TLKM	2625	44611500	-0.027777778
12/11/2001	TLKM	2600	66711500	-0.00952381
12/12/2001	TLKM	2625	8059500	0.009615385
12/13/2001	TLKM	2750	17407500	0.047619048
12/19/2001	TLKM	2775	21901000	0.009090909
12/20/2001	TLKM	2825	20124000	0.018018018
12/21/2001	TLKM	2825	15304000	0
12/26/2001	TLKM	2800	2006500	-0.008849558
12/27/2001	TLKM	2850	9233000	0.017857143
12/28/2001	TLKM	3200	92524500	0.122807018
1/2/2002	TLKM	2900	35658500	-0.09375
1/3/2002	TLKM	2825	16563500	-0.025862069
1/4/2002	TLKM	2875	29451000	0.017699115
1/7/2002	TLKM	2950	15260500	0.026086957
1/8/2002	TLKM	2950	26351500	0
1/9/2002	TLKM	3000	28482500	0.016949153
1/10/2002	TLKM	3100	27893000	0.033333333
1/11/2002	TLKM	3175	87119500	0.024193548
1/14/2002	TLKM	3250	37905500	0.023622047
1/15/2002	TLKM	3325	50264000	0.023076923
1/16/2002	TLKM	3325	51022000	0
1/17/2002	TLKM	3225	26967000	-0.030075188
1/18/2002	TLKM	3250	21324000	0.007751938

1/21/2002	TLKM	3225	24068500	-0.007692308
1/22/2002	TLKM	3275	9984500	0.015503876
1/23/2002	TLKM	3425	21262000	0.045801527
1/24/2002	TLKM	3650	70776500	0.065693431
1/25/2002	TLKM	3650	19384000	0
1/28/2002	TLKM	3500	15860500	-0.04109589
1/29/2002	TLKM	3550	6937000	0.014285714
1/30/2002	TLKM	3575	8963000	0.007042254
1/31/2002	TLKM	3700	19431500	0.034965035
2/1/2002	TLKM	3725	15613000	0.006756757
2/4/2002	TLKM	3650	4456500	-0.020134228
2/5/2002	TLKM	3600	13061500	-0.01369863
2/6/2002	TLKM	3550	21600500	-0.013888889
2/7/2002	TLKM	3375	36923000	-0.049295775
2/8/2002	TLKM	3450	23445000	0.022222222
2/11/2002	TLKM	3475	7772500	0.007246377
2/13/2002	TLKM	3425	2080500	-0.014388489
2/14/2002	TLKM	3475	8545500	0.01459854
2/15/2002	TLKM	3600	16269500	0.035971223
2/18/2002	TLKM	3800	27267000	0.055555556
2/19/2002	TLKM	3775	48162500	-0.006578947
2/20/2002	TLKM	3650	19488500	-0.033112583
2/21/2002	TLKM	3700	12839000	0.01369863
2/25/2002	TLKM	3500	40499500	-0.054054054
2/26/2002	TLKM	3500	23039000	0
2/27/2002	TLKM	3625	21644500	0.035714286
2/28/2002	TLKM	3625	16470000	0
3/1/2002	TLKM	3600	4467000	-0.006896552
3/4/2002	TLKM	3625	7779000	0.006944444
3/5/2002	TLKM	3675	6164500	0.013793103
3/6/2002	TLKM	4250	48294500	0.156462585
3/7/2002	TLKM	3900	15489000	-0.082352941
3/8/2002	TLKM	3975	15902000	0.019230769
3/11/2002	TLKM	3950	15532500	-0.006289308
3/12/2002	TLKM	3950	8217000	0
3/13/2002	TLKM	3950	8385000	0
3/14/2002	TLKM	3875	10591500	-0.018987342
3/18/2002	TLKM	3925	9280000	0.012903226
3/19/2002	TLKM	3900	3141000	-0.006369427
3/20/2002	TLKM	3900	12672500	0
3/21/2002	TLKM	3975	39790500	0.019230769
3/22/2002	TLKM	4150	43367500	0.044025157
3/25/2002	TLKM	4025	16382000	-0.030120482
3/26/2002	TLKM	4075	30334500	0.01242236
3/27/2002	TLKM	4125	10841000	0.012269939
3/28/2002	TLKM	4075	48655500	-0.012121212
4/1/2002	TLKM	4175	19658000	0.024539877
4/2/2002	TLKM	4250	31297500	0.017964072
4/3/2002	TLKM	4300	15858000	0.011764706
4/4/2002	TLKM	4700	47416500	0.093023256

4/5/2002	TLKM	4675	29139000	-0.005319149
4/8/2002	TLKM	4500	35333500	-0.037433155
4/9/2002	TLKM	4550	9270500	0.011111111
4/10/2002	TLKM	4550	18554000	0
4/11/2002	TLKM	4475	30406500	-0.016483516
4/12/2002	TLKM	4475	11798500	0
4/15/2002	TLKM	4525	14089000	0.011173184
4/16/2002	TLKM	4475	8827000	-0.011049724
4/17/2002	TLKM	4250	36615500	-0.05027933
4/18/2002	TLKM	4225	19562000	-0.005882353
4/19/2002	TLKM	4175	25978500	-0.01183432
4/22/2002	TLKM	4050	20467500	-0.02994012
4/23/2002	TLKM	4250	29382000	0.049382716
4/24/2002	TLKM	4325	31187000	0.017647059
4/25/2002	TLKM	4300	9541500	-0.005780347
4/26/2002	TLKM	4200	12568000	-0.023255814
4/29/2002	TLKM	4025	18608000	-0.041666667
4/30/2002	TLKM	4200	36150500	0.043478261
5/1/2002	TLKM	4275	24054500	0.017857143
5/2/2002	TLKM	4300	19655000	0.005847953
5/3/2002	TLKM	4275	8722000	-0.005813953
5/6/2002	TLKM	4225	6353000	-0.011695906
5/7/2002	TLKM	4300	11126500	0.017751479
5/8/2002	TLKM	4375	23916000	0.01744186
5/10/2002	TLKM	4275	18156500	-0.022857143
5/13/2002	TLKM	4150	17462000	-0.029239766
5/14/2002	TLKM	4200	14191500	0.012048193
5/15/2002	TLKM	4200	9507500	0
5/16/2002	TLKM	4075	26248000	-0.029761905
5/17/2002	TLKM	4050	15846500	-0.006134969
5/20/2002	TLKM	4075	13546500	0.00617284
5/21/2002	TLKM	4050	5171500	-0.006134969
5/22/2002	TLKM	3925	43709000	-0.030864198
5/23/2002	TLKM	3825	21808500	-0.025477707
5/24/2002	TLKM	3850	8692500	0.006535948
5/27/2002	TLKM	3950	13304500	0.025974026
5/28/2002	TLKM	3925	11012500	-0.006329114
5/29/2002	TLKM	3950	4390000	0.006369427
5/30/2002	TLKM	3950	8977000	0
5/31/2002	TLKM	4075	30161500	0.03164557
6/3/2002	TLKM	4000	8652500	-0.018404908
6/4/2002	TLKM	3925	5893500	-0.01875
6/5/2002	TLKM	4000	27377000	0.01910828
6/6/2002	TLKM	3950	18735500	-0.0125
6/7/2002	TLKM	3950	4271000	0
6/10/2002	TLKM	3950	3748000	0
6/11/2002	TLKM	4000	10135500	0.012658228
6/12/2002	TLKM	4000	12689000	0
6/13/2002	TLKM	4125	42548000	0.03125
6/14/2002	TLKM	4275	46544500	0.036363636

6/17/2002	TLKM	4300	24574500	0.005847953
6/18/2002	TLKM	4250	14725000	-0.011627907
6/19/2002	TLKM	4200	11777500	-0.011764706
6/20/2002	TLKM	4125	11703500	-0.017857143
6/21/2002	TLKM	4075	13771000	-0.012121212
6/24/2002	TLKM	3900	29524500	-0.042944785
6/25/2002	TLKM	3850	25845000	-0.012820513
6/26/2002	TLKM	3775	29610000	-0.019480519
6/27/2002	TLKM	3775	38949500	0
6/28/2002	TLKM	3750	19992000	-0.006622517
7/1/2002	TLKM	3675	20619500	-0.02
7/2/2002	TLKM	3575	50190000	-0.027210884
7/3/2002	TLKM	3575	22673500	0
7/4/2002	TLKM	3750	40866000	0.048951049
7/5/2002	TLKM	3750	22445000	0
7/8/2002	TLKM	3600	21915000	-0.04
7/9/2002	TLKM	3625	10101000	0.006944444
7/10/2002	TLKM	3625	13458000	0
7/11/2002	TLKM	3550	13453500	-0.020689655
7/12/2002	TLKM	3700	21394500	0.042253521
7/15/2002	TLKM	3750	29170500	0.013513514
7/16/2002	TLKM	3775	26592000	0.006666667
7/17/2002	TLKM	3700	17119500	-0.01986755
7/18/2002	TLKM	3850	30223000	0.040540541
7/19/2002	TLKM	3850	20801000	0
7/22/2002	TLKM	3750	16591000	-0.025974026
7/23/2002	TLKM	3775	15184000	0.006666667
7/24/2002	TLKM	3675	18198000	-0.026490066
7/25/2002	TLKM	3425	23005500	-0.068027211
7/26/2002	TLKM	3325	12842500	-0.02919708
7/29/2002	TLKM	3575	19741500	0.07518797
7/30/2002	TLKM	3650	21798500	0.020979021
7/31/2002	TLKM	3675	18626500	0.006849315
8/1/2002	TLKM	3750	23369000	0.020408163
8/2/2002	TLKM	3650	9498000	-0.026666667
8/5/2002	TLKM	3600	14317000	-0.01369863
8/6/2002	TLKM	3525	17628500	-0.020833333
8/7/2002	TLKM	3575	9245000	0.014184397
8/8/2002	TLKM	3600	14150500	0.006993007
8/9/2002	TLKM	3725	12081500	0.034722222
8/12/2002	TLKM	3725	4423000	0
8/13/2002	TLKM	3725	5536000	0
8/14/2002	TLKM	3650	5381500	-0.020134228
8/15/2002	TLKM	3625	16004500	-0.006849315
8/16/2002	TLKM	3675	17596000	0.013793103
8/19/2002	TLKM	3675	16702000	0
8/20/2002	TLKM	3725	8253000	0.013605442
8/21/2002	TLKM	3725	6285000	0
8/22/2002	TLKM	3750	14709000	0.006711409
8/23/2002	TLKM	3775	10624500	0.006666667

8/26/2002	TLKM	3750	5137000	-0.006622517
8/27/2002	TLKM	3750	4924000	0
8/28/2002	TLKM	3675	9532500	-0.02
8/29/2002	TLKM	3600	14307000	-0.020408163
8/30/2002	TLKM	3625	5670500	0.006944444
9/2/2002	TLKM	3550	4101500	-0.020689655
9/3/2002	TLKM	3350	25238000	-0.056338028
9/4/2002	TLKM	3175	34175000	-0.052238806
9/5/2002	TLKM	3350	38036000	0.05511811
9/6/2002	TLKM	3425	28332500	0.02238806
9/9/2002	TLKM	3500	9261500	0.02189781
9/10/2002	TLKM	3600	20973000	0.028571429
9/11/2002	TLKM	3550	6024500	-0.013888889
9/12/2002	TLKM	3475	5087500	-0.021126761
9/13/2002	TLKM	3325	8982500	-0.043165468
9/16/2002	TLKM	3375	7712500	0.015037594
9/17/2002	TLKM	3500	18785500	0.037037037
9/18/2002	TLKM	3325	17169000	-0.05
9/19/2002	TLKM	3275	21909000	-0.015037594
9/20/2002	TLKM	3350	10958000	0.022900763
9/23/2002	TLKM	3325	1699000	-0.007462687
9/24/2002	TLKM	3300	4284000	-0.007518797
9/25/2002	TLKM	3300	8953000	0
9/26/2002	TLKM	3350	14865500	0.015151515
9/27/2002	TLKM	3350	6554000	0
9/30/2002	TLKM	3725	33334500	0.111940299
10/1/2002	TLKM	3325	15057000	-0.10738255
10/2/2002	TLKM	3300	15649500	-0.007518797
10/3/2002	TLKM	3325	9630500	0.007575758
10/7/2002	TLKM	3275	16943000	-0.015037594
10/8/2002	TLKM	3325	7128000	0.015267176
10/9/2002	TLKM	3200	15612500	-0.037593985
10/10/2002	TLKM	3175	16199500	-0.0078125
10/11/2002	TLKM	2975	12809000	-0.062992126
10/14/2002	TLKM	2400	118147500	-0.193277311
10/15/2002	TLKM	2575	128482000	0.072916667
10/16/2002	TLKM	2775	91390500	0.077669903
10/17/2002	TLKM	2825	40758500	0.018018018
10/18/2002	TLKM	2850	29262500	0.008849558
10/21/2002	TLKM	2825	22310500	-0.00877193
10/22/2002	TLKM	2725	36209000	-0.03539823
10/23/2002	TLKM	2700	33332500	-0.009174312
10/24/2002	TLKM	2725	9991000	0.009259259
10/25/2002	TLKM	2675	19072500	-0.018348624
10/28/2002	TLKM	2750	27445000	0.028037383
10/29/2002	TLKM	2825	37635500	0.027272727
10/30/2002	TLKM	2875	12488500	0.017699115
10/31/2002	TLKM	3075	63113000	0.069565217
11/1/2002	TLKM	3050	23663500	-0.008130081
11/4/2002	TLKM	3225	17205500	0.057377049

11/5/2002	TLKM	3100	29149000	-0.03875969
11/6/2002	TLKM	3050	20870000	-0.016129032
11/7/2002	TLKM	3050	6445500	0
11/8/2002	TLKM	3100	21808500	0.016393443
11/11/2002	TLKM	3100	8457500	0
11/12/2002	TLKM	3250	24811000	0.048387097
11/13/2002	TLKM	3225	16911500	-0.007692308
11/14/2002	TLKM	3325	29259500	0.031007752
11/15/2002	TLKM	3250	11881000	-0.022556391
11/18/2002	TLKM	3175	9936000	-0.023076923
11/19/2002	TLKM	3175	7003000	0
11/20/2002	TLKM	3225	8857000	0.015748031
11/21/2002	TLKM	3275	5601000	0.015503876
11/22/2002	TLKM	3350	15796000	0.022900763
11/25/2002	TLKM	3350	15036500	0
11/26/2002	TLKM	3325	14854000	-0.007462687
11/27/2002	TLKM	3325	12446000	0
11/28/2002	TLKM	3500	46084000	0.052631579
11/29/2002	TLKM	3550	21069500	0.014285714
12/2/2002	TLKM	3500	10108500	-0.014084507
12/3/2002	TLKM	3600	24572500	0.028571429
12/4/2002	TLKM	3675	17811500	0.020833333
12/11/2002	TLKM	3550	34996500	-0.034013605
12/12/2002	TLKM	3625	18867000	0.021126761
12/13/2002	TLKM	3625	10286000	0
12/16/2002	TLKM	3750	31701000	0.034482759
12/17/2002	TLKM	3775	27015500	0.006666667
12/18/2002	TLKM	3750	11998500	-0.006622517
12/19/2002	TLKM	3875	39411500	0.033333333
12/20/2002	TLKM	3950	23050000	0.019354839
12/23/2002	TLKM	3925	11165500	-0.006329114
12/27/2002	TLKM	3850	18874000	-0.01910828
1/2/2003	TLKM	3725	12548000	-0.032467532
1/3/2003	TLKM	3725	10571500	0
1/6/2003	TLKM	3550	32088500	-0.046979866
1/7/2003	TLKM	3500	24097500	-0.014084507
1/8/2003	TLKM	3525	12220000	0.007142857
1/9/2003	TLKM	3600	25990500	0.021276596
1/10/2003	TLKM	3600	10767500	0
1/13/2003	TLKM	3600	6491500	0
1/14/2003	TLKM	3700	17641000	0.027777778
1/15/2003	TLKM	3625	21221000	-0.02027027
1/16/2003	TLKM	3375	106606000	-0.068965517
1/17/2003	TLKM	3475	33895000	0.02962963
1/20/2003	TLKM	3500	26870500	0.007194245
1/21/2003	TLKM	3550	11207500	0.014285714
1/22/2003	TLKM	3525	19985500	-0.007042254
1/23/2003	TLKM	3550	15025500	0.007092199
1/24/2003	TLKM	3500	7657000	-0.014084507
1/27/2003	TLKM	3350	11948500	-0.042857143

1/28/2003	TLKM	3400	17284000	0.014925373
1/29/2003	TLKM	3375	16090500	-0.007352941
1/30/2003	TLKM	3425	12469500	0.014814815
1/31/2003	TLKM	3375	7501500	-0.01459854
2/3/2003	TLKM	3400	4131500	0.007407407
2/4/2003	TLKM	3425	9218500	0.007352941
2/5/2003	TLKM	3325	18296000	-0.02919708
2/6/2003	TLKM	3350	10935000	0.007518797
2/7/2003	TLKM	3400	13493500	0.014925373
2/9/2003	TLKM	4600	8887500	0.352941176
2/10/2003	TLKM	3475	18088500	-0.244565217
2/11/2003	TLKM	3400	11689000	-0.021582734
2/13/2003	TLKM	3450	16074000	0.014705882
2/14/2003	TLKM	3575	31282500	0.036231884
2/17/2003	TLKM	3600	20872500	0.006993007
2/18/2003	TLKM	3600	11579500	0
2/19/2003	TLKM	3600	7605000	0
2/20/2003	TLKM	3575	15183000	-0.006944444
2/21/2003	TLKM	3650	9074000	0.020979021
2/24/2003	TLKM	3700	14793000	0.01369863
2/25/2003	TLKM	3600	10975000	-0.027027027
2/26/2003	TLKM	3600	14192000	0
2/27/2003	TLKM	3600	3265000	0
2/28/2003	TLKM	3575	5266000	-0.006944444
3/4/2003	TLKM	3475	6546000	-0.027972028
3/5/2003	TLKM	3400	20511000	-0.021582734
3/6/2003	TLKM	3425	10134000	0.007352941
3/7/2003	TLKM	3375	12278000	-0.01459854
3/9/2003	TLKM	4800	25275000	0.422222222
3/10/2003	TLKM	3250	10220500	-0.322916667
3/11/2003	TLKM	3225	10544500	-0.007692308
3/12/2003	TLKM	3400	17847500	0.054263566
3/13/2003	TLKM	3325	10199500	-0.022058824
3/14/2003	TLKM	3425	28753500	0.030075188
3/17/2003	TLKM	3350	5636500	-0.02189781
3/18/2003	TLKM	3425	12456500	0.02238806
3/19/2003	TLKM	3400	5991000	-0.00729927
3/20/2003	TLKM	3550	22228000	0.044117647
3/21/2003	TLKM	3550	13265000	0
3/24/2003	TLKM	3625	27273000	0.021126761
3/25/2003	TLKM	3625	8963000	0
3/26/2003	TLKM	3700	18411500	0.020689655
3/27/2003	TLKM	3725	15307500	0.006756757
3/28/2003	TLKM	3725	7170000	0
3/31/2003	TLKM	3625	15734000	-0.026845638
4/1/2003	TLKM	3650	11731000	0.006896552
4/3/2003	TLKM	3675	7442500	0.006849315
4/4/2003	TLKM	3750	17865500	0.020408163
4/7/2003	TLKM	4000	32251500	0.066666667
4/8/2003	TLKM	3900	39758000	-0.025

4/9/2003	TLKM	4075	56540000	0.044871795
4/10/2003	TLKM	4100	15178000	0.006134969
4/11/2003	TLKM	4175	19474500	0.018292683
4/14/2003	TLKM	4075	12110000	-0.023952096
4/15/2003	TLKM	4175	20282500	0.024539877
4/16/2003	TLKM	4200	20978500	0.005988024
4/17/2003	TLKM	4125	7862000	-0.017857143
4/21/2003	TLKM	4125	8048500	0
4/22/2003	TLKM	4050	5011000	-0.018181818
4/23/2003	TLKM	4100	8930500	0.012345679
4/24/2003	TLKM	3975	25371500	-0.030487805
4/25/2003	TLKM	3850	23872000	-0.031446541
4/28/2003	TLKM	3825	23974000	-0.006493506
4/29/2003	TLKM	4000	36002500	0.045751634
4/30/2003	TLKM	4100	26657000	0.025
5/1/2003	TLKM	4100	11022000	0
5/2/2003	TLKM	4050	12766500	-0.012195122
5/5/2003	TLKM	4200	13638000	0.037037037
5/6/2003	TLKM	4225	18520000	0.005952381
5/7/2003	TLKM	4350	23465500	0.029585799
5/8/2003	TLKM	4350	12110500	0
5/9/2003	TLKM	4300	25304000	-0.011494253
5/12/2003	TLKM	4375	18285000	0.01744186
5/13/2003	TLKM	4375	19243000	0
5/14/2003	TLKM	4300	12128500	-0.017142857
5/19/2003	TLKM	4175	12332000	-0.029069767
5/20/2003	TLKM	4300	28643000	0.02994012
5/21/2003	TLKM	4325	11762500	0.005813953
5/22/2003	TLKM	4300	7877000	-0.005780347
5/23/2003	TLKM	4400	10176500	0.023255814
5/26/2003	TLKM	4450	16961500	0.011363636
5/27/2003	TLKM	4425	10323500	-0.005617978
5/28/2003	TLKM	4675	33185500	0.056497175
5/29/2003	TLKM	4675	17124000	0
6/2/2003	TLKM	4950	26089000	0.058823529
6/3/2003	TLKM	4825	20443500	-0.025252525
6/4/2003	TLKM	4600	14649500	-0.046632124
6/5/2003	TLKM	4650	19003000	0.010869565
6/6/2003	TLKM	4575	17442000	-0.016129032
6/9/2003	TLKM	4675	14339000	0.021857923
6/10/2003	TLKM	4675	9049000	0
6/11/2003	TLKM	4675	23028500	0
6/12/2003	TLKM	4350	79357500	-0.069518717
6/13/2003	TLKM	4550	34639000	0.045977011
6/16/2003	TLKM	4575	15724000	0.005494505
6/17/2003	TLKM	4550	32478500	-0.005464481
6/18/2003	TLKM	4500	22415000	-0.010989011
6/19/2003	TLKM	4500	27372000	0
6/20/2003	TLKM	4450	23799000	-0.011111111
6/23/2003	TLKM	4300	30660000	-0.033707865

6/24/2003	TLKM	4300	20074500	0
6/25/2003	TLKM	4375	15723500	0.01744186
6/26/2003	TLKM	4425	13144000	0.011428571
6/27/2003	TLKM	4600	25811000	0.039548023
6/30/2003	TLKM	4625	13490000	0.005434783
7/1/2003	TLKM	4725	29021000	0.021621622
7/2/2003	TLKM	4625	14563500	-0.021164021
7/3/2003	TLKM	4550	13195000	-0.016216216
7/4/2003	TLKM	4525	3074500	-0.005494505
7/7/2003	TLKM	4625	17820500	0.022099448
7/8/2003	TLKM	4700	14017500	0.016216216
7/9/2003	TLKM	4650	2679500	-0.010638298
7/10/2003	TLKM	4650	5535000	0
7/11/2003	TLKM	4700	6943000	0.010752688
7/14/2003	TLKM	4700	5930500	0
7/15/2003	TLKM	4700	9834500	0
7/16/2003	TLKM	4650	4388000	-0.010638298
7/17/2003	TLKM	4700	6251500	0.010752688
7/18/2003	TLKM	4725	3910500	0.005319149
7/21/2003	TLKM	4700	5933500	-0.005291005
7/22/2003	TLKM	4625	11461000	-0.015957447
7/23/2003	TLKM	4650	14771000	0.005405405
7/24/2003	TLKM	4475	28386000	-0.037634409
7/25/2003	TLKM	4475	17838500	0
7/28/2003	TLKM	4500	14786500	0.005586592
7/29/2003	TLKM	4450	12589000	-0.011111111
7/30/2003	TLKM	4375	9154000	-0.016853933
7/31/2003	TLKM	4400	12483500	0.005714286
8/1/2003	TLKM	4400	20064000	0
8/4/2003	TLKM	4300	9878500	-0.022727273
8/5/2003	TLKM	4125	60694500	-0.040697674
8/6/2003	TLKM	4250	28519000	0.03030303
8/7/2003	TLKM	4425	31809000	0.041176471
8/8/2003	TLKM	4250	41388500	-0.039548023
8/9/2003	TLKM	5400	12020000	0.270588235
8/11/2003	TLKM	4200	12201000	-0.222222222
8/12/2003	TLKM	4200	15699000	0
8/13/2003	TLKM	4275	12142500	0.017857143
8/14/2003	TLKM	4300	8410000	0.005847953
8/15/2003	TLKM	4500	30504000	0.046511628
8/19/2003	TLKM	4600	35644500	0.022222222
8/20/2003	TLKM	4625	12560500	0.005434783
8/21/2003	TLKM	4600	17221500	-0.005405405
8/22/2003	TLKM	4650	4732000	0.010869565
8/25/2003	TLKM	4625	14676000	-0.005376344
8/26/2003	TLKM	4625	8869500	0
8/27/2003	TLKM	4650	2976500	0.005405405
8/28/2003	TLKM	4625	11720500	-0.005376344
8/29/2003	TLKM	4575	9093500	-0.010810811
9/1/2003	TLKM	4625	9126000	0.010928962

9/2/2003	TLKM	4600	8887500	-0.005405405
9/3/2003	TLKM	4800	25275000	0.043478261
9/4/2003	TLKM	5050	23827500	0.052083333
9/5/2003	TLKM	5300	24863000	0.04950495
9/8/2003	TLKM	5400	12020000	0.018867925
9/9/2003	TLKM	5300	6375500	-0.018518519
9/10/2003	TLKM	5100	13354500	-0.037735849
9/11/2003	TLKM	4950	12958000	-0.029411765
9/12/2003	TLKM	5125	15951000	0.035353535
9/15/2003	TLKM	5150	8310500	0.004878049
9/16/2003	TLKM	5200	14756000	0.009708738
9/17/2003	TLKM	5300	4909500	0.019230769
9/18/2003	TLKM	5300	6709000	0
9/19/2003	TLKM	5300	10708500	0
9/23/2003	TLKM	5500	7933500	0.037735849
9/24/2003	TLKM	6000	21706000	0.090909091
9/25/2003	TLKM	5700	14217000	-0.05
9/26/2003	TLKM	5650	6606500	-0.00877193
9/29/2003	TLKM	5700	7870000	0.008849558
9/30/2003	TLKM	5700	14022500	0
10/1/2003	TLKM	6100	13872000	0.070175439
10/2/2003	TLKM	6450	28440000	0.057377049
10/3/2003	TLKM	6350	14848500	-0.015503876
10/6/2003	TLKM	6100	21794000	-0.039370079
10/7/2003	TLKM	6050	19218500	-0.008196721
10/8/2003	TLKM	6100	15618500	0.008264463
10/9/2003	TLKM	6200	14578000	0.016393443
10/10/2003	TLKM	6300	12365500	0.016129032
10/13/2003	TLKM	6100	15924000	-0.031746032
10/14/2003	TLKM	6150	20207500	0.008196721
10/15/2003	TLKM	6100	8893000	-0.008130081
10/16/2003	TLKM	6050	7514000	-0.008196721
10/17/2003	TLKM	6100	2445000	0.008264463
10/20/2003	TLKM	6250	12909500	0.024590164
10/21/2003	TLKM	6200	8305000	-0.008
10/22/2003	TLKM	6250	6760000	0.008064516
10/23/2003	TLKM	6050	16509500	-0.032
10/24/2003	TLKM	6050	5655500	0
10/27/2003	TLKM	6050	5730500	0
10/28/2003	TLKM	6150	10351500	0.016528926
10/29/2003	TLKM	6100	10195000	-0.008130081
10/30/2003	TLKM	6100	8347000	0
10/31/2003	TLKM	6000	10261500	-0.016393443
11/3/2003	TLKM	5800	15781500	-0.033333333
11/4/2003	TLKM	5650	32597500	-0.025862069
11/5/2003	TLKM	6050	22155500	0.07079646
11/6/2003	TLKM	6150	22384000	0.016528926
11/7/2003	TLKM	5850	25741000	-0.048780488
11/10/2003	TLKM	5700	20811500	-0.025641026
11/11/2003	TLKM	5700	20634000	0

11/12/2003	TLKM	5900	15248500	0.035087719
11/13/2003	TLKM	5850	4531500	-0.008474576
11/14/2003	TLKM	5700	12634000	-0.025641026
11/17/2003	TLKM	5950	5138500	0.043859649
11/18/2003	TLKM	5950	11720000	0
11/19/2003	TLKM	5900	10494000	-0.008403361
11/20/2003	TLKM	6000	8998000	0.016949153
11/21/2003	TLKM	6150	19991000	0.025
12/1/2003	TLKM	6100	11697500	-0.008130081
12/2/2003	TLKM	6150	11747000	0.008196721
12/3/2003	TLKM	6200	11898000	0.008130081
12/4/2003	TLKM	6100	7021000	-0.016129032
12/5/2003	TLKM	6000	4206000	-0.016393443
12/8/2003	TLKM	6100	11318500	0.016666667
12/9/2003	TLKM	6050	5904000	-0.008196721
12/10/2003	TLKM	6050	10410500	0
12/11/2003	TLKM	6200	12446500	0.024793388
12/12/2003	TLKM	6200	7144000	0
12/15/2003	TLKM	6400	12285500	0.032258065
12/16/2003	TLKM	6350	3308500	-0.0078125
12/17/2003	TLKM	6350	11929500	0
12/18/2003	TLKM	6400	16128000	0.007874016
12/19/2003	TLKM	6450	8950500	0.0078125
12/22/2003	TLKM	6300	11227500	-0.023255814
12/23/2003	TLKM	6450	9070000	0.023809524
12/29/2003	TLKM	6650	7828000	0.031007752
12/30/2003	TLKM	6750	9136500	0.015037594