

# THERAPY AND HEALTH CENTER FOR AUTISM KIDS

Perancangan yang diusulkan adalah Pusat Terapi dan Kesehatan untuk Anak ( Khususnya Bagi Anak Penderita Autis) dengan pendekatan Sistem Kontrol Lingkungan. Autism Spectrum Disorder (ASD) atau biasa disebut dengan Autisme merupakan suatu kelainan neurologis dan perkembangan yang dimulai pada masa kanak-kanak dan dapat bertahan seumur hidup. Pusat Terapi atau Therapy Center adalah suatu tempat dimana seluruh aktifitas kegiatan yang berhubungan dengan usaha untuk memulihkan kesehatan suatu orang dilakukan di tempat tersebut. Perancangan ini merupakan respon dari isu permasalahan yang terdapat pada Piyungan adalah kurangnya fasilitas kesehatan dan untuk di Yogyakarta kurangnya tempat terapi bagi anak autis dimana pusat terapi yang ada sudah tidak mampu untuk menampung pendaftar yang ada.

Perancangan Pusat Terapi dan Kesehatan untuk Anak ( Khususnya Bagi Anak Penderita Autis) dengan pendekatan Sistem Kontrol Lingkungan dalam ini diusulkan untuk merespon isu permasalahan utama yang ada di kecamatan Piyungan yaitu limbah dan polusi. Dimana ini berbanding terbalik dengan Pusat Terapi dan Kesehatan yang tentu membutuhkan area yang higienis, apalagi anak autis mempunyai indra yang sangat sensitive sehingga kendaraan yang lalu lalang tentu akan sangat mengganggu anak autis tersebut. Untuk itulah dibutuhkan Environmental Control System untuk mengatur agar sesuai dengan kenyamanan dalam bangunan. Berdasarkan hal tersebut, maka dibutuhkan perancangan Pusat Terapi dan Kesehatan untuk Anak ( Khususnya Bagi Anak Penderita Autis) dengan pendekatan Sistem Kontrol Lingkungan.

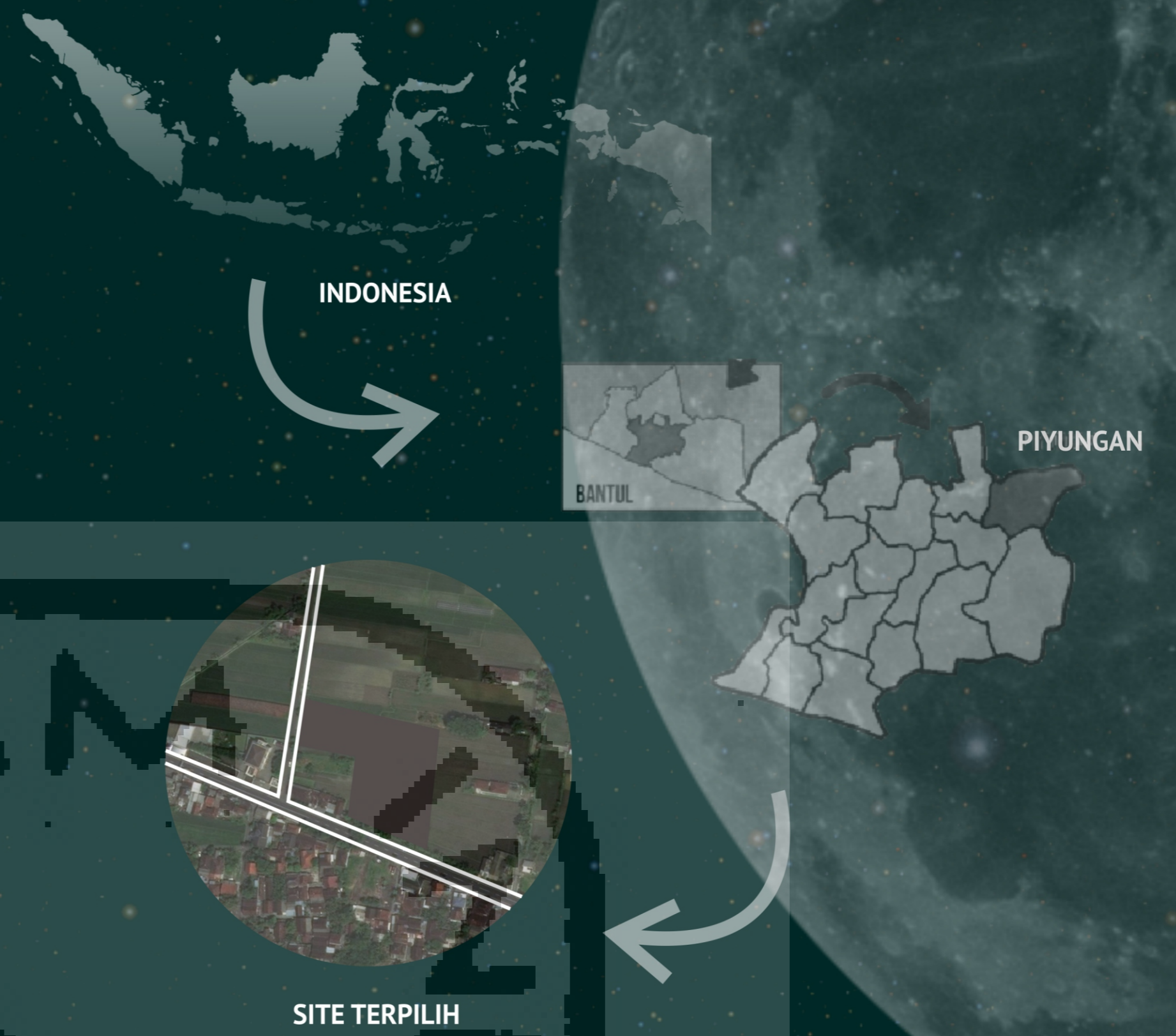

## Permasalahan Umum

Bagaimana merancang Therapy Center untuk anak penderita autisme dengan pendekatan Environmental Control System untuk kenyamanan indera sensoris anak?



## Permasalahan Khusus

- Bagaimana merancang Pusat Terapi dan Kesehatan untuk anak khususnya anak autisme agar nyaman (termal, akustik, dan pencahayaan) melalui Environmental Control Systems?
- Bagaimana merancang sirkulasi ruang yang dapat merangsang indera anak autisme melalui Sensory Design?
- Bagaimana merancang lansekap sebagai ruang interaksi anak yang interaktif dengan menerapkan material yang aman bagi anak?

## REGULASI

### Arahan Kepadatan Bangunan

75%

6.000 M<sup>2</sup>

Dikarenakan bangunan Therapy and Health Center masuk ke dalam kategori fasilitas lingkungan, maka arahan kepadatan bangunannya adalah kepadatan bangunan tinggi dimana KDB paling minimumnya adalah 50% dan KDB maksimumnya adalah 75%. Dengan luas lahan adalah 9000 m<sup>2</sup> maka area yang menyentuh tanah yang boleh dibangun adalah 75% x 8000 m<sup>2</sup> = 6.000 m<sup>2</sup>.

### Rencana Ketinggian Bangunan

8M

Bangunan yang akan dirancang memiliki tipologi yang sama dengan puskesmas pembantu, sehingga memiliki ketentuan ketinggian maksimum adalah 8 m dan tidak berhenti.

### Garis Sempadan Bangunan

2 – 4 METER

>12 METER

Berdasarkan dari ketentuan tersebut maka dapat ditarik analisis, untuk Sempadan Pagar dengan lebar jalan utama 12 m maka setengahnya adalah 6 m. Untuk Sempadan Muka Jalan adalah >12 m diukur dari Pagar Bangunan terhadap muka bangunan yang akan dibangun. Sedangkan untuk Sempadan Samping Bangunan minimal adalah 2 – 4 m dihitung dari batas site ke bangunan yang akan dibangun.

## PETA PERSOALAN

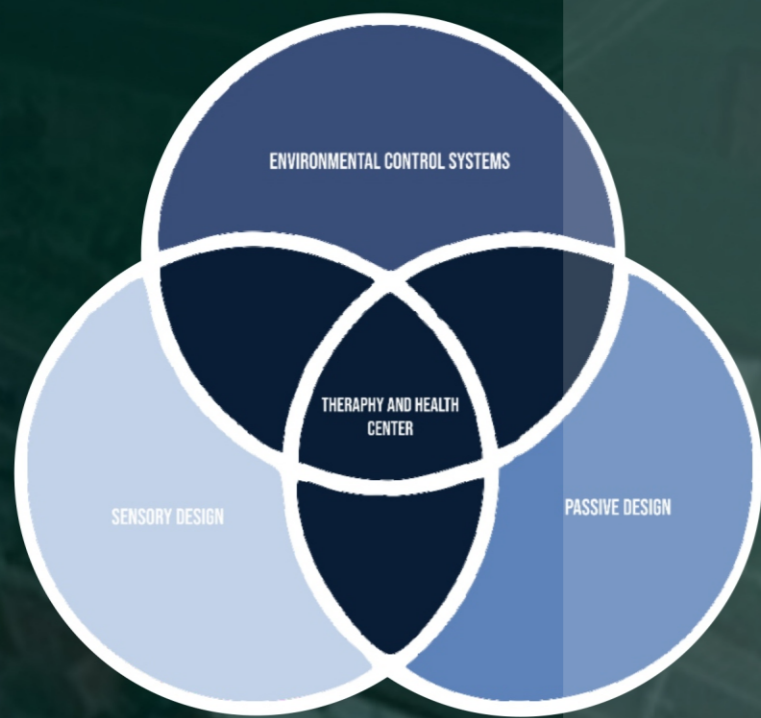

## PETA PERMASALAHAN

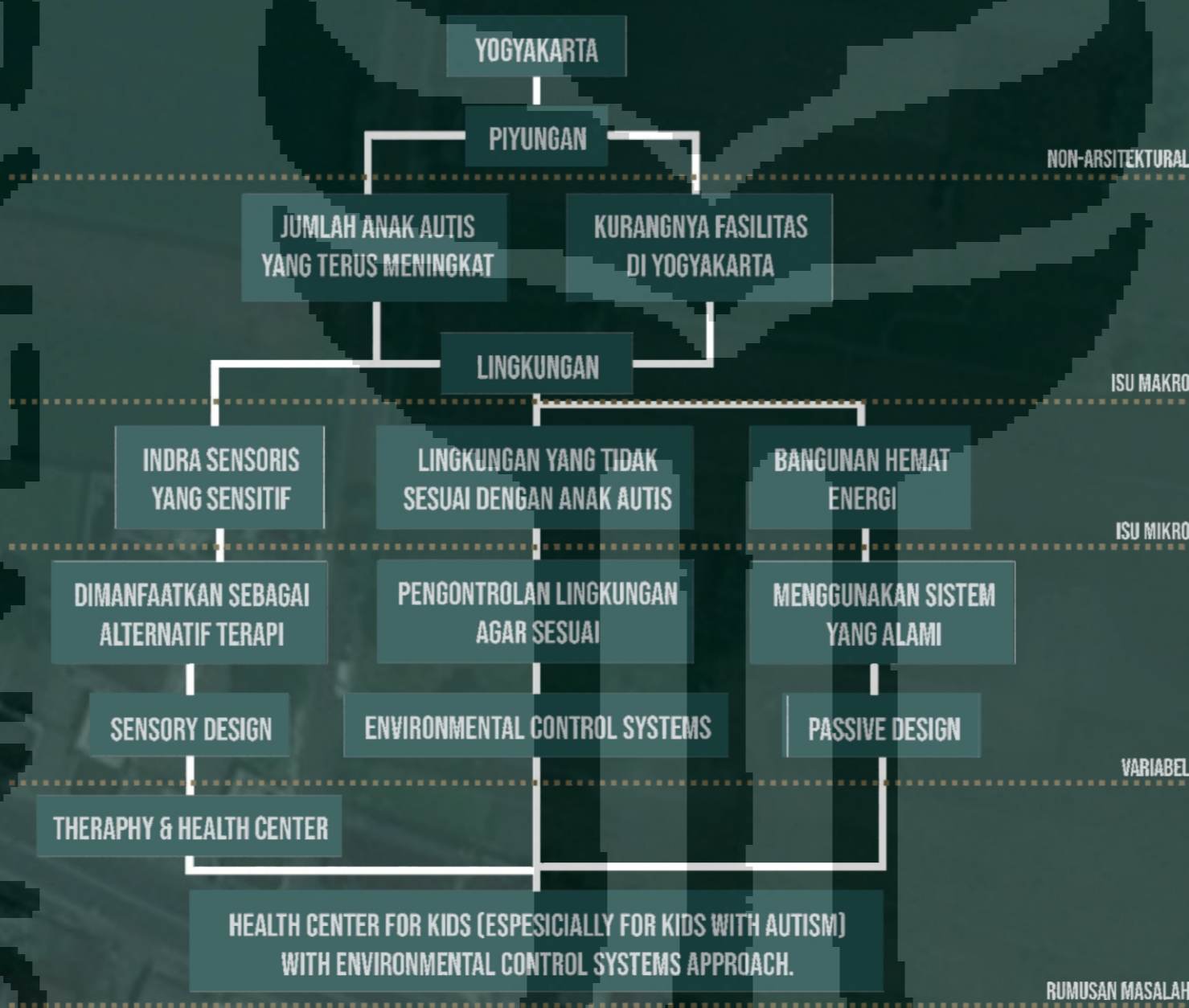

## DATA SITE

### Klimatologi

Kategori	Sub Kategori	Bulan												Tahun	Rata-rata	Maksimal	Minimal	Keterangan	
		Jan	Feb	Mar	Apr	Mei	Jun	Jul	Ag	Sep	Ok	Nov	Des						
Suhu	Suhu Udara	28,0	28,0	28,0	28,0	28,0	28,0	28,0	28,0	28,0	28,0	28,0	28,0	28,0	28,0	28,0	28,0	28,0	28,0
	Suhu Basah	24,0	24,0	24,0	24,0	24,0	24,0	24,0	24,0	24,0	24,0	24,0	24,0	24,0	24,0	24,0	24,0	24,0	24,0
Kelembaban	Kelembaban Relatif	75	75	75	75	75	75	75	75	75	75	75	75	75	75	75	75	75	75
	Kelembaban Absolut	18,0	18,0	18,0	18,0	18,0	18,0	18,0	18,0	18,0	18,0	18,0	18,0	18,0	18,0	18,0	18,0	18,0	18,0
Angin	Kecepatan Angin	2,0	2,0	2,0	2,0	2,0	2,0	2,0	2,0	2,0	2,0	2,0	2,0	2,0	2,0	2,0	2,0	2,0	2,0
	Arah Angin	100	100	100	100	100	100	100	100	100	100	100	100	100	100	100	100	100	100
Curah Hujan	Curah Hujan	100	100	100	100	100	100	100	100	100	100	100	100	100	100	100	100	100	100
	Kelembaban	75	75	75	75	75	75	75	75	75	75	75	75	75	75	75	75	75	75

### Matahari

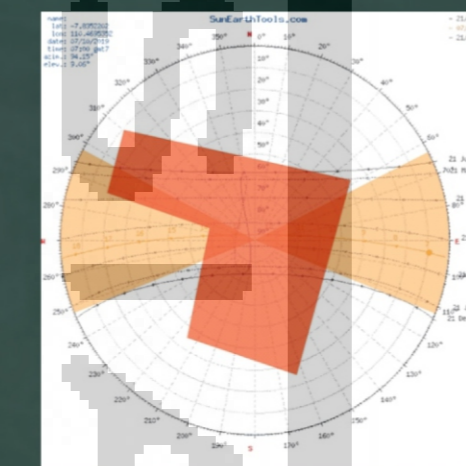

### Angin

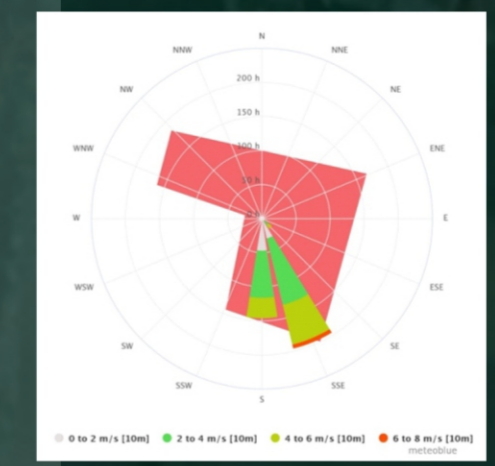

## PETA KONFLIK



## KAJIAN TIPOLOGI

A Centre For Autism – New Struan (Aitken Turnbull Architect, 2005)



Hal yang dapat dipelajari pada bangunan ini adalah bagaimana arsitek menerapkan daylighting pada sirkulasi bangunan dengan menerapkan bukaan pada naungan bangunan yang diberi nama "the gull wing".

The Pears National Centre For Autism (Penoyre & Prasad, 2008)



Hal yang dapat dipelajari dari bangunan ini adalah penggunaan material dan sistem yang berkelanjutan dan memberikan ruang-ruang dimana pasien dan orang tua pasien dapat mengerti satu sama lain. Selain itu juga perlunya furniture dan ruang yang fleksibel mengikuti tipe terapi yang sedang dilakukan.

Lerner School For Autism (DLR Group, 2008)



Hal yang dapat dipelajari dalam bangunan ini adalah bagaimana menggabungkan bangunan dengan fungsi yang berbeda yaitu edukasi dan kesehatan dalam bangunan dengan memberikan efek sensoris pada material dan selubung bangunan.

Abu Dhabi Autism Center (Simon Humphreys Architect, 2012)



Penggunaan material dan warna-warna yang senada dapat memberikan efek menenangkan dan arsitek lebih sebisa mungkin menghindari penggunaan warna yang mencolok untuk menghindari rangsangan berlebih pada anak autisme. Secondary skin pada bangunan membuat bangunan tetap mendapatkan daylighting dan penghawaan alami tanpa harus mengekpos dalam bangunan.

# ANALISIS MATAHARI

## Analisis Matahari Terhadap Ruang

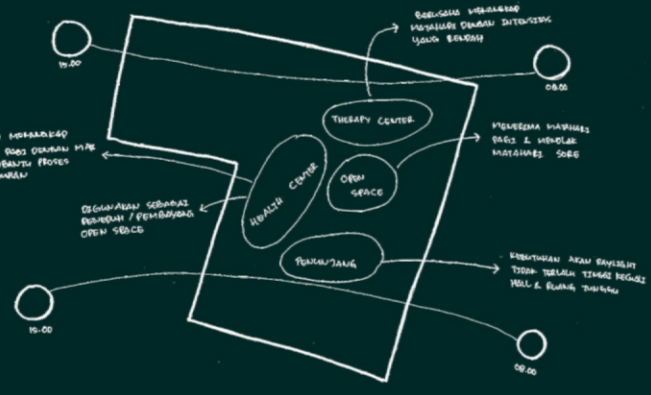

Sisi site yang terkena cahaya matahari diperuntukkan untuk ruang-ruang yang menggunakan daylighting sebagai pencahayaan utamanya.

## Analisis Matahari Terhadap Massa Bangunan

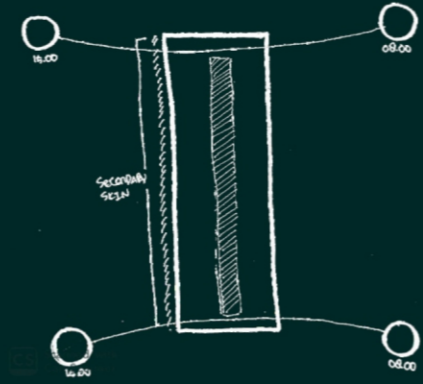

Sisi site yang terkena cahaya matahari diperuntukkan untuk ruang-ruang yang menggunakan daylighting sebagai pencahayaan utamanya, seperti ruang terapi okupasi, mushalla, foodcourt, dll. Selain pemasangan shading, penggunaan vegetasi pada selubung bangunan juga dapat mereduksi panas. Selubung dengan vegetasi akan digunakan pada fungsi bangunan penunjang dan health center untuk mengurangi rasa tegang pada anak sebelum berobat.

## Analisis Matahari Terhadap Lanskap

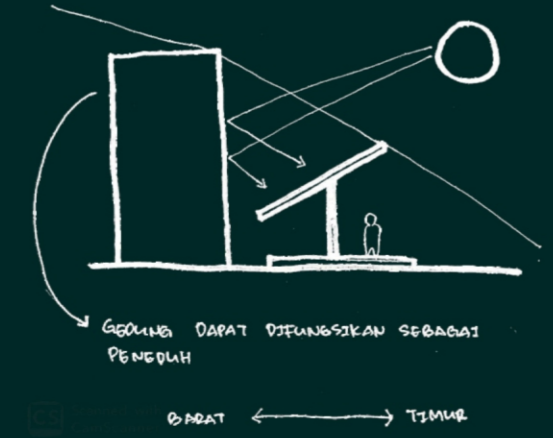

Perancangan lanskap cukup berpengaruh penting dalam proses terapi dan penyembuhan. Pada beberapa titik (meeting point) perlu dipasang atap dengan kemiringan ke arah barat untuk menghalau radiasi pantulan dari gedung.

# ANALISIS ANGIN

## Analisis Angin Terhadap Massa Bangunan

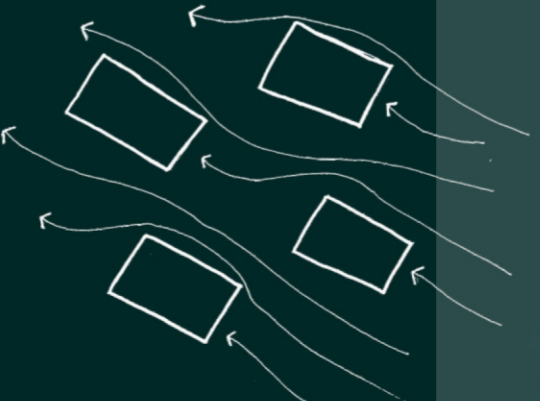

Massa bangunan dipecah menjadi massa-massa kecil agar angin lebih mudah di distribusikan ke ruang-ruang yang membutuhkan. Selain itu, massa-massa kecil juga tidak menghalangi angin melewati bangunan di belakangnya.

## Analisis Angin Terhadap Ruang

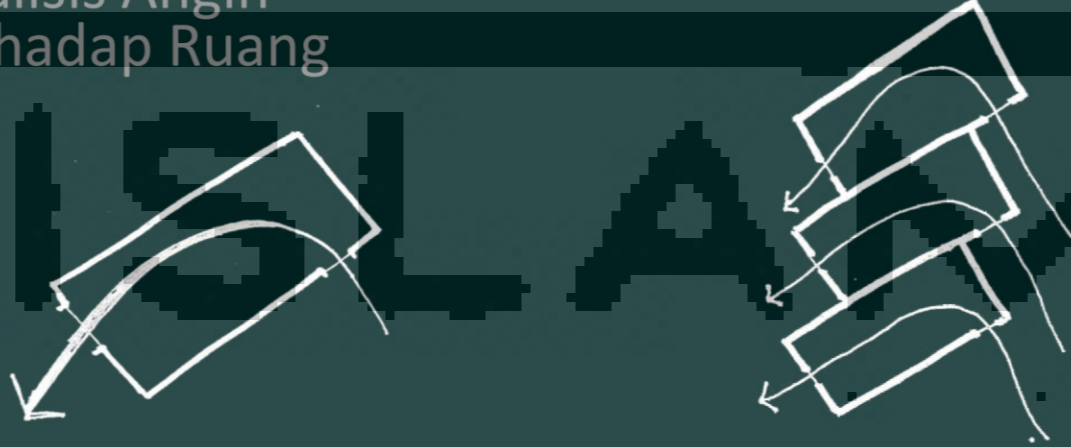

Untuk ruang-ruang yang menggunakan passive cooling, ruang harus memiliki 2 ventilasi (inlet dan outlet) agar cross ventilation dapat tercipta. Cross ventilation dibutuhkan agar terjadi pertukaran udara di dalam ruangan. Tidak adanya pertukaran udara akan menyebabkan udara di dalam ruang akan kotor dan berdebu yang akan membuat anak menjadi sakit dan dapat memicu alergi pada anak.

## Analisis Angin Terhadap Lanskap



Massa bangunan dipecah menjadi massa-massa kecil agar angin lebih mudah di distribusikan ke ruang-ruang yang membutuhkan. Selain itu, massa-massa kecil juga tidak menghalangi angin melewati bangunan di belakangnya.

# ANALISIS AKSESIBILITAS BANGUNAN

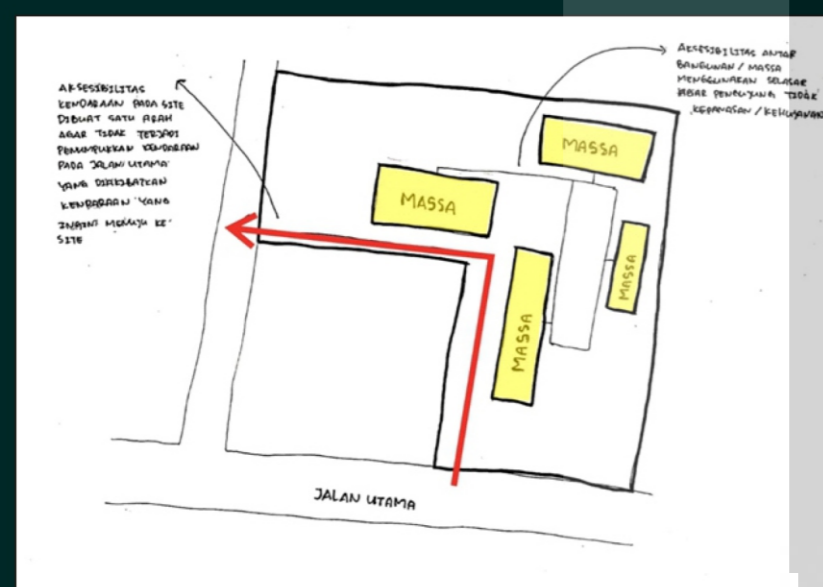

Aksesibilitas bagi kendaraan pada site dibuat searah agar tidak terjadi penumpukan kendaraan pada jalan utama akibat kendaraan yang ingin masuk atau keluar site. Pada kolom-kolom selasar akan ditanam vegetasi dimana menurut Antonovsky (1996), vegetasi pada taman dapat membantu proses penyembuhan pasien.

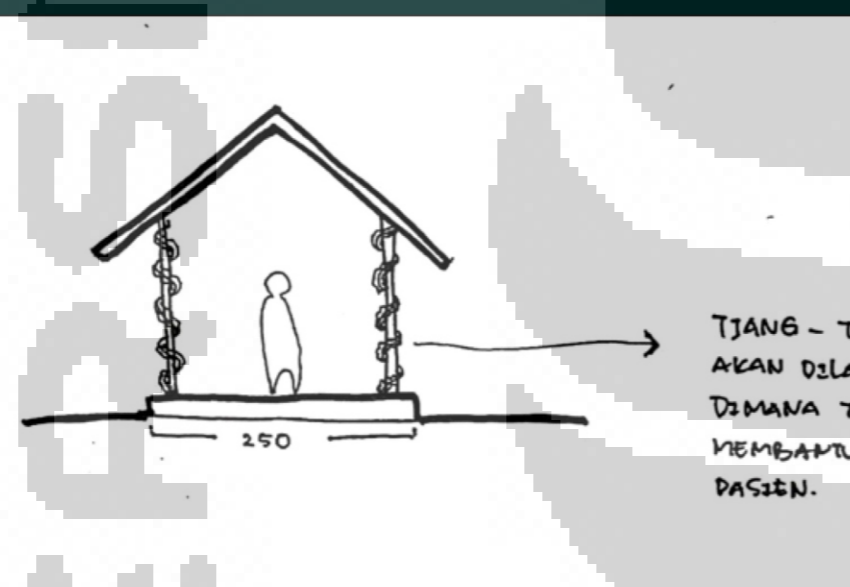

Aksesibilitas pada ruang health center dibuat semudah dan sesimpel mungkin agar tidak membingungkan pasien. Dimana ruang-ruang poliklinik berada disisi-sisi koridor. Untuk ruang tunggunya sendiri akan dipecah-pecah seperti pada gambar agar orangtua atau wali anak dapat mengawasi anak mereka dari segala arah ketika anak mereka bermain atau berjalan-jalan di sekitaran bangunan.

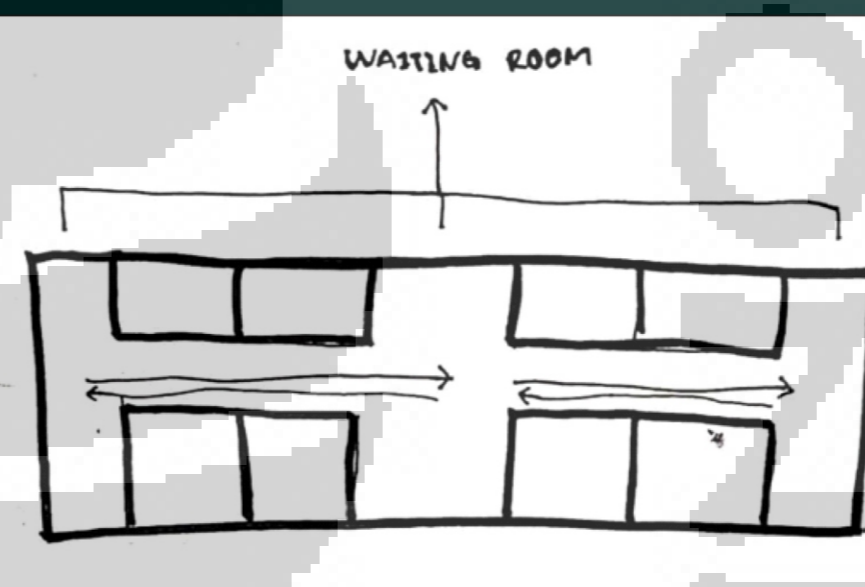

Aksesibilitas pada bangunan therapy center dihindari agar tercipta koridor yang sempit karena akan membuat anak autis menjadi depresi dan stress. Oleh karenanya, sirkulasi dibuat seperti gambar 3.39 yang sirkulasinya tidak monoton lurus namun juga sirkulasi tidak berada diantara 2 ruang sehingga anak autis dapat memandang ke arah taman atau landscape.

# KONSEP SITEPLAN

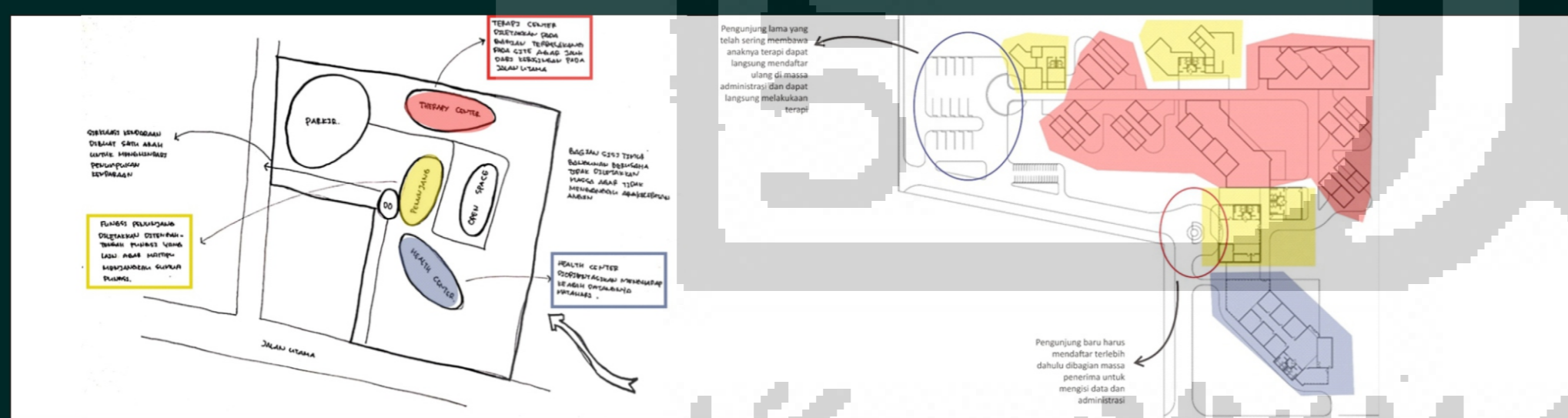

# KONSEP BANGUNAN HEALTH CENTER

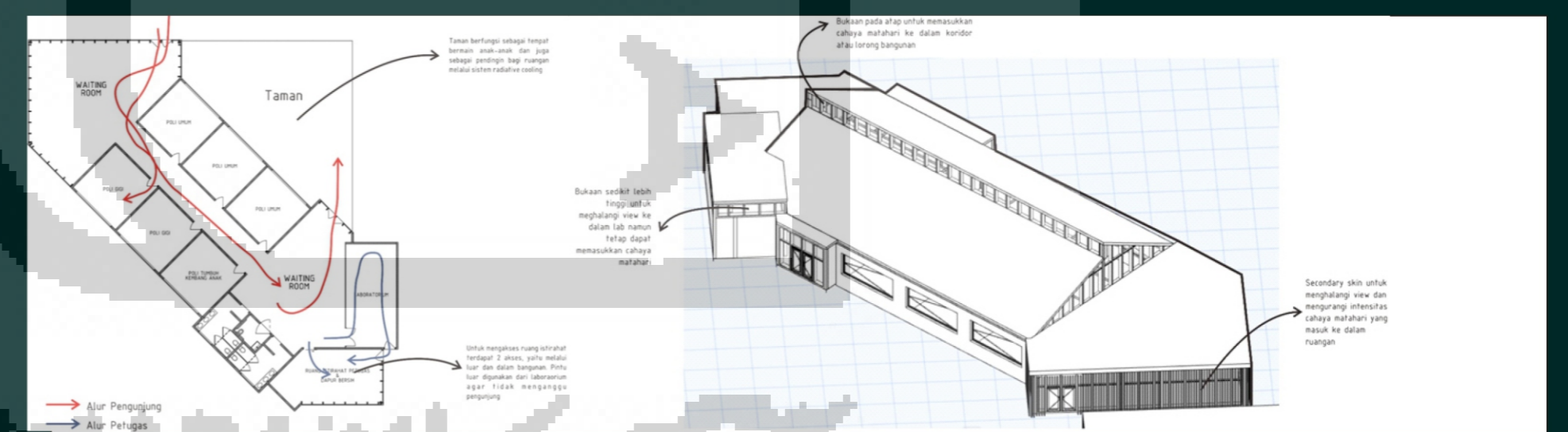

# KONSEP BANGUNAN PENUNJANG

## Massa Penerima

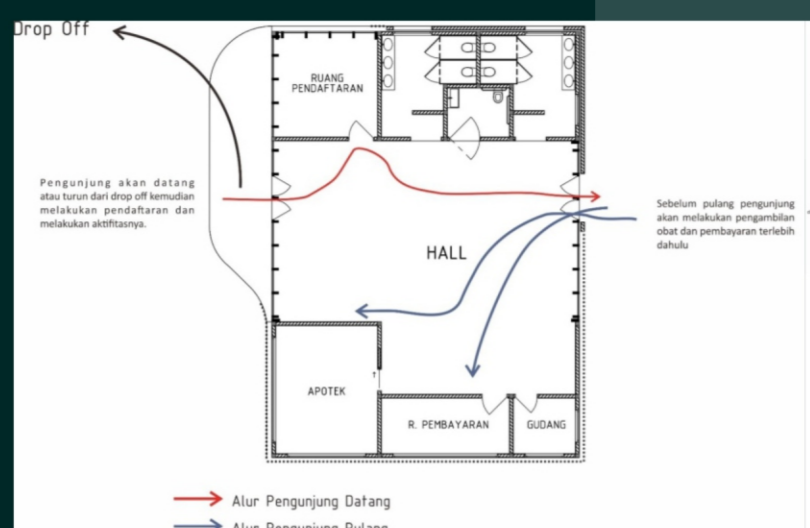

## Massa Administrasi dan Ruang Kerja

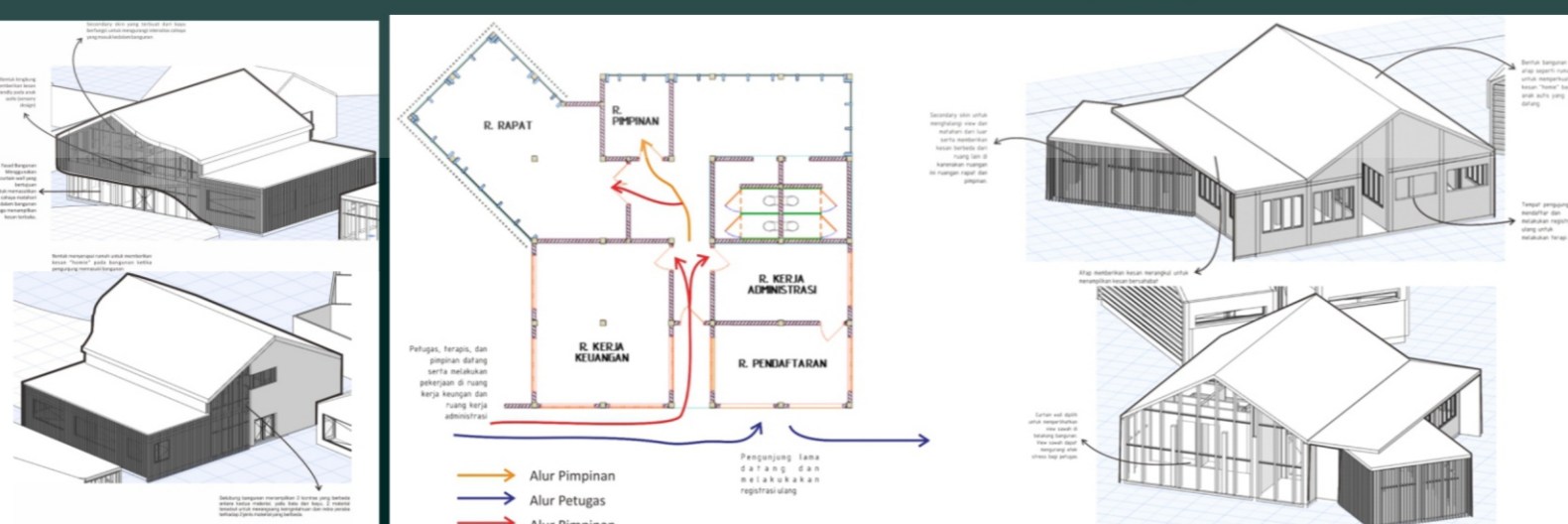

## Massa Food Court dan Mushalla

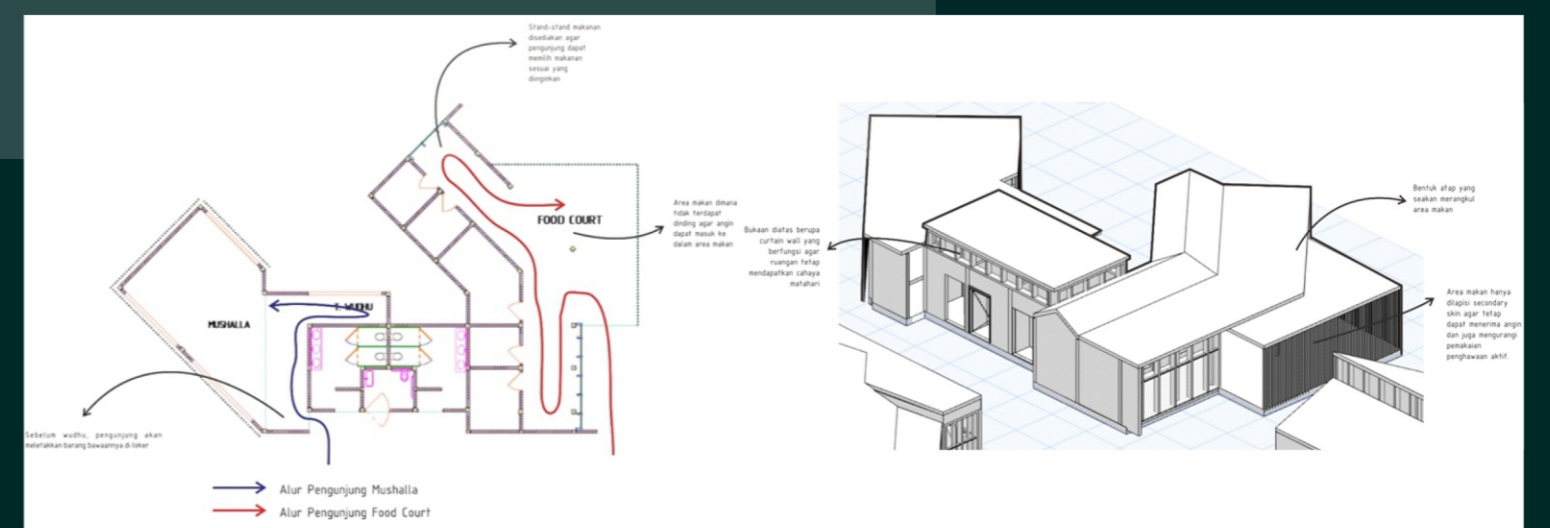

# KONSEP BANGUNAN THERAPY CENTER

## Massa Ruang Terapi Okupasi dan Terapi Wicara

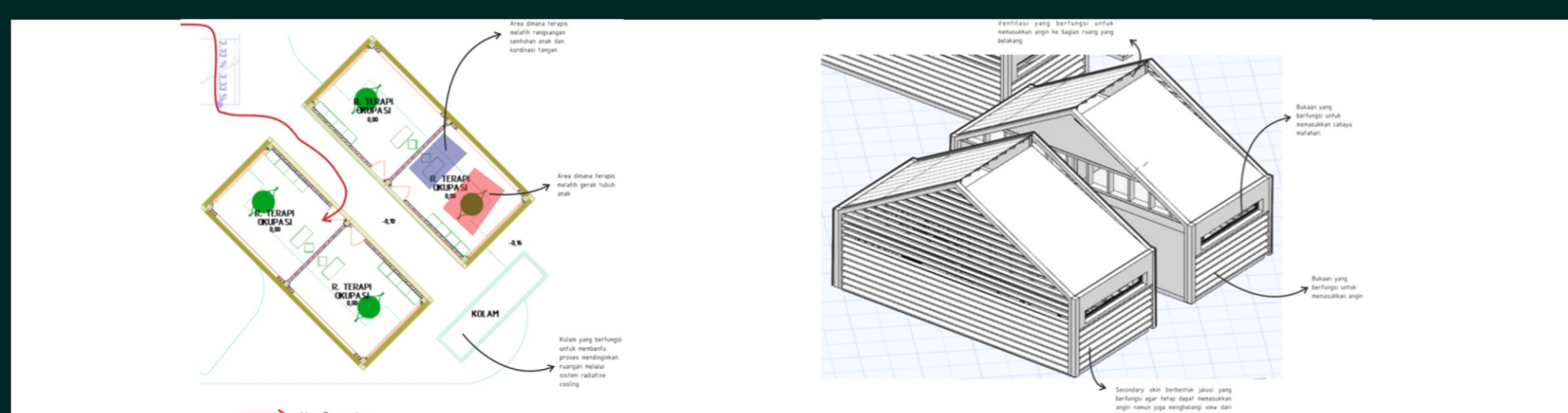

## Massa Ruang Terapi Klasikal

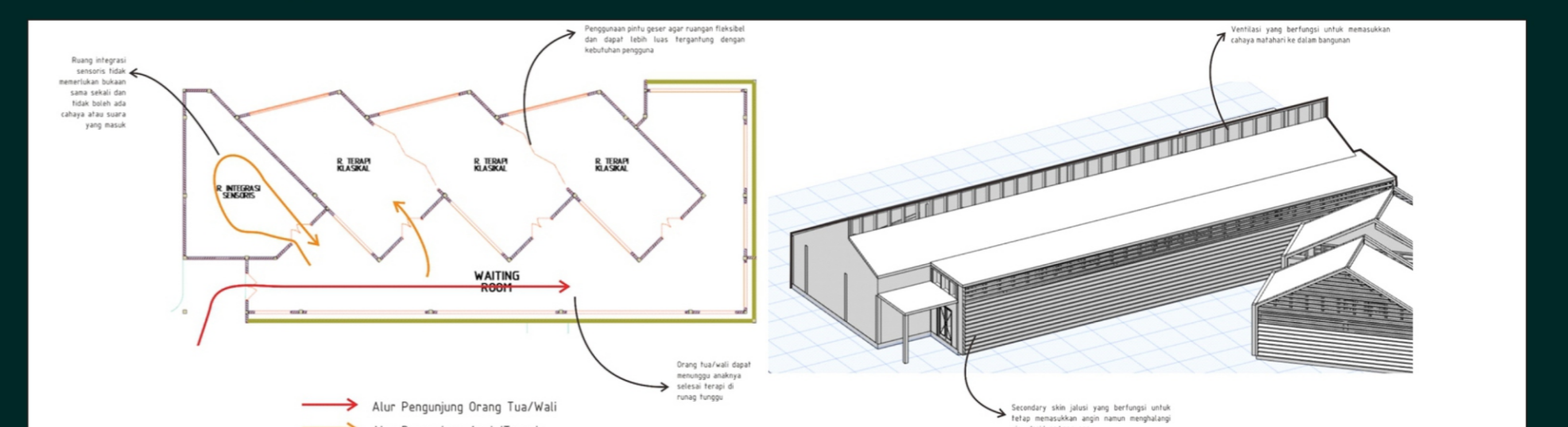

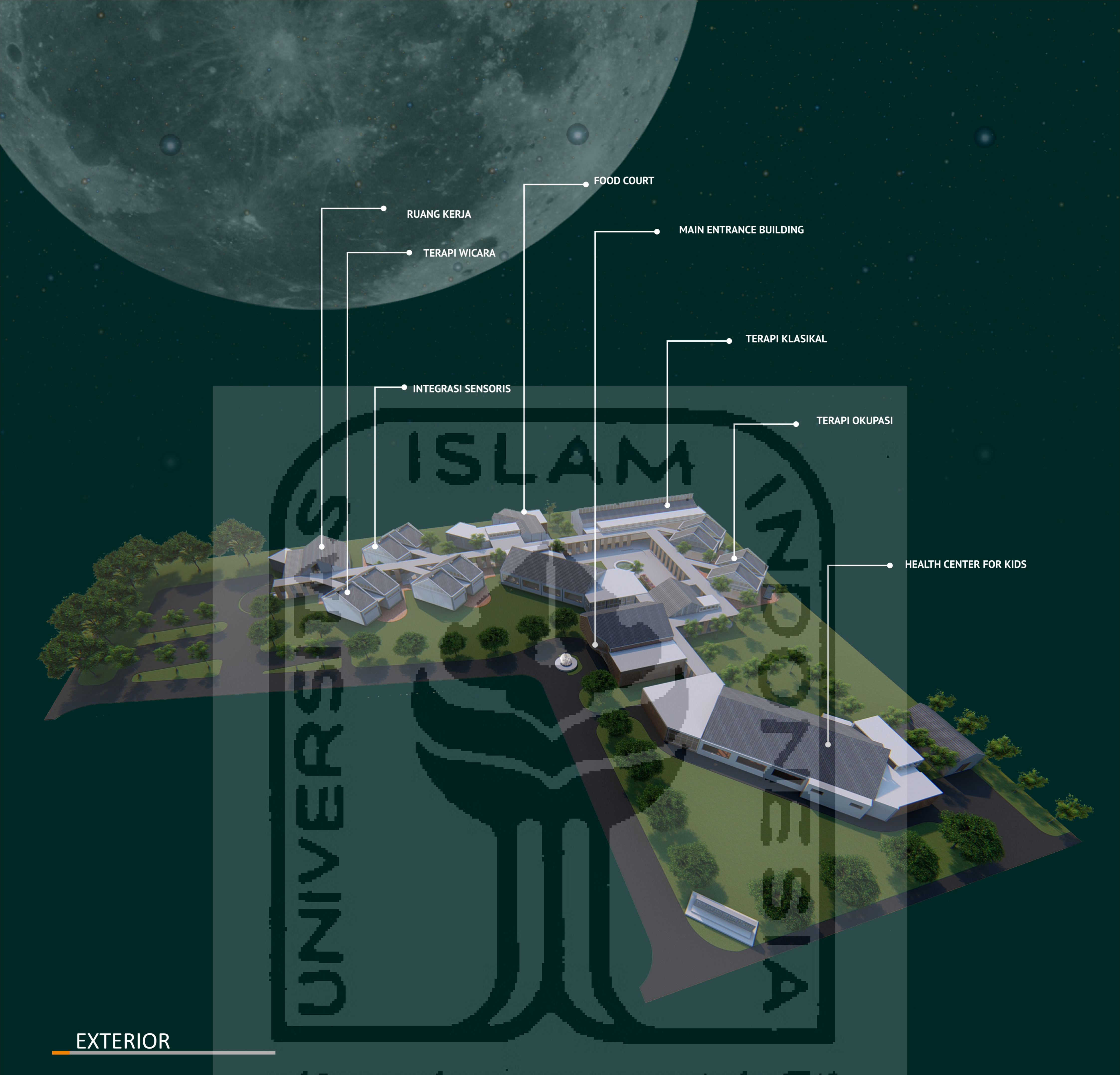

**EXTERIOR**



**INTERIOR**



# DAFTAR ISI

---

01	SITUASI	16	SKEMA TRANSPORTASI VERTIKAL
02	SITEPLAN	17	SKEMA PENANGGULANGAN KEBAKARAN
03	DENAH PENUNJANG	18	SKEMA BARRIER FREE
04	DENAH HEALTH CENTER	19	DETAIL SECONDARY SKIN
05	DENAH THERAPY CENTER	20	DETAIL VENTILASI
06	POTONGAN	21	DETAIL ARSITEKTURAL KHUSUS
07	TAMPAK KAWASAN	22	PERSPEKTIF EKSTERIOR
08	DENAH & POTONGAN PARSIAL	23	PERSPEKTIF INTERIOR
09	TAMPAK PARSIAL	09	TAMPAK PARSIAL
10	SKEMA STRUKTUR		
11	SKEMA AIR BERSIH		
12	SKEMA AIR KOTOR		
13	SKEMA PENYEDIAAN ENERGI		
14	SKEMA PENGHAWAAN		
15	SKEMA PENCAHAYAAN		



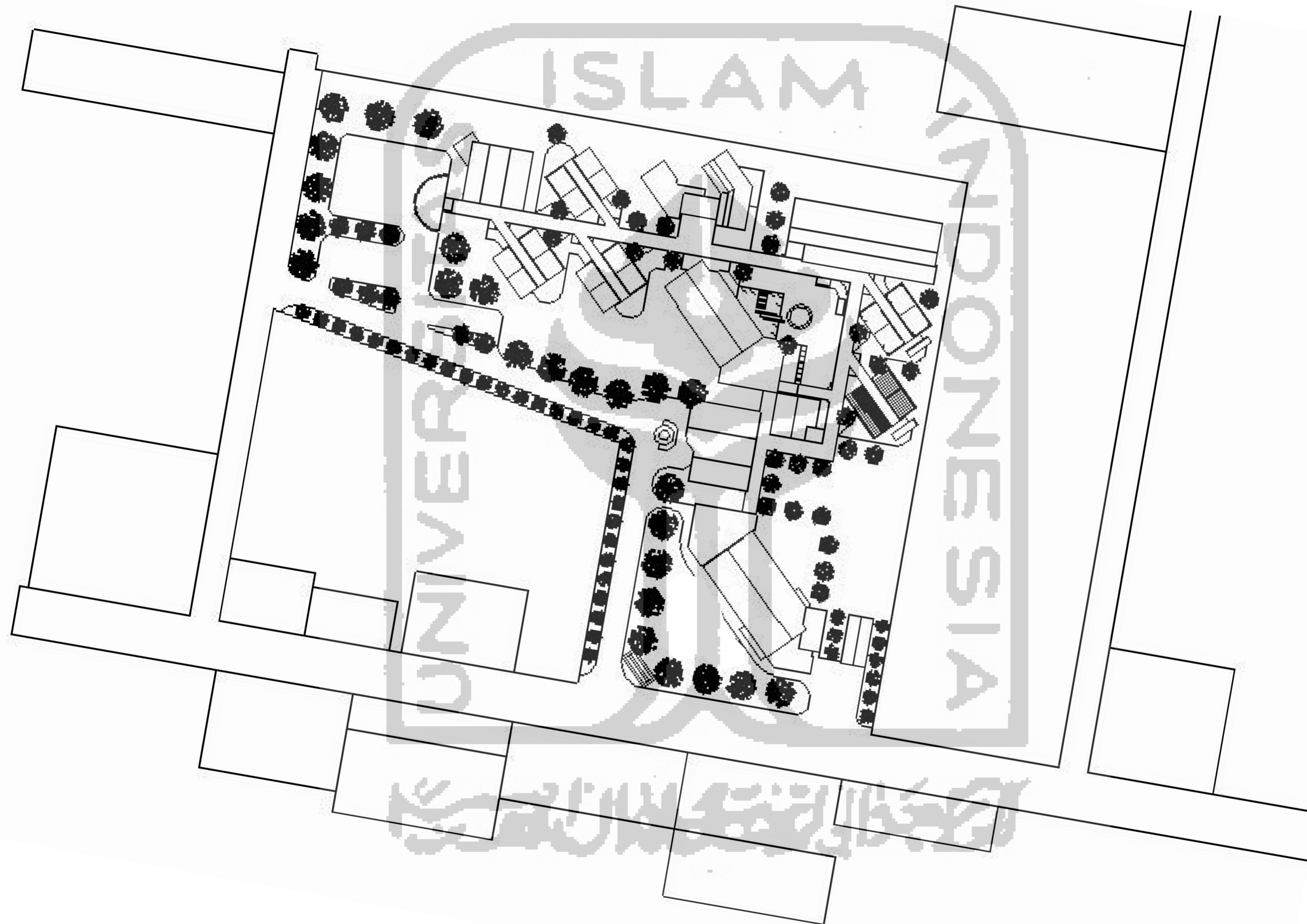

KETERANGAN DESCRIPTION

**CATATAN**  
 THESE DRAWINGS ARE AN INSTRUMENT OF SERVICE AND ARE THE PROPERTY OF THE CREATOR. ANY USE OF THE DRAWINGS WITHOUT THE PRIOR EXPRESS WRITTEN PERMISSION OF THE CREATOR IS A VIOLATION OF COPYRIGHT AND WILL BE LIABLE TO PROSECUTION. DO NOT SCALE FROM DRAWINGS. USE ONLY GIVEN DIMENSIONS. ALL DIMENSIONS ARE IN MILLIMETRES UNLESS OTHERWISE NOTED.

PERSETUJUAN APPROVAL

**DYAH HENDRAWATI, ST., MSc.**

REV	DATE	REVISION STATUS	SIGN
△			
△			
△			

PROJEK PROJECT

**PERANCANGAN PUSAT TERAPI & KESEHATAN KHUSUS ANAK AUTIS**

INSTITUSI INSTITUTION  
 JURUSAN SARJANA ARSITEKTUR  
 FAKULTAS TEKNIK DAN PERENCANAAN  
 UNIVERSITAS ISLAM INDONESIA

NAMA NAME  
**MUHAMMAD EDY PRATAMA SURYA**

NOMOR INDUK MAHASISWA  
**155121095**

DOSEN PEMBIMBING  
**DYAH HENDRAWATI, ST., MSc.**

DOSEN PENGUJ  
**HANDYOTOMO Ir., MSA.**

JUDUL GAMBAR DRAWING TITLE

GAMBAR OLEH DRAWING BY  
**MUHAMMAD EDY PRATAMA SURYA**

STATUS STATUS  
**SITUASI**

SKALA SCALE  
**1:71,40**

BENANG NO. FILE NO.  
 NAME SIGN DATE

DRAWN BY

CHECKED BY

Reviewed & Approved by

GAMBAR NO. DRAWING NO.

POSITION NO. TITLE COPYRIGHT OR ARCHITECTURE 2019

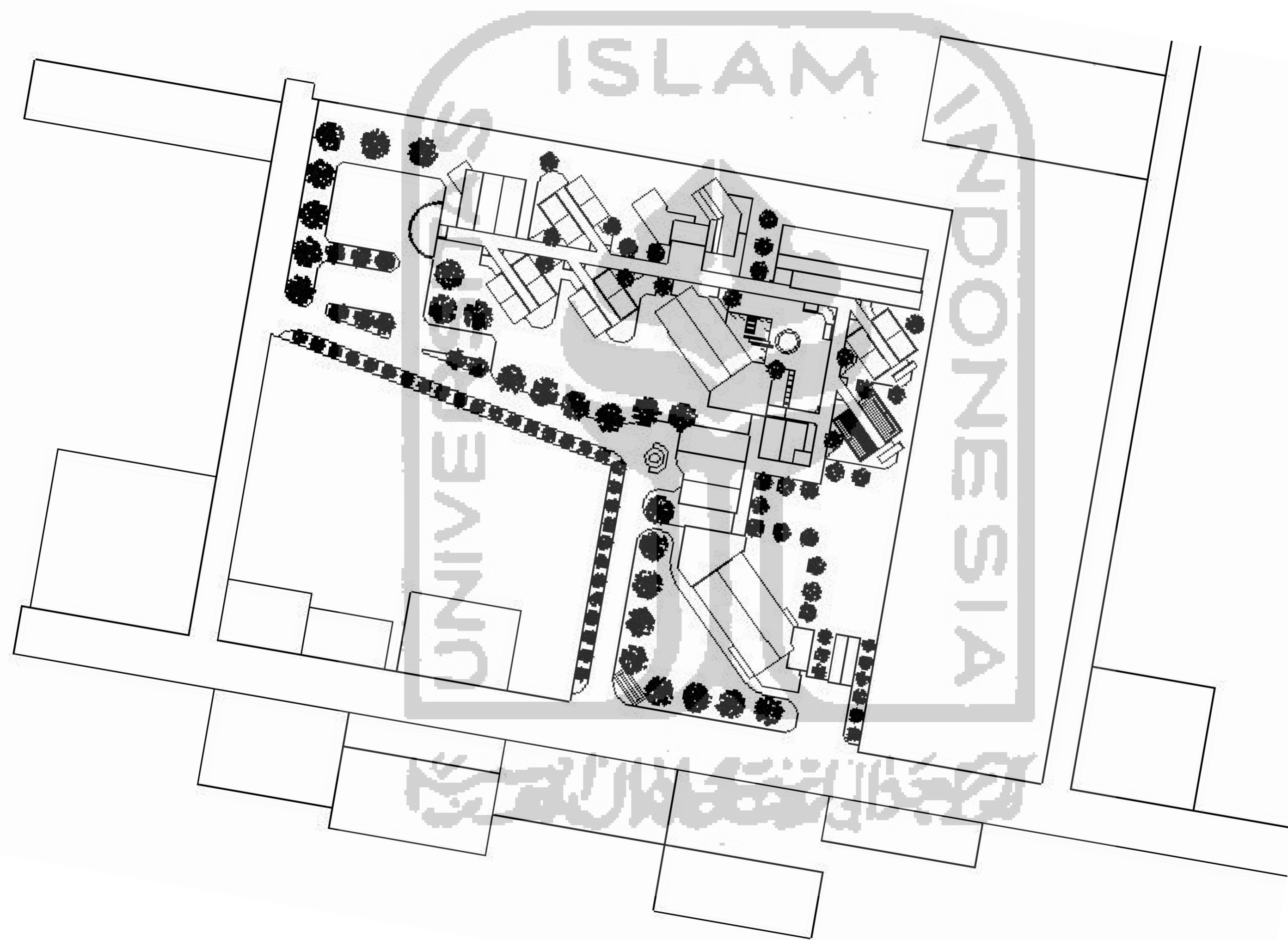

**CATATAN**  
 THESE DRAWINGS ARE AN INSTRUMENT OF SERVICE AND ARE THE PROPERTY OF THE CREATOR. ANY USE OF THE DRAWINGS WITHOUT THE PRIOR EXPRESS WRITTEN PERMISSION OF THE CREATOR IS A VIOLATION OF COPYRIGHT AND WILL BE LIABLE TO PROSECUTION. DO NOT SCALE FROM DRAWINGS. USE ONLY GIVEN DIMENSIONS. ALL DIMENSIONS ARE IN MILLIMETRES UNLESS OTHERWISE NOTED.

**PERSETUJUAN**  
 APPROVAL

**DYAH HENDRAWATI, ST., MSc.**

△			
△			
△			
△			
REV	DATE	REVISION STATUS	SIGN

PROJEK  
 PROJECT

**PERANCANGAN PUSAT TERAPI & KESEHATAN KHUSUS ANAK AUTIS**

INSTITUSI  
 INSTITUTION

JURUSAN SARJANA ARSITEKTUR  
 FAKULTAS TEKNIK DAN PERENCANAAN  
 UNIVERSITAS ISLAM INDONESIA



NAMA  
 NAME

**MUHAMMAD EDY PRATAMA SURYA**

NOMOR INDIK  
 MAHASISWA

**155121095**

DOSEN PEMBIMBING

**DYAH HENDRAWATI, ST., MSc.**

DOSEN PENGUJ

**HANDOYOTOMO Ir., MSA.**

JUDUL GAMBAR  
 DRAWING TITLE

GAMBAR OLEH  
 DRAWING BY

**MUHAMMAD EDY PRATAMA SURYA**

STATUS  
 STATUS

**SITUASI**

SKALA  
 SCALE

**1:71,40**

BENKAS  
 NO. FILE NO.

NAME SIGN DATE

DRAWN BY

CHECKED BY

Reviewed & Approved by

GAMBAR NO.  
 DRAWING NO.

POSITION NO. TITLE COPYRIGHT © ARCHITECTURE 2014

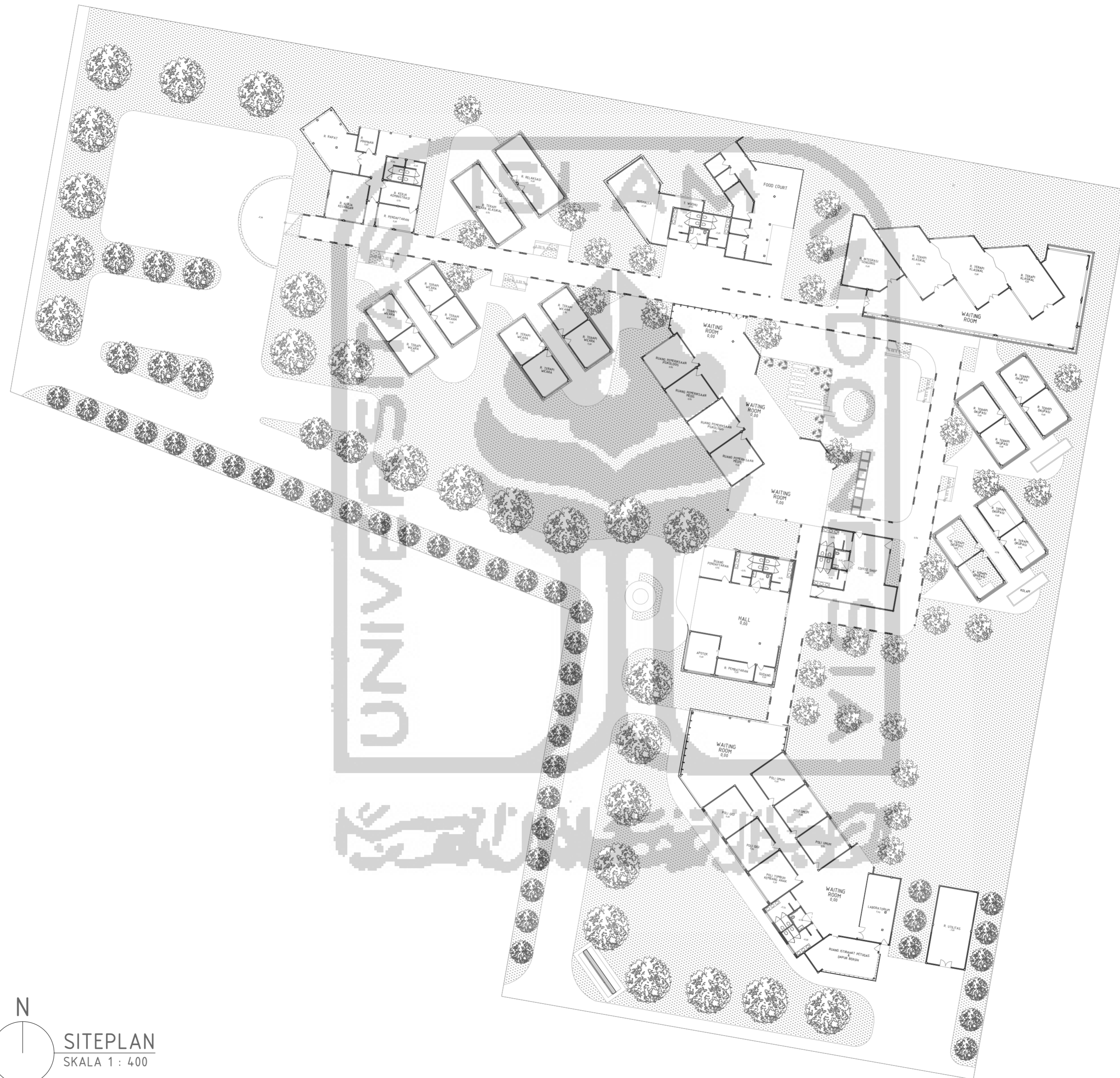

N  
 SITEPLAN  
 SKALA 1 : 400

**CATATAN**  
 THESE DRAWINGS ARE AN INSTRUMENT OF SERVICE AND ARE THE PROPERTY OF THE CREATOR. ANY USE OF THE DRAWINGS WITHOUT THE PRIOR EXPRESS WRITTEN PERMISSION OF THE CREATOR IS A VIOLATION OF COPYRIGHT AND WILL BE LIABLE TO PROSECUTION. DO NOT SCALE FROM DRAWINGS. USE ONLY GIVEN DIMENSIONS. ALL DIMENSIONS ARE IN MILLIMETRES UNLESS OTHERWISE NOTED.

PERSETUJUAN APPROVAL  
**DYAH HENDRAWATI, ST., MSc.**

REV	DATE	REVISION STATUS	SIGN

PROJEK PROJECT

**PERANCANGAN PUSAT TERAPI & KESEHATAN KHUSUS ANAK AUTIS**

INSTITUSI INSTITUTION  
 JURUSAN SARJANA ARSITEKTUR  
 FAKULTAS TEKNIK DAN PERENCANAAN  
 UNIVERSITAS ISLAM INDONESIA



NAMA NAME  
**MUHAMMAD EDY PRATAMA SURYA**  
 NO. INDUK MAHASISWA 155121095

DOSEN PEMBIMBING  
**DYAH HENDRAWATI, ST., MSc.**

DOSEN PENGUJ  
**HANDYOTOMO Ir., MSA.**

JUDUL GAMBAR DRAWING TITLE

GAMBAR OLEH DRAWING BY  
**MUHAMMAD EDY PRATAMA SURYA**

STATUS STATUS  
**SITEPLAN**

SKALA SCALE  
**1:400**

DRAWN BY  
 CHECKED BY  
 Reviewed & Approved by

GAMBAR NO. DRAWING NO.  
 POSISI NO. THIS  
 COPYRIGHT UIR ARCHITECTURE 2014



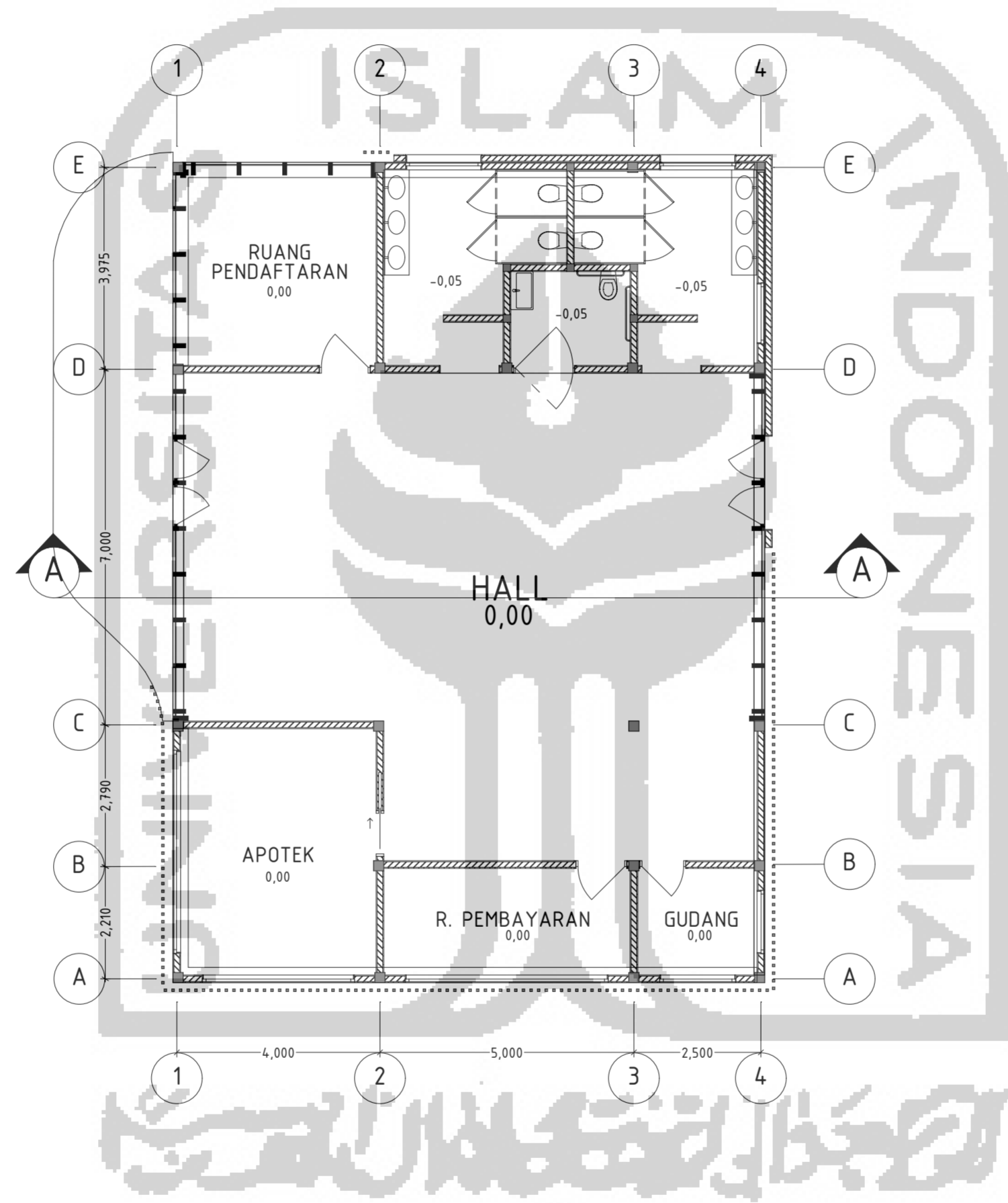

**DENAH PENUNJANG ENTRANCE**  
SKALA 1 : 100

**CATATAN**  
NOTES  
THESE DRAWINGS ARE AN INSTRUMENT OF SERVICE AND ARE THE PROPERTY OF THE CREATOR. ANY USE OF THE DRAWINGS WITHOUT THE PRIOR EXPRESS WRITTEN PERMISSION OF THE CREATOR IS A VIOLATION OF COPYRIGHT AND WILL BE LIABLE TO PROSECUTION. DO NOT SCALE FROM DRAWINGS. USE ONLY GIVEN DIMENSIONS. ALL DIMENSIONS ARE IN MILLIMETRES UNLESS OTHERWISE NOTED.

PERSETUJUAN APPROVAL

**DYAH HENDRAWATI, ST., MSc.**

REV	DATE	REVISION STATUS	SIGN

PROJEK PROJECT

**PERANCANGAN PUSAT TERAPI & KESEHATAN KHUSUS ANAK AUTIS**

INSTITUSI INSTITUTION  
JURUSAN SARJANA ARSITEKTUR  
FAKULTAS TEKNIK DAN PERENCANAAN  
UNIVERSITAS ISLAM INDONESIA



NAMA NAME  
MUHAMMAD EDY PRATAMA SURYA

NOMOR INDEK MAHASISWA  
155121095

DOSEN PEMBIMBING  
**DYAH HENDRAWATI, ST., MSc.**

DOSEN PENGUJ  
**HANDYOTOMO Ir., MSA.**

JUDUL GAMBAR DRAWING TITLE

GAMBAR OLEH DRAWING BY  
**MUHAMMAD EDY PRATAMA SURYA**

STATUS STATUS  
**DENAH PENUNJANG 01**

SKALA SCALE  
**1:100**

BENKAS NO. FILE NO.  
NAME SIGN DATE

DRAWN BY  
CHECKED BY

Reviewed & Approved by

GAMBAR NO. DRAWING NO.

POSITION NO. TIME COPYRIGHT © ARCHITECTURE 2019

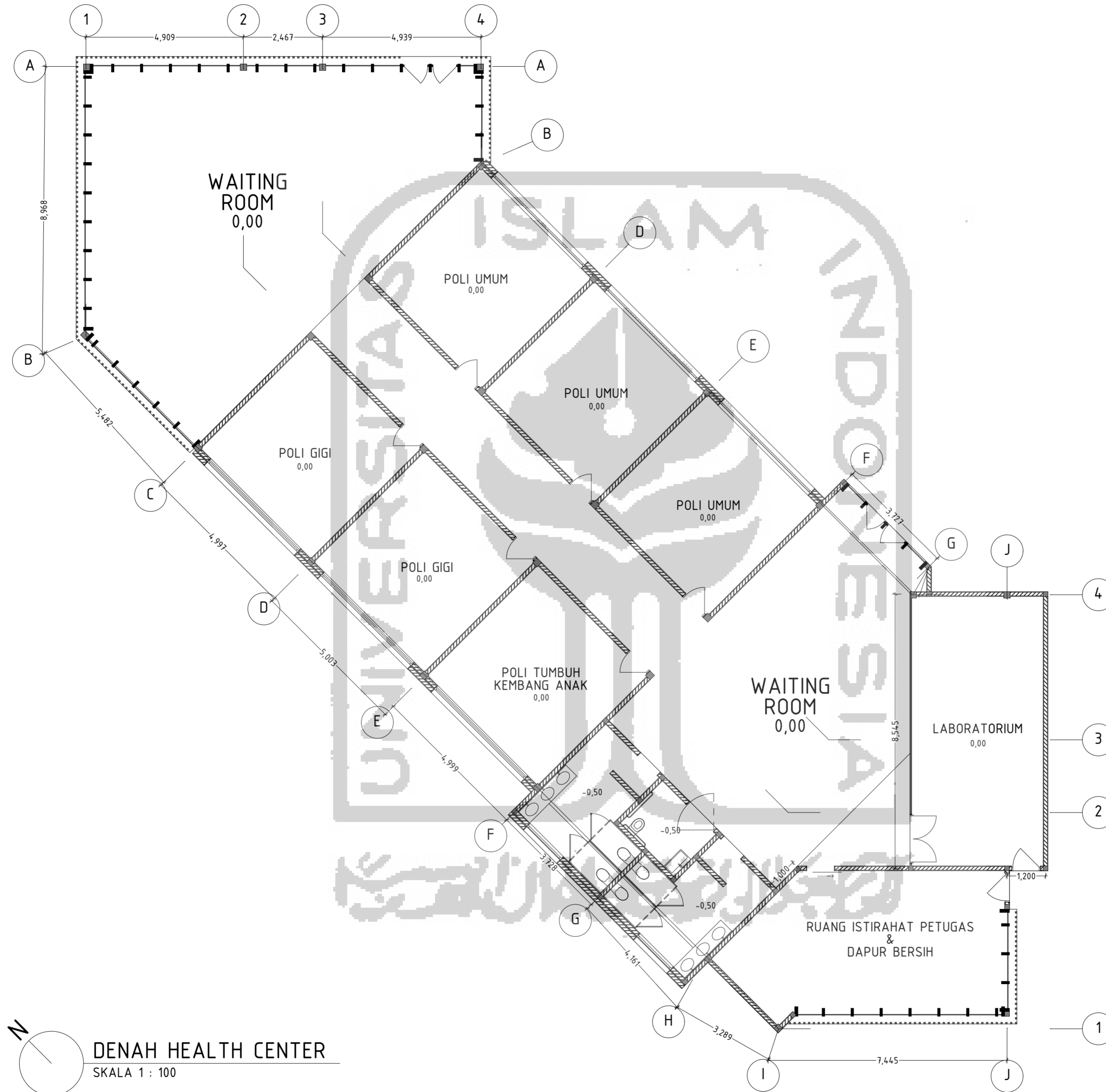

**DENAH HEALTH CENTER**  
SKALA 1 : 100

**CATATAN**  
THESE DRAWINGS ARE AN INSTRUMENT OF SERVICE AND ARE THE PROPERTY OF THE CREATOR. ANY USE OF THE DRAWINGS WITHOUT THE PRIOR EXPRESS WRITTEN PERMISSION OF THE CREATOR IS A VIOLATION OF COPYRIGHT AND WILL BE LIABLE TO PROSECUTION. DO NOT SCALE FROM DRAWINGS. USE ONLY GIVEN DIMENSIONS. ALL DIMENSIONS ARE IN MILLIMETRES UNLESS OTHERWISE NOTED.

PERSETUJUAN APPROVAL  
**DYAH HENDRAWATI, ST., MSc.**

REVISI	DATE	REVISION STATUS	SIGN

**PERANCANGAN PUSAT TERAPI & KESEHATAN KHUSUS ANAK AUTIS**

INSTITUSI  
JURUSAN SARJANA ARSITEKTUR  
FAKULTAS TEKNIK DAN PERENCANAAN  
UNIVERSITAS ISLAM INDONESIA



NAMA  
**MUHAMMAD EDY PRATAMA SURYA**  
NOMOR INDEK MAHASISWA  
**155121095**

DOSEN PEMBIMBING  
**DYAH HENDRAWATI, ST., MSc.**

DOSEN PENGUJ  
**HANDOYOTOMO Ir., MSA.**

JUDUL GAMBAR  
DRAWING TITLE

GAMBAR OLEH  
DRAWING BY  
**MUHAMMAD EDY PRATAMA SURYA**

STATUS  
STATUS  
**DENAH HEALTH CENTER**

SKALA  
SCALE  
**1:100**

DRAWN BY  
CHECKED BY  
Reviewed & Approved by

GAMBAR NO.  
DRAWING NO.  
POSITION NO.      TIME      COPYRIGHT © ARCHITECTURE 2019

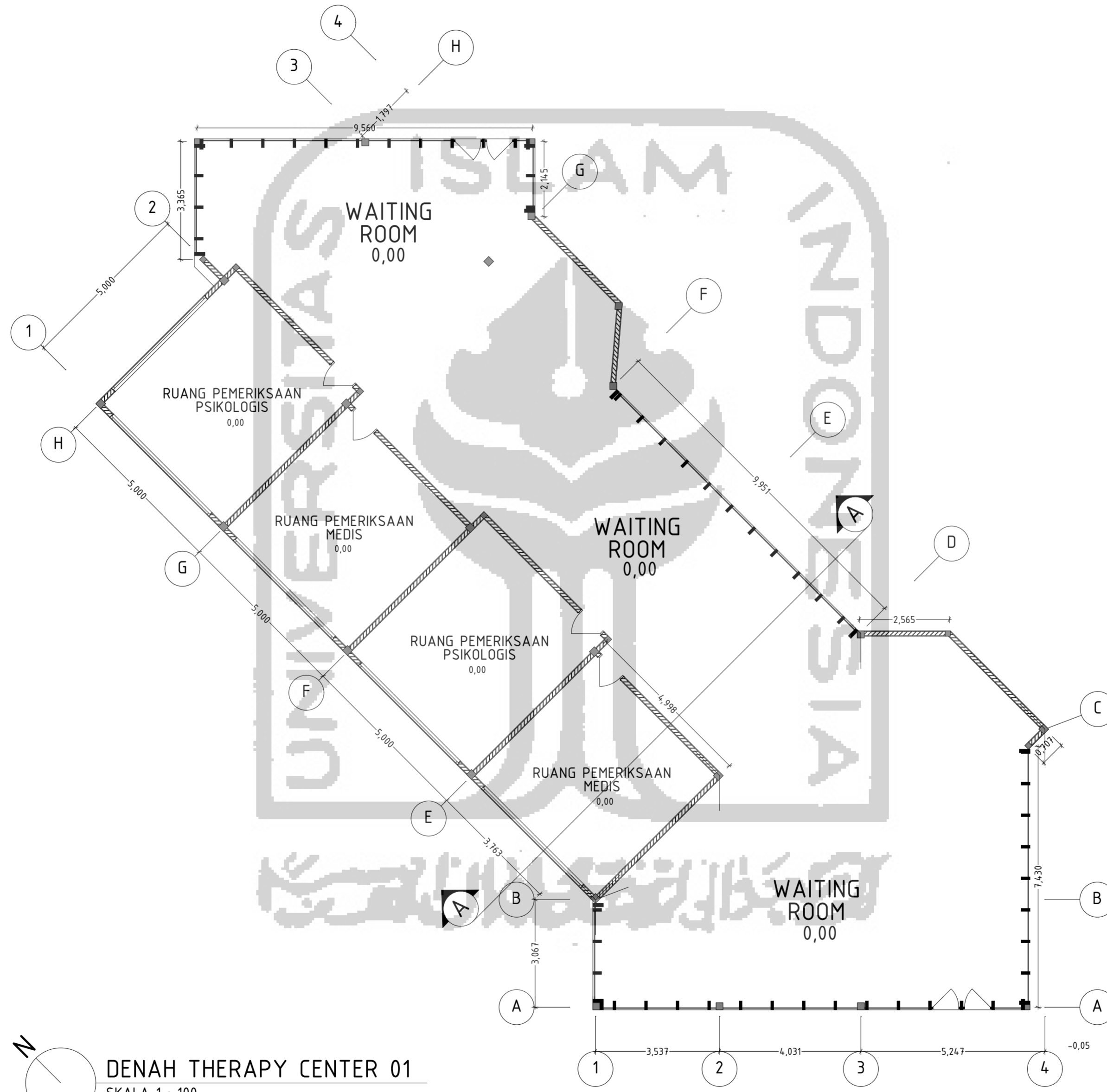

**DENAH THERAPY CENTER 01**  
 SKALA 1 : 100

**CATATAN**  
 THESE DRAWINGS ARE AN INSTRUMENT OF SERVICE AND ARE THE PROPERTY OF THE CREATOR. ANY USE OF THE DRAWINGS WITHOUT THE PRIOR EXPRESS WRITTEN PERMISSION OF THE CREATOR IS A VIOLATION OF COPYRIGHT AND WILL BE LIABLE TO PROSECUTION. DO NOT SCALE FROM DRAWINGS. USE ONLY GIVEN DIMENSIONS. ALL DIMENSIONS ARE IN MILLIMETRES UNLESS OTHERWISE NOTED.

PERSETUJUAN APPROVAL

**DYAH HENDRAWATI, ST., MSc.**

REVISI	DATE	REVISION STATUS	SIGN

PROJEK PROJECT

**PERANCANGAN PUSAT TERAPI & KESEHATAN KHUSUS ANAK AUTIS**

INSTITUSI INSTITUTION	
JURUSAN SARJANA ARSITEKTUR FAKULTAS TEKNIK DAN PERENCANAAN UNIVERSITAS ISLAM INDONESIA	
NAMA NAME	NOMOR INDEK MAHASISWA 155121095
<b>MUHAMMAD EDY PRATAMA SURYA</b>	
DOSEN PEMBIMBING	<b>DYAH HENDRAWATI, ST., MSc.</b>
DOSEN PENGUJ	<b>HANDOYOTOMO Ir., MSA.</b>
JUDUL GAMBAR DRAWING TITLE	

GAMBAR OLEH DRAWING BY	<b>MUHAMMAD EDY PRATAMA SURYA</b>		
STATUS STATUS	<b>DENAH THERAPY CENTER 01</b>		
SKALA SCALE	<b>1:100</b>	BERKAS NO. FILE NO.	
DRAWN BY	NAME	SIGN	DATE
CHECKED BY			
Reviewed & Approved by			
GAMBAR NO. DRAWING NO.			

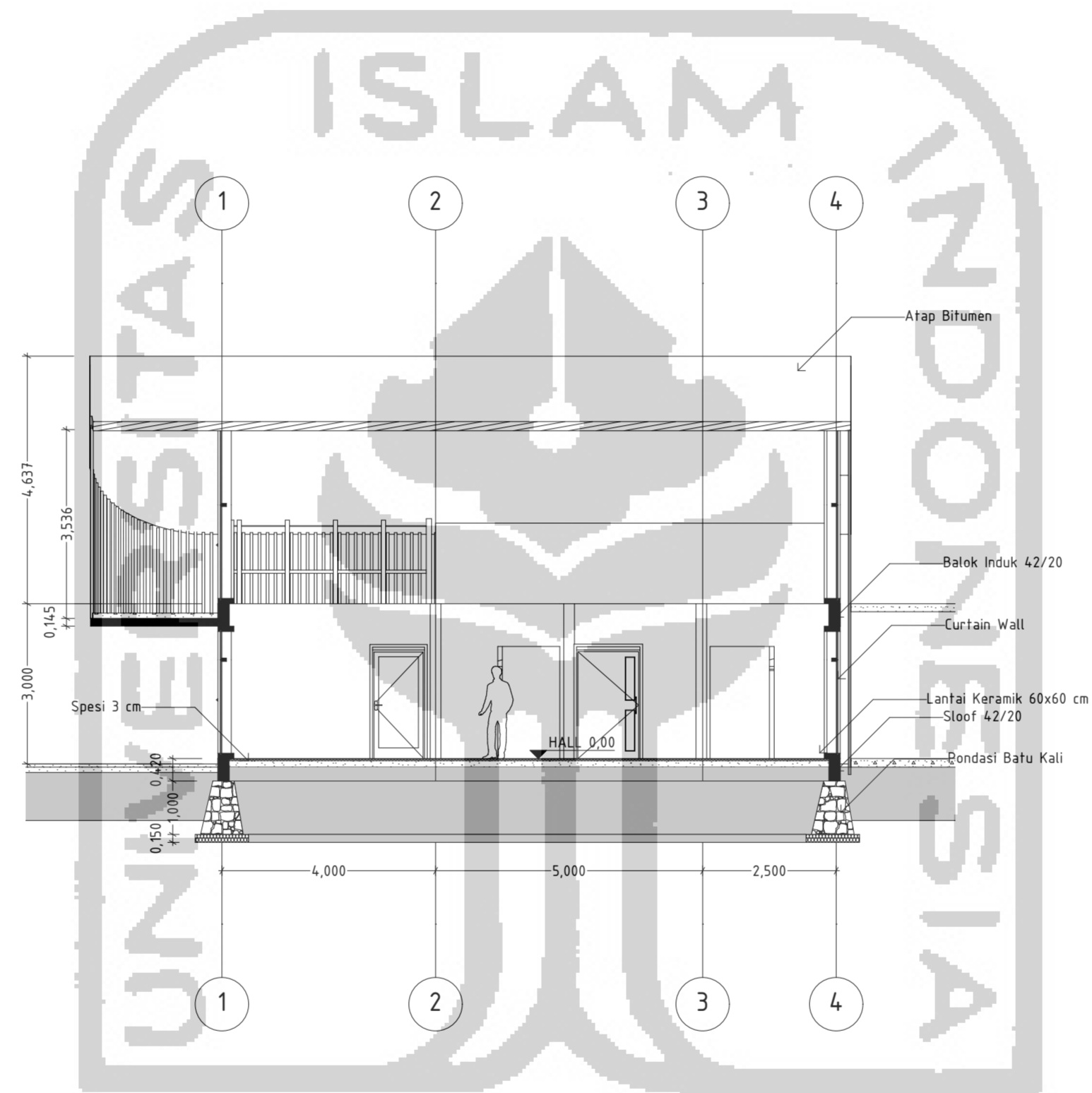

**POTONGAN A-A PENUNJANG ENTRANCE**  
 SKALA 1 : 100

**CATATAN**  
 THESE DRAWINGS ARE AN INSTRUMENT OF SERVICE AND ARE THE PROPERTY OF THE CREATOR. ANY USE OF THE DRAWINGS WITHOUT THE PRIOR EXPRESS WRITTEN PERMISSION OF THE CREATOR IS A VIOLATION OF COPYRIGHT AND WILL BE LIABLE TO PROSECUTION. DO NOT SCALE FROM DRAWINGS. USE ONLY GIVEN DIMENSIONS. ALL DIMENSIONS ARE IN MILLIMETRES UNLESS OTHERWISE NOTED.

PERSETUJUAN APPROVAL  
**DYAH HENDRAWATI, ST., MSc.**

△			
△			
△			
△			
REV	DATE	REVISION STATUS	SIGN

PROJEK PROJECT  
**PERANCANGAN PUSAT TERAPI & KESEHATAN KHUSUS ANAK AUTIS**

INSTITUSI INSTITUTION  
**JURUSAN SARJANA ARSITEKTUR  
 FAKULTAS TEKNIK DAN PERENCANAAN  
 UNIVERSITAS ISLAM INDONESIA**

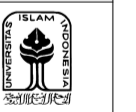

NAMA NAME  
**MUHAMMAD EDY PRATAMA SURYA**

NOMOR INDEK MAHASISWA  
**155121095**

DOSEN PEMBIMBING  
**DYAH HENDRAWATI, ST., MSc.**

DOSEN PENGUJI  
**HANDYOTOMO Ir., MSA.**

JUDUL GAMBAR DRAWING TITLE  
**POTONGAN A-A PENUNJANG ENTRANCE**

GAMBAR OLEH DRAWING BY  
**MUHAMMAD EDY PRATAMA SURYA**

STATUS STATUS  
**POTONGAN A-A PENUNJANG ENTRANCE**

SKALA SCALE  
**1:100**

BERKAS NO. FILE NO.  
 NAME SIGN DATE

DRAWN BY

CHECKED BY

Reviewed & Approved by

GAMBAR NO. DRAWING NO.

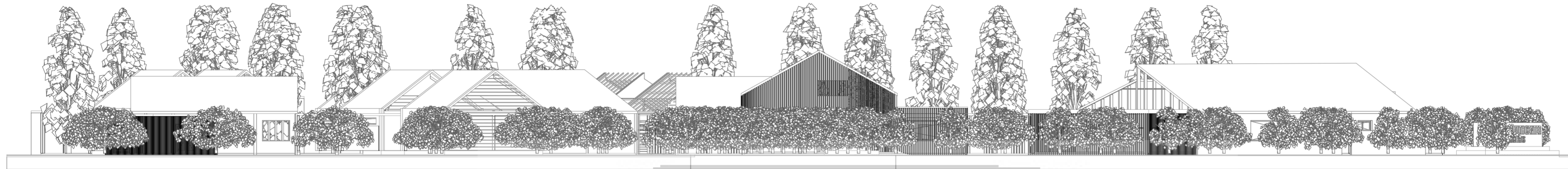

TAMPAK BARAT  
SKALA 1 : 250



TAMPAK UTARA  
SKALA 1 : 250

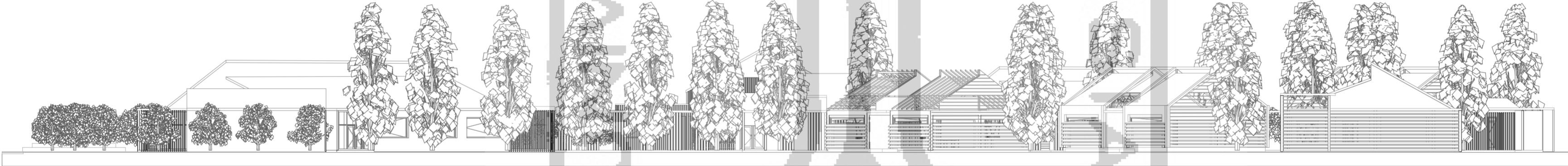

TAMPAK TIMUR  
SKALA 1 : 250



TAMPAK SELATAN  
SKALA 1 : 250



**CATATAN**  
THESE DRAWINGS ARE AN INSTRUMENT OF SERVICE AND ARE THE PROPERTY OF THE CREATOR. ANY USE OF THE DRAWINGS WITHOUT THE PRIOR EXPRESS WRITTEN PERMISSION OF THE CREATOR IS A VIOLATION OF COPYRIGHT AND WILL BE LIABLE TO PROSECUTION. DO NOT SCALE FROM DRAWINGS. USE ONLY GIVEN DIMENSIONS. ALL DIMENSIONS ARE IN MILLIMETRES UNLESS OTHERWISE NOTED.

PERSETUJUAN APPROVAL  
**DYAH HENDRAWATI, ST., MSc.**

REVISION	DATE	REVISION STATUS	SIGN

PROJEK PROJECT  
**PERANCANGAN PUSAT TERAPI & KESEHATAN KHUSUS ANAK AUTIS**

INSTITUSI INSTITUTION  
JURUSAN SARJANA ARSITEKTUR  
FAKULTAS TEKNIK DAN PERENCANAAN  
UNIVERSITAS ISLAM INDONESIA



NAMA NAME  
**MUHAMMAD EDY PRATAMA SURYA**

NOMOR INDEK MAHASISWA  
155121095

DOSEN PEMBIMBING  
**DYAH HENDRAWATI, ST., MSc.**

DOSEN PENGUJ  
**HANDOYOTOMO Ir., MSA.**

JUDUL GAMBAR DRAWING TITLE  
**TAMPAK KAWASAN**

GAMBAR OLEH DRAWING BY  
**MUHAMMAD EDY PRATAMA SURYA**

STATUS STATUS  
SKALA SCALE  
**1:250**

BERKAS NO. FILE NO.  
DRAWN BY  
CHECKED BY  
Reviewed & Approved by

GAMBAR NO. DRAWING NO.  
POSITION NO. TITLE COPYRIGHT UII ARCHITECTURE 2014

**DENAH TERAPI WICARA**  
SKALA 1 : 100

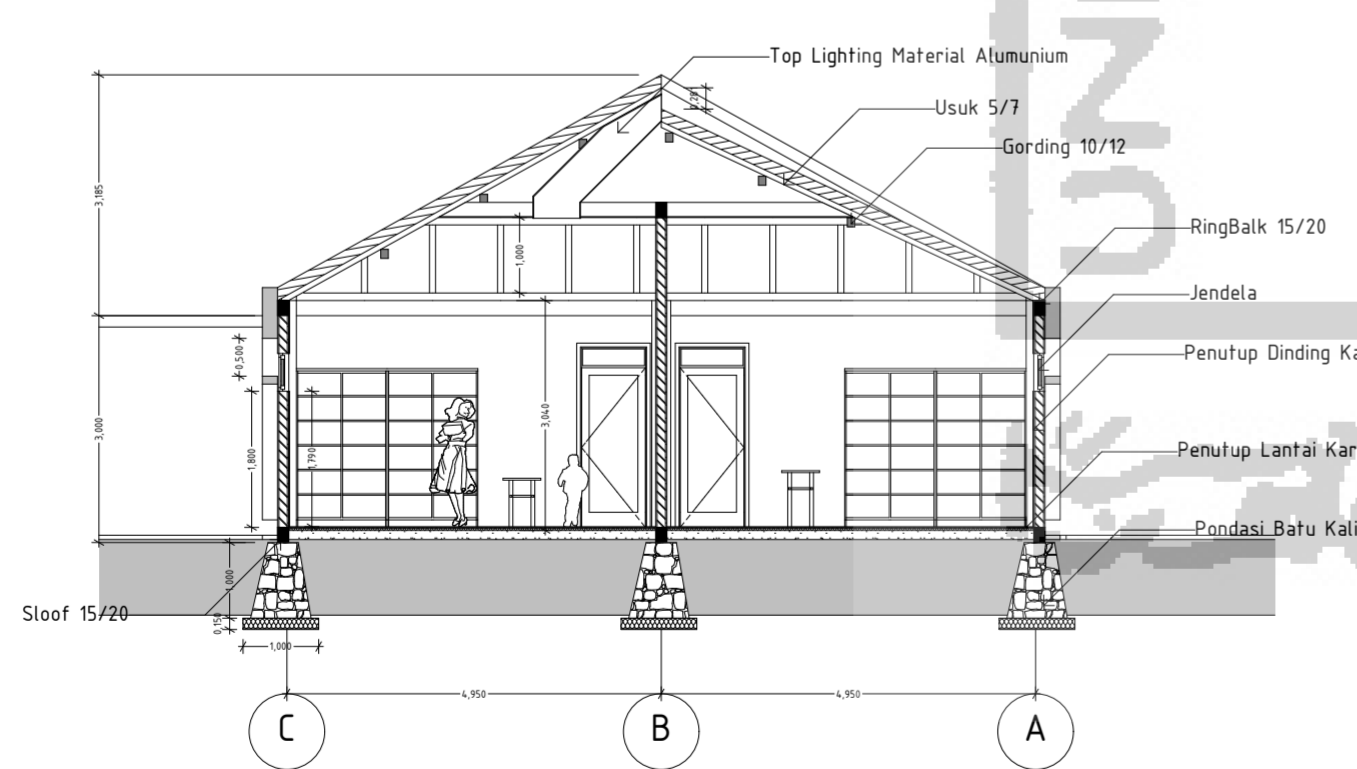
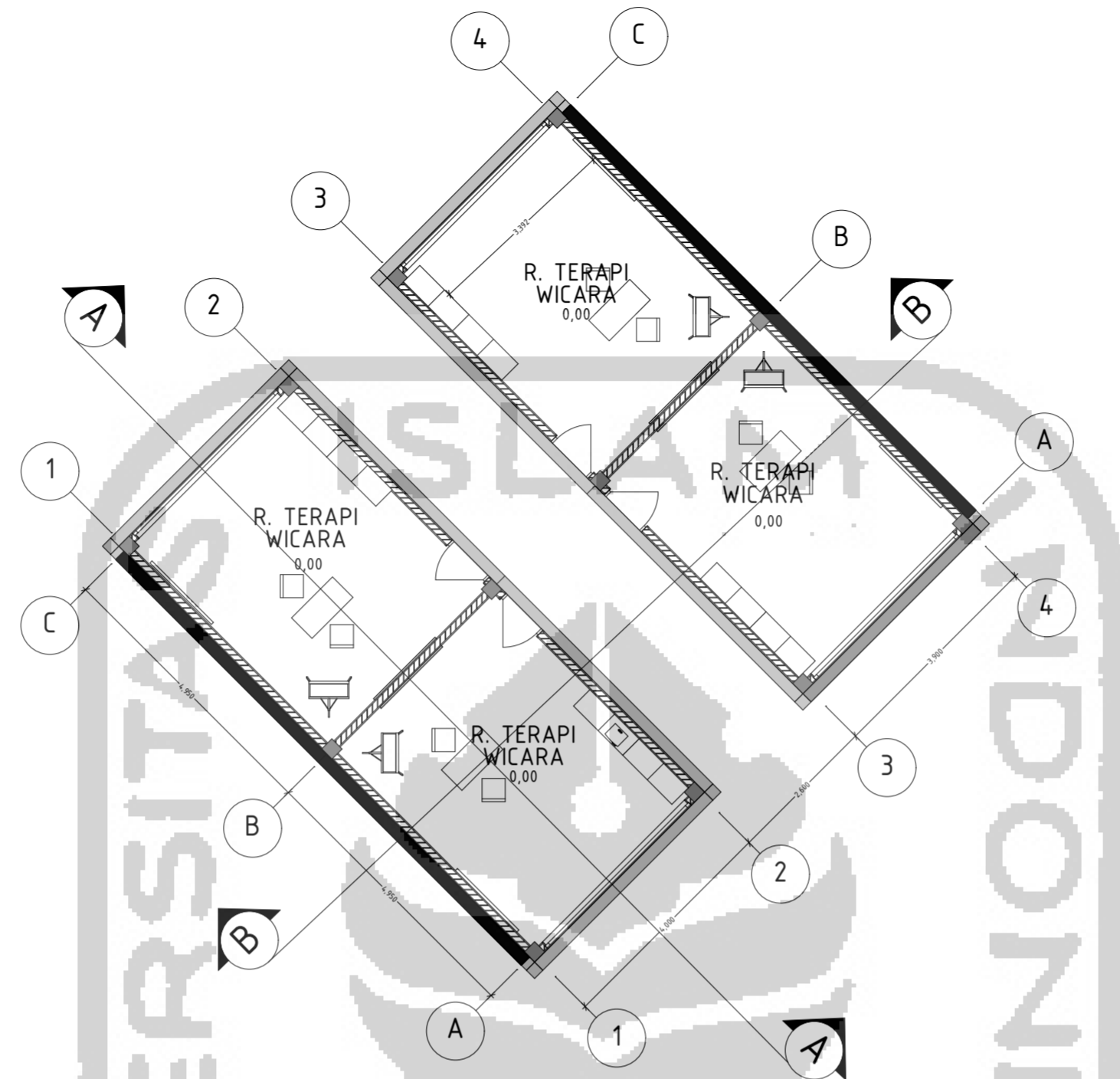

**POTONGAN A-A**  
SKALA 1 : 100

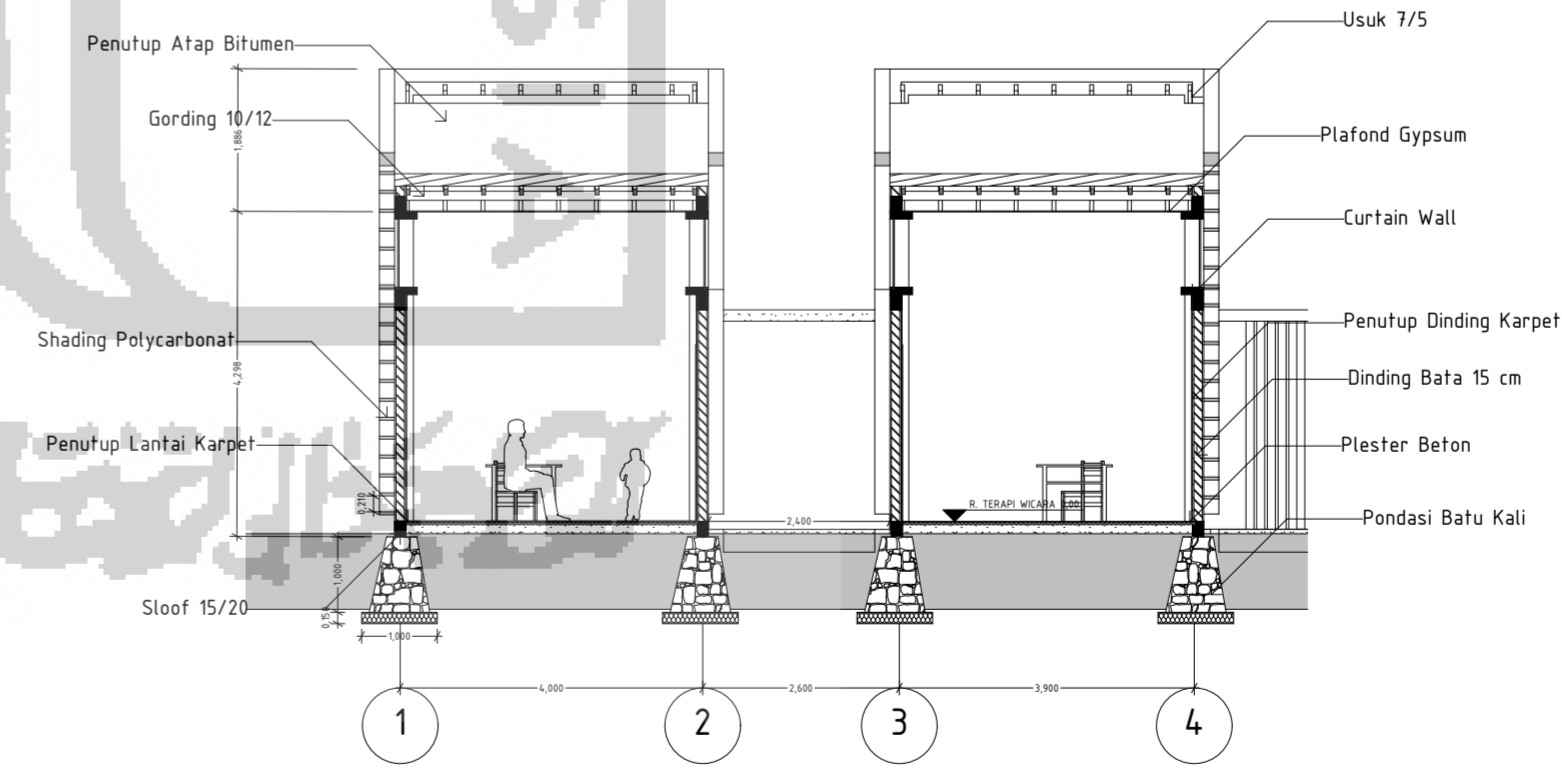

**POTONGAN B-B**  
SKALA 1 : 100

**CATATAN**  
THESE DRAWINGS ARE AN INSTRUMENT OF SERVICE AND ARE THE PROPERTY OF THE CREATOR. ANY USE OF THE DRAWINGS WITHOUT THE PRIOR EXPRESS WRITTEN PERMISSION OF THE CREATOR IS A VIOLATION OF COPYRIGHT AND WILL BE LIABLE TO PROSECUTION. DO NOT SCALE FROM DRAWINGS. USE ONLY GIVEN DIMENSIONS. ALL DIMENSIONS ARE IN MILLIMETRES UNLESS OTHERWISE NOTED.

PERSETUJUAN APPROVAL

**DYAH HENDRAWATI, ST., MSc.**

REVISI	DATE	REVISION STATUS	SIGN

PROJEK PROJECT

**PERANCANGAN PUSAT TERAPI & KESEHATAN KHUSUS ANAK AUTIS**

INSTITUSI INSTITUTION  
JURUSAN SARJANA ARSITEKTUR  
FAKULTAS TEKNIK DAN PERENCANAAN  
UNIVERSITAS ISLAM INDONESIA

NAMA NAME  
**MUHAMMAD EDY PRATAMA SURYA**  
NOMOR INDIK MAHASISWA  
155121095

DOSEN PEMBIMBING  
**DYAH HENDRAWATI, ST., MSc.**

DOSEN PENGUJI  
**HANDOYOTOMO Ir., MSA.**

JUDUL GAMBAR DRAWING TITLE  
**RUANG TERAPI WICARA & VISUAL**

GAMBAR OLEH DRAWING BY  
**MUHAMMAD EDY PRATAMA SURYA**

STATUS STATUS  
SKALA SCALE  
**1:100**  
BERKAS NO. FILE NO.

DRAWN BY  
CHECKED BY  
Reviewed & Approved by

GAMBAR NO. DRAWING NO.  
POSITION NO. TIME COPYRIGHT © ARCHITECTURE 2019

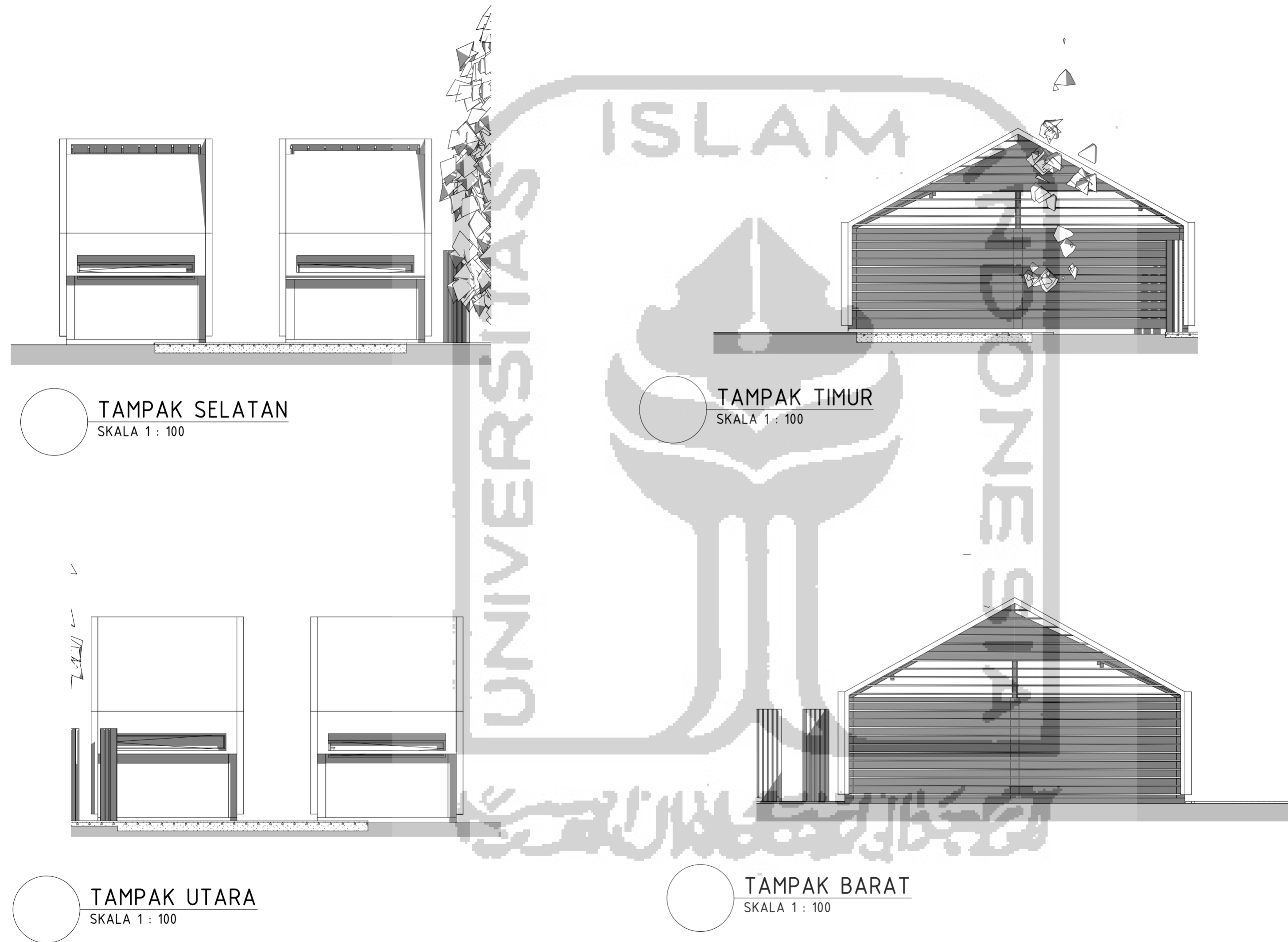

TAMPAK SELATAN  
SKALA 1 : 100

TAMPAK TIMUR  
SKALA 1 : 100

TAMPAK UTARA  
SKALA 1 : 100

TAMPAK BARAT  
SKALA 1 : 100

**CATATAN**  
THESE DRAWINGS ARE AN INSTRUMENT OF SERVICE AND ARE THE PROPERTY OF THE CREATOR. ANY USE OF THE DRAWINGS WITHOUT THE PRIOR EXPRESS WRITTEN PERMISSION OF THE CREATOR IS A VIOLATION OF COPYRIGHT AND WILL BE LIABLE TO PROSECUTION. DO NOT SCALE FROM DRAWINGS. USE ONLY GIVEN DIMENSIONS. ALL DIMENSIONS ARE IN MILLIMETRES UNLESS OTHERWISE NOTED.

**PERSETUJUAN**  
APPROVAL

**DYAH HENDRAWATI, ST., MSc.**

REVISION	DATE	REVISION STATUS	SIGN

PROYEK / PROJECT

**PERANCANGAN PUSAT TERAPI & KESEHATAN KHUSUS ANAK AUTIS**

INSTITUSI / INSTITUTION  
JURUSAN SARJANA ARSITEKTUR  
FAKULTAS TEKNIK DAN PERENCANAAN  
UNIVERSITAS ISLAM INDONESIA



NAMA / NAME  
**MUHAMMAD EDY PRATAMA SURYA**

NOMOR INDEK / MAHASISWA  
155121095

DOSEN PEMBIMBING  
**DYAH HENDRAWATI, ST., MSc.**

DOSEN PENGUJI  
**HANDYOTOMO Ir., MSA.**

JUDUL GAMBAR / DRAWING TITLE

GAMBAR OLEH / DRAWING BY  
**MUHAMMAD EDY PRATAMA SURYA**

STATUS / STATUS

SKALA / SCALE: **1:100**

BENKAS NO. / FILE NO.

DRAWN BY

CHECKED BY

Reviewed & Approved by

GAMBAR NO. / DRAWING NO.

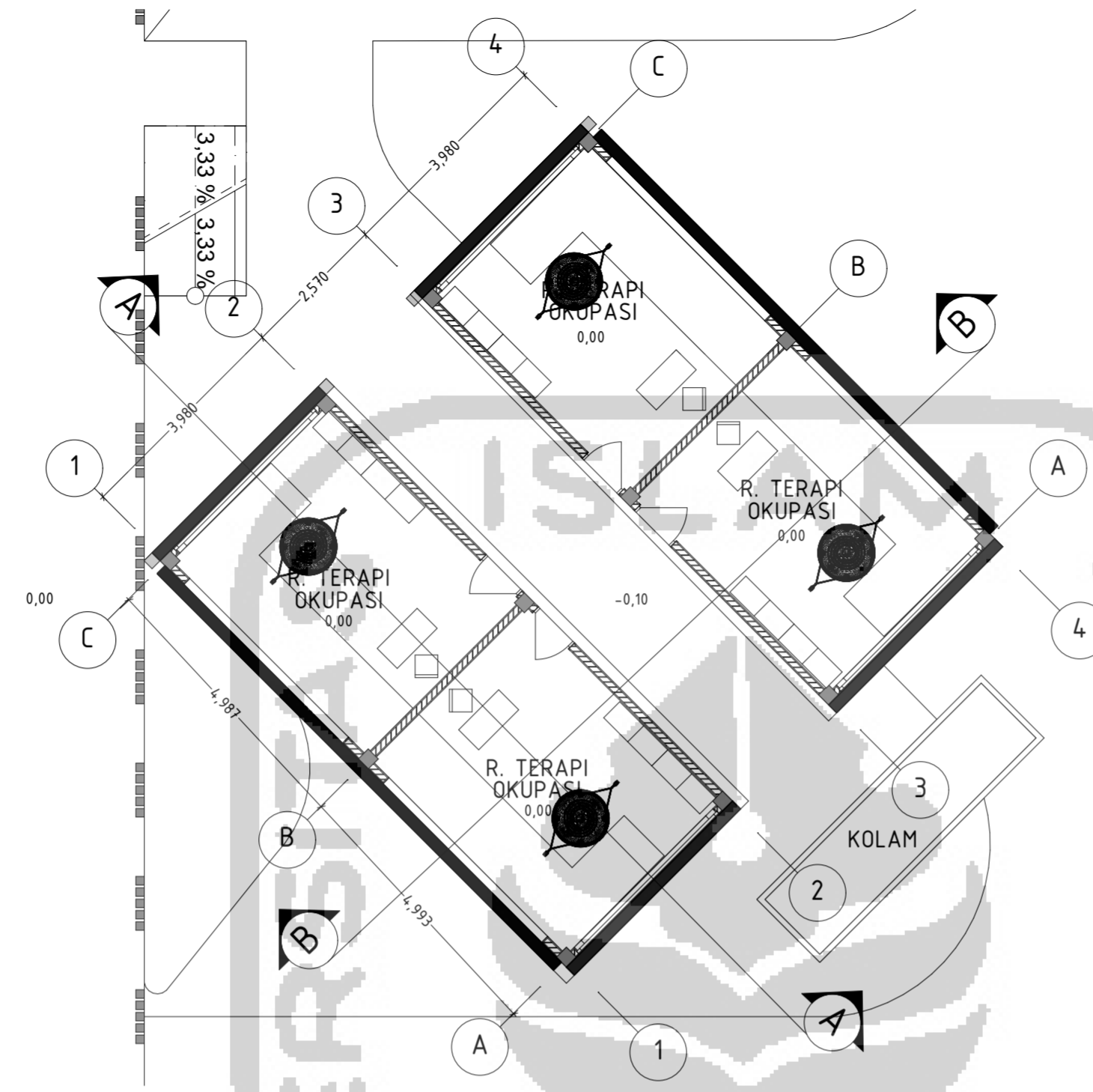

**DENAH TERAPI OKUPASI**  
SKALA 1 : 100

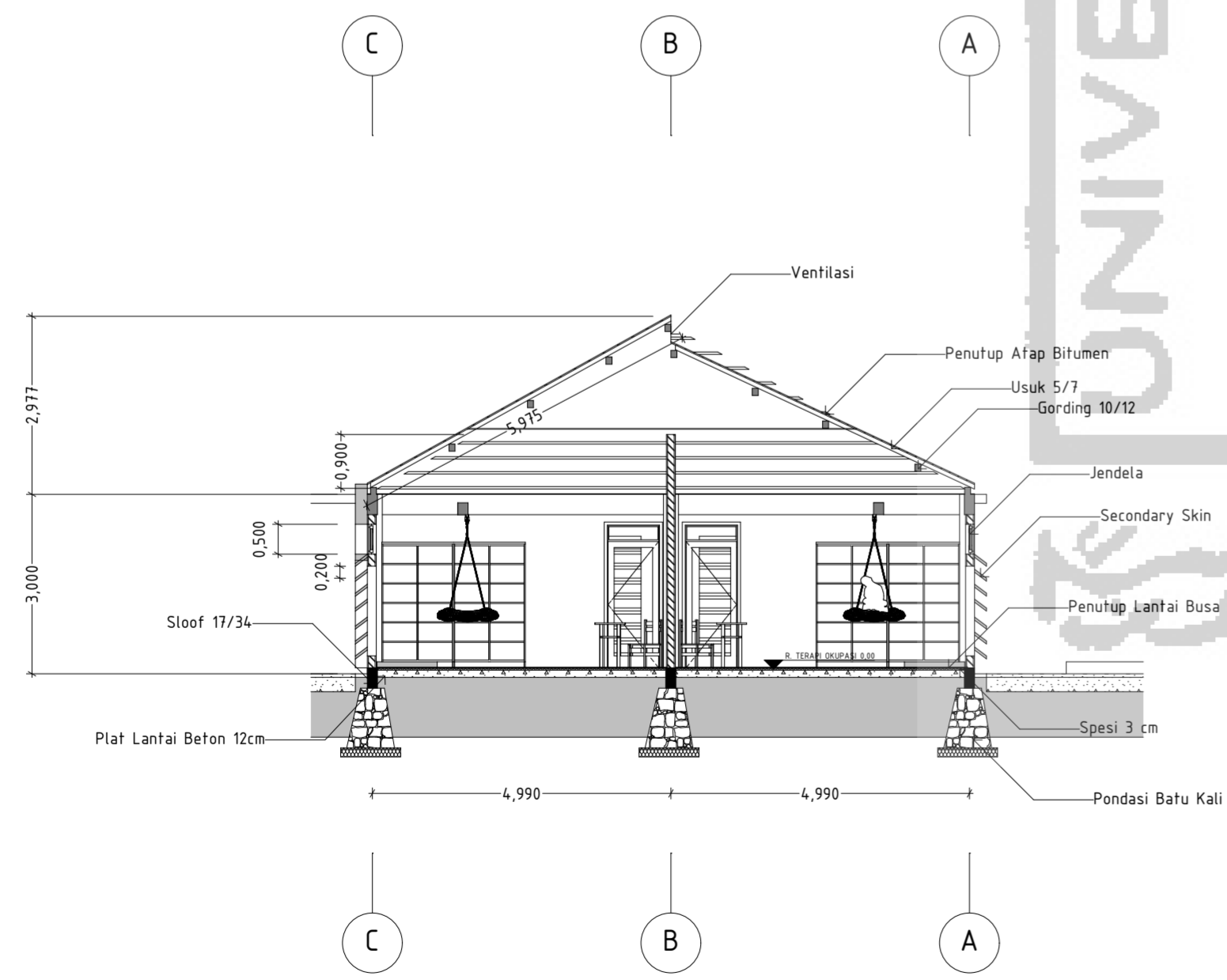

**POTONGAN A-A**  
SKALA 1 : 100

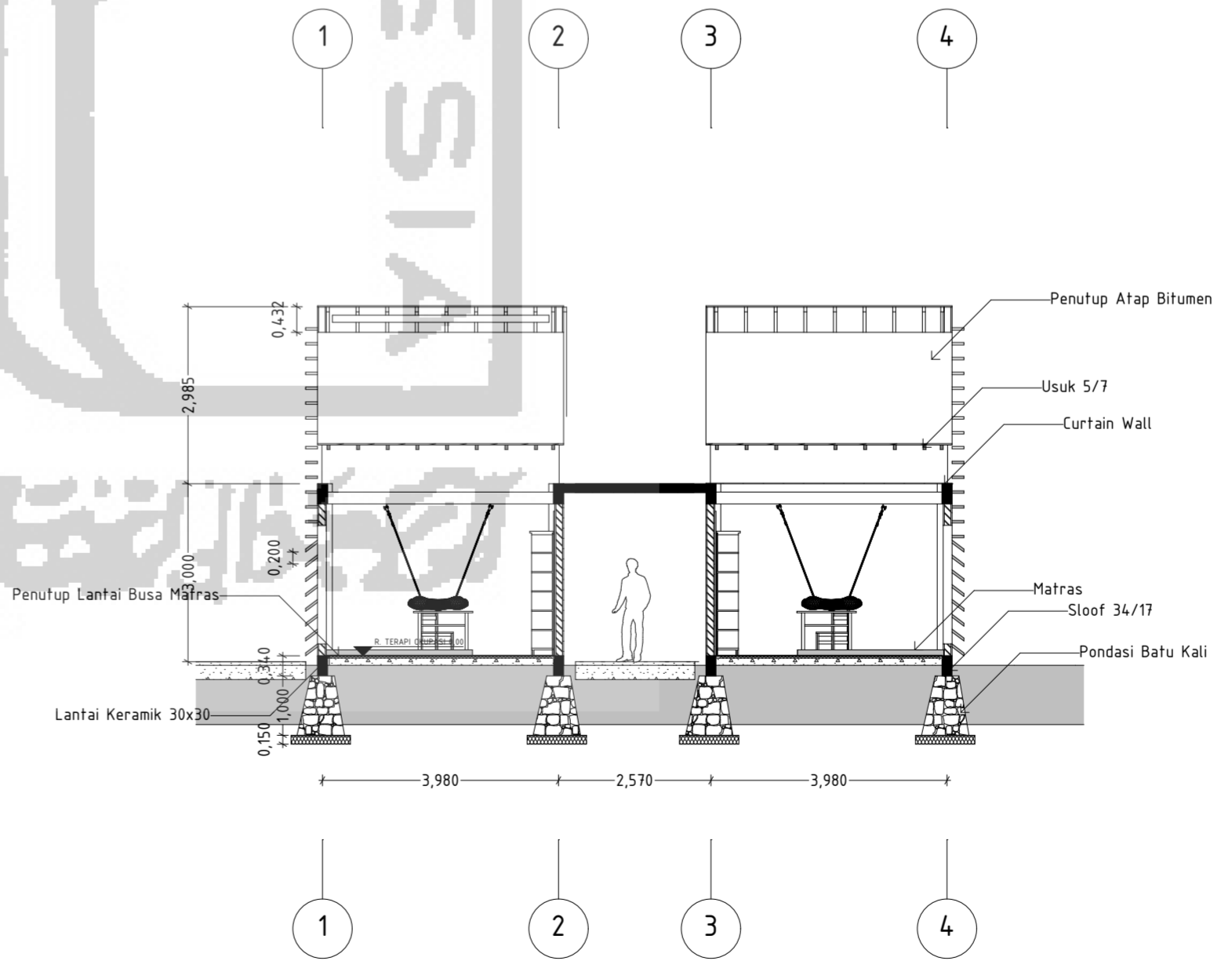

**POTONGAN B-B**  
SKALA 1 : 100

**NOTES**  
THESE DRAWINGS ARE AN INSTRUMENT OF SERVICE AND ARE THE PROPERTY OF THE CREATOR. ANY USE OF THE DRAWINGS WITHOUT THE PRIOR EXPRESS WRITTEN PERMISSION OF THE CREATOR IS A VIOLATION OF COPYRIGHT AND WILL BE LIABLE TO PROSECUTION. DO NOT SCALE FROM DRAWINGS. USE ONLY GIVEN DIMENSIONS. ALL DIMENSIONS ARE IN MILLIMETRES UNLESS OTHERWISE NOTED.

**PERSETUJUAN APPROVAL**  
**DYAH HENDRAWATI, ST., MSc.**

REV	DATE	REVISION STATUS	SIGN

**PERANCANGAN PUSAT TERAPI & KESEHATAN KHUSUS ANAK AUTIS**

INSTITUSI  
JURUSAN SARJANA ARSITEKTUR  
FAKULTAS TEKNIK DAN PERENCANAAN  
UNIVERSITAS ISLAM INDONESIA

NAMA  
**MUHAMMAD EDY PRATAMA SURYA**  
NOMOR INDIK  
MAHASISWA  
155121095

DOSEN PEMBIMBING  
**DYAH HENDRAWATI, ST., MSc.**

DOSEN PENGUJ  
**HANDOYOTOMO Ir., MSA.**

JUDUL GAMBAR  
**RUANG TERAPI OKUPASI**  
DRAWING TITLE

GAMBAR OLEH  
DRAWING BY  
**MUHAMMAD EDY PRATAMA SURYA**

STATUS  
STATUS

SKALA  
SCALE  
**1:100**

DRAWN BY  
CHECKED BY  
Reviewed & Approved by

GAMBAR NO.  
DRAWING NO.



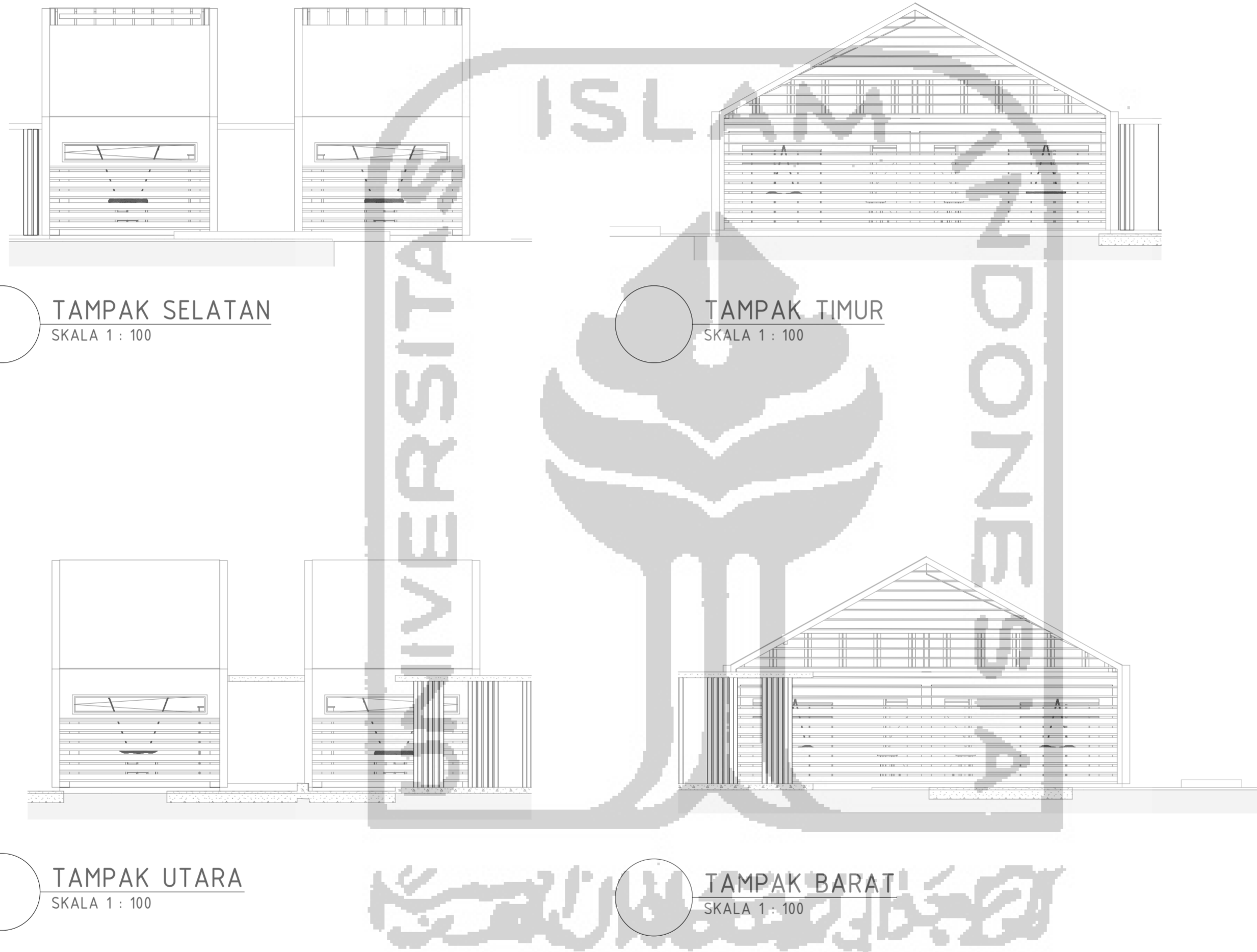

TAMPAK SELATAN  
SKALA 1 : 100

TAMPAK TIMUR  
SKALA 1 : 100

TAMPAK UTARA  
SKALA 1 : 100

TAMPAK BARAT  
SKALA 1 : 100

**CATATAN**  
 THESE DRAWINGS ARE AN INSTRUMENT OF SERVICE AND ARE THE PROPERTY OF THE CREATOR. ANY USE OF THE DRAWINGS WITHOUT THE PRIOR EXPRESS WRITTEN PERMISSION OF THE CREATOR IS A VIOLATION OF COPYRIGHT AND WILL BE LIABLE TO PROSECUTION. DO NOT SCALE FROM DRAWINGS. USE ONLY GIVEN DIMENSIONS. ALL DIMENSIONS ARE IN MILLIMETRES UNLESS OTHERWISE NOTED.

PERSETUJUAN APPROVAL  
**DYAH HENDRAWATI, ST., MSc.**

REVISI	DATE	REVISION STATUS	SIGN
△			
△			
△			

PROJEK PROJECT

**PERANCANGAN PUSAT TERAPI & KESEHATAN KHUSUS ANAK AUTIS**

INSTITUSI INSTITUTION  
 JURUSAN SARJANA ARSITEKTUR FAKULTAS TEKNIK DAN PERENCANAAN UNIVERSITAS ISLAM INDONESIA

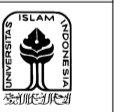

NAMA NAME  
**MUHAMMAD EDY PRATAMA SURYA**

NOMOR INDEK MAHASISWA  
 155121095

DOSEN PEMBIMBING  
**DYAH HENDRAWATI, ST., MSc.**

DOSEN PENGUJ  
**HANDYOTOMO Ir., MSA.**

JUDUL GAMBAR DRAWING TITLE  
**TAMPAK RUANG TERAPI OKUPASI**

GAMBAR OLEH DRAWING BY  
**MUHAMMAD EDY PRATAMA SURYA**

STATUS STATUS  
 SKALA SCALE **1:100** BERKAS NO. FILE NO.

DRAWN BY  
 CHECKED BY

Reviewed & Approved by  
 GAMBAR NO. DRAWING NO.

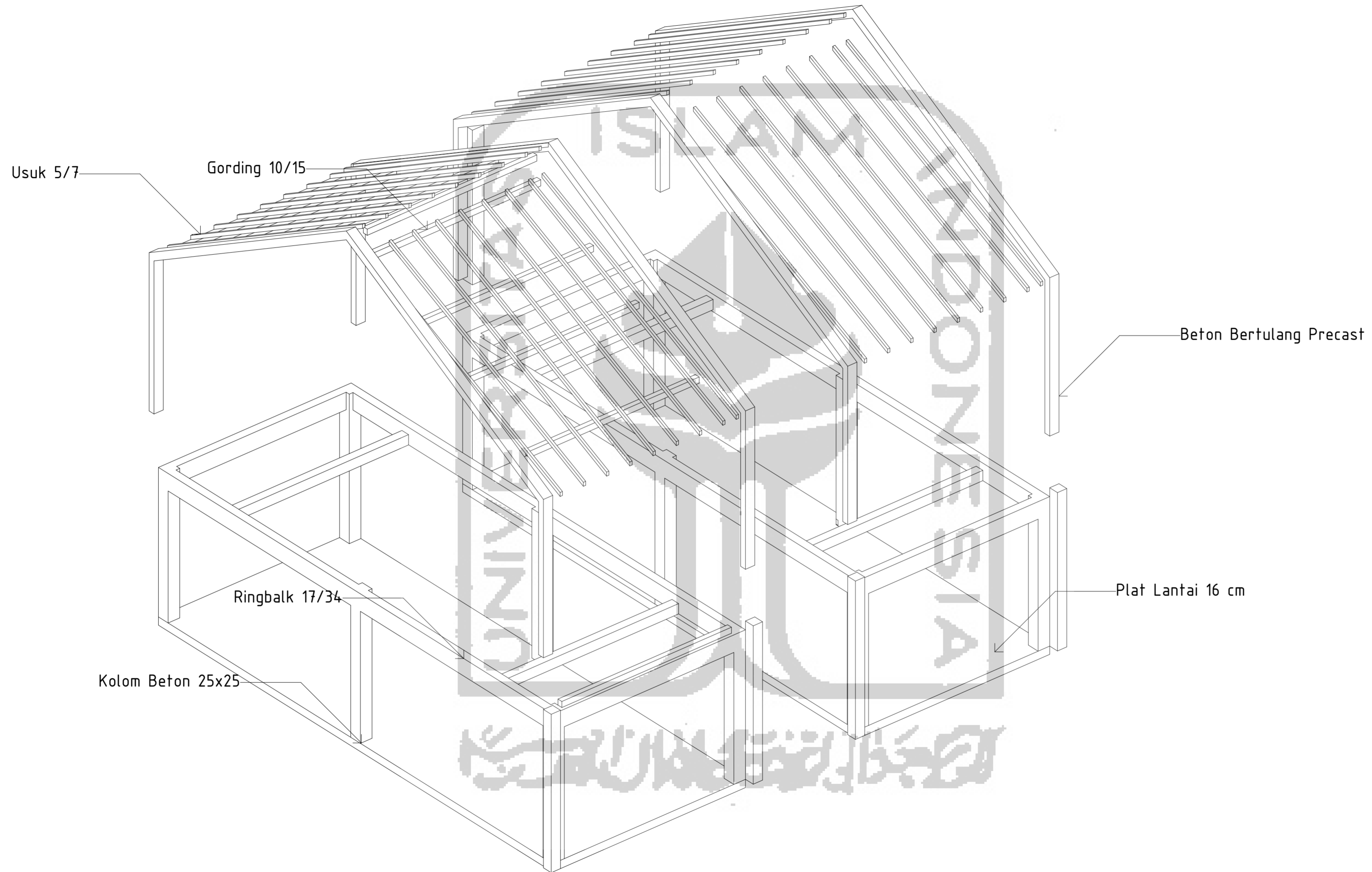

SKEMA STRUKTUR RUANG TERAPI OKUPASI

**CATATAN**  
 THESE DRAWINGS ARE AN INSTRUMENT OF SERVICE AND ARE THE PROPERTY OF THE CREATOR. ANY USE OF THE DRAWINGS WITHOUT THE PRIOR EXPRESS WRITTEN PERMISSION OF THE CREATOR IS A VIOLATION OF COPYRIGHT AND WILL BE LIABLE TO PROSECUTION. DO NOT SCALE FROM DRAWINGS. USE ONLY GIVEN DIMENSIONS. ALL DIMENSIONS ARE IN MILLIMETRES UNLESS OTHERWISE NOTED.

**PERSETUJUAN APPROVAL**  
 DYAH HENDRAWATI, ST., MSc.

△			
△			
△			
△			
REV	DATE	REVISION STATUS	SIGN

PROJEK PROJECT

**PERANCANGAN PUSAT TERAPI & KESEHATAN KHUSUS ANAK AUTIS**

INSTITUSI INSTITUTION  
 JURUSAN SARJANA ARSITEKTUR  
 FAKULTAS TEKNIK DAN PERENCANAAN  
 UNIVERSITAS ISLAM INDONESIA

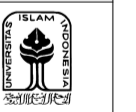

NAMA NAME  
**MUHAMMAD EDY PRATAMA SURYA**  
 NOMOR INDEK MAHASISWA 155121095

DOSEN PEMBIMBING  
**DYAH HENDRAWATI, ST., MSc.**

DOSEN PENGUJ  
**HANDYOTOMO Ir., MSA.**

JUDUL GAMBAR DRAWING TITLE

GAMBAR OLEH DRAWING BY  
**MUHAMMAD EDY PRATAMA SURYA**

STATUS STATUS  
**SKEMA STRUKTUR RUANG T. OKUPASI**

SKALA SCALE 1:50  
 BERKAS NO. FILE NO.  
 NAME SIGN DATE

DRAWN BY  
 CHECKED BY  
 Reviewed & Approved by

GAMBAR NO. DRAWING NO.  
 POSITION NO. TIME COPYRIGHT © ARCHITECTURE 2019



KETERANGAN	DESCRIPTION
	Saluran air bersih
	Sumur air bersih
	Pompa Air
	Septic Tank
	Sumur Resapan

**NOTES**  
 THESE DRAWINGS ARE AN INSTRUMENT OF SERVICE AND ARE THE PROPERTY OF THE CREATOR. ANY USE OF THE DRAWINGS WITHOUT THE PRIOR EXPRESS WRITTEN PERMISSION OF THE CREATOR IS A VIOLATION OF COPYRIGHT AND WILL BE LIABLE TO PROSECUTION. DO NOT SCALE FROM DRAWINGS. USE ONLY GIVEN DIMENSIONS. ALL DIMENSIONS ARE IN MILLIMETRES UNLESS OTHERWISE NOTED.

**PERSETUJUAN APPROVAL**  
**DYAH HENDRAWATI, ST., MSc.**

REV	DATE	REVISION STATUS	SIGN

**PERANCANGAN PUSAT TERAPI & KESEHATAN KHUSUS ANAK AUTIS**

**INSTITUSI**  
 JURUSAN SARJANA ARSITEKTUR  
 FAKULTAS TEKNIK DAN PERENCANAAN  
 UNIVERSITAS ISLAM INDONESIA



**NAMA**  
 MUHAMMAD EDY PRATAMA SURYA

**NOMOR INDIK**  
 MAHASISWA  
 155121095

**DOSEN PEMBIMBING**  
 DYAH HENDRAWATI, ST., MSc.

**DOSEN PENGUJ**  
 HANDOYOTOMO Ir., MSA.

**JUDUL GAMBAR**  
 SKEMA AIR BERSIH

**GAMBAR OLEH**  
 MUHAMMAD EDY PRATAMA SURYA

**SKALA**  
 1 : 400

**BENKAS NO.**  
 FILE NO.

**DRAWN BY**  
 MUHAMMAD EDY PRATAMA SURYA

**CHECKED BY**

**Reviewed & Approved by**

**GAMBAR NO.**  
 DRAWING NO.

**POSITION NO.**  
 THE

**COPYRIGHT**  
 UH ARCHITECTURE 2019

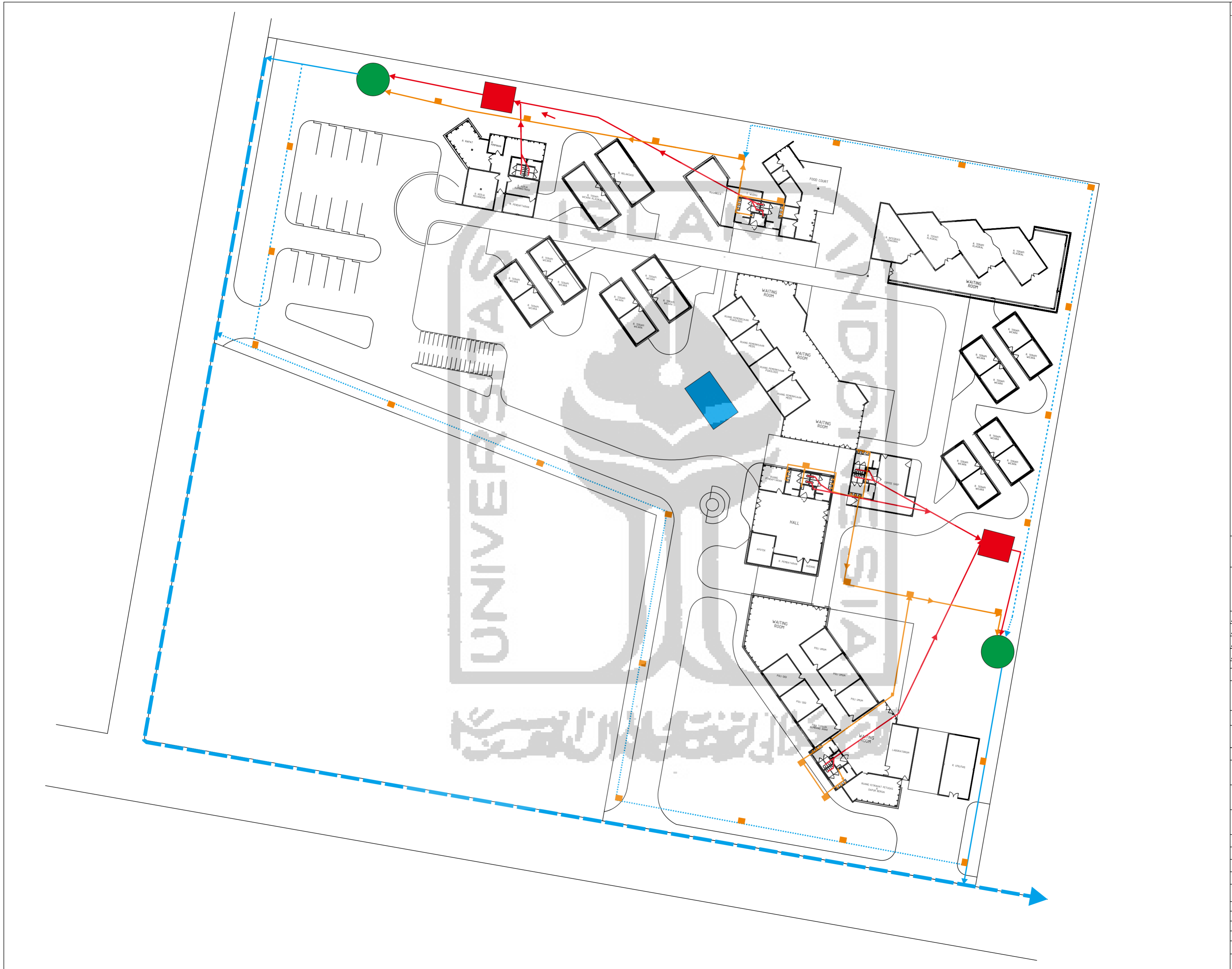





KETERANGAN	DESCRIPTION
	Saluran kotoran padat
	Saluran air kotor
	Saluran air hujan
	Saluran air bersih
	Saluran riol kota
	Sumur air bersih
	Septic Tank
	Bak Kontrol
	Sumur Resapan

<b>NOTES</b>		<b>CATATAN</b>	
<small>THESE DRAWINGS ARE AN INSTRUMENT OF SERVICE AND ARE THE PROPERTY OF THE CREATOR. ANY USE OF THE DRAWINGS WITHOUT THE PRIOR EXPRESS WRITTEN PERMISSION OF THE CREATOR IS A VIOLATION OF COPYRIGHT AND WILL BE LIABLE TO PROSECUTION. DO NOT SCALE FROM DRAWINGS. USE ONLY GIVEN DIMENSIONS. ALL DIMENSIONS ARE IN MILLIMETERS UNLESS OTHERWISE NOTED.</small>			
PERSETUJUAN APPROVAL			
<b>DYAH HENDRAWATI, ST., MSc.</b>			
△			
△			
△			
△			
REV	DATE	REVISION STATUS	SIGN
PROJEK PROJECT			
<b>PERANCANGAN PUSAT TERAPI &amp; KESEHATAN KHUSUS ANAK AUTIS</b>			
INSTITUSI INSTITUTION			
JURUSAN SARJANA ARSITEKTUR FAKULTAS TEKNIK DAN PERENCANAAN UNIVERSITAS ISLAM INDONESIA			
NAMA NAME		NOMOR INDUK MAHASISWA	
<b>MUHAMMAD EDY PRATAMA SURYA</b>		<b>155121095</b>	
DOSEN PEMBIMBING		<b>DYAH HENDRAWATI, ST., MSc.</b>	
DOSEN PENGUJ		<b>HANDYOYOTOMO Ir., MSA.</b>	
JUDUL GAMBAR		DRAWING TITLE	
<b>SKEMA AIR KOTOR DAN KOTORAN PADAT</b>			
GAMBAR OLEH DRAWING BY		<b>MUHAMMAD EDY PRATAMA SURYA</b>	
STATUS STATUS			
SKALA SCALE	<b>1 : 400</b>	BENKAS NO. FILE NO.	
		NAME	SIGN DATE
DRAWN BY			
CHECKED BY			
Reviewed & Approved by			
GAMBAR NO.		DRAWING NO.	
POSITION NO.	TYPE	COPYRIGHT © ARCHITECTURE 2019	



KETERANGAN	DESCRIPTION
	= Genset
	= Panel
	= Trafo
	= Jaringan Tray Utama
	= Jaringan Tray Cabang

**NOTES**  
 THESE DRAWINGS ARE AN INSTRUMENT OF SERVICE AND ARE THE PROPERTY OF THE CREATOR. ANY USE OF THE DRAWINGS WITHOUT THE PRIOR EXPRESS WRITTEN PERMISSION OF THE CREATOR IS A VIOLATION OF COPYRIGHT AND WILL BE LIABLE TO PROSECUTION. DO NOT SCALE FROM DRAWINGS. USE ONLY GIVEN DIMENSIONS. ALL DIMENSIONS ARE IN MILLIMETRES UNLESS OTHERWISE NOTED.

**PERSETUJUAN APPROVAL**  
**DYAH HENDRAWATI, ST., MSc.**

REV	DATE	REVISION STATUS	SIGN

**PERANCANGAN PUSAT TERAPI & KESEHATAN KHUSUS ANAK AUTIS**

**JURUSAN SARJANA ARSITEKTUR  
 FAKULTAS TEKNIK DAN PERENCANAAN  
 UNIVERSITAS ISLAM INDONESIA**

**MUHAMMAD EDY PRATAMA SURYA**  
 155121095

**DYAH HENDRAWATI, ST., MSc.**

**HANDYOYOTOMO Ir., MSA.**

**SKEMA PENYEDIAAN ENERGI**

**MUHAMMAD EDY PRATAMA SURYA**

SKALA SCALE	1 : 400	BENKAS NO. FILE NO.	NAME	SIGN	DATE
DRAWN BY					
CHECKED BY					
Reviewed & Approved by					
GAMBAR NO.	DRAWING NO.				



KETERANGAN	DESCRIPTION
<span style="display:inline-block; width:15px; height:10px; background-color:orange;"></span>	= AC DAIKIN Indoor Unit 1 pk
<span style="display:inline-block; width:15px; height:10px; background-color:blue;"></span>	= AC DAIKIN Outdoor Unit

**NOTES**  
 THESE DRAWINGS ARE AN INSTRUMENT OF SERVICE AND ARE THE PROPERTY OF THE CREATOR. ANY USE OF THE DRAWINGS WITHOUT THE PRIOR EXPRESS WRITTEN PERMISSION OF THE CREATOR IS A VIOLATION OF COPYRIGHT AND WILL BE LIABLE TO PROSECUTION. DO NOT SCALE FROM DRAWINGS. USE ONLY GIVEN DIMENSIONS. ALL DIMENSIONS ARE IN MILLIMETERS UNLESS OTHERWISE NOTED.

**CATATAN**  
 CATATAN

PERSETUJUAN APPROVAL

**DYAH HENDRAWATI, ST., MSc.**

△			
△			
△			
△			

REV	DATE	REVISION STATUS	SIGN

PROJEK PROJECT

**PERANCANGAN PUSAT TERAPI & KESEHATAN KHUSUS ANAK AUTIS**

INSTITUSI INSTITUTION	
JURUSAN SARJANA ARSITEKTUR FAKULTAS TEKNIK DAN PERENCANAAN UNIVERSITAS ISLAM INDONESIA	
NAMA NAME	NOMOR INDUK MAHASISWA 155121095
<b>MUHAMMAD EDY PRATAMA SURYA</b>	

DOSEN PEMBIMBING **DYAH HENDRAWATI, ST., MSc.**

DOSEN PENGUJ **HANDOYOTOMO Ir., MSA.**

JUDUL GAMBAR DRAWING TITLE **SKEMA PENGHAWAAN**

GAMBAR OLEH DRAWING BY **MUHAMMAD EDY PRATAMA SURYA**

STATUS STATUS

SKALA SCALE <b>1 : 400</b>	BENKAS NO. FILE NO.	NAME	SIGN	DATE
----------------------------	---------------------	------	------	------

DRAWN BY

CHECKED BY

Reviewed & Approved by

GAMBAR NO.	DRAWING NO.
------------	-------------

POSITION NO. TYPE COPYRIGHT OR ARCHITECTURE 2019

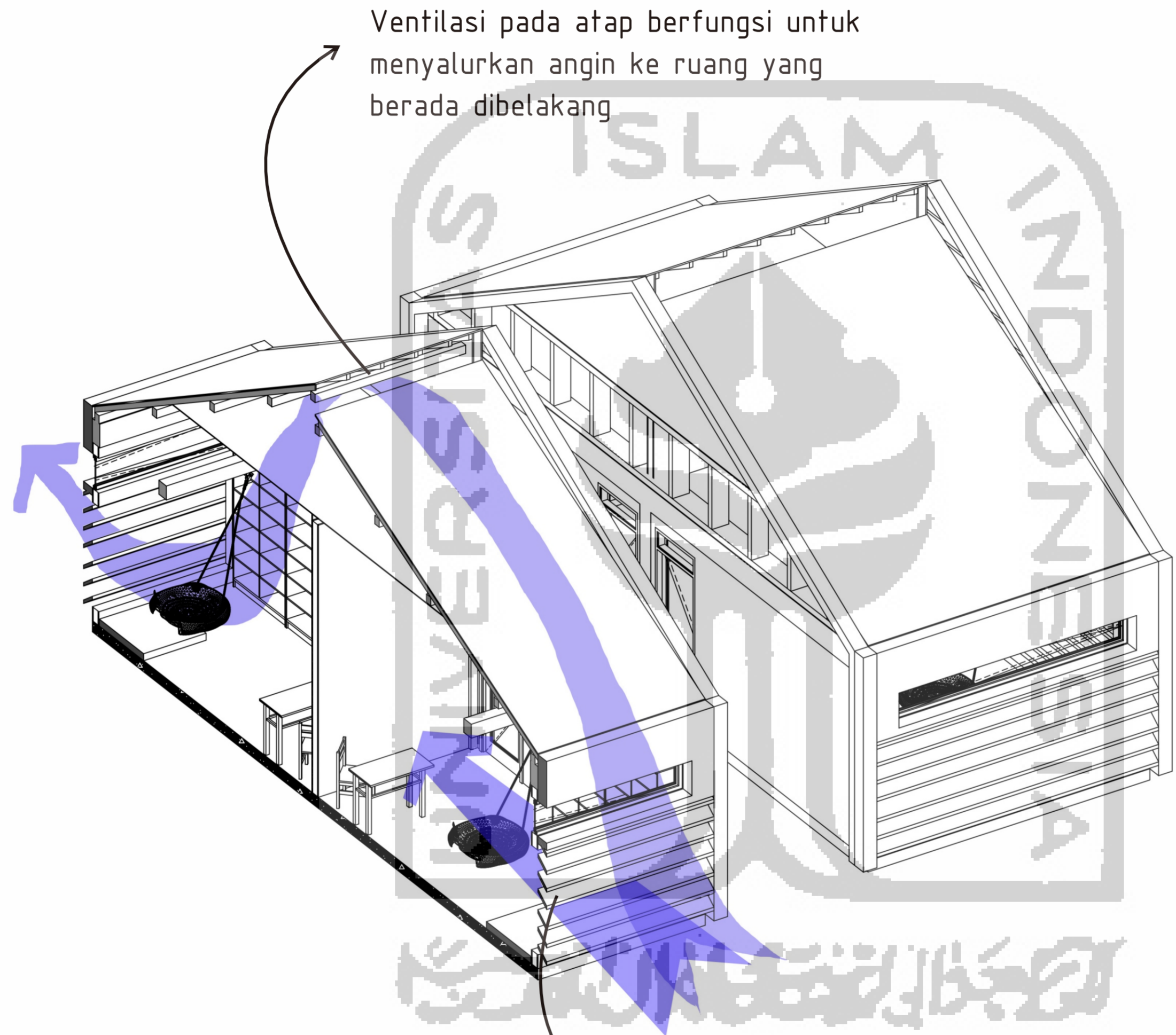

Ventilasi pada atap berfungsi untuk menyalurkan angin ke ruang yang berada dibelakang

Jalusi pada bukaan berfungsi untuk mengurangi kecepatan angin yang datang

SKEMA PENGHAWAAN ALAMI

KETERANGAN DESCRIPTION

NOTES CATATAN  
 THESE DRAWINGS ARE AN INSTRUMENT OF SERVICE AND ARE THE PROPERTY OF THE CREATOR ANY USE OF THE DRAWINGS WITHOUT THE PRIOR EXPRESS WRITTEN PERMISSION OF THE CREATOR IS A VIOLATION OF COPYRIGHT AND WILL BE LIABLE TO PROSECUTION. DO NOT SCALE FROM DRAWINGS. USE ONLY GIVEN DIMENSIONS. ALL DIMENSIONS ARE IN MILLIMETRES UNLESS OTHERWISE NOTED.

PERSETUJUAN APPROVAL  
**DYAH HENDRAWATI, ST., MSc.**

REV	DATE	REVISION STATUS	SIGN
△			
△			
△			

PROYEK PROJECT

**PERANCANGAN PUSAT TERAPI & KESEHATAN KHUSUS ANAK AUTIS**

INSTITUSI INSTITUTION  
 JURUSAN SARJANA ARSITEKTUR FAKULTAS TEKNIK DAN PERENCANAAN UNIVERSITAS ISLAM INDONESIA

NAMA NAME  
**MUHAMMAD EDY PRATAMA SURYA**      NOMOR INDIK MAHASISWA 155121095

DOSEN PEMBIMBING  
**DYAH HENDRAWATI, ST., MSc.**

DOSEN PENGUJI  
**HANDOYOTOMO Ir., MSA.**

JUDUL GAMBAR DRAWING TITLE

GAMBAR OLEH DRAWING BY  
**MUHAMMAD EDY PRATAMA SURYA**

STATUS STATUS  
**SKEMA PENGHAWAAN ALAMI**

SKALA SCALE 1:50      BERSAS NO. FILE NO.

DRAWN BY  
 CHECKED BY

Reviewed & Approved by

GAMBAR NO. DRAWING NO.

POSITION NO. TYPE COPYRIGHT OR ARCHITECTURE 2019

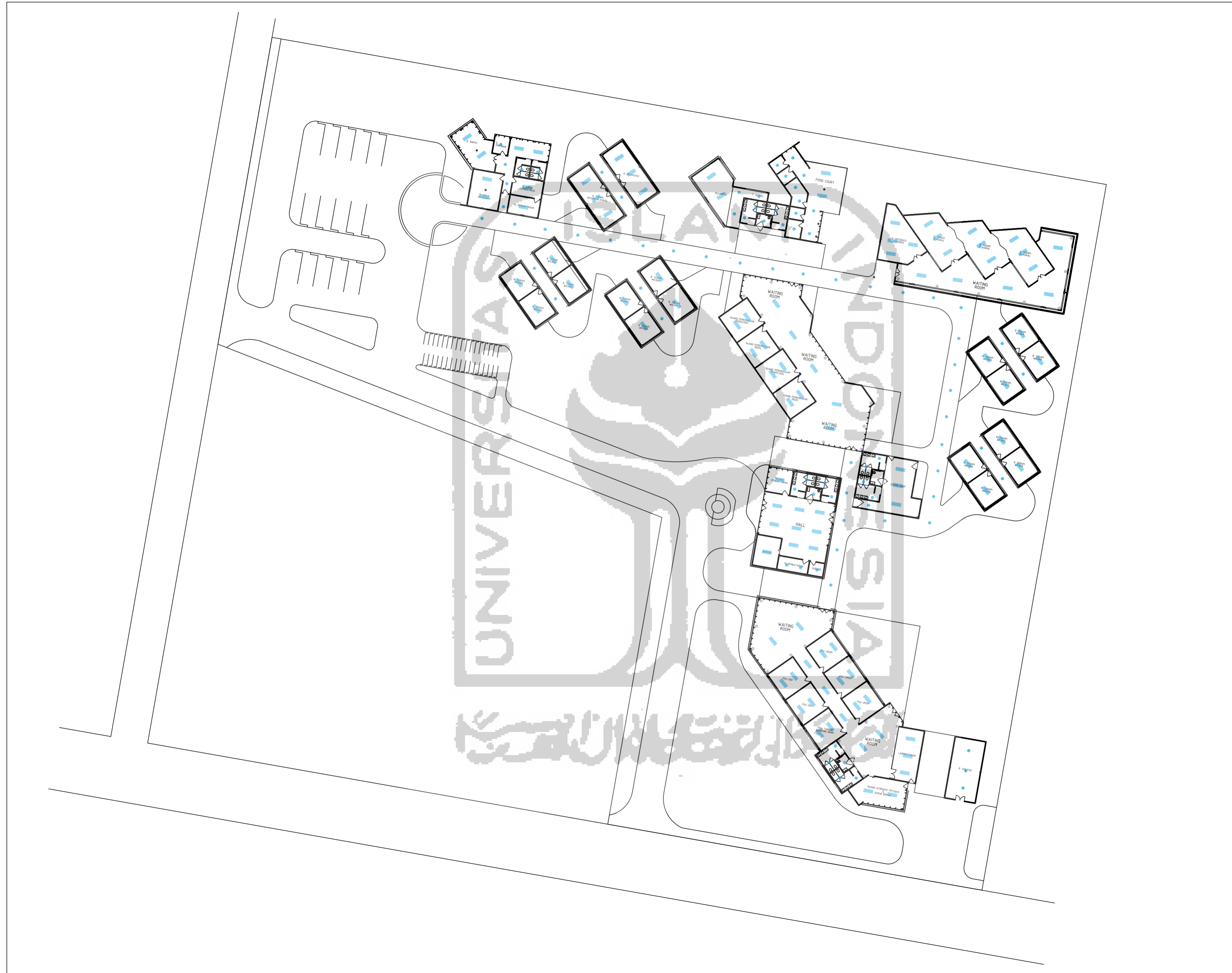

KETERANGAN	DESCRIPTION
<span style="color: blue;">▭</span>	Lampu Flourescent Philips
<span style="color: blue;">●</span>	Lampu Ceiling LED
<span style="color: purple;">●</span>	Lampu Downlight

<b>NOTES</b>		<b>CATATAN</b>	
<small>THESE DRAWINGS ARE AN INSTRUMENT OF SERVICE AND ARE THE PROPERTY OF THE CREATOR. ANY USE OF THE DRAWINGS WITHOUT THE PRIOR EXPRESS WRITTEN PERMISSION OF THE CREATOR IS A VIOLATION OF COPYRIGHT AND WILL BE LIABLE TO PROSECUTION. DO NOT SCALE FROM DRAWINGS. USE ONLY GIVEN DIMENSIONS. ALL DIMENSIONS ARE IN MILLIMETERS UNLESS OTHERWISE NOTED.</small>			
PERSETUJUAN APPROVAL			
<b>DYAH HENDRAWATI, ST., MSc.</b>			
△			
△			
△			
△			
REV	DATE	REVISION STATUS	SIGN
PROJEK PROJECT			
<b>PERANCANGAN PUSAT TERAPI &amp; KESEHATAN KHUSUS ANAK AUTIS</b>			
INSTITUSI INSTITUTION			
<small>JURUSAN SARJANA ARSITEKTUR FAKULTAS TEKNIK DAN PERENCANAAN UNIVERSITAS ISLAM INDONESIA</small>			
NAMA NAME		NOMOR INDUK MAHASISWA	
<b>MUHAMMAD EDY PRATAMA SURYA</b>		<b>155121095</b>	
DOSEN PEMBIMBING			
<b>DYAH HENDRAWATI, ST., MSc.</b>			
DOSEN PENGUII			
<b>HANDYOYOTOMO Ir., MSA.</b>			
JUDUL GAMBAR		DRAWING TITLE	
<b>SKEMA PENCAHAYAAN</b>			
GAMBAR OLEH DRAWING BY		<b>MUHAMMAD EDY PRATAMA SURYA</b>	
STATUS STATUS			
SKALA SCALE	<b>1 : 400</b>	BENKAS NO. FILE NO.	
		NAME	SIGN DATE
DRAWN BY			
CHECKED BY			
Reviewed & Approved by			
GAMBAR NO.		DRAWING NO.	
POSITION NO.	TYPE	COPYRIGHT © ARCHITECTURE 2019	



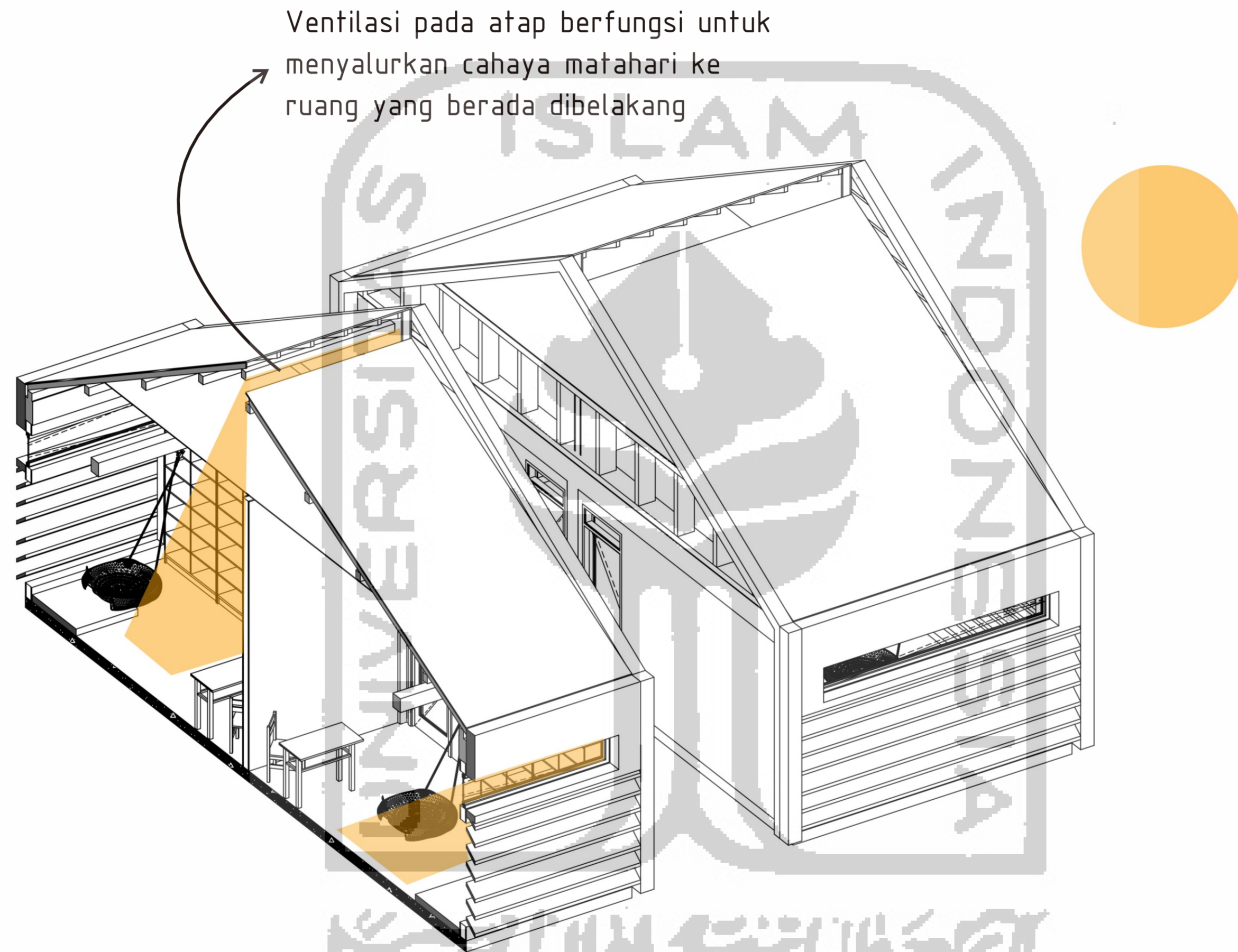

Ventilasi pada atap berfungsi untuk menyalurkan cahaya matahari ke ruang yang berada dibelakang

SKEMA PENCAHAYAAN ALAMI

KETERANGAN DESCRIPTION

NOTES CATATAN  
 THESE DRAWINGS ARE AN INSTRUMENT OF SERVICE AND ARE THE PROPERTY OF THE CREATOR. ANY USE OF THE DRAWINGS WITHOUT THE PRIOR EXPRESS WRITTEN PERMISSION OF THE CREATOR IS A VIOLATION OF COPYRIGHT AND WILL BE LIABLE TO PROSECUTION. DO NOT SCALE FROM DRAWINGS. USE ONLY GIVEN DIMENSIONS. ALL DIMENSIONS ARE IN MILLIMETRES UNLESS OTHERWISE NOTED.

PERSETUJUAN APPROVAL  
**DYAH HENDRAWATI, ST., MSc.**

REV	DATE	REVISION STATUS	SIGN
△			
△			
△			

PROYEK PROJECT

**PERANCANGAN PUSAT TERAPI & KESEHATAN KHUSUS ANAK AUTIS**

INSTITUSI INSTITUTION  
 JURUSAN SARJANA ARSITEKTUR FAKULTAS TEKNIK DAN PERENCANAAN UNIVERSITAS ISLAM INDONESIA

NAMA NAME  
**MUHAMMAD EDY PRATAMA SURYA**  
 NO. INDUK MAHASISWA 155121095

DOSEN PEMBIMBING  
**DYAH HENDRAWATI, ST., MSc.**

DOSEN PENGUJI  
**HANDOYOTOMO Ir., MSA.**

JUDUL GAMBAR DRAWING TITLE

GAMBAR OLEH DRAWING BY  
**MUHAMMAD EDY PRATAMA SURYA**

STATUS STATUS  
**SKEMA PENCAHAYAAN ALAMI**

SKALA SCALE  
**1:50**  
 NO. FILE NO. NAME SIGN DATE

DRAWN BY  
 CHECKED BY  
 Reviewed & Approved by

GAMBAR NO. DRAWING NO.

POSITION NO. TYPE COPYRIGHT OR ARCHITECTURE 2019



**KETERANGAN**      **DESCRIPTION**

= Ramp

**NOTES**  
 THESE DRAWINGS ARE AN INSTRUMENT OF SERVICE AND ARE THE PROPERTY OF THE CREATOR. ANY USE OF THE DRAWINGS WITHOUT THE PRIOR EXPRESS WRITTEN PERMISSION OF THE CREATOR IS A VIOLATION OF COPYRIGHT AND WILL BE LIABLE TO PROSECUTION. DO NOT SCALE FROM DRAWINGS. USE ONLY GIVEN DIMENSIONS. ALL DIMENSIONS ARE IN MILLIMETRES UNLESS OTHERWISE NOTED.

**PERSETUJUAN APPROVAL**  
**DYAH HENDRAWATI, ST., MSc.**

△			
△			
△			
△			
REV	DATE	REVISION STATUS	SIGN

PROJEK PROJECT

**PERANCANGAN PUSAT TERAPI & KESEHATAN KHUSUS ANAK AUTIS**

INSTITUSI INSTITUTION  
 JURUSAN SARJANA ARSITEKTUR  
 FAKULTAS TEKNIK DAN PERENCANAAN  
 UNIVERSITAS ISLAM INDONESIA



NAMA NAME: **MUHAMMAD EDY PRATAMA SURYA**  
 NOMOR INDIK MAHASISWA: **155121095**

DOSEN PEMBIMBING: **DYAH HENDRAWATI, ST., MSc.**

DOSEN PENGUJ: **HANDOYOTOMO Ir., MSA.**

JUDUL GAMBAR DRAWING TITLE: **SKEMA TRANSPORTASI BANGUNAN**

GAMBAR OLEH DRAWING BY: **MUHAMMAD EDY PRATAMA SURYA**

STATUS STATUS: **BERKAS NO. FILE NO.**

SKALA SCALE: **1:400**

DRAWN BY: \_\_\_\_\_  
 CHECKED BY: \_\_\_\_\_  
 Reviewed & Approved by: \_\_\_\_\_

GAMBAR NO. \_\_\_\_\_ DRAWING NO. \_\_\_\_\_  
 POSITION NO. \_\_\_\_\_ TYPE \_\_\_\_\_ COPYRIGHT UIN ARCHITECTURE 2019

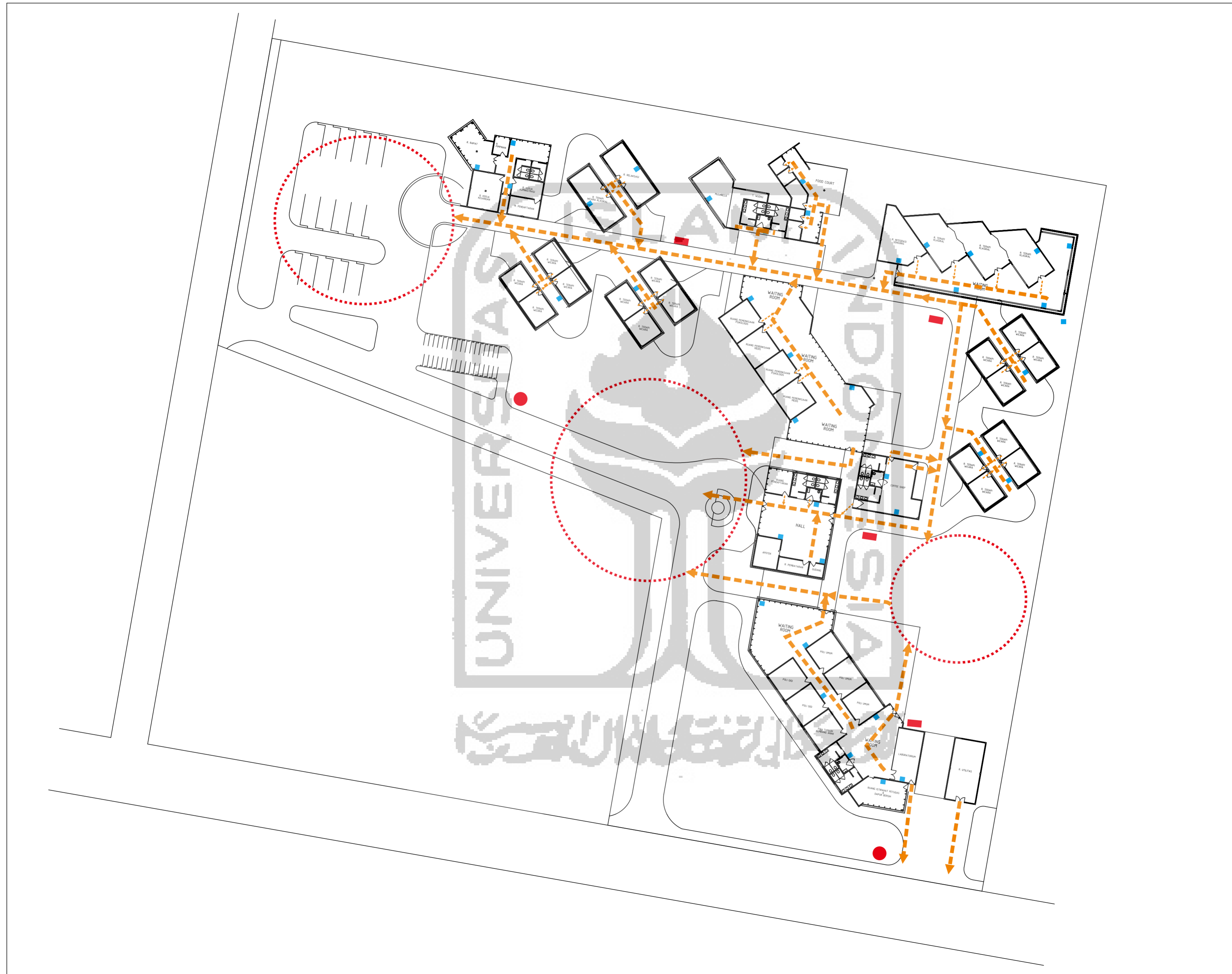

KETERANGAN	DESCRIPTION
<span style="color: red;">■</span>	= Hydrant Box
<span style="color: red;">●</span>	= Hydrant Pillar
<span style="color: blue;">■</span>	= Apar
<span style="color: red;">⊙</span>	= Titik Kumpul
<span style="color: orange;">→</span>	= Jalur Evakuasi

**NOTES**  
 THESE DRAWINGS ARE AN INSTRUMENT OF SERVICE AND ARE THE PROPERTY OF THE CREATOR. ANY USE OF THE DRAWINGS WITHOUT THE PRIOR EXPRESS WRITTEN PERMISSION OF THE CREATOR IS A VIOLATION OF COPYRIGHT AND WILL BE LIABLE TO PROSECUTION. DO NOT SCALE FROM DRAWINGS. USE ONLY GIVEN DIMENSIONS. ALL DIMENSIONS ARE IN MILLIMETRES UNLESS OTHERWISE NOTED.

**PERSETUJUAN APPROVAL**  
**DYAH HENDRAWATI, ST., MSc.**

REV	DATE	REVISION STATUS	SIGN

**PERANCANGAN PUSAT TERAPI & KESEHATAN KHUSUS ANAK AUTIS**

**JURUSAN SARJANA ARSITEKTUR  
 FAKULTAS TEKNIK DAN PERENCANAAN  
 UNIVERSITAS ISLAM INDONESIA**

**MUHAMMAD EDY PRATAMA SURYA**  
 155121095

**DYAH HENDRAWATI, ST., MSc.**

**HANDOYOTOMO Ir., MSA.**

**SKEMA KEBAKARAN & EVAKUASI**

**MUHAMMAD EDY PRATAMA SURYA**

**SKALA SCALE 1 : 400**

**DRAWN BY**  
**CHECKED BY**  
**Reviewed & Approved by**

**GAMBAR NO.**      **DRAWING NO.**



KETERANGAN	DESCRIPTION
<span style="display:inline-block; width:15px; height:15px; background-color:yellow; border:1px solid black;"></span>	= Ramp Difabel
<span style="display:inline-block; width:15px; height:15px; background-color:lightcoral; border:1px solid black;"></span>	= Toilet Difabel
<span style="display:inline-block; width:15px; height:15px; background-color:orange; border:1px solid black;"></span>	= Guiding Block

**NOTES**  
 THESE DRAWINGS ARE AN INSTRUMENT OF SERVICE AND ARE THE PROPERTY OF THE CREATOR. ANY USE OF THE DRAWINGS WITHOUT THE PRIOR EXPRESS WRITTEN PERMISSION OF THE CREATOR IS A VIOLATION OF COPYRIGHT AND WILL BE LIABLE TO PROSECUTION. DO NOT SCALE FROM DRAWINGS. USE ONLY GIVEN DIMENSIONS. ALL DIMENSIONS ARE IN MILLIMETRES UNLESS OTHERWISE NOTED.

**PERSETUJUAN APPROVAL**  
**DYAH HENDRAWATI, ST., MSc.**

REV	DATE	REVISION STATUS	SIGN

PROJEK PROJECT

**PERANCANGAN PUSAT TERAPI & KESEHATAN KHUSUS ANAK AUTIS**

INSTITUSI INSTITUTION  
 JURUSAN SARJANA ARSITEKTUR FAKULTAS TEKNIK DAN PERENCANAAN UNIVERSITAS ISLAM INDONESIA



NAMA NAME: **MUHAMMAD EDY PRATAMA SURYA**  
 NOMOR INDIK MAHASISWA: **155121095**

DOSEN PEMBIMBING: **DYAH HENDRAWATI, ST., MSc.**

DOSEN PENGUJ: **HANDOYOTOMO Ir., MSA.**

JUDUL GAMBAR DRAWING TITLE: **SKEMA BARRIER FREE DESIGN**

GAMBAR OLEH DRAWING BY: **MUHAMMAD EDY PRATAMA SURYA**

STATUS STATUS

SKALA SCALE: **1:400**      BENSAS NO. FILE NO.

DRAWN BY:      NAME      SIGN      DATE

CHECKED BY:

Reviewed & Approved by:

GAMBAR NO.      DRAWING NO.

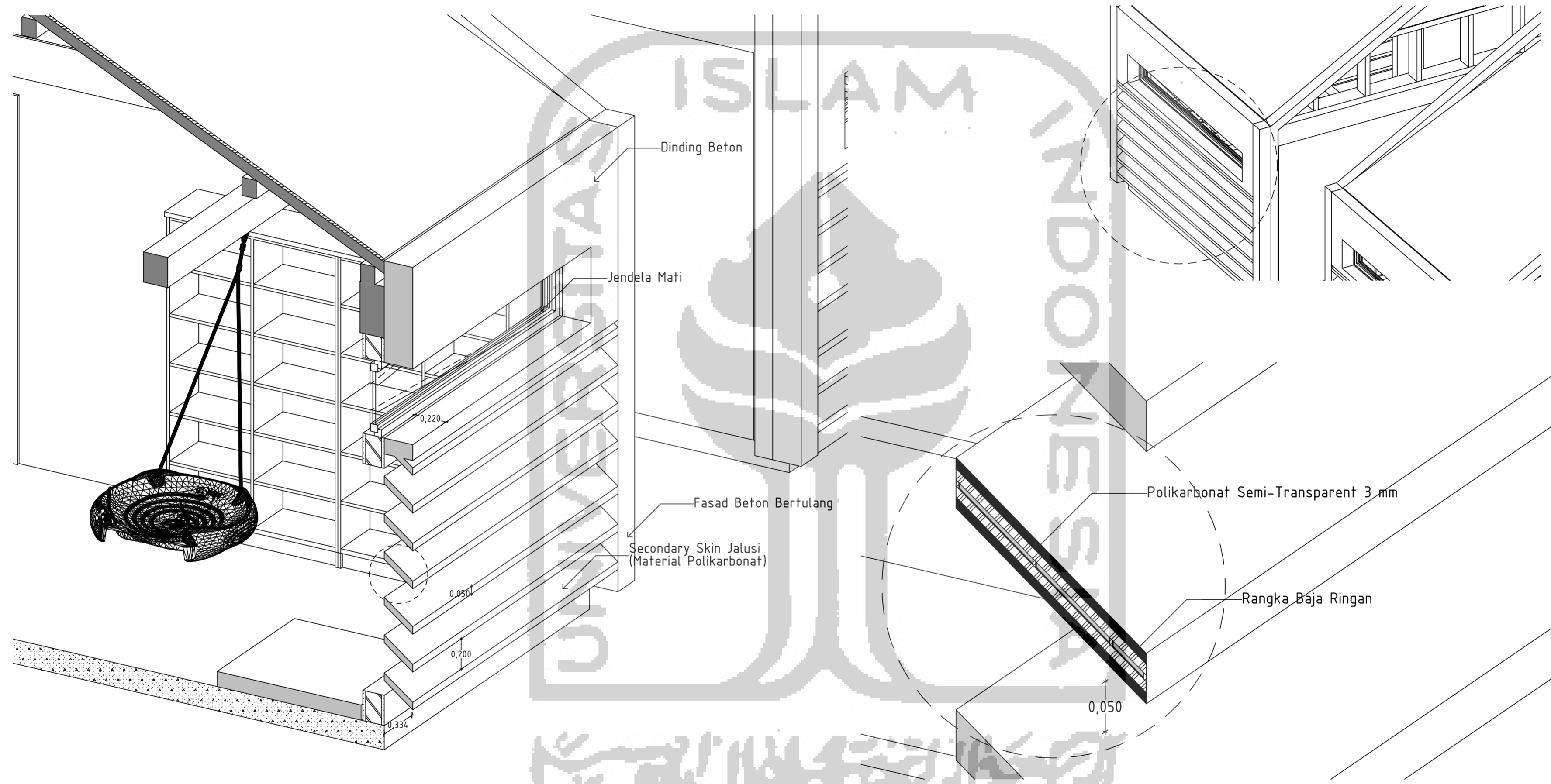

○ DETAIL SELUBUNG BANGUNAN

TERANGAN DESCRIPTION

**NOTES**  
 THESE DRAWINGS ARE AN INSTRUMENT OF SERVICE AND ARE THE PROPERTY OF THE CREATOR. ANY USE OF THE DRAWINGS WITHOUT THE PRIOR EXPRESS WRITTEN PERMISSION OF THE CREATOR IS A VIOLATION OF COPYRIGHT AND WILL BE LIABLE TO PROSECUTION. DO NOT SCALE FROM DRAWINGS. USE ONLY GIVEN DIMENSIONS. ALL DIMENSIONS ARE IN MILLIMETRES UNLESS OTHERWISE NOTED.

PERSETUJUAN APPROVAL  
**DYAH HENDRAWATI, ST., MSc.**

REV	DATE	REVISION STATUS	SIGN
△			
△			
△			

PERANCANGAN PUSAT TERAPI & KESEHATAN KHUSUS ANAK AUTIS

INSTITUSI  
 JURUSAN SARJANA ARSITEKTUR  
 FAKULTAS TEKNIK DAN PERENCANAAN  
 UNIVERSITAS ISLAM INDONESIA

NAMA  
**MUHAMMAD EDY PRATAMA SURYA**

DOSEN PEMBIMBING  
**DYAH HENDRAWATI, ST., MSc.**

DOSEN PENGUJI  
**HANDYOTOMO Ir., MSA.**

JUDUL GAMBAR  
**DETAIL SELUBUNG BANGUNAN**

GAMBAR OLEH  
**MUHAMMAD EDY PRATAMA SURYA**

SKALA  
**1:50, 1:20, 1:3**

GAMBAR NO.  
 DRAWING NO.

POSITION NO. TYPE COPYRIGHT OR ARCHITECTURE 2019

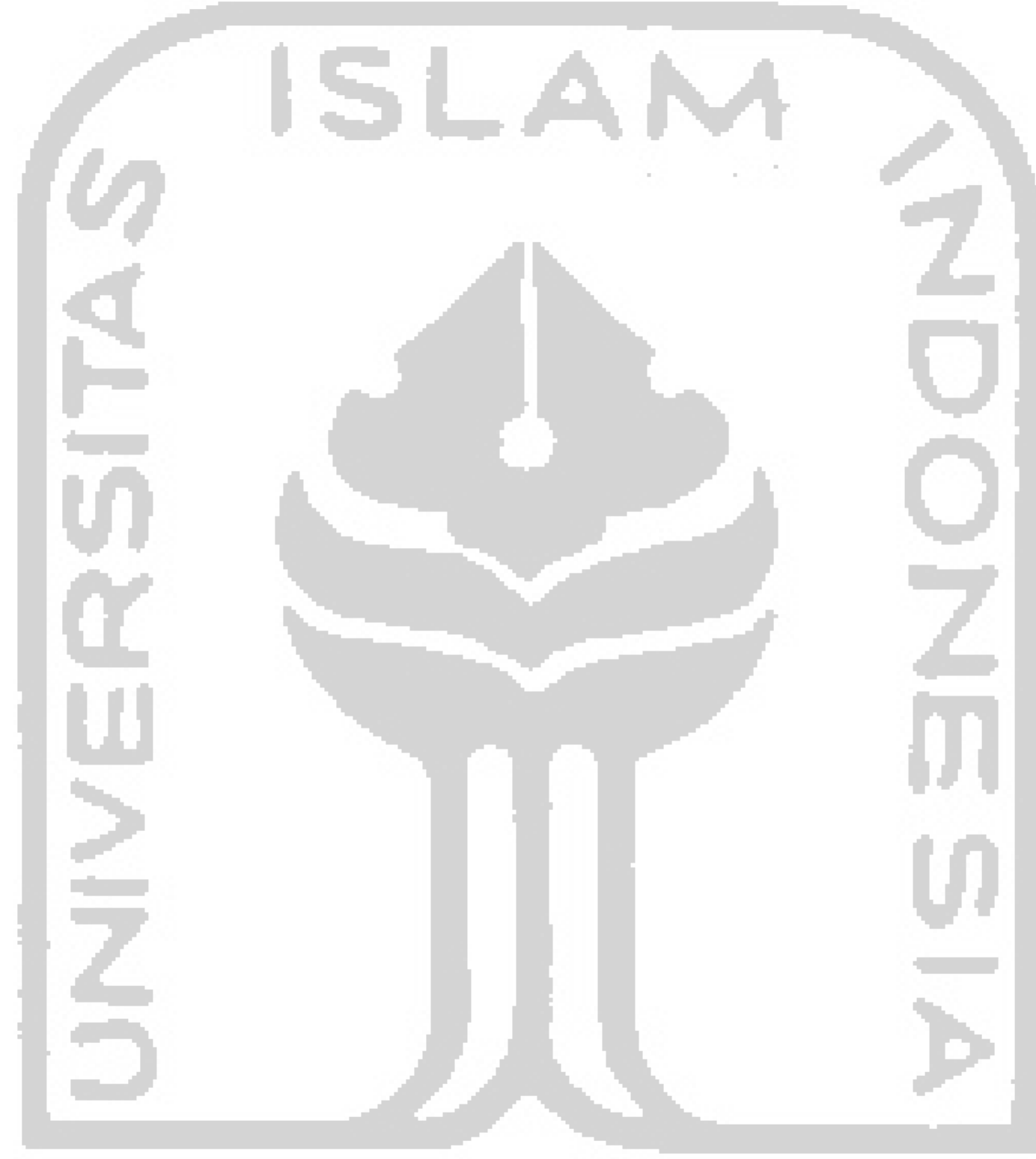

جامعة الإسلام في إندونيسيا



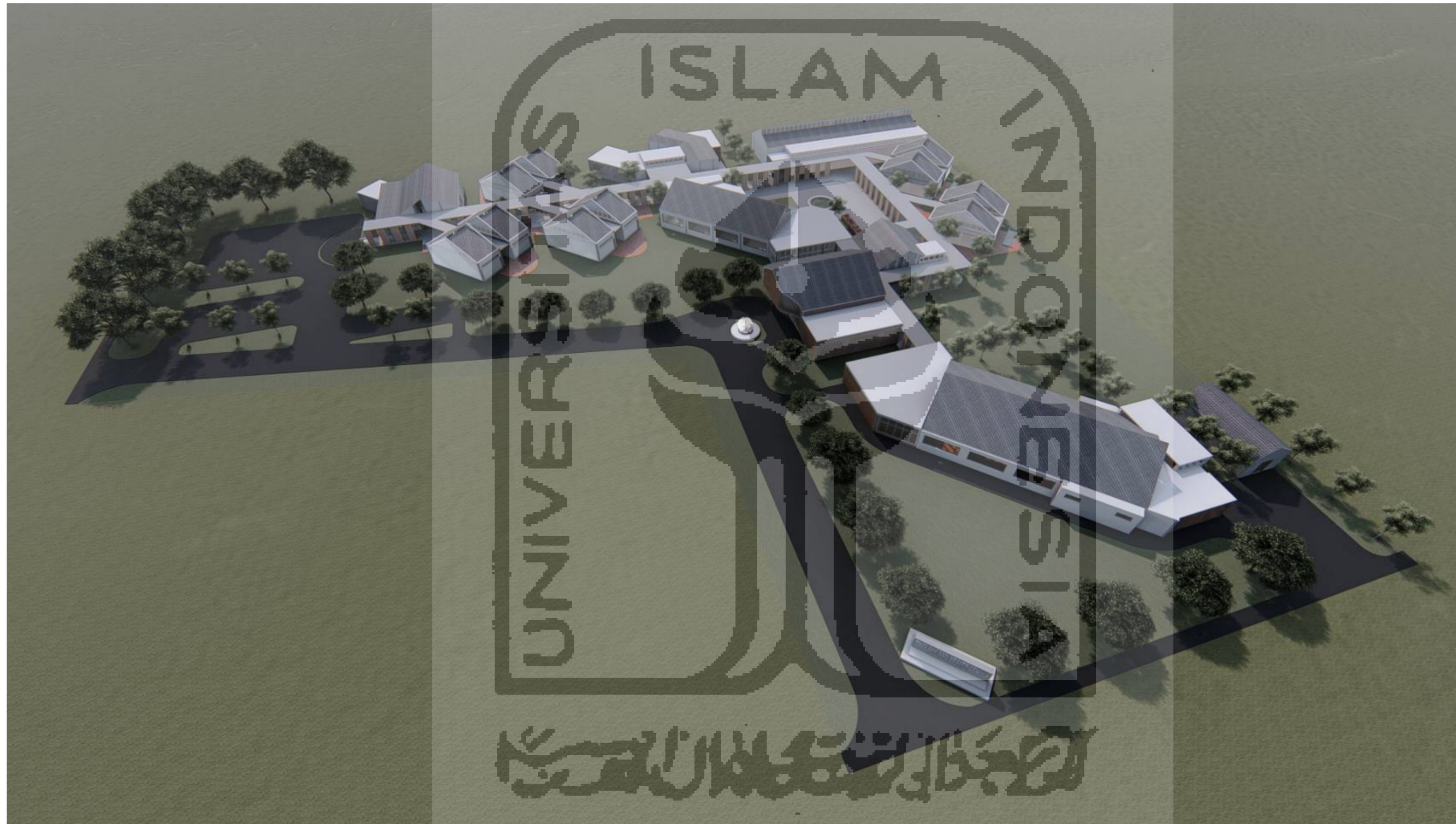

○ PERSPEKTIF EKSTERIOR

**CATATAN**  
 THESE DRAWINGS ARE AN INSTRUMENT OF SERVICE AND ARE THE PROPERTY OF THE CREATOR. ANY USE OF THE DRAWINGS WITHOUT THE PRIOR EXPRESS WRITTEN PERMISSION OF THE CREATOR IS A VIOLATION OF COPYRIGHT AND WILL BE LIABLE TO PROSECUTION. DO NOT SCALE FROM DRAWINGS. USE ONLY GIVEN DIMENSIONS. ALL DIMENSIONS ARE IN MILLIMETERS UNLESS OTHERWISE NOTED.

**PERSetujuan**  
 APPROVAL  
**DYAH HENDRAWATI, ST., MSc.**

△			
△			
△			
△			
REV	DATE	REVISION STATUS	SIGN

PROJEK  
 PROJECT

**PERANCANGAN PUSAT TERAPI & KESEHATAN KHUSUS ANAK AUTIS**

INSTITUSI  
 INSTITUTION  
**JURUSAN SARJANA ARSITEKTUR  
 FAKULTAS TEKNIK DAN PERENCANAAN  
 UNIVERSITAS ISLAM INDONESIA**

NAMA  
 NAME  
**MUHAMMAD EDY PRATAMA SURYA**

DOSEN PEMBIMBING  
**DYAH HENDRAWATI, ST., MSc.**

DOSEN PENGUJ  
**HANDOYOTOMO Ir., MSA.**

JUDUL GAMBAR  
 DRAWING TITLE

GAMBAR OLEH  
 DRAWING BY  
**MUHAMMAD EDY PRATAMA SURYA**

STATUS  
**PERSPEKTIF EKSTERIOR**

SKALA  
 SCALE  
**1:100**

DRAWN BY  
 CHECKED BY  
 Reviewed & Approved by

GAMBAR NO.  
 DRAWING NO.

POSITION NO. THIS COPYRIGHT © ARCHITECTURE 2019



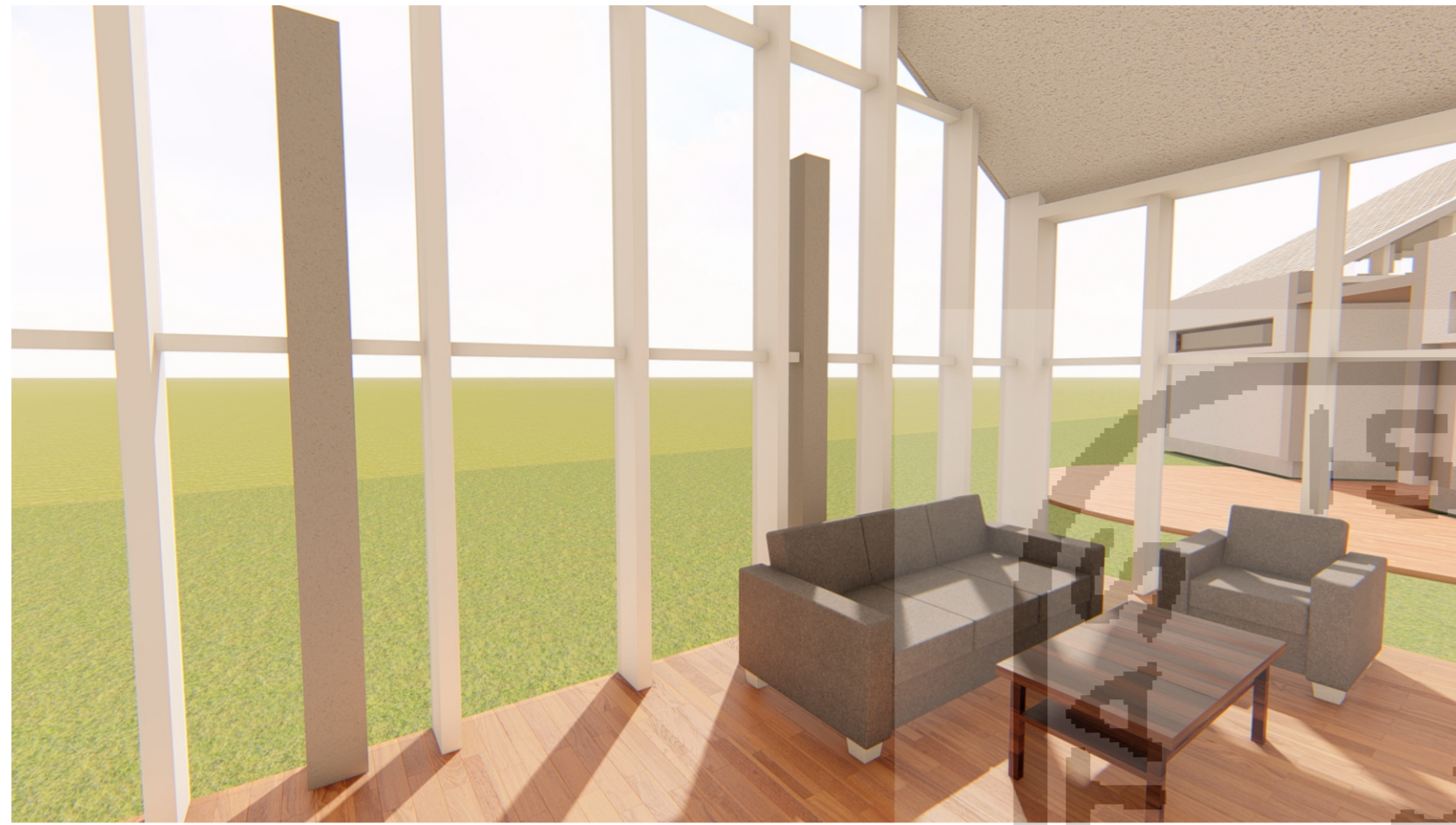

PERSPEKTIF INTERIOR

**NOTES**  
 THESE DRAWINGS ARE AN INSTRUMENT OF SERVICE AND ARE THE PROPERTY OF THE CREATOR. ANY USE OF THE DRAWINGS WITHOUT THE PRIOR EXPRESS WRITTEN PERMISSION OF THE CREATOR IS A VIOLATION OF COPYRIGHT AND WILL BE LIABLE TO PROSECUTION. DO NOT SCALE FROM DRAWINGS. USE ONLY GIVEN DIMENSIONS. ALL DIMENSIONS ARE IN MILLIMETRES UNLESS OTHERWISE NOTED.

**CATATAN**  
 CATATAN

PERSETUJUAN APPROVAL

**DYAH HENDRAWATI, ST., MSc.**

△			
△			
△			
△			
REV	DATE	REVISION STATUS	SIGN

PROYEK PROJECT

**PERANCANGAN PUSAT TERAPI & KESEHATAN KHUSUS ANAK AUTIS**

INSTITUSI INSTITUTION  
 JURUSAN SARJANA ARSITEKTUR FAKULTAS TEKNIK DAN PERENCANAAN UNIVERSITAS ISLAM INDONESIA

NAMA NAME: **MUHAMMAD EDY PRATAMA SURYA**  
 NOMOR INDIK MAHASISWA: **155121095**

DOSEN PEMBIMBING: **DYAH HENDRAWATI, ST., MSc.**

DOSEN PENGUJI: **HANDOYOTOMO Ir., MSA.**

JUDUL GAMBAR DRAWING TITLE

GAMBAR OLEH DRAWING BY: **MUHAMMAD EDY PRATAMA SURYA**

STATUS STATUS: **PERSPEKTIF INTERIOR**

SKALA SCALE: **1:100**  
 BERKAS NO. FILE NO. NAME SIGN DATE

DRAWN BY  
 CHECKED BY  
 Reviewed & Approved by

GAMBAR NO. DRAWING NO.  
 POSITION NO. TITLE COPYRIGHT © ARCHITECTURE 2019

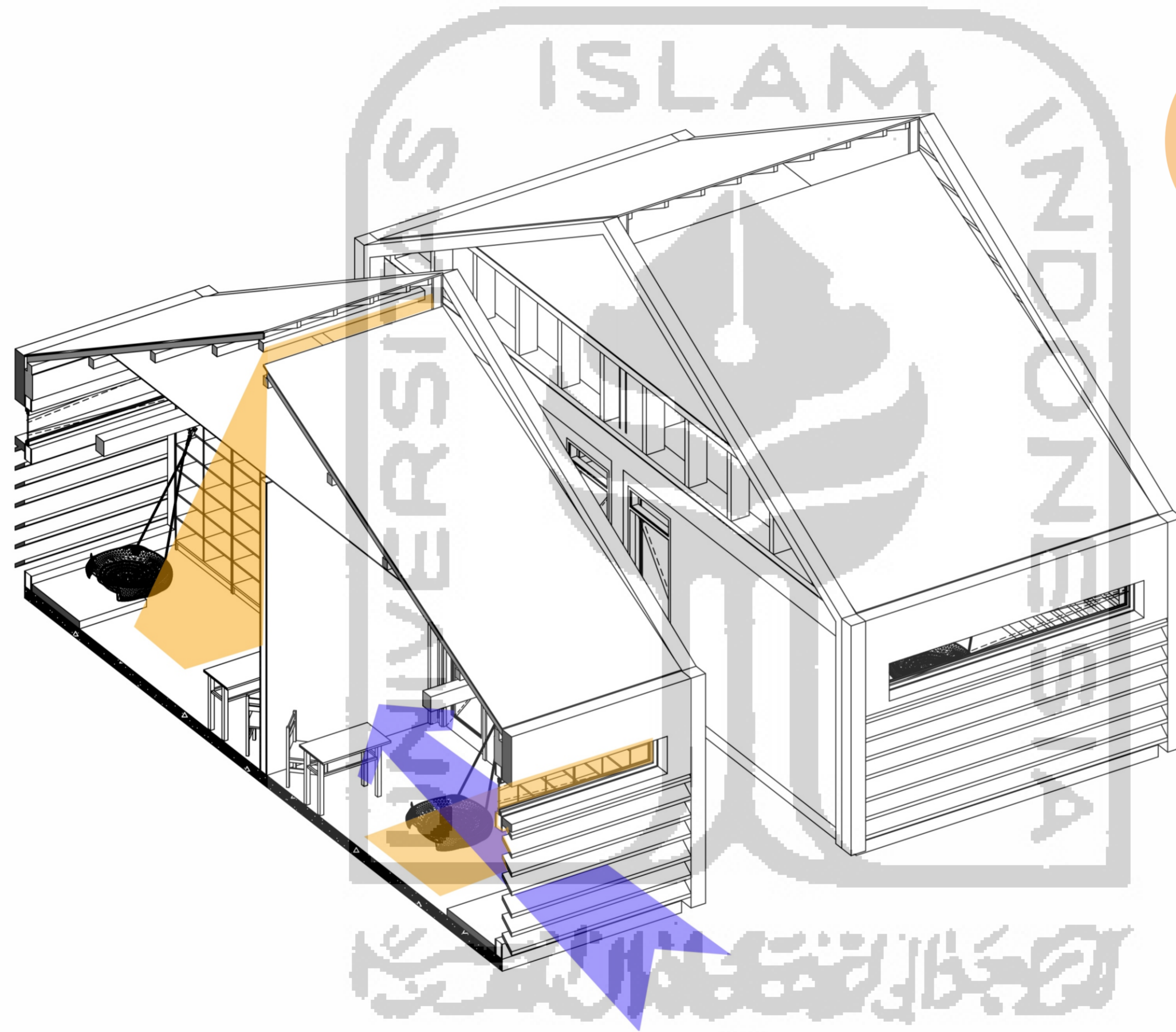

SKEMA PENGHAWAAN ALAMI

KETERANGAN DESCRIPTION

**CATATAN**  
 THESE DRAWINGS ARE AN INSTRUMENT OF SERVICE AND ARE THE PROPERTY OF THE CREATOR. ANY USE OF THE DRAWINGS WITHOUT THE PRIOR EXPRESS WRITTEN PERMISSION OF THE CREATOR IS A VIOLATION OF COPYRIGHT AND WILL BE LIABLE TO PROSECUTION. DO NOT SCALE FROM DRAWINGS. USE ONLY GIVEN DIMENSIONS. ALL DIMENSIONS ARE IN MILLIMETRES UNLESS OTHERWISE NOTED.

PERSETUJUAN APPROVAL  
**DYAH HENDRAWATI, ST., MSc.**

REV	DATE	REVISION STATUS	SIGN
△			
△			
△			

PROYEK PROJECT

**PERANCANGAN PUSAT TERAPI & KESEHATAN KHUSUS ANAK AUTIS**

INSTITUSI INSTITUTION  
 JURUSAN SARJANA ARSITEKTUR FAKULTAS TEKNIK DAN PERENCANAAN UNIVERSITAS ISLAM INDONESIA

NAMA NAME: **MUHAMMAD EDY PRATAMA SURYA**  
 NOMOR INDIK MAHASISWA: **155121095**

DOSEN PEMBIMBING: **DYAH HENDRAWATI, ST., MSc.**

DOSEN PENGUJI: **HANDOYOTOMO Ir., MSA.**

JUDUL GAMBAR DRAWING TITLE

GAMBAR OLEH DRAWING BY: **MUHAMMAD EDY PRATAMA SURYA**

STATUS STATUS: **SKEMA PENGHAWAAN ALAMI**

SKALA SCALE: **1:50**  
 BENSAS NO. FILE NO. NAME SIGN DATE

DRAWN BY  
 CHECKED BY  
 Reviewed & Approved by

GAMBAR NO. DRAWING NO.

POSITION NO. TYPE COPYRIGHT OR ARCHITECTURE 2019