

= JALAN PENDUDUK SEKITAR



= TEMPAT PARKIR



الإسلامية
UNIVERSITAS ISLAM INDONESIA

BACHELOR FINAL PROJECT
DEPARTEMENT OF ARCHITECTURE
FACULTY OF CIVIL ENGINEERING
AND
PLANNING

PROJECT

DESIGN OF KOTAGEDE CULTURAL
CENTER IN YOGYAKARTA WITH
ADAPTIVE REUSE AND ADDITION AS
CONSERVATION STRATEGIES

LECTURER

DR. ING- PUTU AYU P. AGUSTIANANDA,
S.T., M.A

NAME

MUHAMAD ARIF SELGI PRABOWO

NIM

15512158

TITLE

SITUASI

SCALE

NO.

TOTAL

INFORMATION

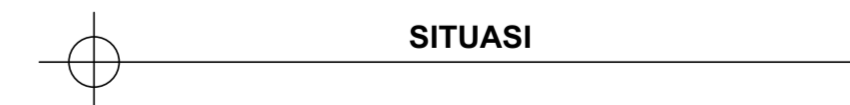
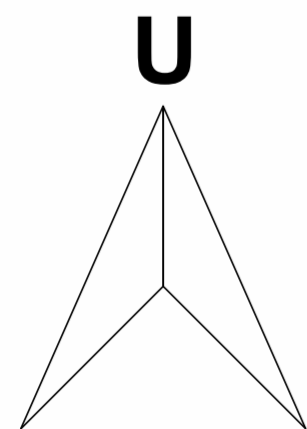

UNIVERSITAS ISLAM INDONESIA
الإسلامية



BACHELOR FINAL PROJECT
 DEPARTEMENT OF ARCHITECTURE
 FACULTY OF CIVIL ENGINEERING
 AND
 PLANNING

PROJECT

DESIGN OF KOTAGEDE CULTURAL
 CENTER IN YOGYAKARTA WITH
 ADAPTIVE REUSE AND ADDITION AS
 CONSERVATION STRATEGIES

LECTURER

DR. ING- PUTU AYU P. AGUSTIANANDA,
 S.T, M.A

NAME

MUHAMAD ARIF SELGI PRABOWO

NIM

15512158

TITLE

SITE PLAN

SCALE

1:200

NO.

TOTAL

INFORMATION

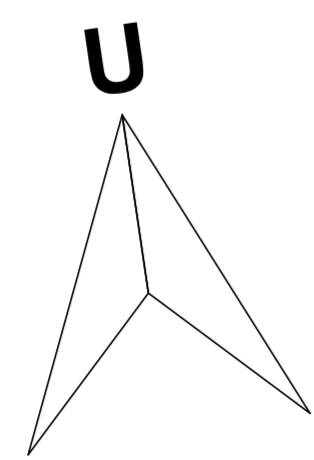
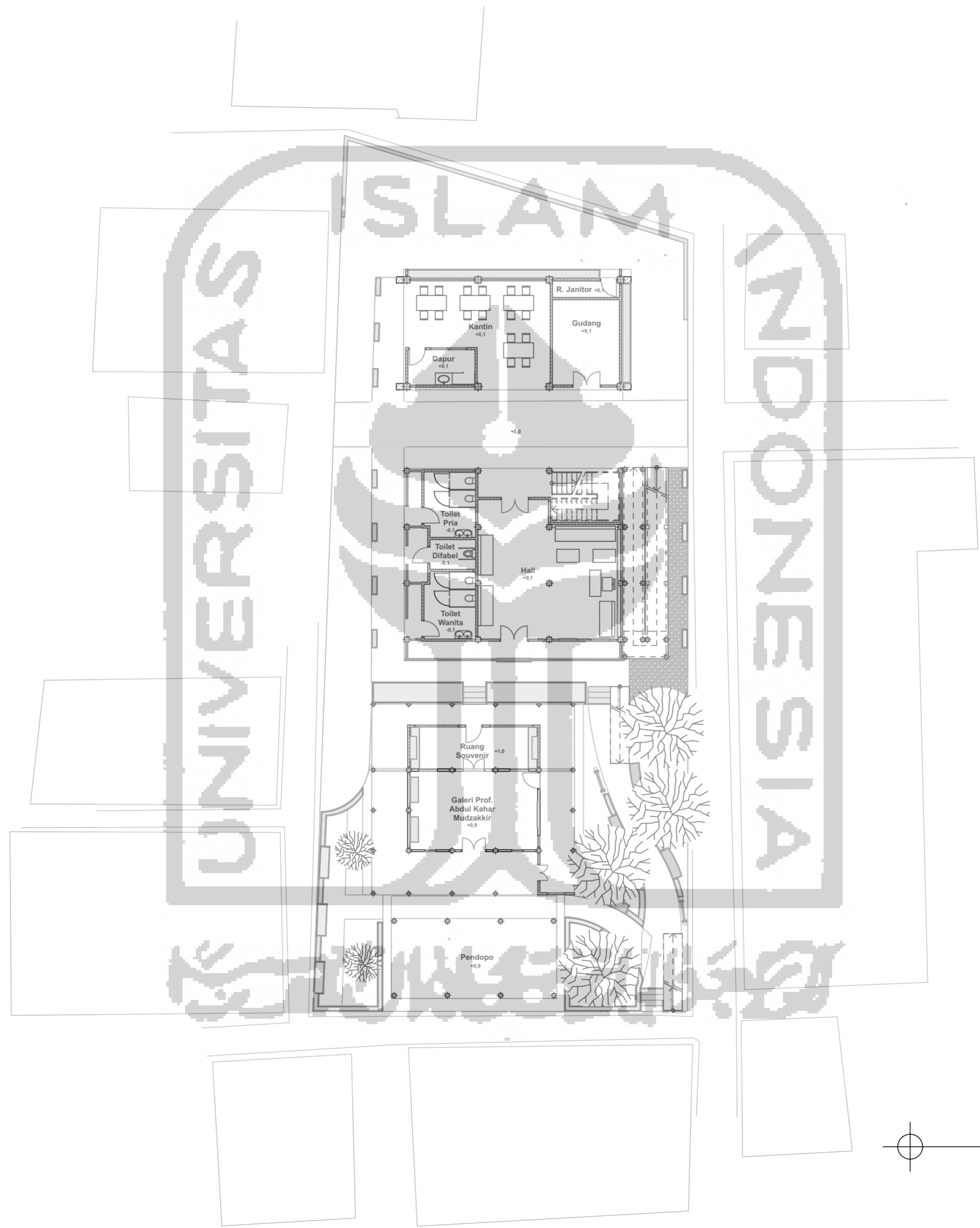

SITE PLAN
 1:200



BACHELOR FINAL PROJECT
 DEPARTEMENT OF ARCHITECTURE
 FACULTY OF CIVIL ENGINEERING
 AND
 PLANNING

PROJECT

DESIGN OF KOTAGEDE CULTURAL
 CENTER IN YOGYAKARTA WITH
 ADAPTIVE REUSE AND ADDITION AS
 CONSERVATION STRATEGIES

LECTURER

DR. ING- PUTU AYU P. AGUSTIANANDA,
 S.T, M.A

NAME

MUHAMAD ARIF SELGI PRABOWO

NIM

15512158

TITLE

DENAH GALERI AKM

SCALE

1:100

NO.	TOTAL

INFORMATION

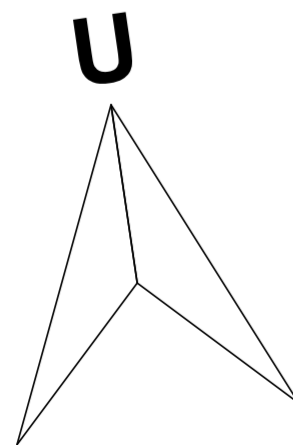
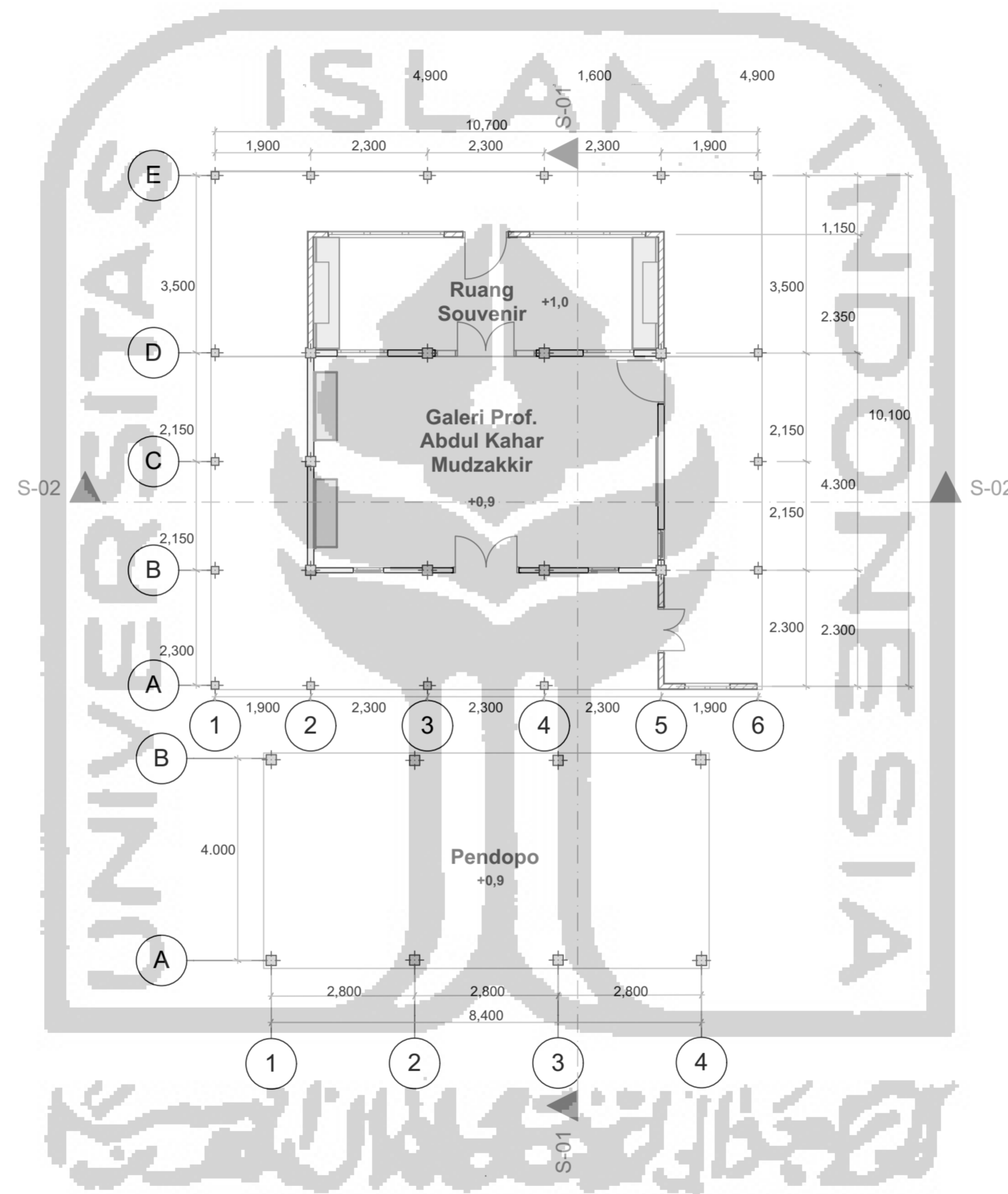

 DENAH GALERI AKM
 1:100



BACHELOR FINAL PROJECT
 DEPARTEMENT OF ARCHITECTURE
 FACULTY OF CIVIL ENGINEERING
 AND
 PLANNING

PROJECT

DESIGN OF KOTAGEDE CULTURAL
 CENTER IN YOGYAKARTA WITH
 ADAPTIVE REUSE AND ADDITION AS
 CONSERVATION STRATEGIES

LECTURER

DR. ING- PUTU AYU P. AGUSTIANANDA,
 S.T, M.A

NAME

MUHAMAD ARIF SELGI PRABOWO

NIM

15512158

TITLE

DENAH PUSAT KEBUDAYAAN LT . 1

SCALE

1:100

NO.	TOTAL

INFORMATION

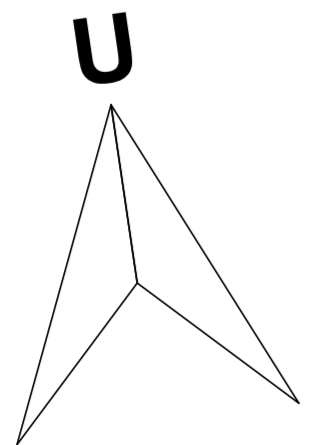
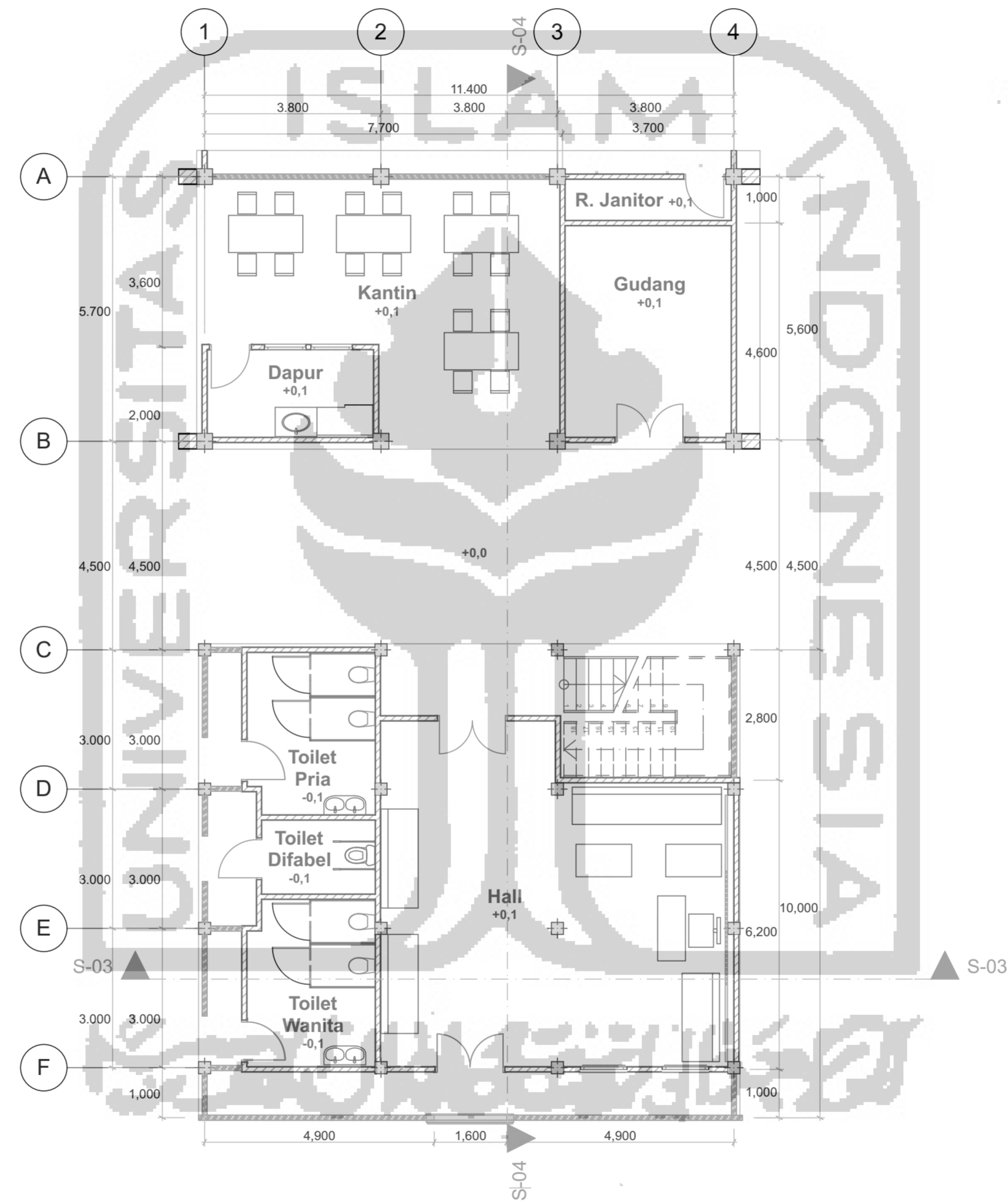

DENAH PUSAT KEBUDAYAAN LT . 1
 1:100



BACHELOR FINAL PROJECT
 DEPARTEMENT OF ARCHITECTURE
 FACULTY OF CIVIL ENGINEERING
 AND
 PLANNING

PROJECT

DESIGN OF KOTAGEDE CULTURAL
 CENTER IN YOGYAKARTA WITH
 ADAPTIVE REUSE AND ADDITION AS
 CONSERVATION STRATEGIES

LECTURER

DR. ING- PUTU AYU P. AGUSTIANANDA,
 S.T, M.A

NAME

MUHAMAD ARIF SELGI PRABOWO

NIM

15512158

TITLE

DENAH PUSAT KEBUDAYAAN LT . 2

SCALE

1:100

NO.

TOTAL

INFORMATION

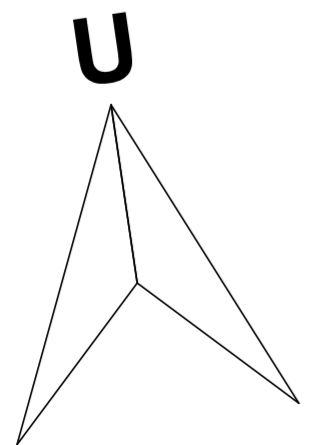
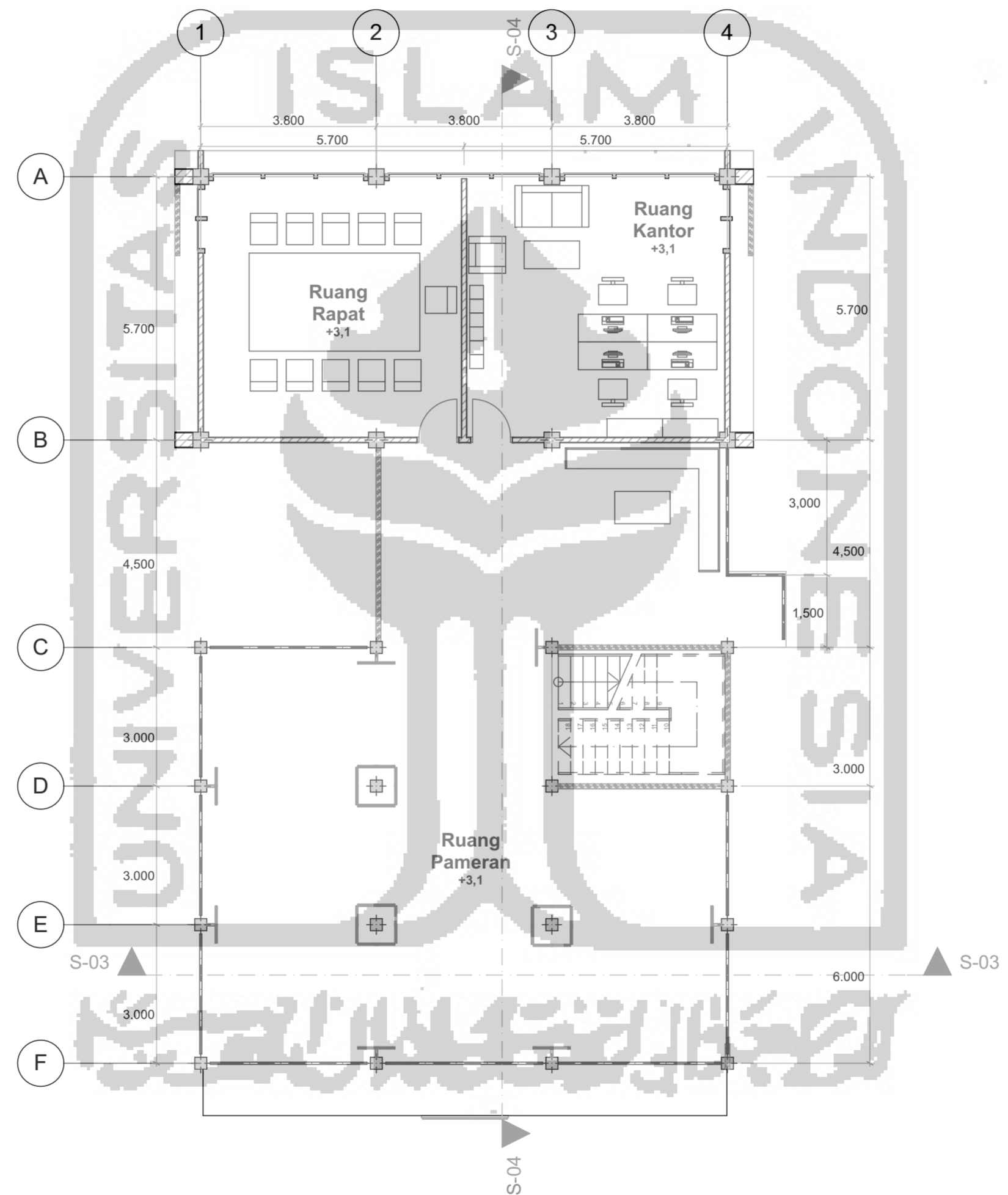

DENAH PUSAT KEBUDAYAAN LT . 2
 1:100



BACHELOR FINAL PROJECT
 DEPARTEMENT OF ARCHITECTURE
 FACULTY OF CIVIL ENGINEERING
 AND
 PLANNING

PROJECT

DESIGN OF KOTAGEDE CULTURAL
 CENTER IN YOGYAKARTA WITH
 ADAPTIVE REUSE AND ADDITION AS
 CONSERVATION STRATEGIES

LECTURER

DR. ING- PUTU AYU P. AGUSTIANANDA,
 S.T, M.A

NAME

MUHAMAD ARIF SELGI PRABOWO

NIM

15512158

TITLE

TAMPAK SELATAN

SCALE

1:100

NO.

TOTAL

INFORMATION

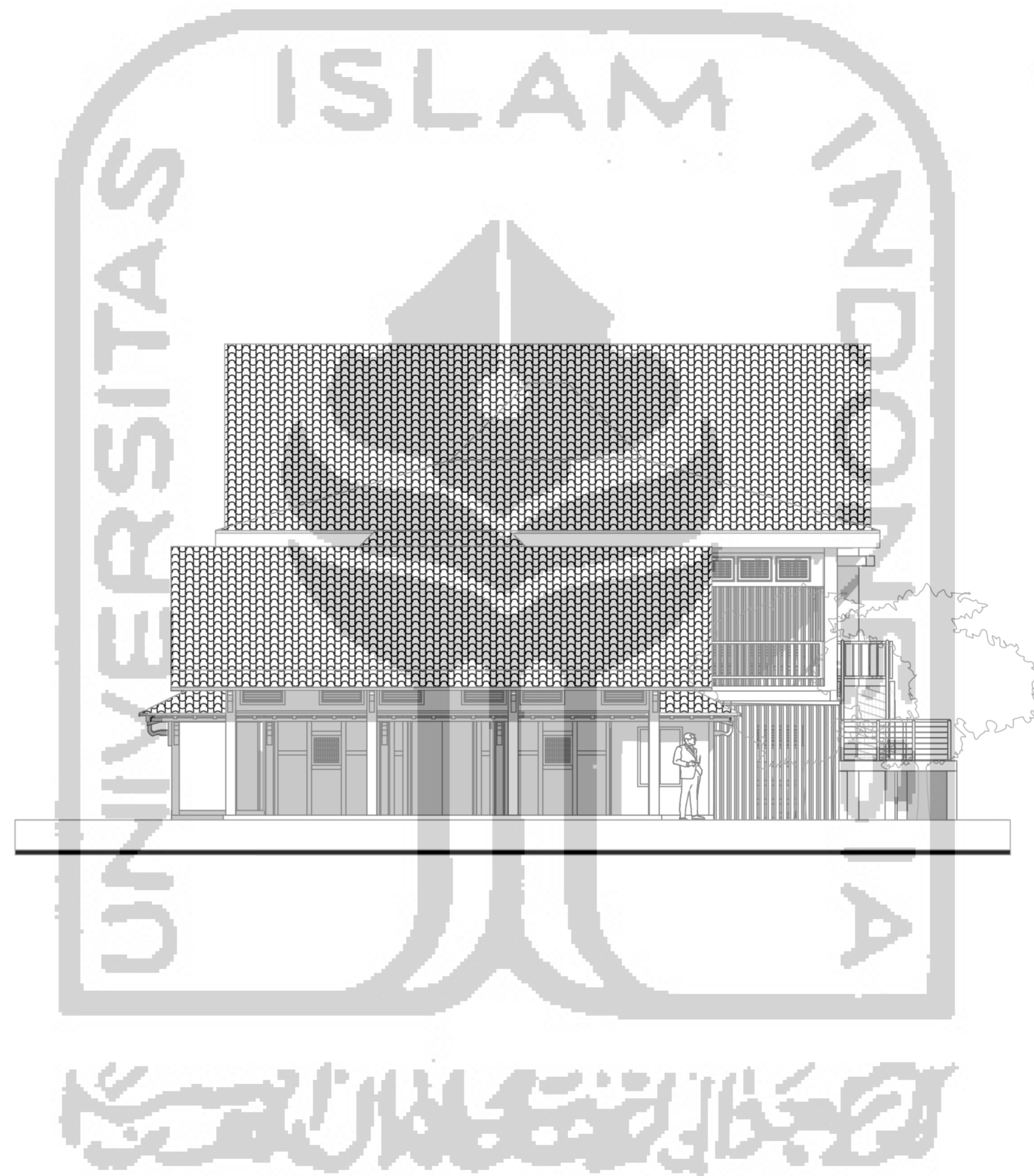

⊕ TAMPAK SELATAN
 1:100



BACHELOR FINAL PROJECT
 DEPARTEMENT OF ARCHITECTURE
 FACULTY OF CIVIL ENGINEERING
 AND
 PLANNING

PROJECT

DESIGN OF KOTAGEDE CULTURAL
 CENTER IN YOGYAKARTA WITH
 ADAPTIVE REUSE AND ADDITION AS
 CONSERVATION STRATEGIES

LECTURER

DR. ING- PUTU AYU P. AGUSTIANANDA,
 S.T., M.A

NAME

MUHAMAD ARIF SELGI PRABOWO

NIM

15512158

TITLE

TAMPAK TIMUR

SCALE

1:100

NO.

TOTAL

INFORMATION

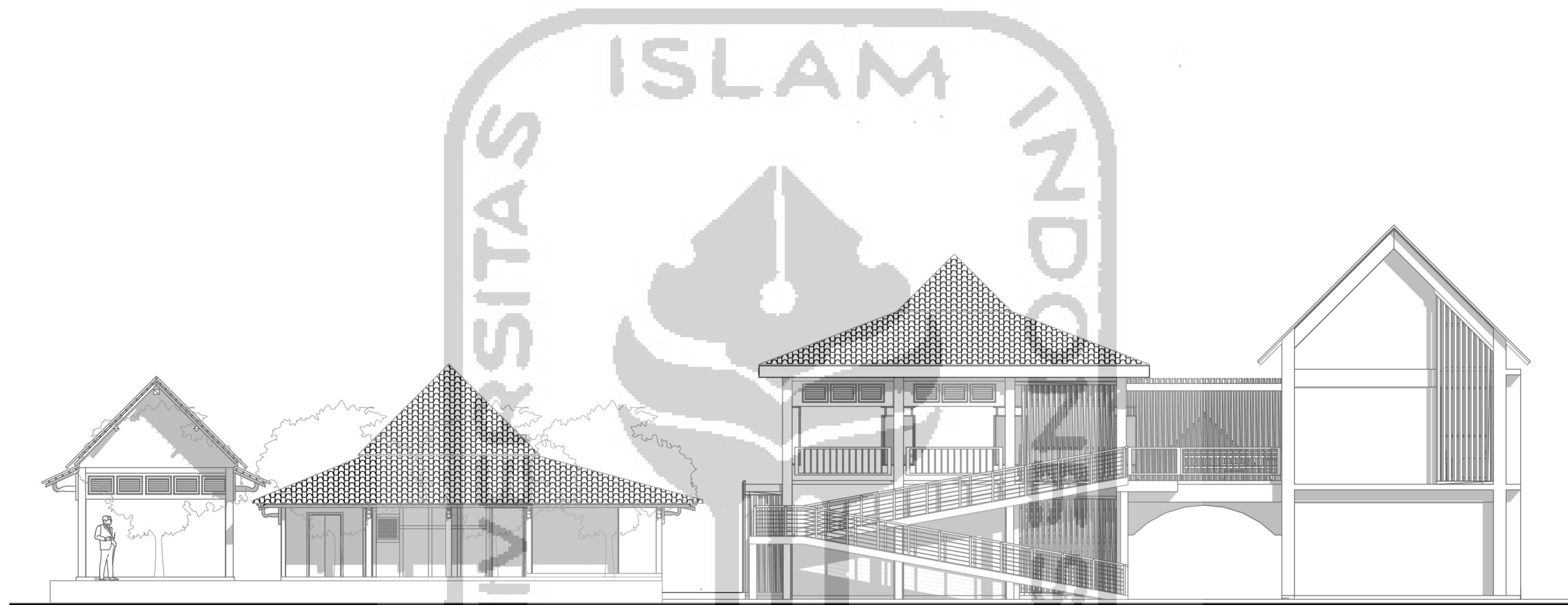



East Elevation

1:100

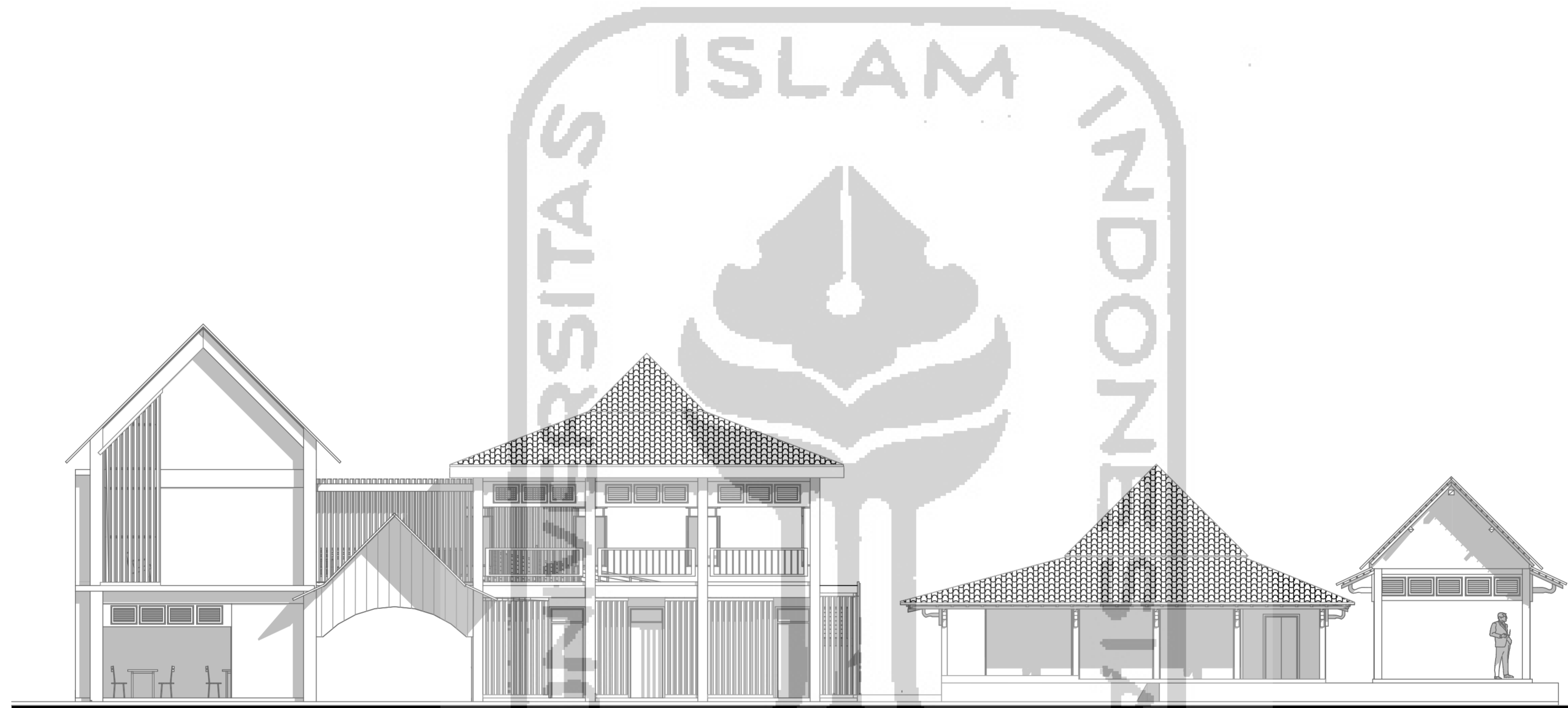

TAMPAK TIMUR
 1:100



TAMPAK BARAT
 1:100

BACHELOR FINAL PROJECT
 DEPARTEMENT OF ARCHITECTURE
 FACULTY OF CIVIL ENGINEERING
 AND
 PLANNING

PROJECT

DESIGN OF KOTAGEDE CULTURAL
 CENTER IN YOGYAKARTA WITH
 ADAPTIVE REUSE AND ADDITION AS
 CONSERVATION STRATEGIES

LECTURER

DR. ING- PUTU AYU P. AGUSTIANANDA,
 S.T., M.A

NAME

MUHAMAD ARIF SELGI PRABOWO

NIM

15512158

TITLE

TAMPAK BARAT

SCALE

1:100

NO.

TOTAL

INFORMATION

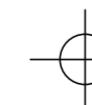
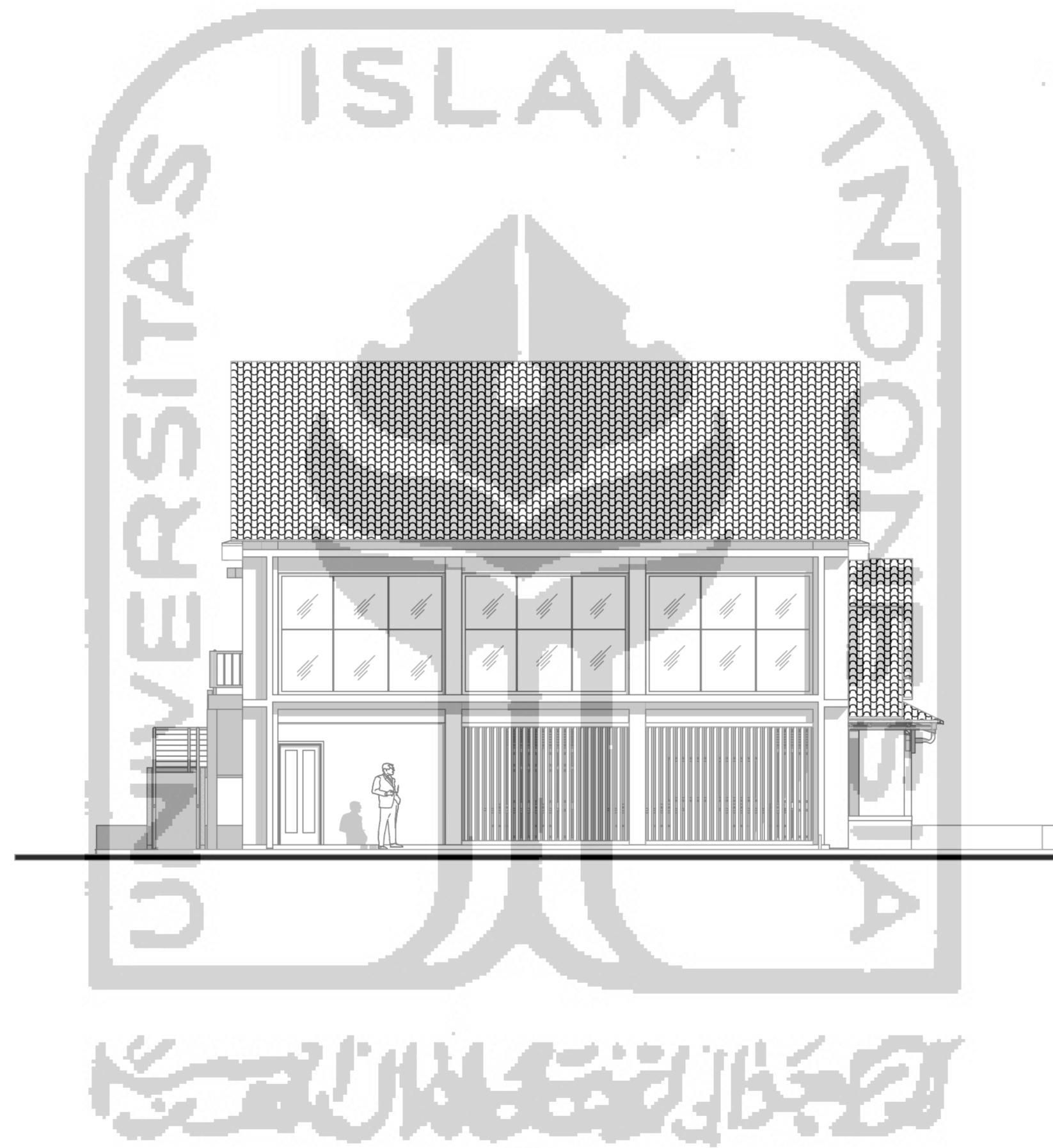

TAMPAK UTARA
1:100

BACHELOR FINAL PROJECT
DEPARTEMENT OF ARCHITECTURE
FACULTY OF CIVIL ENGINEERING
AND
PLANNING

PROJECT

DESIGN OF KOTAGEDE CULTURAL
CENTER IN YOGYAKARTA WITH
ADAPTIVE REUSE AND ADDITION AS
CONSERVATION STRATEGIES

LECTURER

DR. ING- PUTU AYU P. AGUSTIANANDA,
S.T, M.A

NAME

MUHAMAD ARIF SELGI PRABOWO

NIM

15512158

TITLE

TAMPAK UTARA

SCALE

1:100

NO.

TOTAL

INFORMATION



الجامعة الإسلامية
INDONESIA

BACHELOR FINAL PROJECT
DEPARTEMENT OF ARCHITECTURE
FACULTY OF CIVIL ENGINEERING
AND
PLANNING

PROJECT

DESIGN OF KOTAGEDE CULTURAL
CENTER IN YOGYAKARTA WITH
ADAPTIVE REUSE AND ADDITION AS
CONSERVATION STRATEGIES

LECTURER

DR. ING- PUTU AYU P. AGUSTIANANDA,
S.T., M.A

NAME

MUHAMAD ARIF SELGI PRABOWO

NIM

15512158

TITLE

DENAH GALERI AKM

SCALE

1:100

NO.

TOTAL

INFORMATION

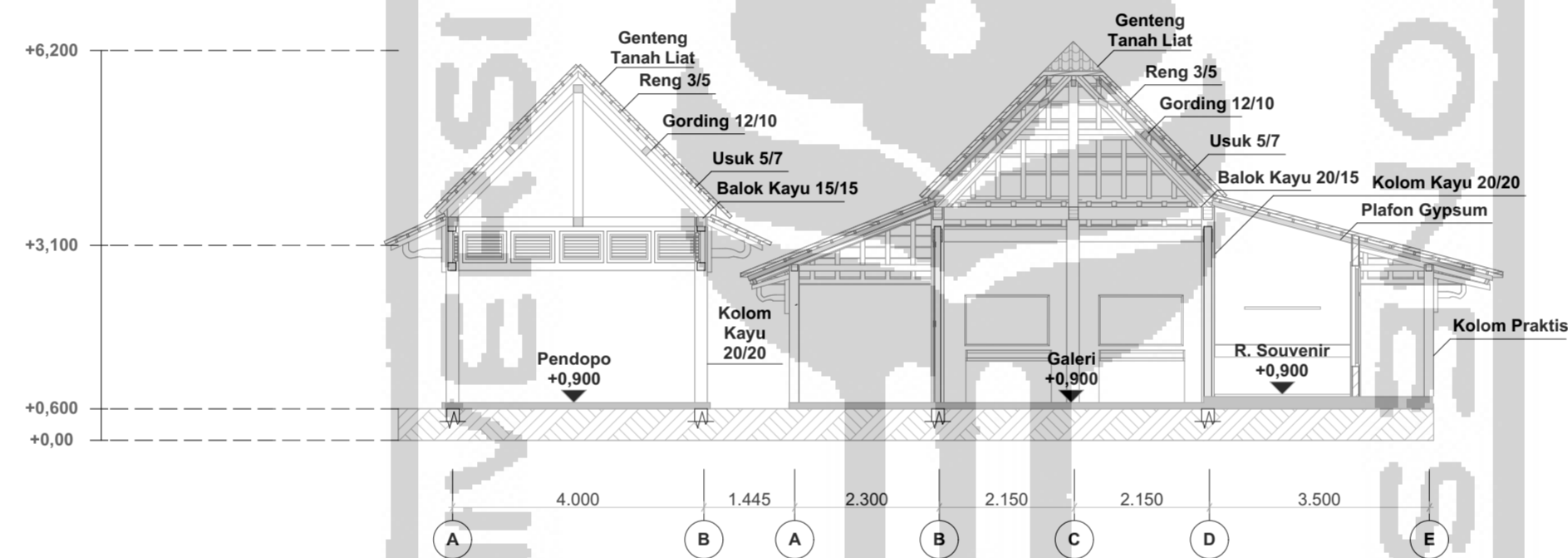

S-01

Building Section (2)

1:100

U

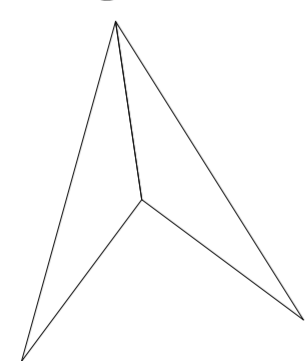

POTONGAN S-01

1:100



BACHELOR FINAL PROJECT
 DEPARTEMENT OF ARCHITECTURE
 FACULTY OF CIVIL ENGINEERING
 AND
 PLANNING

PROJECT

DESIGN OF KOTAGEDE CULTURAL
 CENTER IN YOGYAKARTA WITH
 ADAPTIVE REUSE AND ADDITION AS
 CONSERVATION STRATEGIES

LECTURER

DR. ING- PUTU AYU P. AGUSTIANANDA,
 S.T, M.A

NAME

MUHAMAD ARIF SELGI PRABOWO

NIM

15512158

TITLE

POTONGAN S-02

SCALE

1:100

NO.	TOTAL

INFORMATION

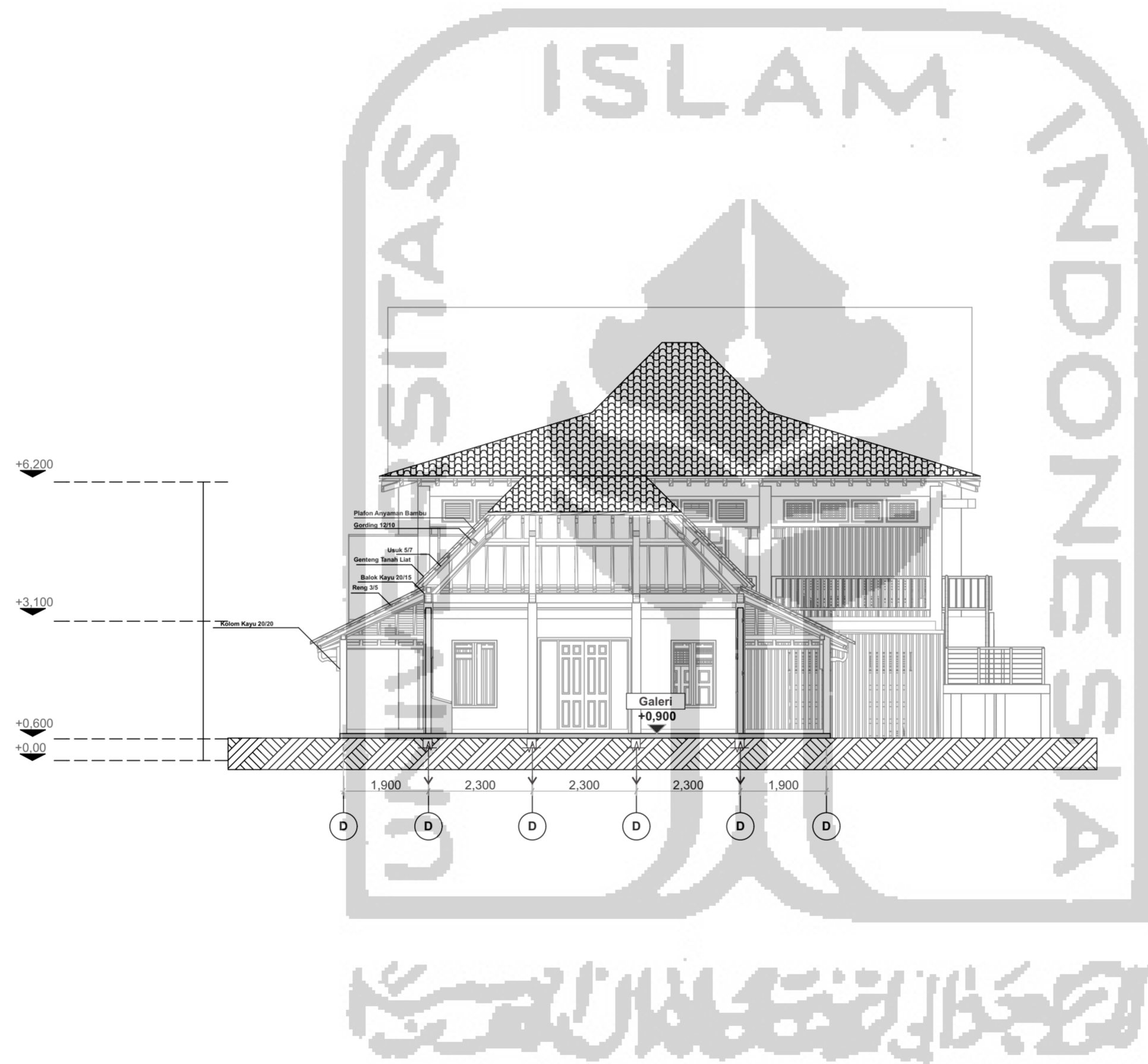

 **POTONGAN S-02**
 1:100



BACHELOR FINAL PROJECT
 DEPARTEMENT OF ARCHITECTURE
 FACULTY OF CIVIL ENGINEERING
 AND PLANNING

PROJECT

DESIGN OF KOTAGEDE CULTURAL
 CENTER IN YOGYAKARTA WITH
 ADAPTIVE REUSE AND ADDITION AS
 CONSERVATION STRATEGIES

LECTURER

DR. ING- PUTU AYU P. AGUSTIANANDA,
 S.T, M.A

NAME

MUHAMAD ARIF SELGI PRABOWO

NIM

15512158

TITLE

DENAH GALERI AKM

SCALE

1:100

NO.

TOTAL

INFORMATION

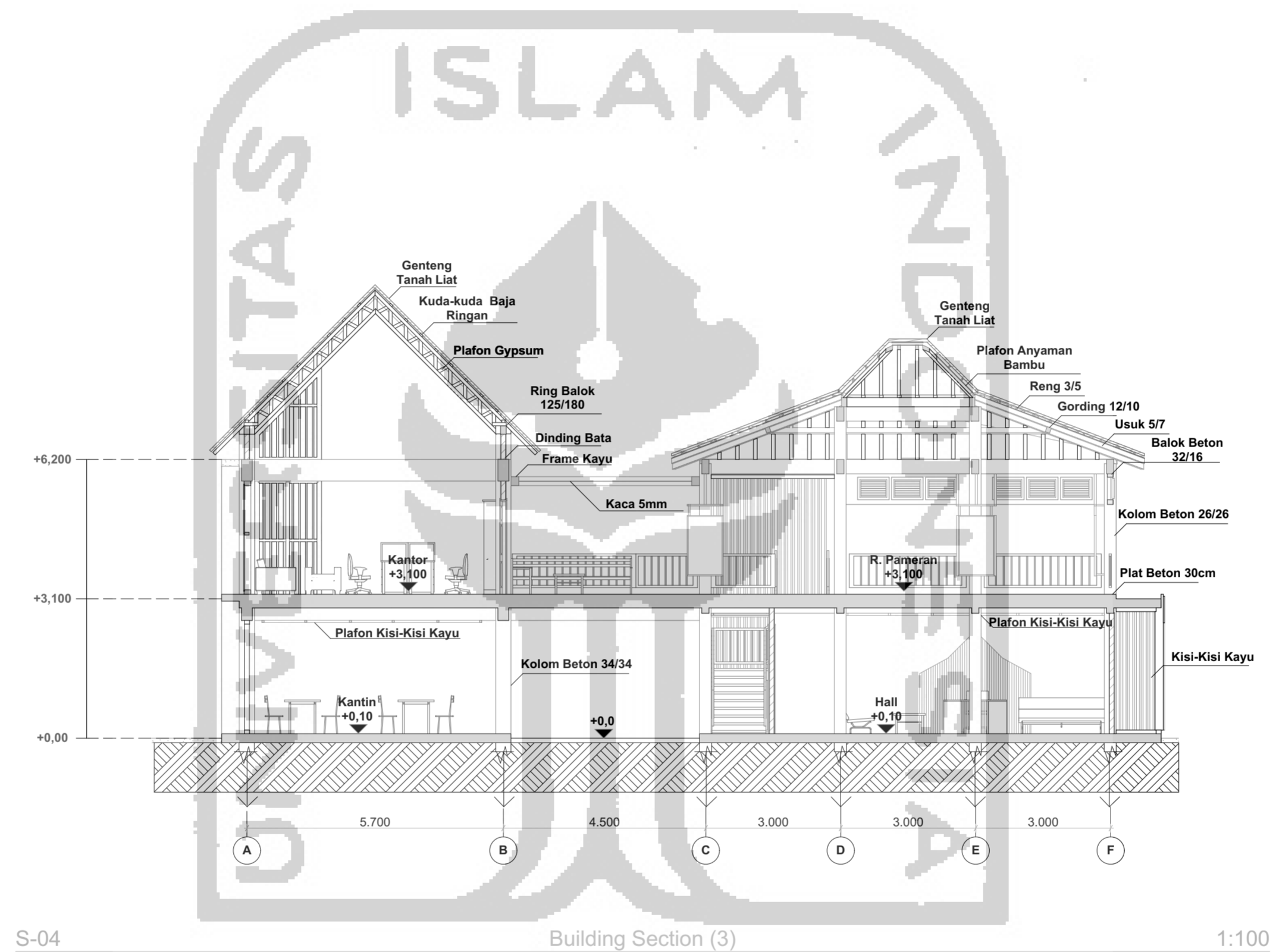

POTONGAN S-04
 1:100



BACHELOR FINAL PROJECT
DEPARTMENT OF ARCHITECTURE
FACULTY OF CIVIL ENGINEERING
AND
PLANNING

PROJECT

DESIGN OF KOTAGEDE CULTURAL
CENTER IN YOGYAKARTA WITH
ADAPTIVE REUSE AND ADDITION AS
CONSERVATION STRATEGIES

LECTURER

DR. ING- PUTU AYU P. AGUSTIANANDA,
S.T., M.A

NAME

MUHAMAD ARIF SELGI PRABOWO

NIM

15512158

TITLE

DENAH PARSIAL PUSAT KEBUDAYAAN

SCALE

1:100

NO.

TOTAL

INFORMATION

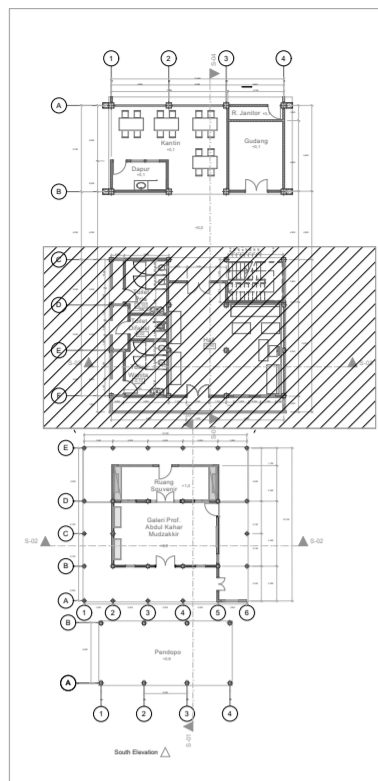

KEY PLAN

0. Ground Floor (1:500)

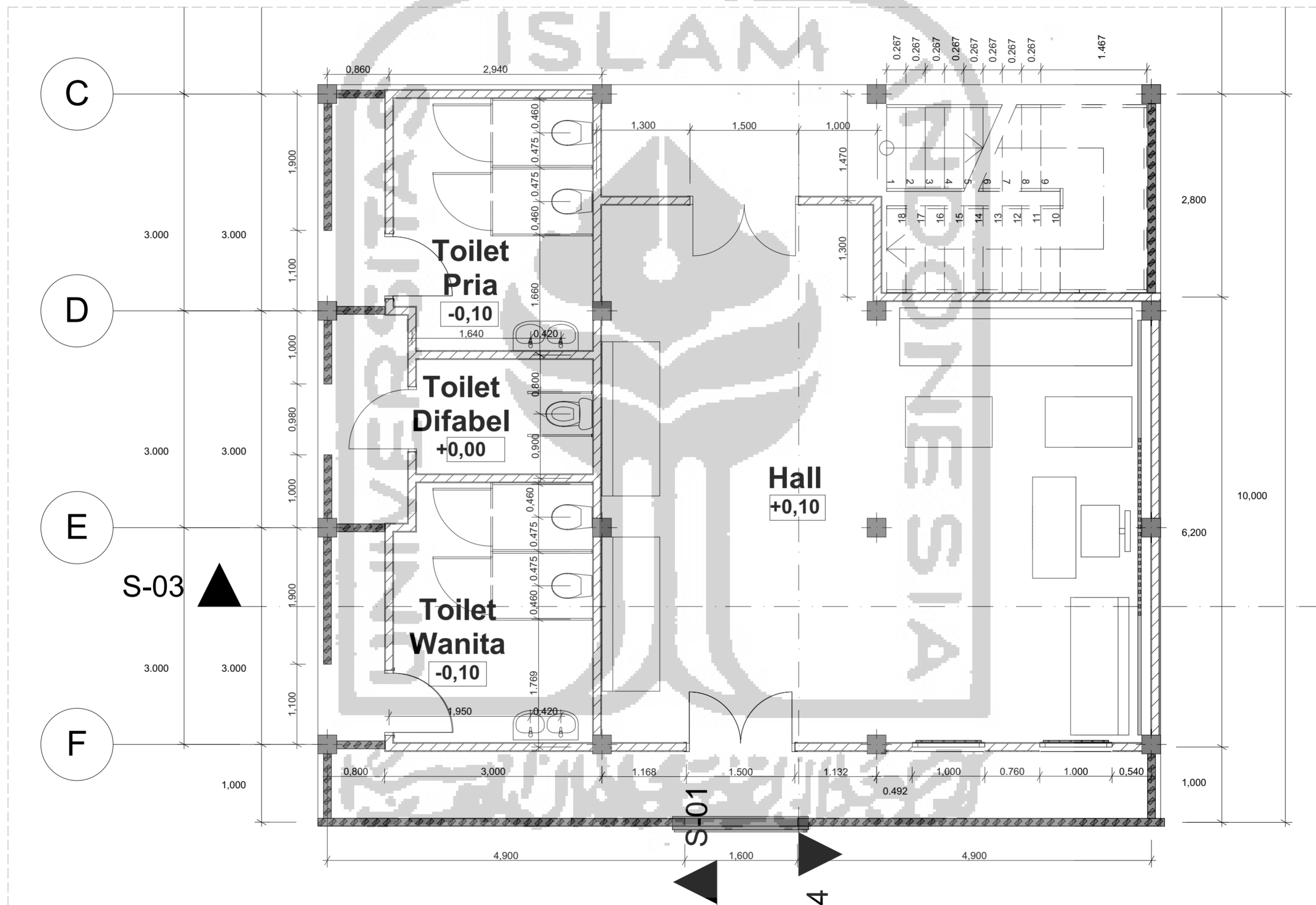

0. Ground Floor

1:50



DENAH PARSIAL PUSAT KEBUDAYAAN

1:50



BACHELOR FINAL PROJECT
 DEPARTEMENT OF ARCHITECTURE
 FACULTY OF CIVIL ENGINEERING
 AND PLANNING

PROJECT

DESIGN OF KOTAGEDE CULTURAL
 CENTER IN YOGYAKARTA WITH
 ADAPTIVE REUSE AND ADDITION AS
 CONSERVATION STRATEGIES

LECTURER

DR. ING- PUTU AYU P. AGUSTIANANDA,
 S.T., M.A

NAME

MUHAMAD ARIF SELGI PRABOWO

NIM

15512158

TITLE

DENAH PARSIAL GALERI

SCALE

1:50

NO.

TOTAL

INFORMATION

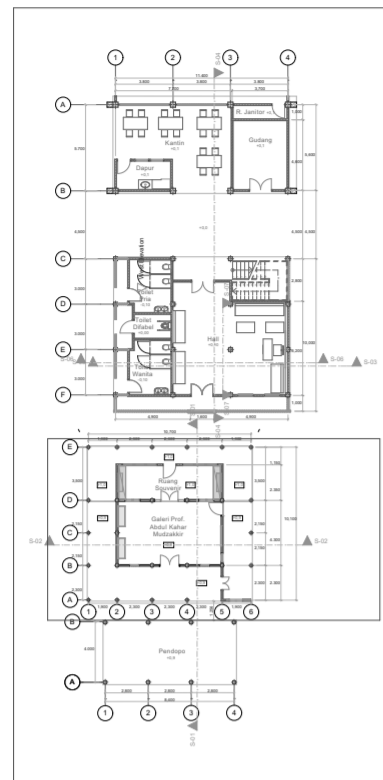

KEY PLAN

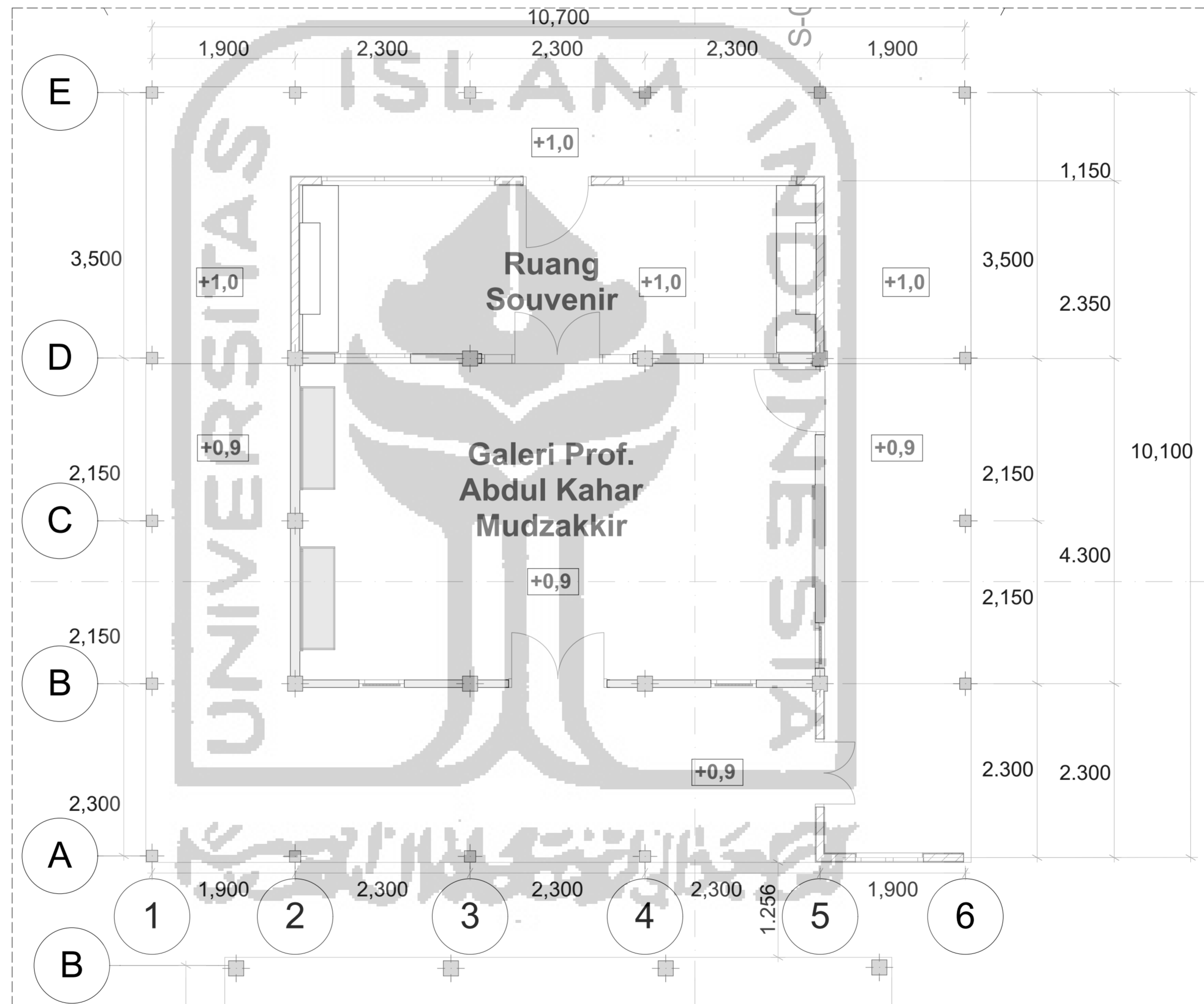

DENAH PARSIAL GALERI
 1:50

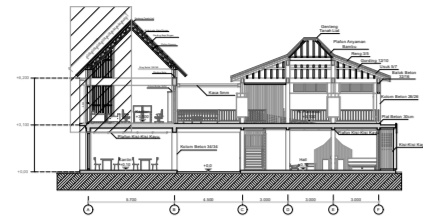

KEY PLAN

S-04 Building Section (7) 1:500

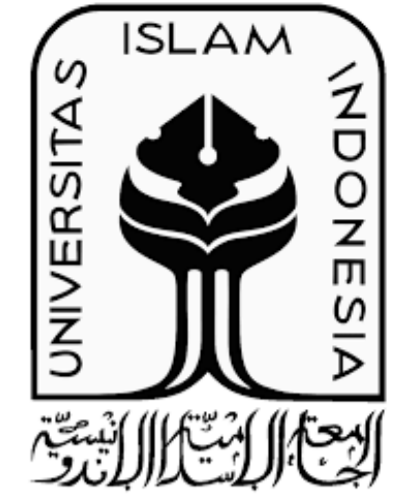
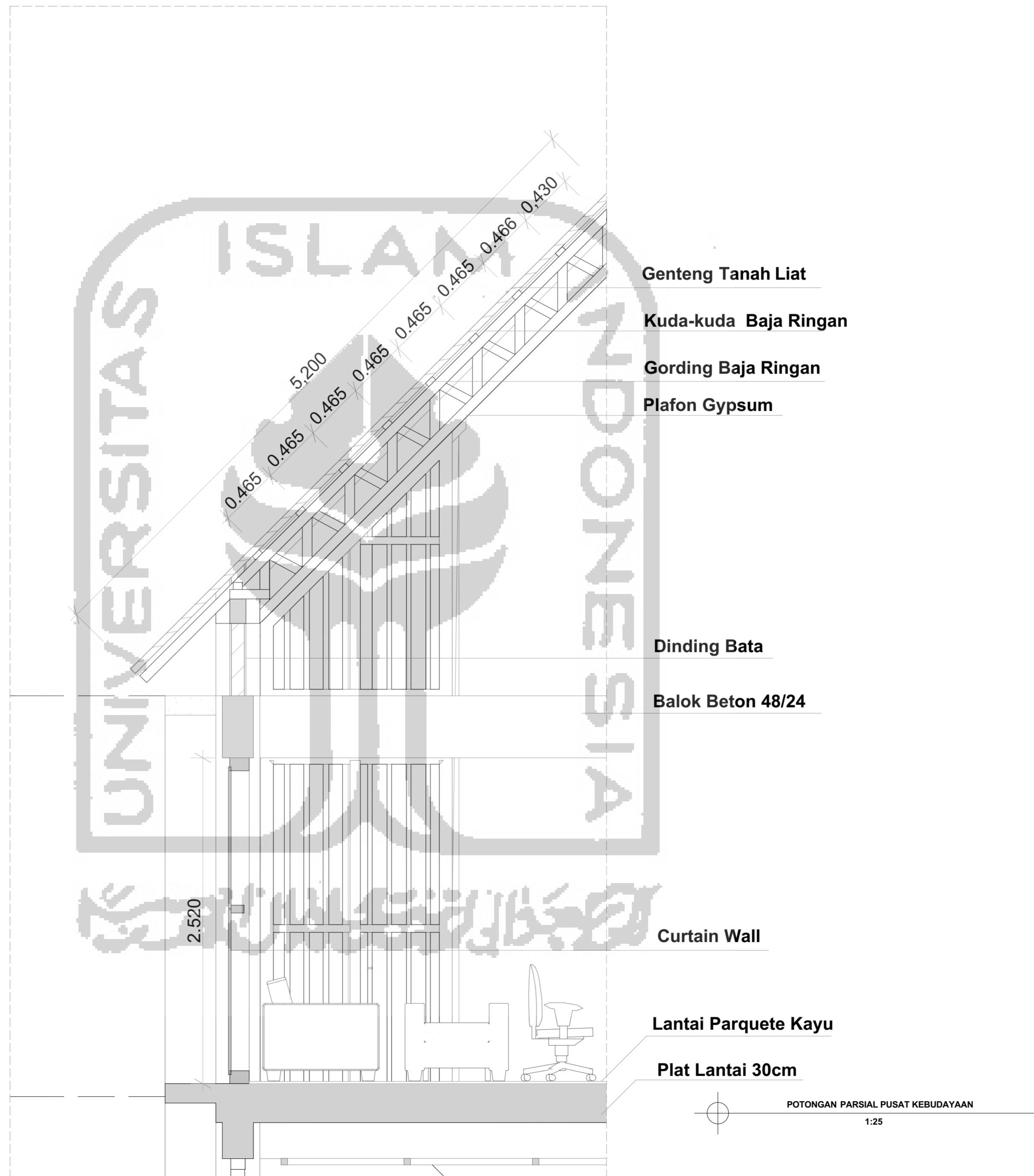

BACHELOR FINAL PROJECT
 DEPARTEMENT OF ARCHITECTURE
 FACULTY OF CIVIL ENGINEERING
 AND
 PLANNING

PROJECT

DESIGN OF KOTAGEDE CULTURAL
 CENTER IN YOGYAKARTA WITH
 ADAPTIVE REUSE AND ADDITION AS
 CONSERVATION STRATEGIES

LECTURER

DR. ING- PUTU AYU P. AGUSTIANANDA,
 S.T., M.A

NAME

MUHAMAD ARIF SELGI PRABOWO

NIM

15512158

TITLE

POTONGAN PARSIAL PUSAT
 KEBUDAYAAN

SCALE

1:25

NO.	TOTAL

INFORMATION

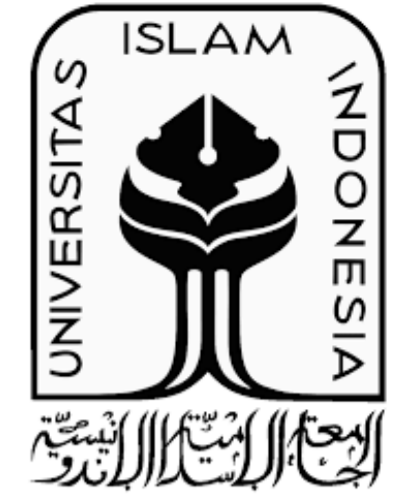

BACHELOR FINAL PROJECT
 DEPARTEMENT OF ARCHITECTURE
 FACULTY OF CIVIL ENGINEERING
 AND PLANNING

PROJECT

DESIGN OF KOTAGEDE CULTURAL
 CENTER IN YOGYAKARTA WITH
 ADAPTIVE REUSE AND ADDITION AS
 CONSERVATION STRATEGIES

LECTURER

DR. ING- PUTU AYU P. AGUSTIANANDA,
 S.T., M.A

NAME

MUHAMAD ARIF SELGI PRABOWO

NIM

15512158

TITLE

PERSPEKTIF INTERIOR

SCALE

NO.	TOTAL

INFORMATION

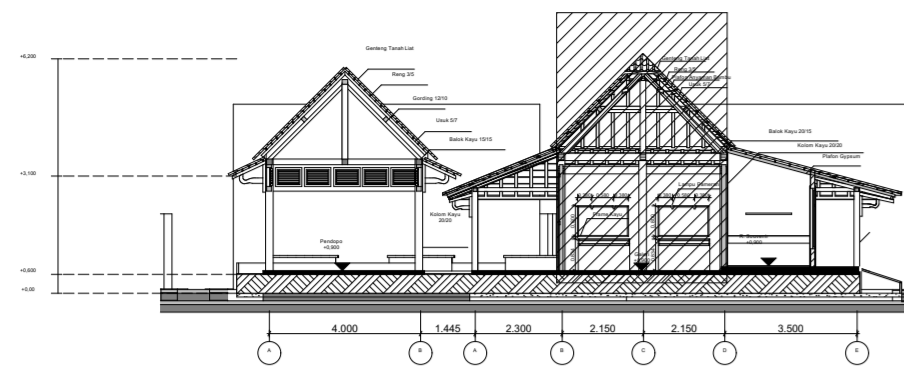

KEY PLAN

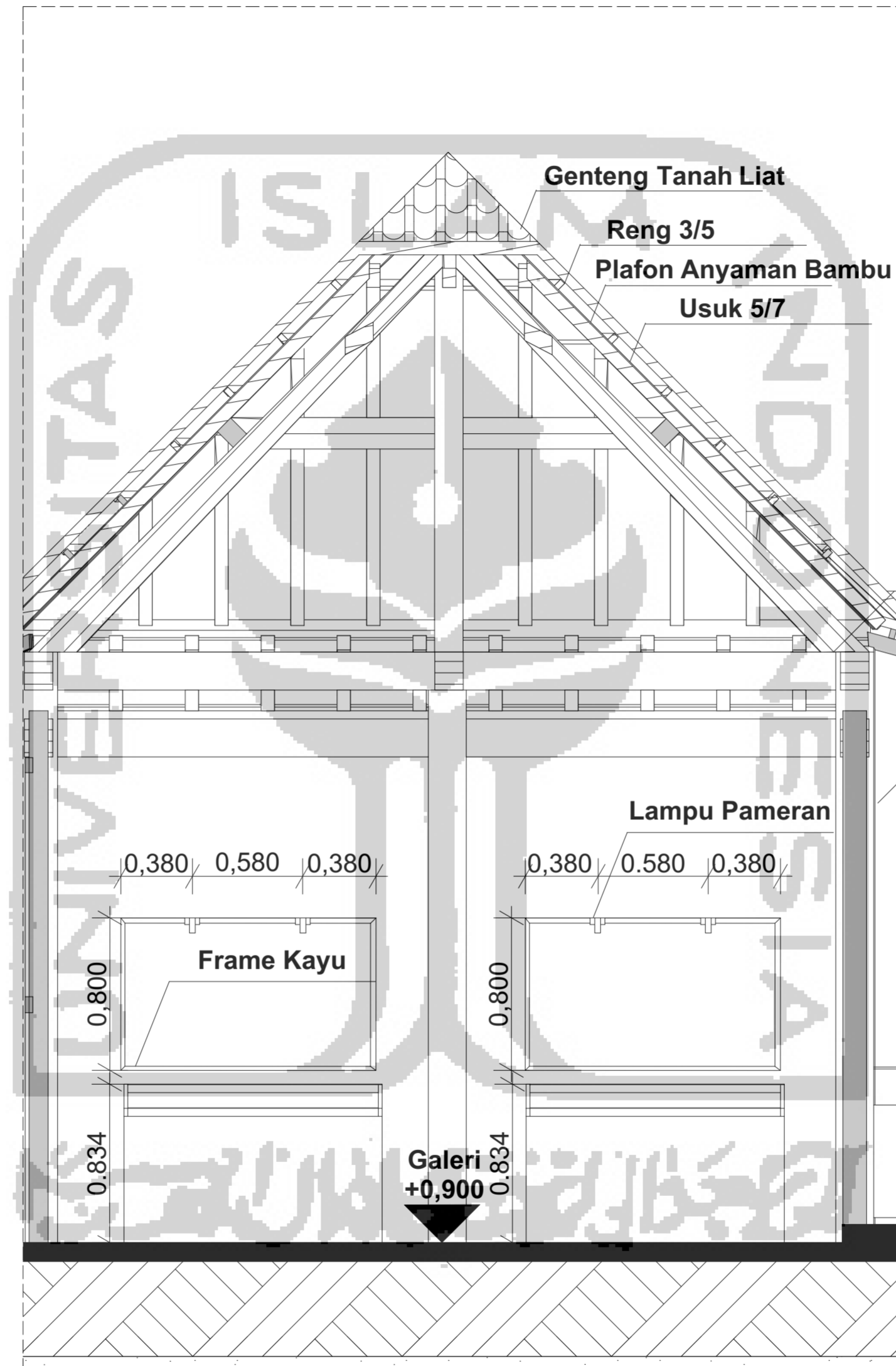



BACHELOR FINAL PROJECT
 DEPARTEMENT OF ARCHITECTURE
 FACULTY OF CIVIL ENGINEERING
 AND
 PLANNING

PROJECT

DESIGN OF KOTAGEDE CULTURAL
 CENTER IN YOGYAKARTA WITH
 ADAPTIVE REUSE AND ADDITION AS
 CONSERVATION STRATEGIES

LECTURER

DR. ING- PUTU AYU P. AGUSTIANANDA,
 S.T., M.A

NAME

MUHAMAD ARIF SELGI PRABOWO

NIM

15512158

TITLE

SISTEM STRUKTUR

SCALE

NO.

TOTAL

INFORMATION

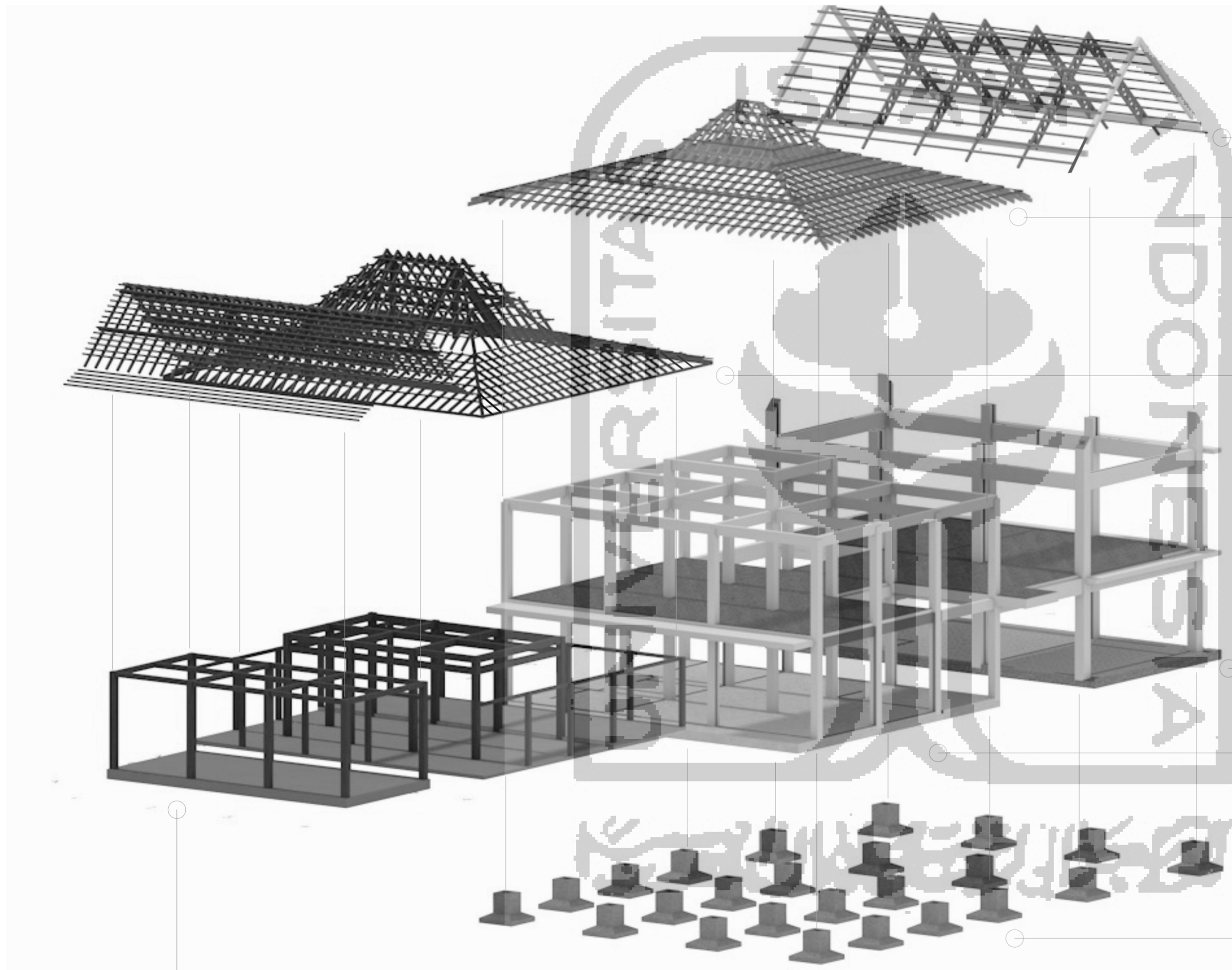

Kuda-kuda dan Rangka
 Atap Baja Ringan

Rangka Atap Kayu

Rangka Atap Kayu

Kolom Beton 34/34
 Balok Beton 48/24
 Plat Beton 30cm

Kolom Beton 26/26
 Balok Beton 32/16
 Plat Beton 30cm

Pondasi Titik

Kolom Kayu 20/20
 Balok Kayu 15/15
 Plat Beton 10cm



SISTEM STRUKTUR

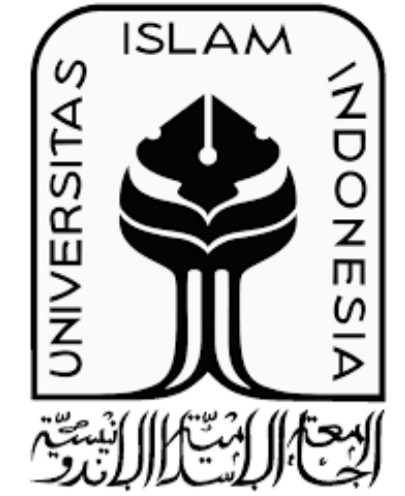

BACHELOR FINAL PROJECT
 DEPARTEMENT OF ARCHITECTURE
 FACULTY OF CIVIL ENGINEERING
 AND PLANNING

PROJECT

DESIGN OF KOTAGEDE CULTURAL
 CENTER IN YOGYAKARTA WITH
 ADAPTIVE REUSE AND ADDITION AS
 CONSERVATION STRATEGIES

LECTURER

DR. ING- PUTU AYU P. AGUSTIANANDA,
 S.T, M.A

NAME

MUHAMAD ARIF SELGI PRABOWO

NIM

15512158

TITLE

POTONGAN TAMPAK PUSAT
 KEBUDAYAAN

SCALE

1:25

NO.	TOTAL

INFORMATION



6 West Elevation (3) 1:500

KEY PLAN

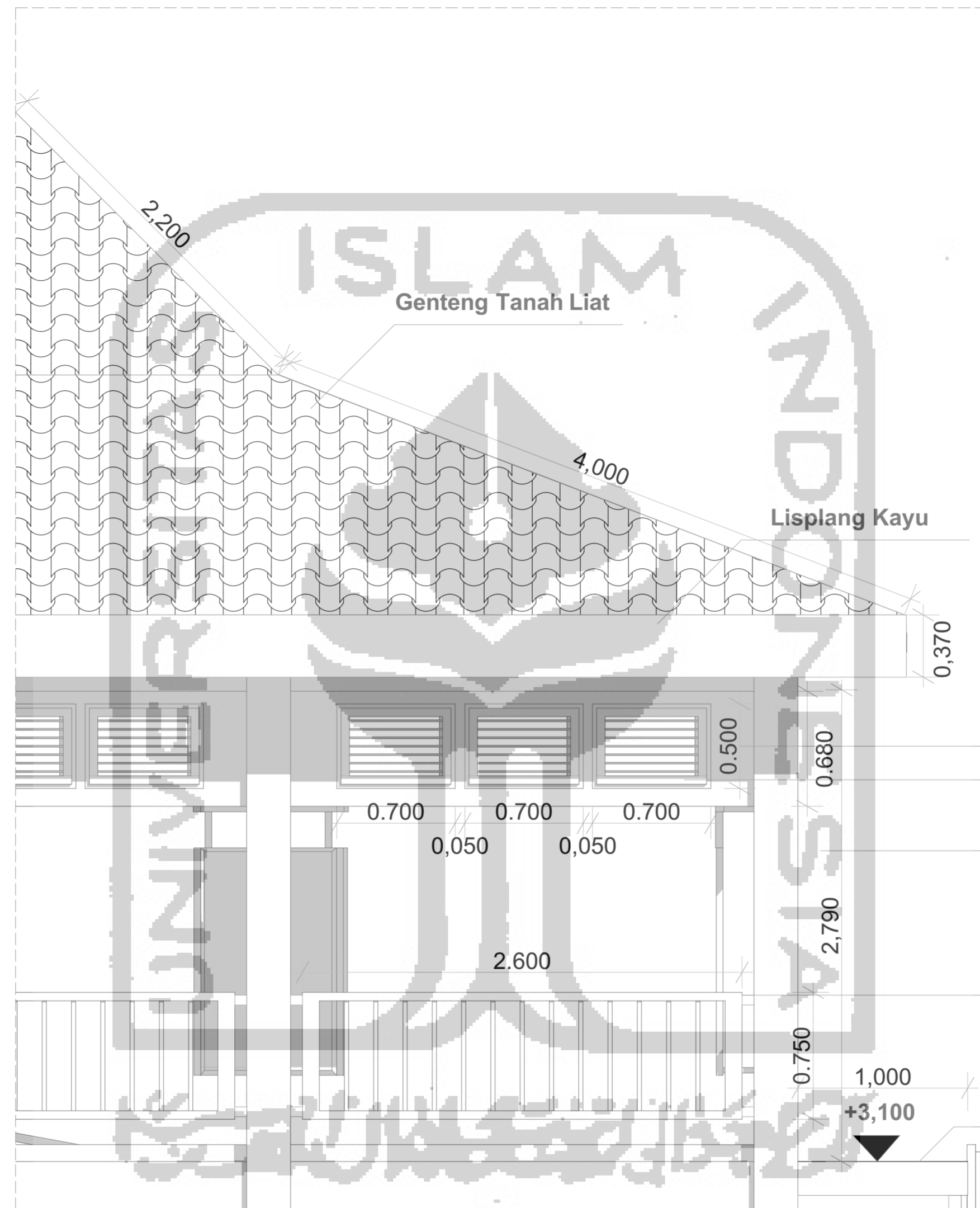

Kayu
 Kisi-kisi Kayu

Kolom Beton 26/26

Railing Kayu

Plat Beton 30cm

6

West Elevation (2)

1:25



POTONGAN TAMPAK PUSAT KEBUDAYAAN

1:25

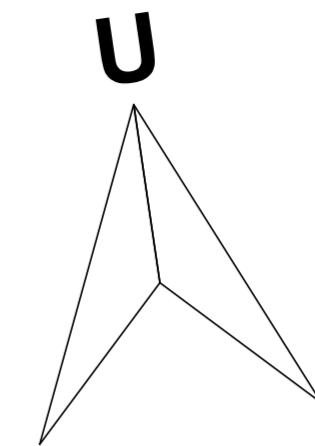

BACHELOR FINAL PROJECT
 DEPARTEMENT OF ARCHITECTURE
 FACULTY OF CIVIL ENGINEERING
 AND
 PLANNING

PROJECT

DESIGN OF KOTAGEDE CULTURAL
 CENTER IN YOGYAKARTA WITH
 ADAPTIVE REUSE AND ADDITION AS
 CONSERVATION STRATEGIES

LECTURER

DR. ING- PUTU AYU P. AGUSTIANANDA
 S.T., M.A

NAME

MUHAMAD ARIF SELGI PRABOWO

NIM

15512158

TITLE

SKEMA AIR BERSIH 2

SCALE

1:100

NO.	TOTAL

INFORMATION

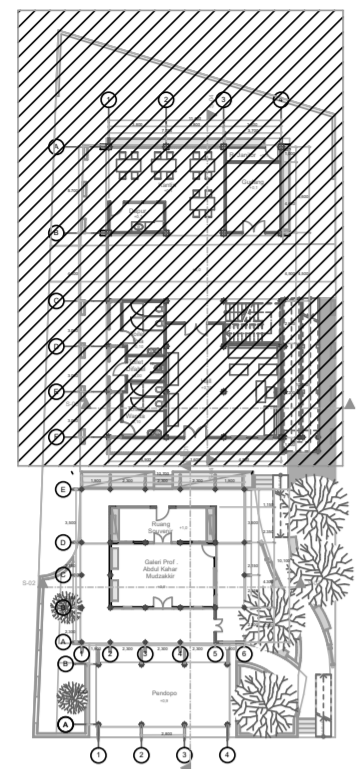

KEY PLAN

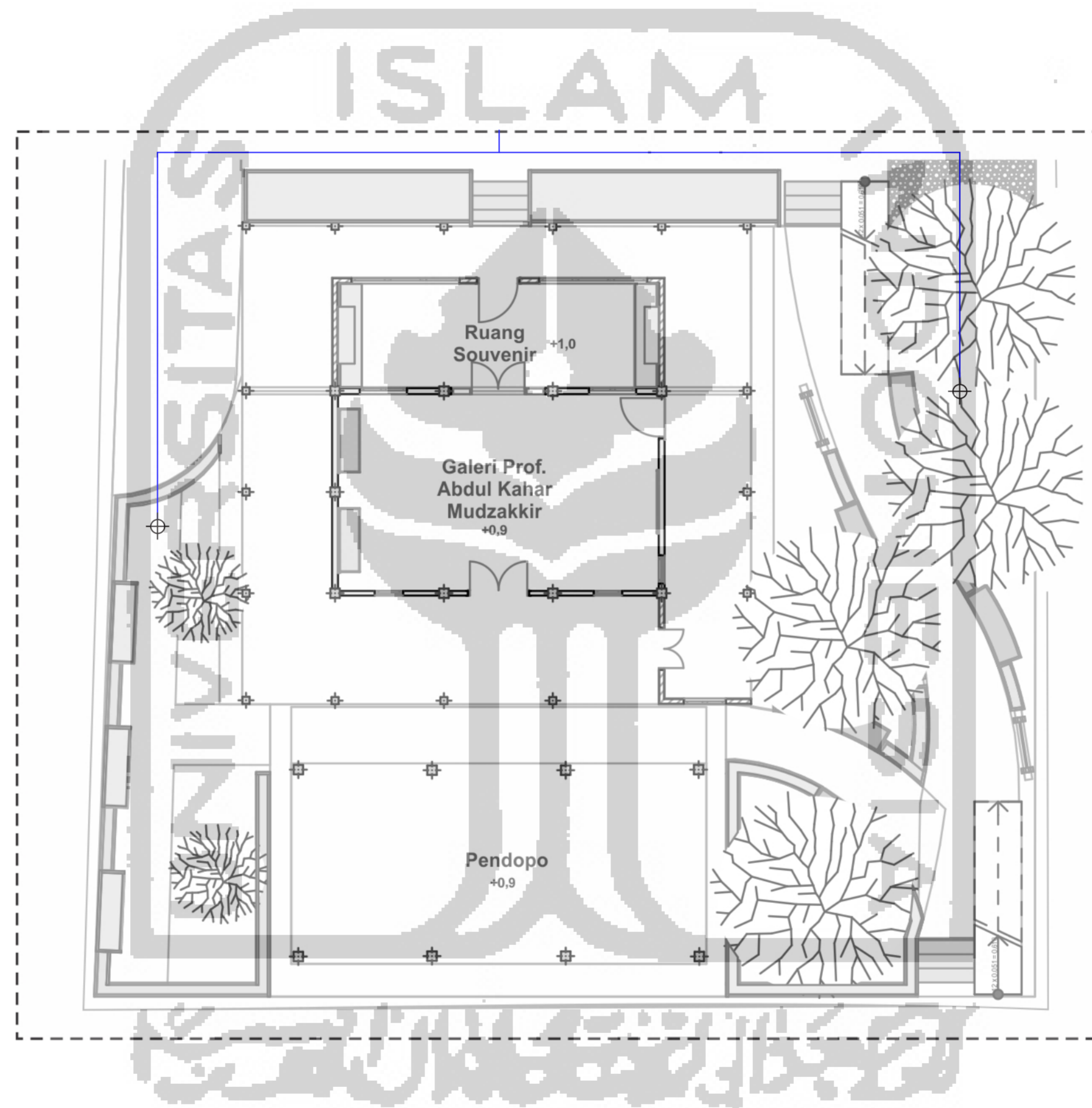

LEGENDA

-  KRAN AIR
-  PIPA AIR BERSIH

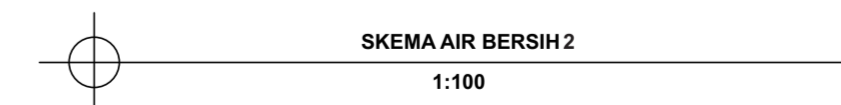



BACHELOR FINAL PROJECT
DEPARTEMENT OF ARCHITECTURE
FACULTY OF CIVIL ENGINEERING
AND PLANNING

PROJECT

DESIGN OF KOTAGEDE CULTURAL
CENTER IN YOGYAKARTA WITH
ADAPTIVE REUSE AND ADDITION AS
CONSERVATION STRATEGIES

LECTURER

DR. ING- PUTU AYU P. AGUSTIANANDA
S.T, M.A

NAME

MUHAMAD ARIF SELGI PRABOWO

NIM

15512158

TITLE

SKEMA AIR BERSIH

SCALE

1:100

NO.

TOTAL

INFORMATION

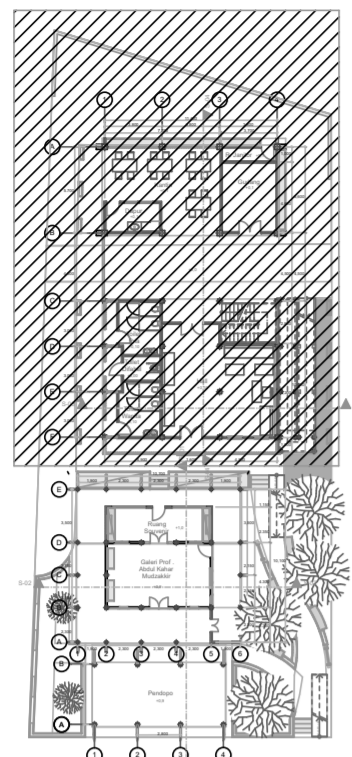

KEY PLAN

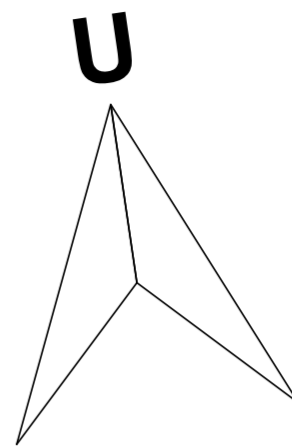
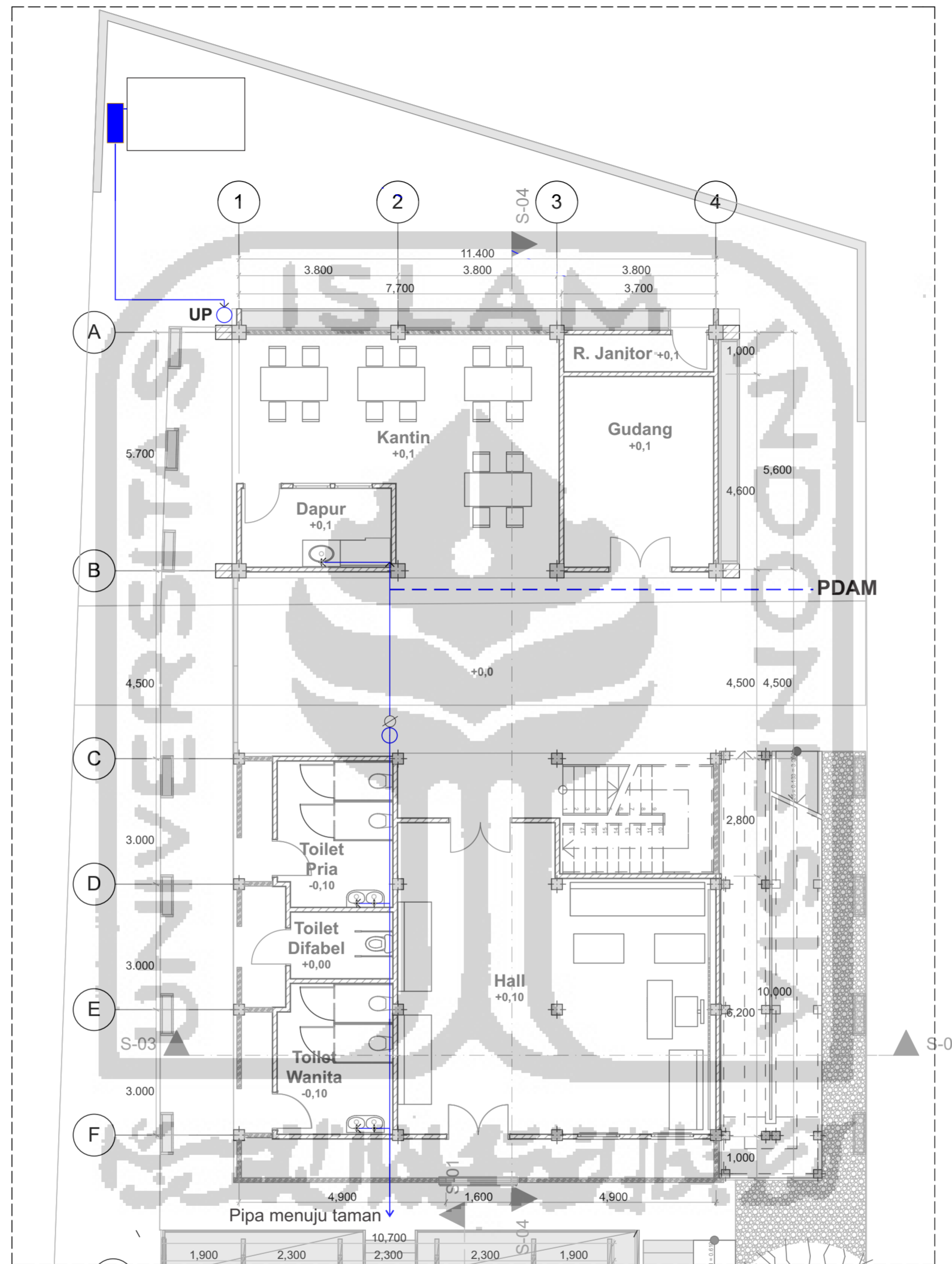

SKEMA AIR BERSIH
1:100

LEGENDA	
	PIPA MENUJU ROOF TANK
	KRAN AIR
	PIPA AIR BERSIH
	AIR DARI PDAM
	POMPA AIR
	KATUP AIR
	SUMUR PENAMPUNGAN

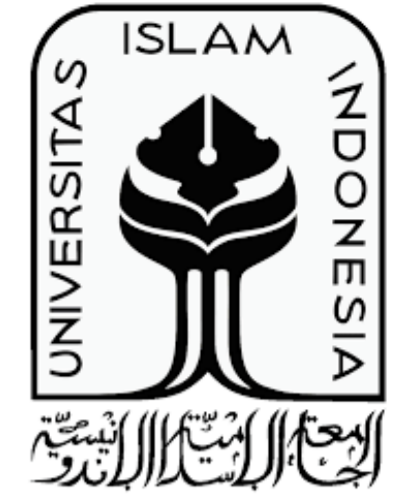

BACHELOR FINAL PROJECT
DEPARTEMENT OF ARCHITECTURE
FACULTY OF CIVIL ENGINEERING
AND
PLANNING

PROJECT

DESIGN OF KOTAGEDE CULTURAL
CENTER IN YOGYAKARTA WITH
ADAPTIVE REUSE AND ADDITION AS
CONSERVATION STRATEGIES

LECTURER

DR. ING- PUTU AYU P. AGUSTIANANDA,
S.T., M.A

NAME

MUHAMAD ARIF SELGI PRABOWO

NIM

15512158

TITLE

SKEMA PENGELOLAHAN LIMBAH

SCALE

1:100

NO.

TOTAL

INFORMATION

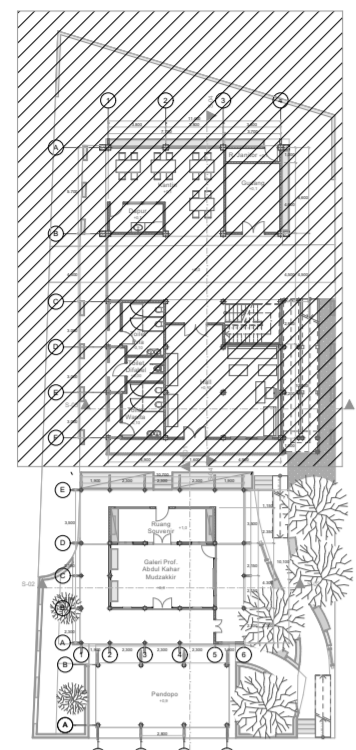

KEY PLAN

0. Ground Floor (13500)

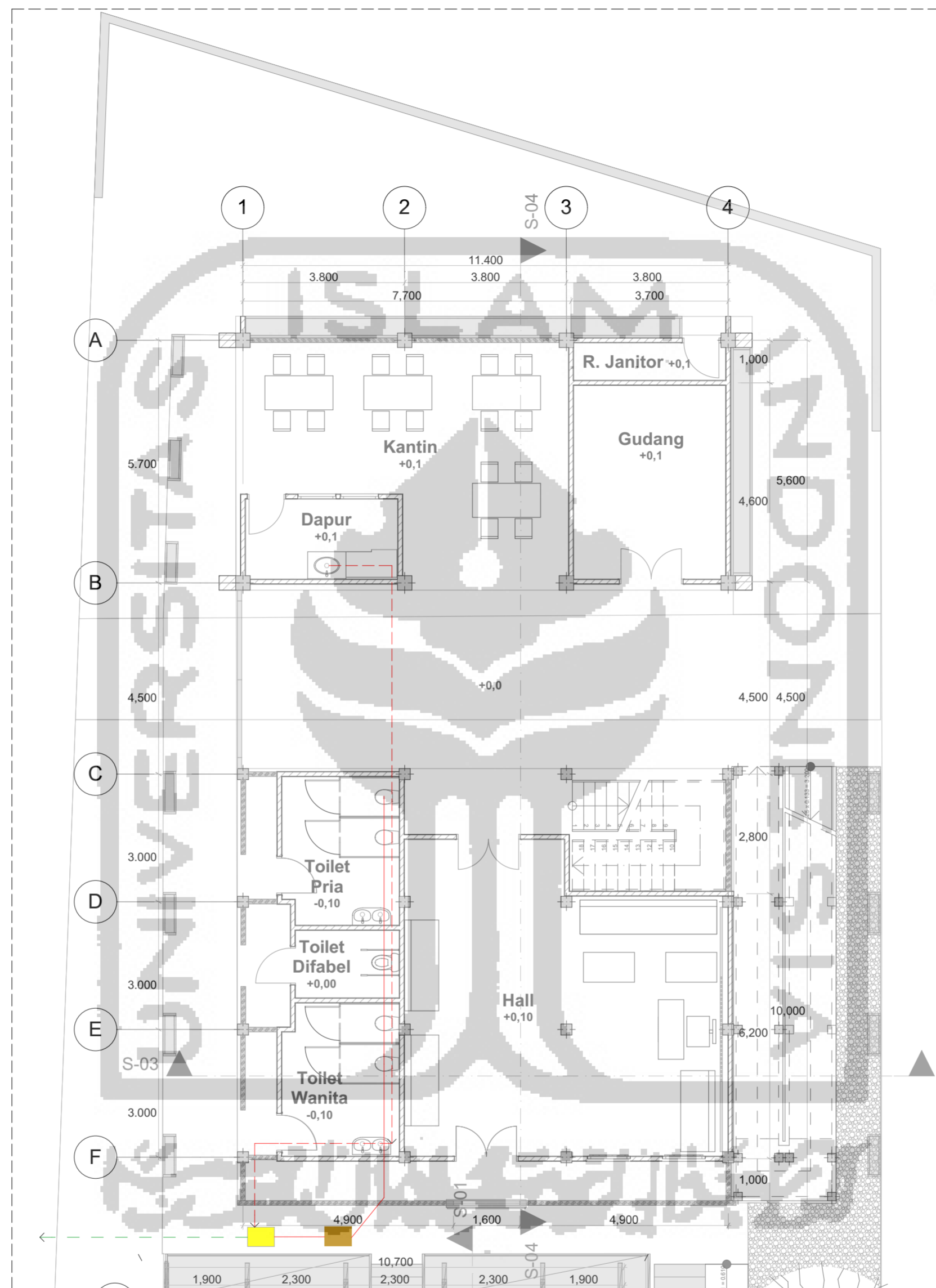
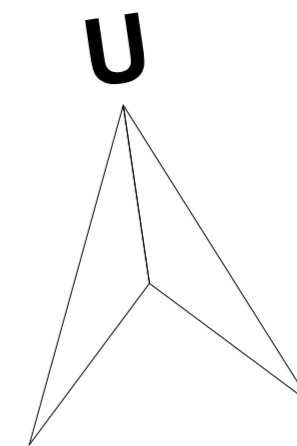







0. Ground Floor (2) 1:100



SKEMA PENGELOLAHAN LIMBAH
1:100

LEGENDA

-  FILTER AIR KOTOR
-  PIPA AIR KOTOR PADAT
-  PIPA AIR KOTOR CAIR
-  PIPA AIR MENUJU DRAINASE
-  SEPTIC TANK
-  SUMUR RESAPAN

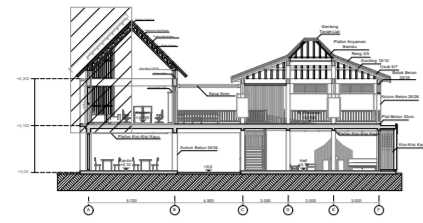

KEY PLAN

S-04 Building Section (7) 1:500

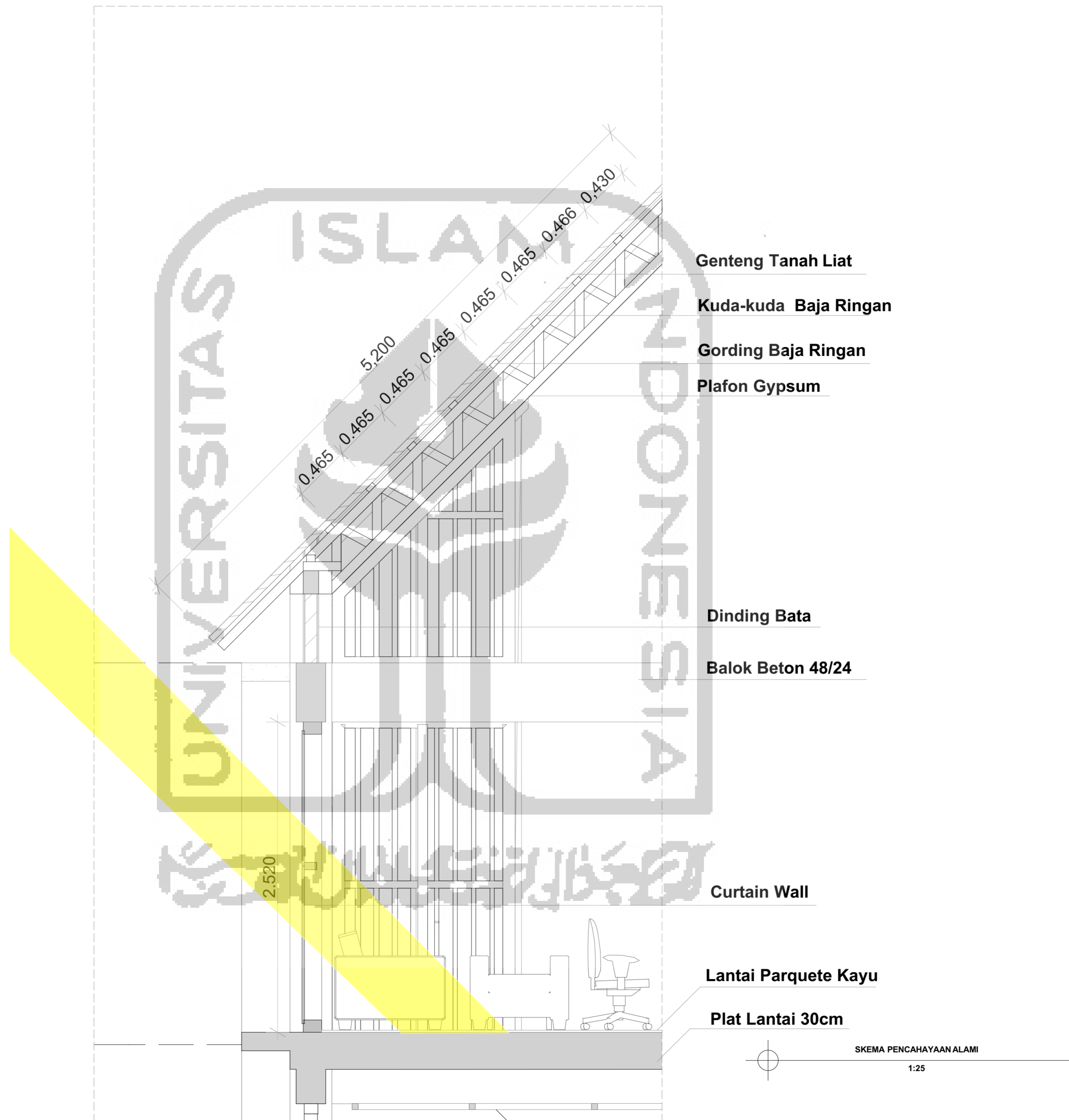

LEGENDA	
	CAHAYA MATAHARI



UNIVERSITAS ISLAM INDONESIA

BACHELOR FINAL PROJECT
DEPARTEMENT OF ARCHITECTURE
FACULTY OF CIVIL ENGINEERING
AND PLANNING

PROJECT

DESIGN OF KOTAGEDE CULTURAL
CENTER IN YOGYAKARTA WITH
ADAPTIVE REUSE AND ADDITION AS
CONSERVATION STRATEGIES

LECTURER

DR. ING- PUTU AYU P. AGUSTIANANDA,
S.T, M.A

NAME

MUHAMAD ARIF SELGI PRABOWO

NIM

15512158

TITLE

SKEMA PENCAHAYAAN ALAMI

SCALE

1:25

NO.

TOTAL

INFORMATION



BACHELOR FINAL PROJECT
 DEPARTEMENT OF ARCHITECTURE
 FACULTY OF CIVIL ENGINEERING
 AND
 PLANNING

PROJECT

DESIGN OF KOTAGEDE CULTURAL
 CENTER IN YOGYAKARTA WITH
 ADAPTIVE REUSE AND ADDITION AS
 CONSERVATION STRATEGIES

LECTURER

DR. ING- PUTU AYU P. AGUSTIANANDA,
 S.T., M.A

NAME

MUHAMAD ARIF SELGI PRABOWO

NIM

15512158

TITLE

SKEMA PENGHAWAAN

SCALE

1:50

NO.

TOTAL

INFORMATION

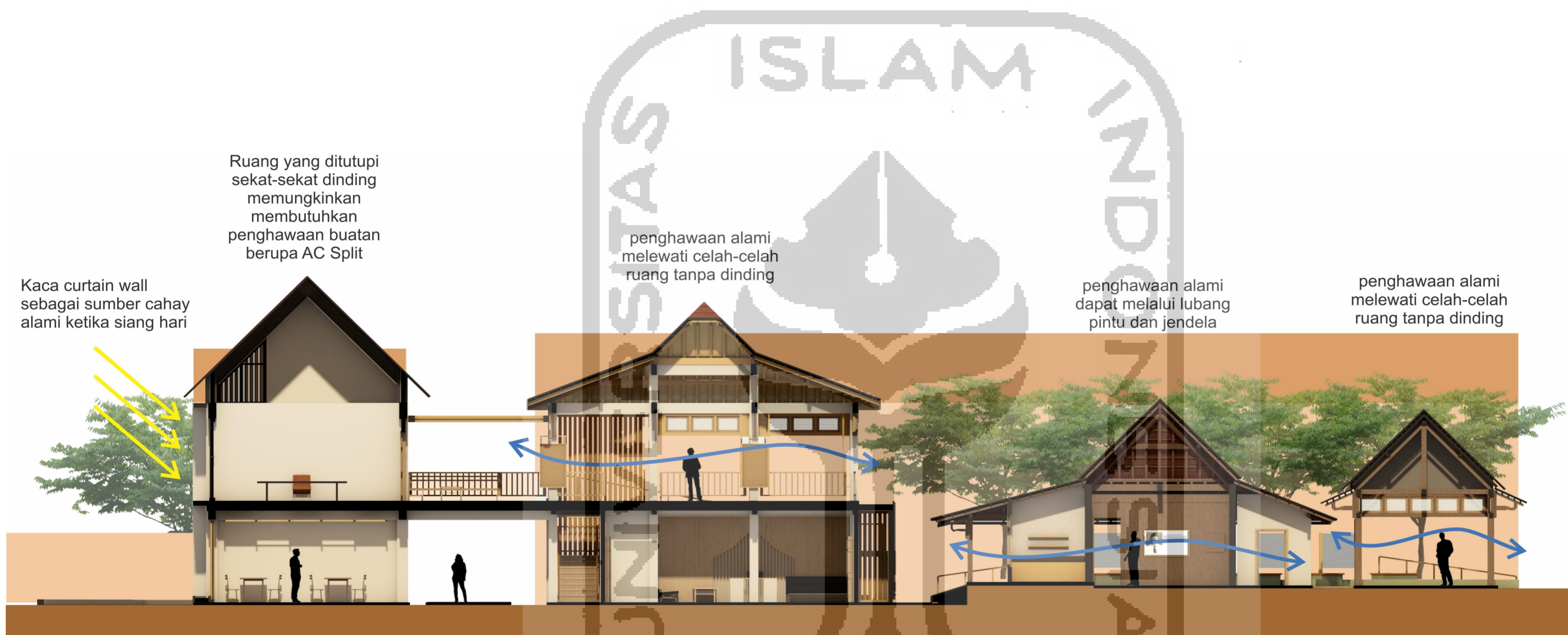

SKEMA PENGHAWAAN

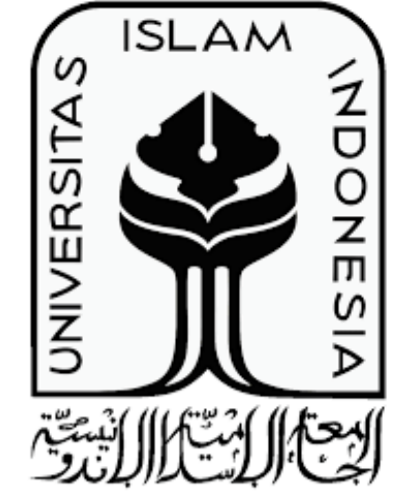

BACHELOR FINAL PROJECT
 DEPARTEMENT OF ARCHITECTURE
 FACULTY OF CIVIL ENGINEERING
 AND
 PLANNING

PROJECT

DESIGN OF KOTAGEDE CULTURAL
 CENTER IN YOGYAKARTA WITH
 ADAPTIVE REUSE AND ADDITION AS
 CONSERVATION STRATEGIES

LECTURER

DR. ING- PUTU AYU P. AGUSTIANANDA,
 S.T, M.A

NAME

MUHAMAD ARIF SELGI PRABOWO

NIM

15512158

TITLE

SKEMA PENGHAWAAN BUATAN

SCALE

1:100

NO.

TOTAL

INFORMATION

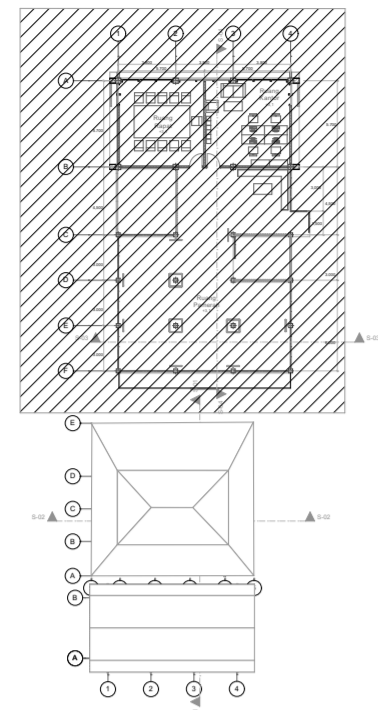

1. Story (1) 1:500

KEY PLAN

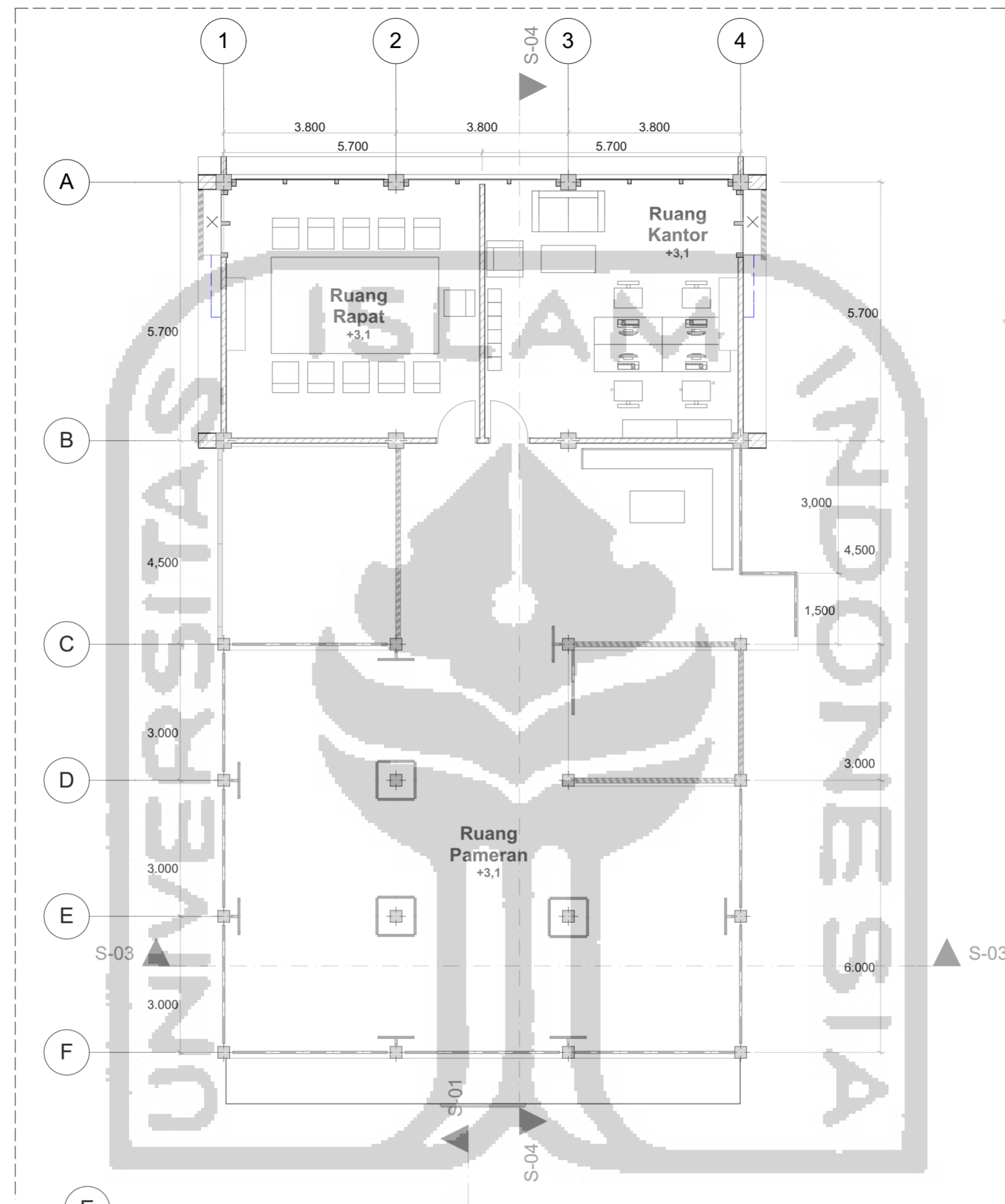

1. Story 1:100

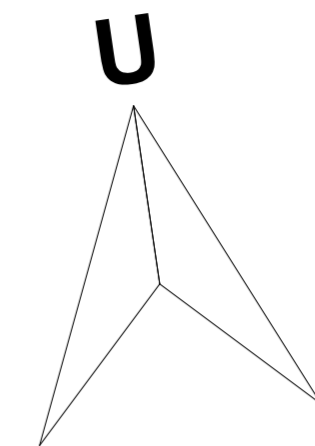

LEGENDA	
	AC INDOOR
	AC OUTDOOR
	PIPA AC



BACHELOR FINAL PROJECT
 DEPARTEMENT OF ARCHITECTURE
 FACULTY OF CIVIL ENGINEERING
 AND
 PLANNING

PROJECT

DESIGN OF KOTAGEDE CULTURAL
 CENTER IN YOGYAKARTA WITH
 ADAPTIVE REUSE AND ADDITION AS
 CONSERVATION STRATEGIES

LECTURER

DR. ING- PUTU AYU P. AGUSTIANANDA,
 S.T., M.A

NAME

MUHAMAD ARIF SELGI PRABOWO

NIM

15512158

TITLE

SI SKEMA PENCAHAYAAN ALAMI IL

SCALE

1:200

NO.

TOTAL

INFORMATION

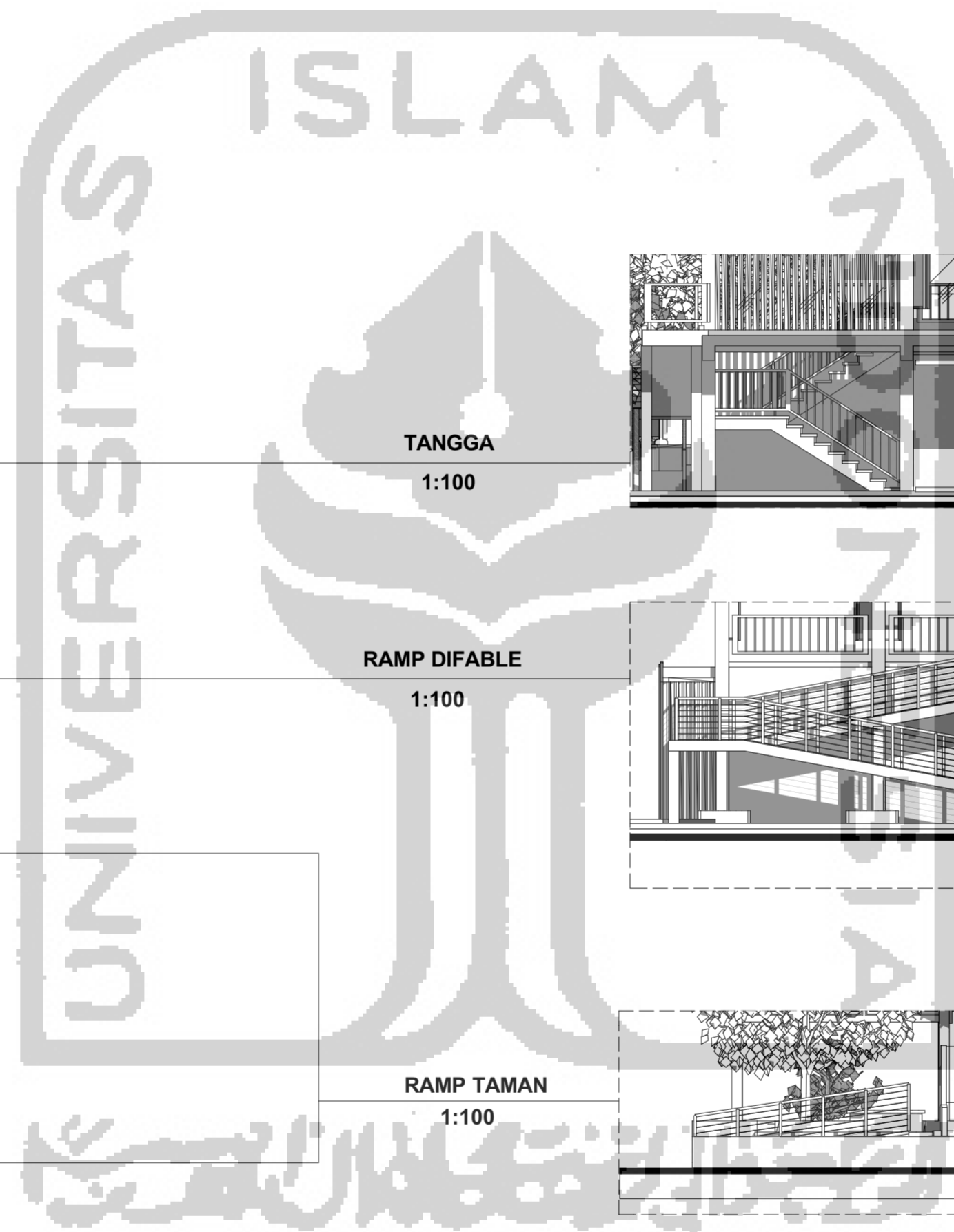
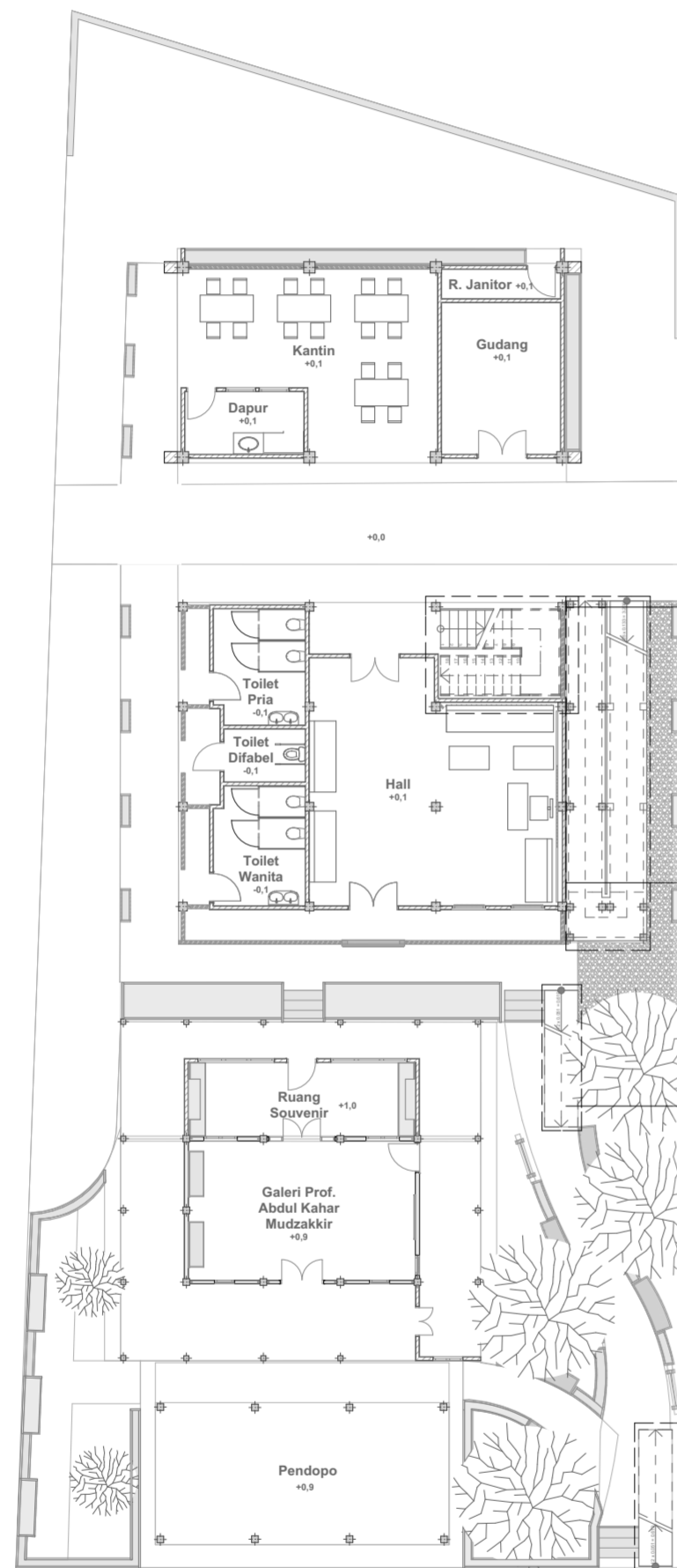
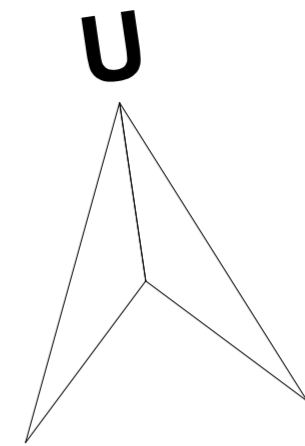

TANGGA
1:100

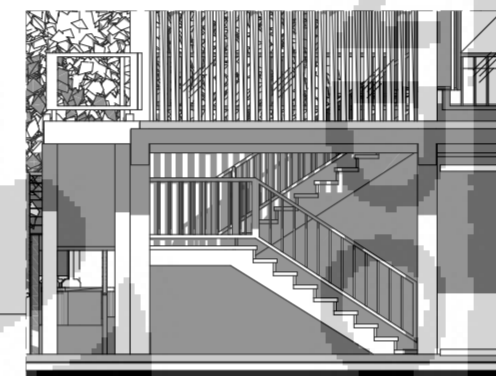

RAMP DIFABLE
1:100

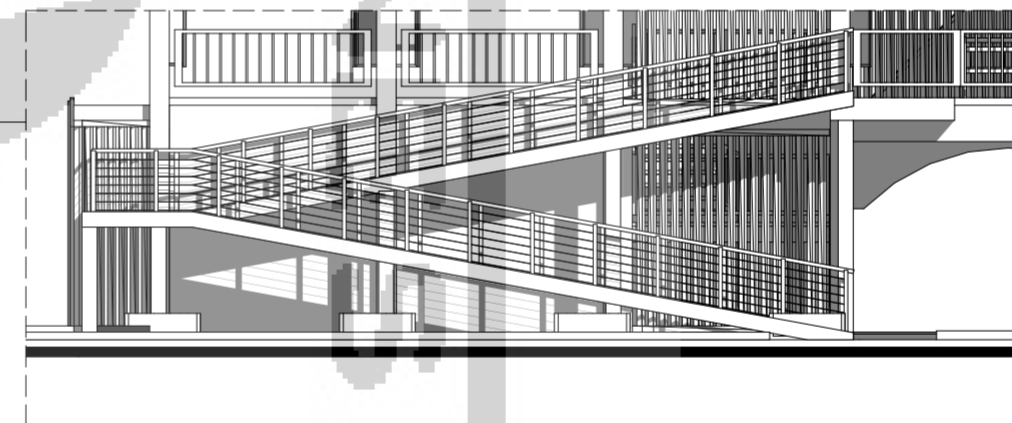

RAMP TAMAN
1:100

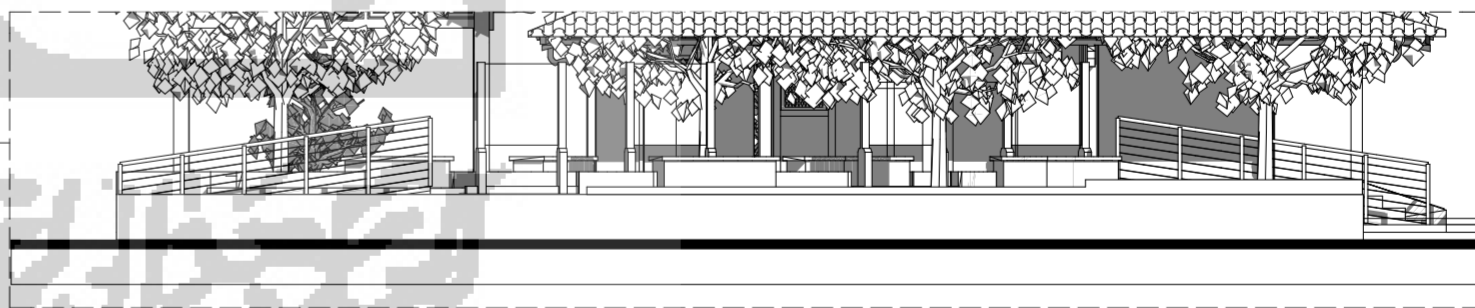

0. Ground Floor 1:200

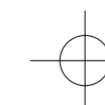

SKEMA PENCAHAYAAN ALAMI

1:100

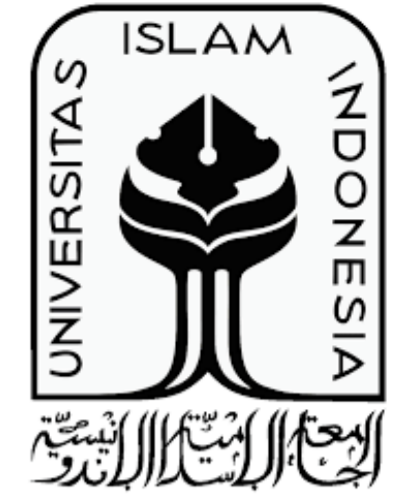

BACHELOR FINAL PROJECT
DEPARTMENT OF ARCHITECTURE
FACULTY OF CIVIL ENGINEERING
AND PLANNING

PROJECT

DESIGN OF KOTAGEDE CULTURAL CENTER IN YOGYAKARTA WITH ADAPTIVE REUSE AND ADDITION AS CONSERVATION STRATEGIES

LECTURER

DR. ING- PUTU AYU P. AGUSTIANANDA,
S.T, M.A

NAME

MUHAMAD ARIF SELGI PRABOWO

NIM

15512158

TITLE

SKEMA EVAKUASI KEBAKARAN

SCALE

1:200

NO.	TOTAL

INFORMATION

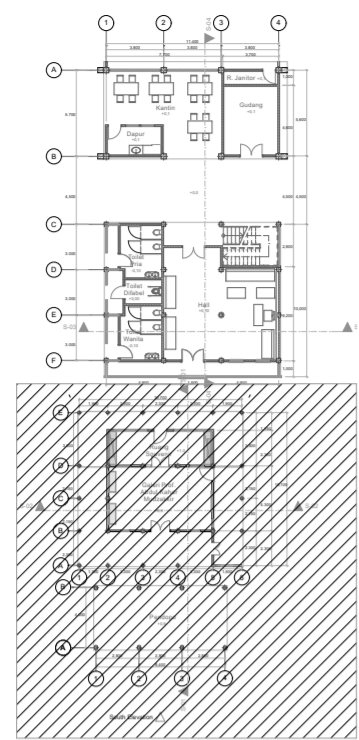
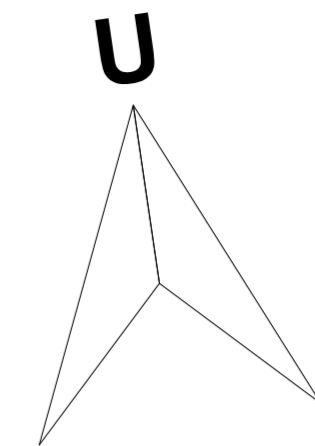

KEY PLAN

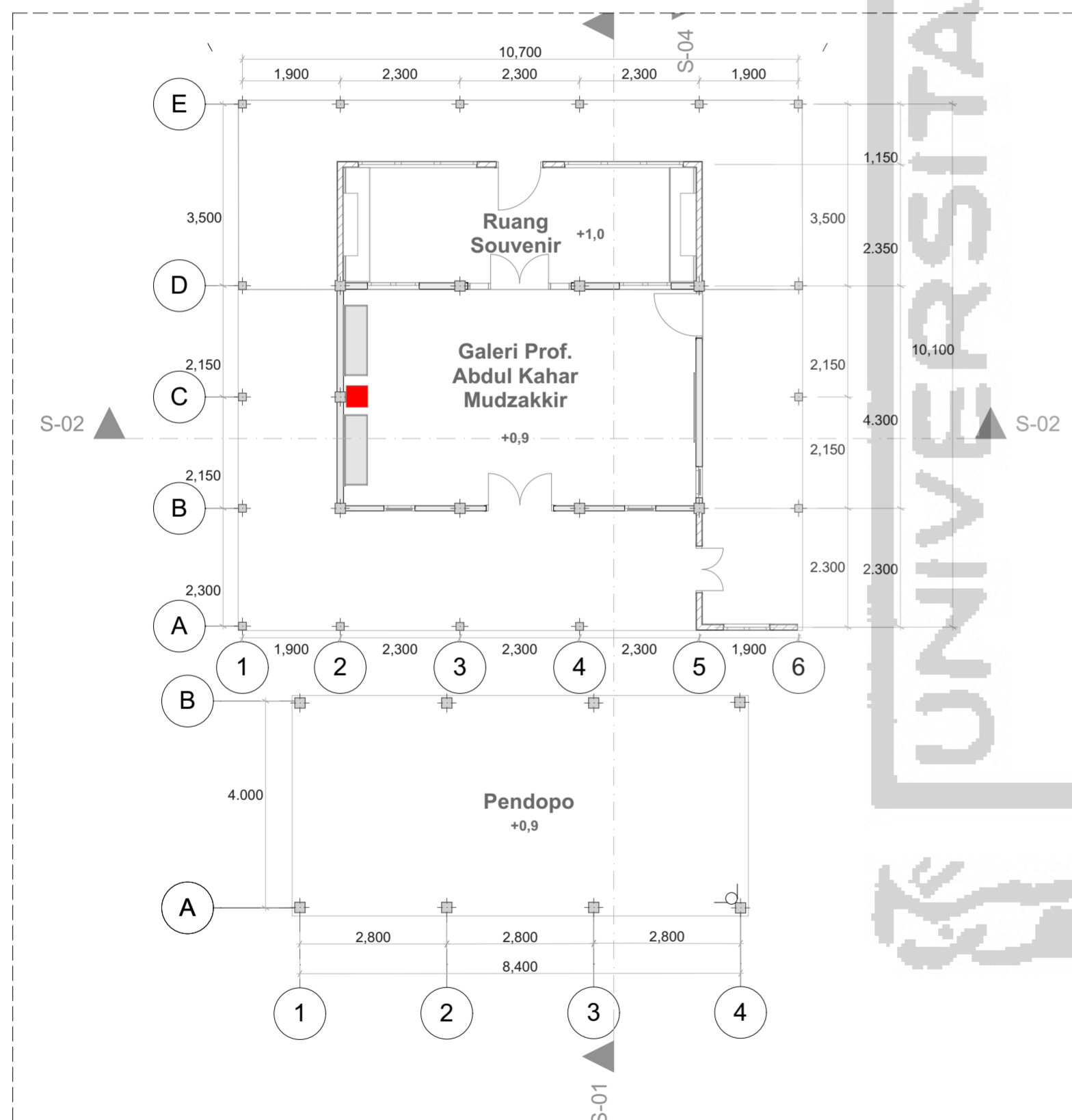

DENAH PARSIAL A

1:100

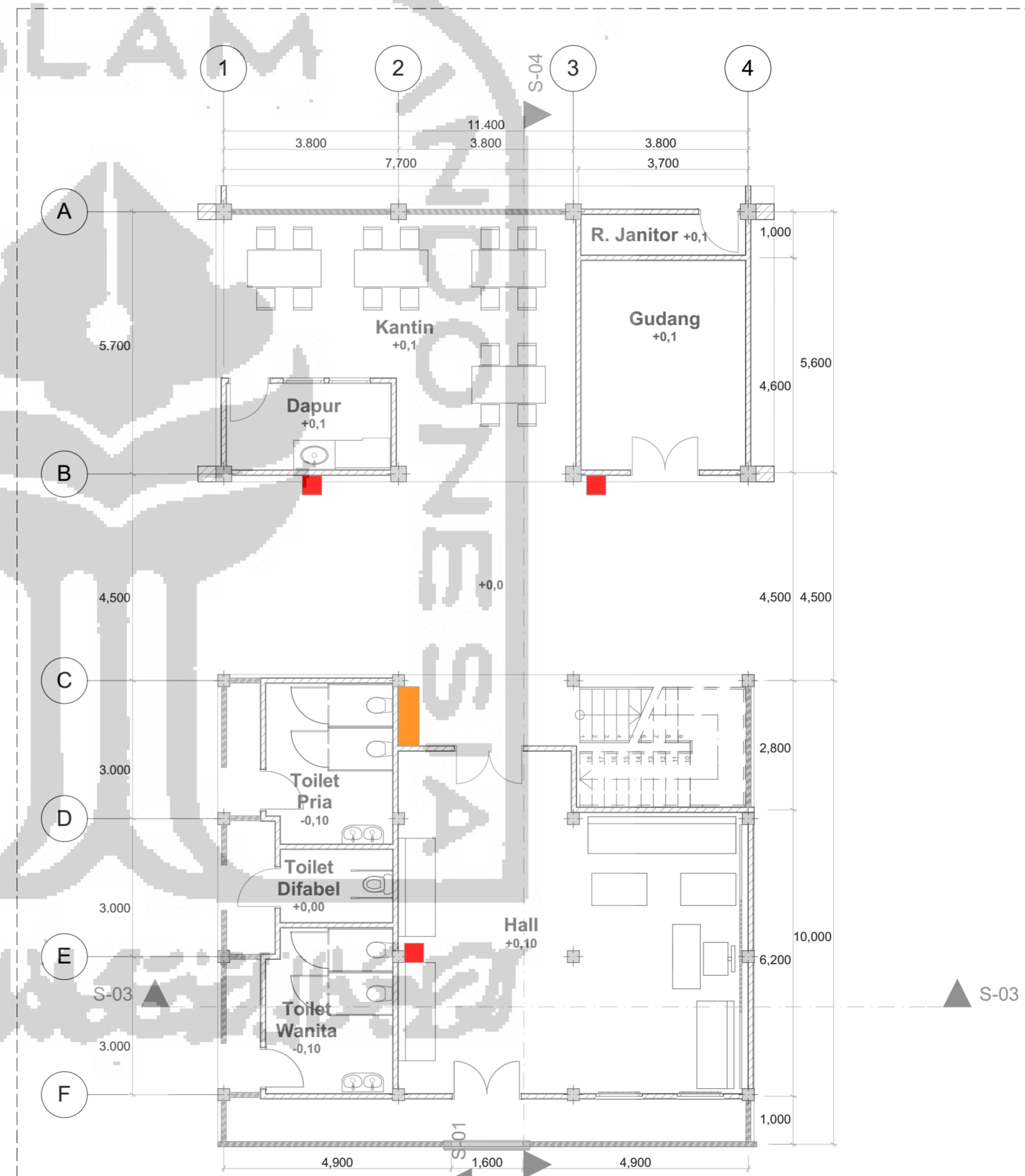

DENAH PARSIAL B

1:100

LEGENDA

- TABUNG APAR
- HYDRANT BOX



SKEMA EVAKUASI KEBAKARAN

1:100



BACHELOR FINAL PROJECT
 DEPARTEMENT OF ARCHITECTURE
 FACULTY OF CIVIL ENGINEERING
 AND
 PLANNING

PROJECT

DESIGN OF KOTAGEDE CULTURAL
 CENTER IN YOGYAKARTA WITH
 ADAPTIVE REUSE AND ADDITION AS
 CONSERVATION STRATEGIES

LECTURER

DR. ING- PUTU AYU P. AGUSTIANANDA,
 S.T, M.A

NAME

MUHAMAD ARIF SELGI PRABOWO

NIM

15512158

TITLE

SKEMA EVAKUASI KEBAKARAN 2

SCALE

1:200

NO.

TOTAL

INFORMATION

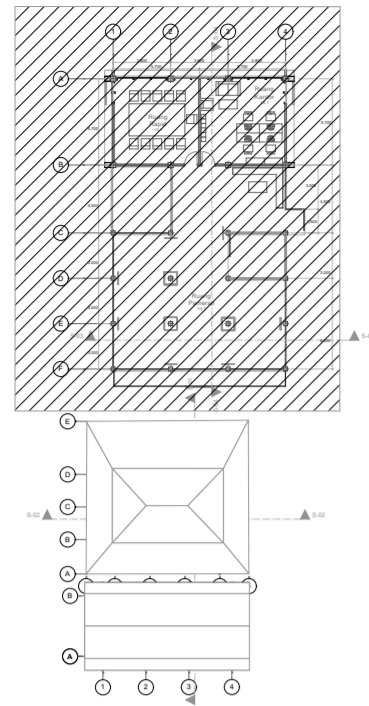
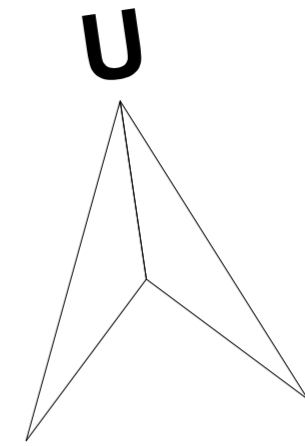

1. Story (1) 1:500

KEY PLAN

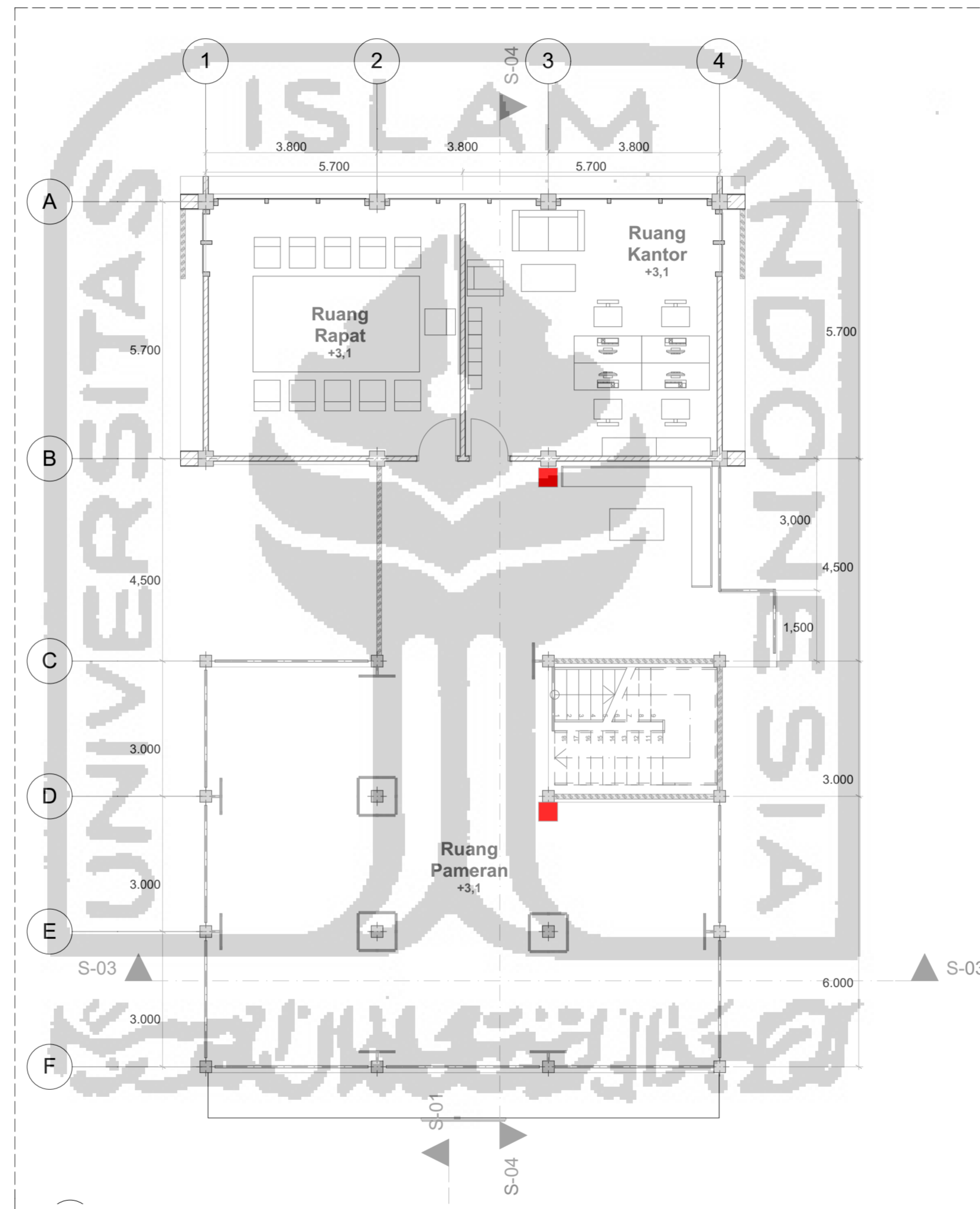

1.

Story (2)

1:100

LEGENDA

■ TABUNG APAR



SKEMA EVAKUASI KEBAKARAN 2
 1:100



BACHELOR FINAL PROJECT
 DEPARTEMENT OF ARCHITECTURE
 FACULTY OF CIVIL ENGINEERING
 AND
 PLANNING

PROJECT

DESIGN OF KOTAGEDE CULTURAL
 CENTER IN YOGYAKARTA WITH
 ADAPTIVE REUSE AND ADDITION AS
 CONSERVATION STRATEGIES

LECTURER

DR. ING- PUTU AYU P. AGUSTIANANDA,
 S.T., M.A

NAME

MUHAMAD ARIF SELGI PRABOWO

NIM

15512158

TITLE

SKEMA EVAKUASI KEBAKARAN 3

SCALE

1:200

NO.

TOTAL

INFORMATION

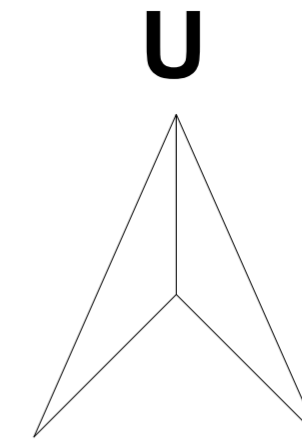

LEGENDA

 **TITIK KUMPUL**

 **JALAN WARGA**

 **JALUR EVAKUASI**

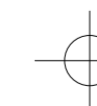

SKEMA EVAKUASI KEBAKARAN 3

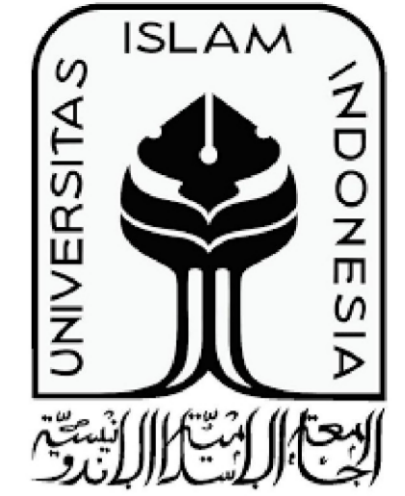

BACHELOR FINAL PROJECT
 DEPARTEMENT OF ARCHITECTURE
 FACULTY OF CIVIL ENGINEERING
 AND
 PLANNING

PROJECT

DESIGN OF KOTAGEDE CULTURAL
 CENTER IN YOGYAKARTA WITH
 ADAPTIVE REUSE AND ADDITION AS
 CONSERVATION STRATEGIES

LECTURER

DR. ING- PUTU AYU P. AGUSTIANANDA,
 S.T, M.A

NAME

MUHAMAD ARIF SELGI PRABOWO

NIM

15512158

TITLE

SKEMA BARRIER FREE DESIGN

SCALE

1:100

NO.	TOTAL

INFORMATION

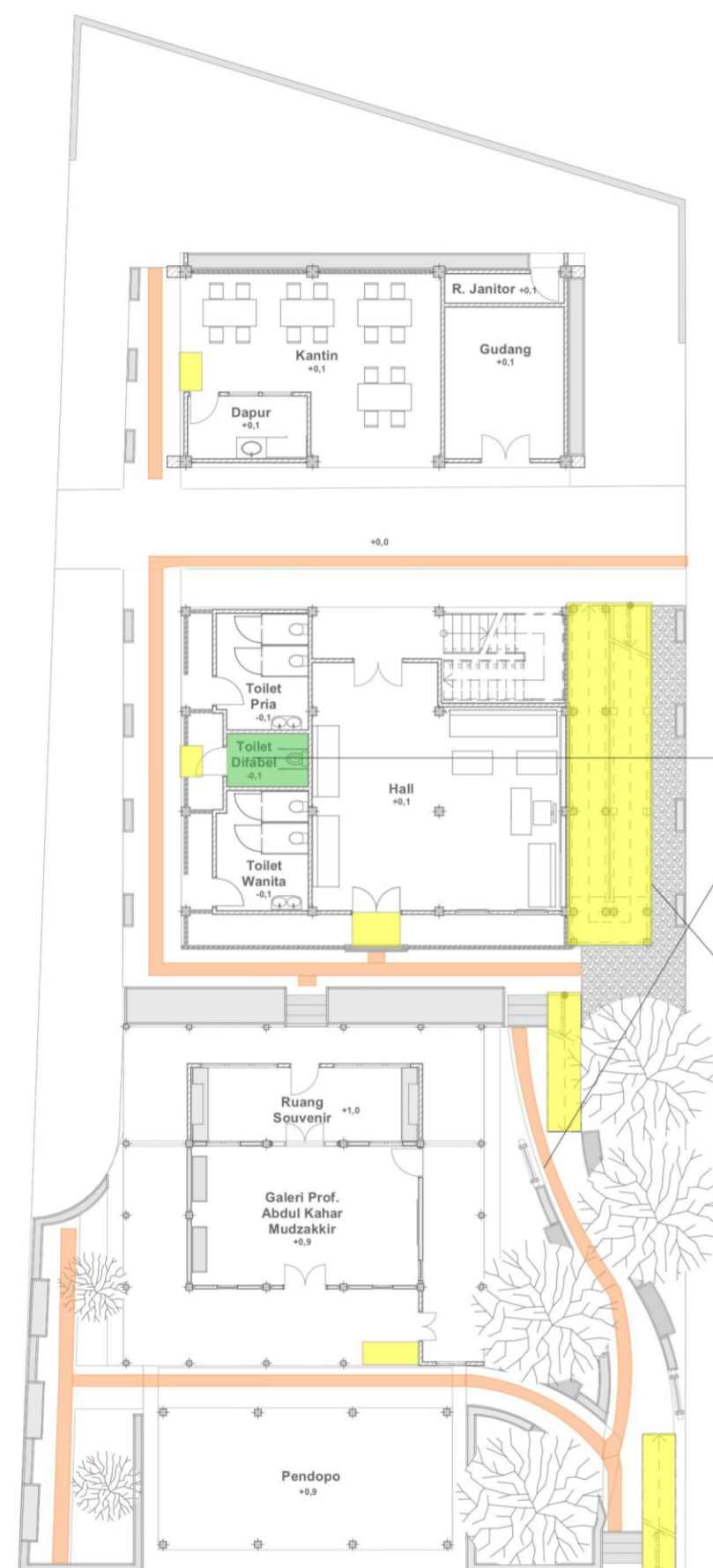
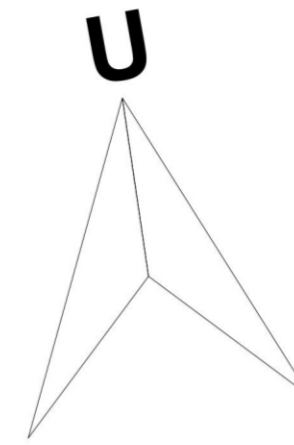

0. Ground Floor 1:200

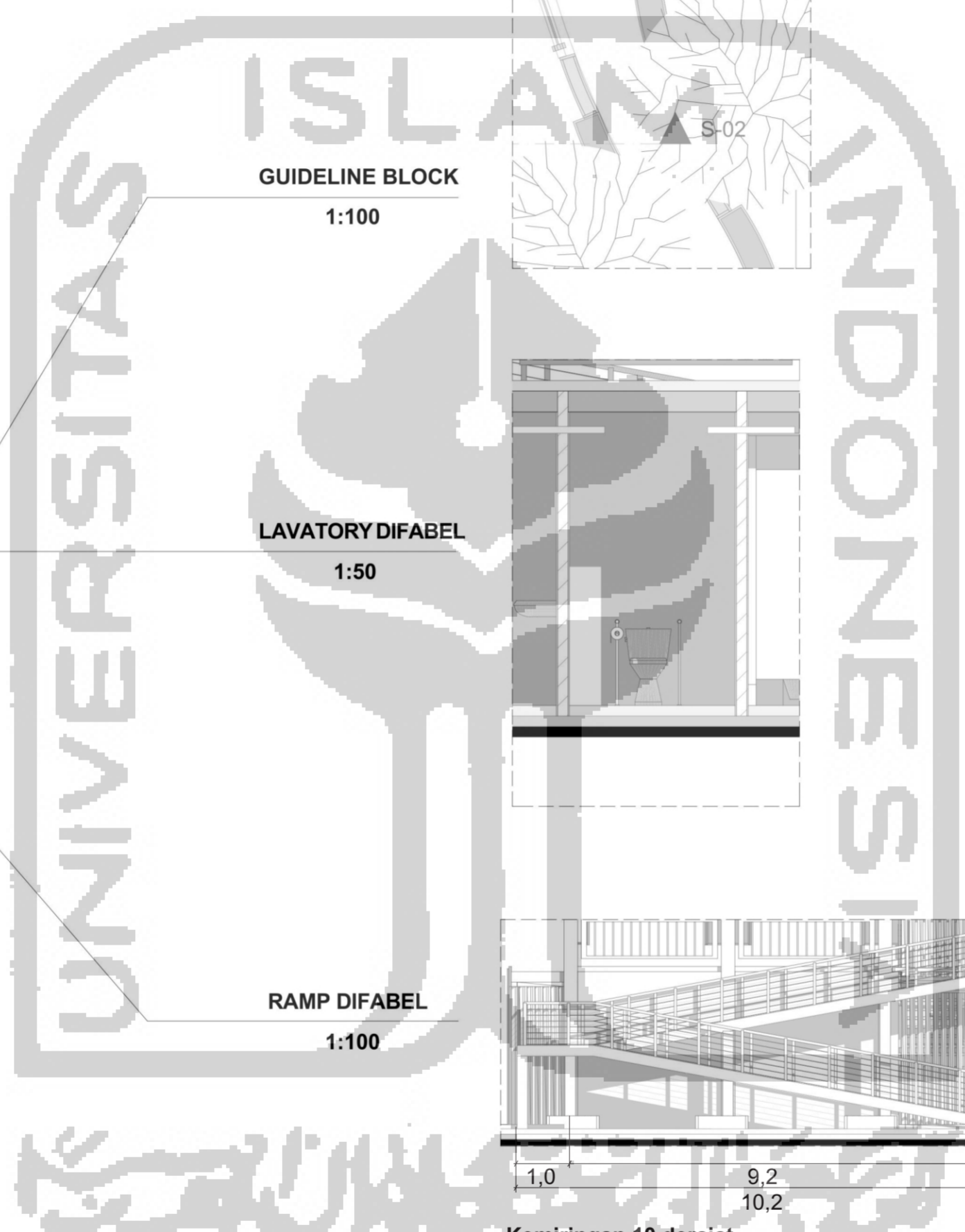

GUIDELINE BLOCK
1:100

LAVATORY DIFABEL
1:50

RAMP DIFABEL
1:100

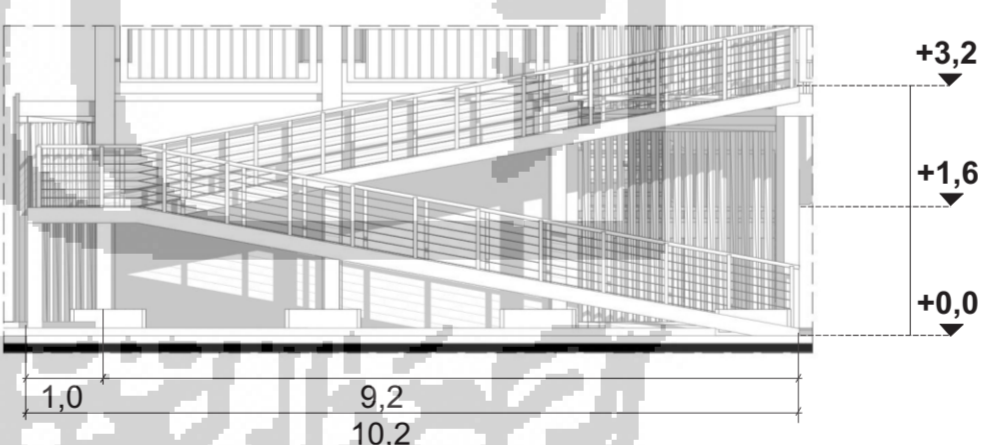
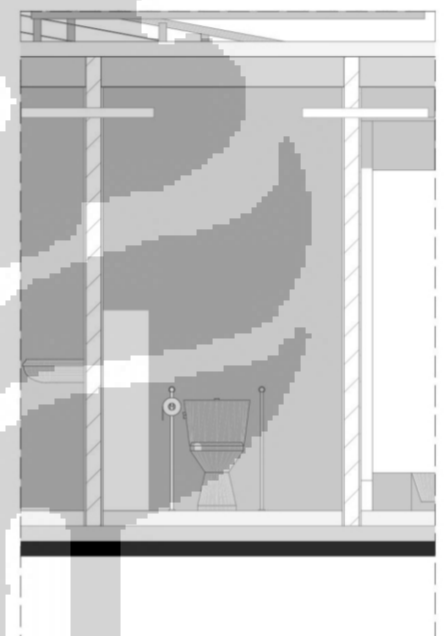
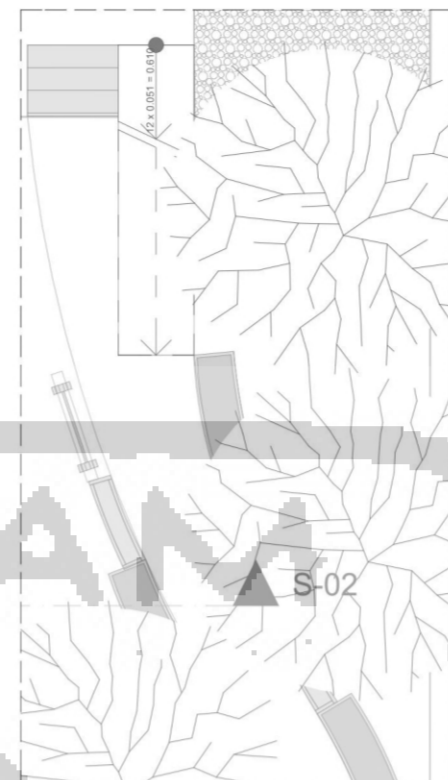

LEGENDA

	RAMP DIFABEL
	GUIDELINE BLOCK
	LAVATORY DIFABEL



BACHELOR FINAL PROJECT
DEPARTEMENT OF ARCHITECTURE
FACULTY OF CIVIL ENGINEERING
AND PLANNING

PROJECT

DESIGN OF KOTAGEDE CULTURAL CENTER IN YOGYAKARTA WITH ADAPTIVE REUSE AND ADDITION AS CONSERVATION STRATEGIES

LECTURER

DR. ING- PUTU AYU P. AGUSTIANANDA,
S.T, M.A

NAME

MUHAMAD ARIF SELGI PRABOWO

NIM

15512158

TITLE

SKEMA PENYEDIAAN ENERGI

SCALE

1:200

NO.	TOTAL

INFORMATION

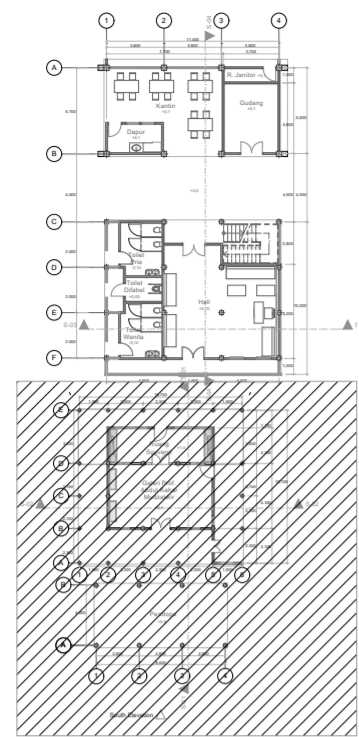
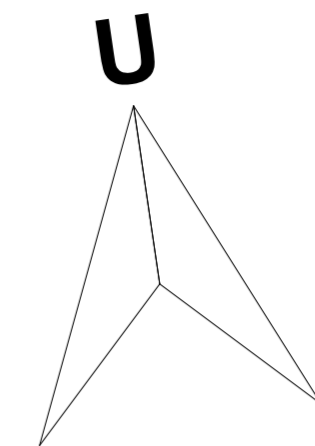

KEY PLAN

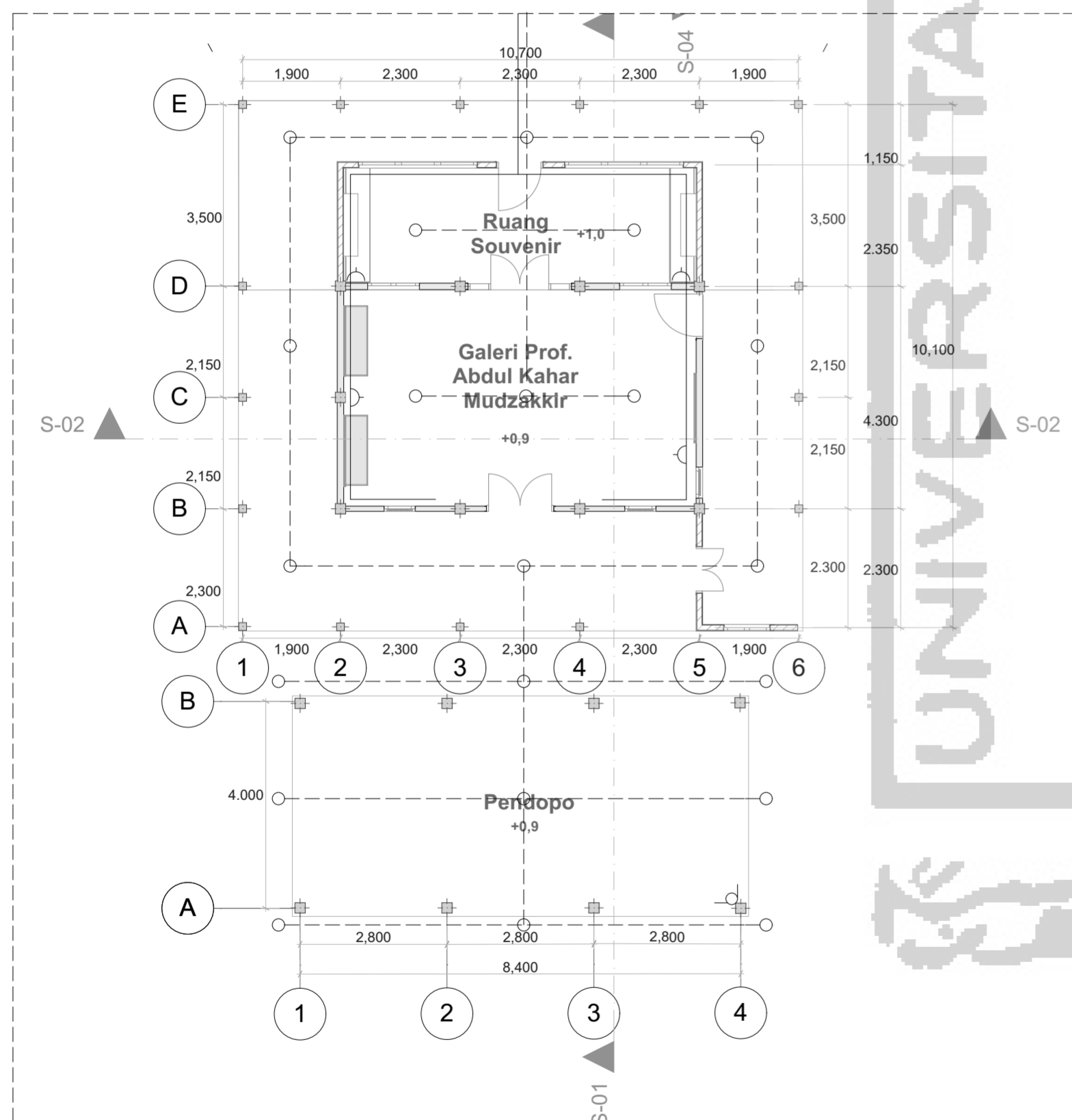

DENAH PARSIAL A

1:100

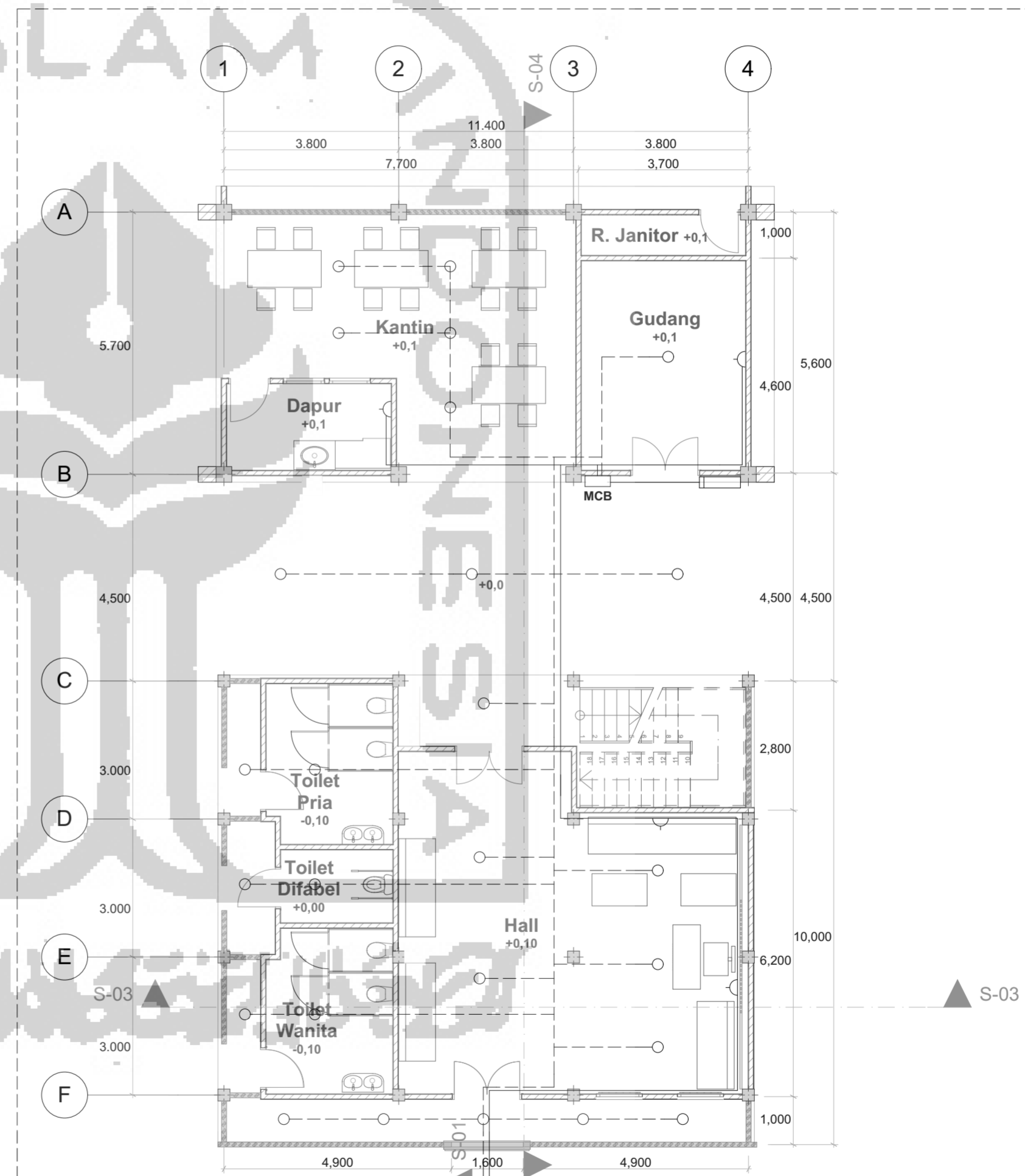

DENAH PARSIAL B

1:100

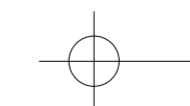

SKEMA EVAKUASI KEBAKARAN

1:100

LEGENDA

-  APP PLN
-  MCB
-  KABEL STOP KONTAK
-  KABEL TITIK LAMPU
-  TITIK LAMPU
-  STOP KONTAK DINDING

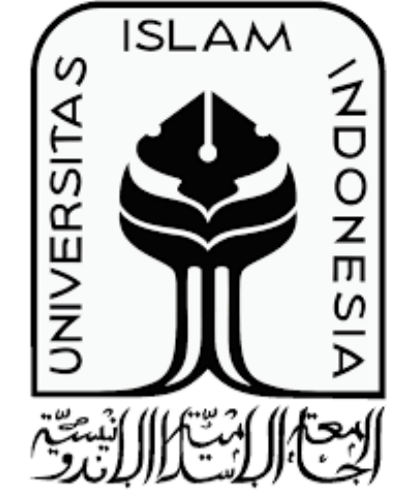

BACHELOR FINAL PROJECT
 DEPARTEMENT OF ARCHITECTURE
 FACULTY OF CIVIL ENGINEERING
 AND
 PLANNING

PROJECT

DESIGN OF KOTAGEDE CULTURAL
 CENTER IN YOGYAKARTA WITH
 ADAPTIVE REUSE AND ADDITION AS
 CONSERVATION STRATEGIES

LECTURER

DR. ING- PUTU AYU P. AGUSTIANANDA,
 S.T, M.A

NAME

MUHAMAD ARIF SELGI PRABOWO

NIM

15512158

TITLE

SKEMA PENYEDIAAN ENERGI 2

SCALE

1:200

NO.	TOTAL

INFORMATION

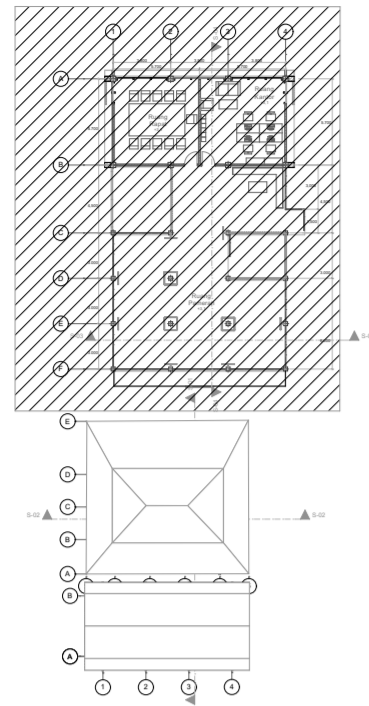

1. Story (1) 1:500

KEY PLAN

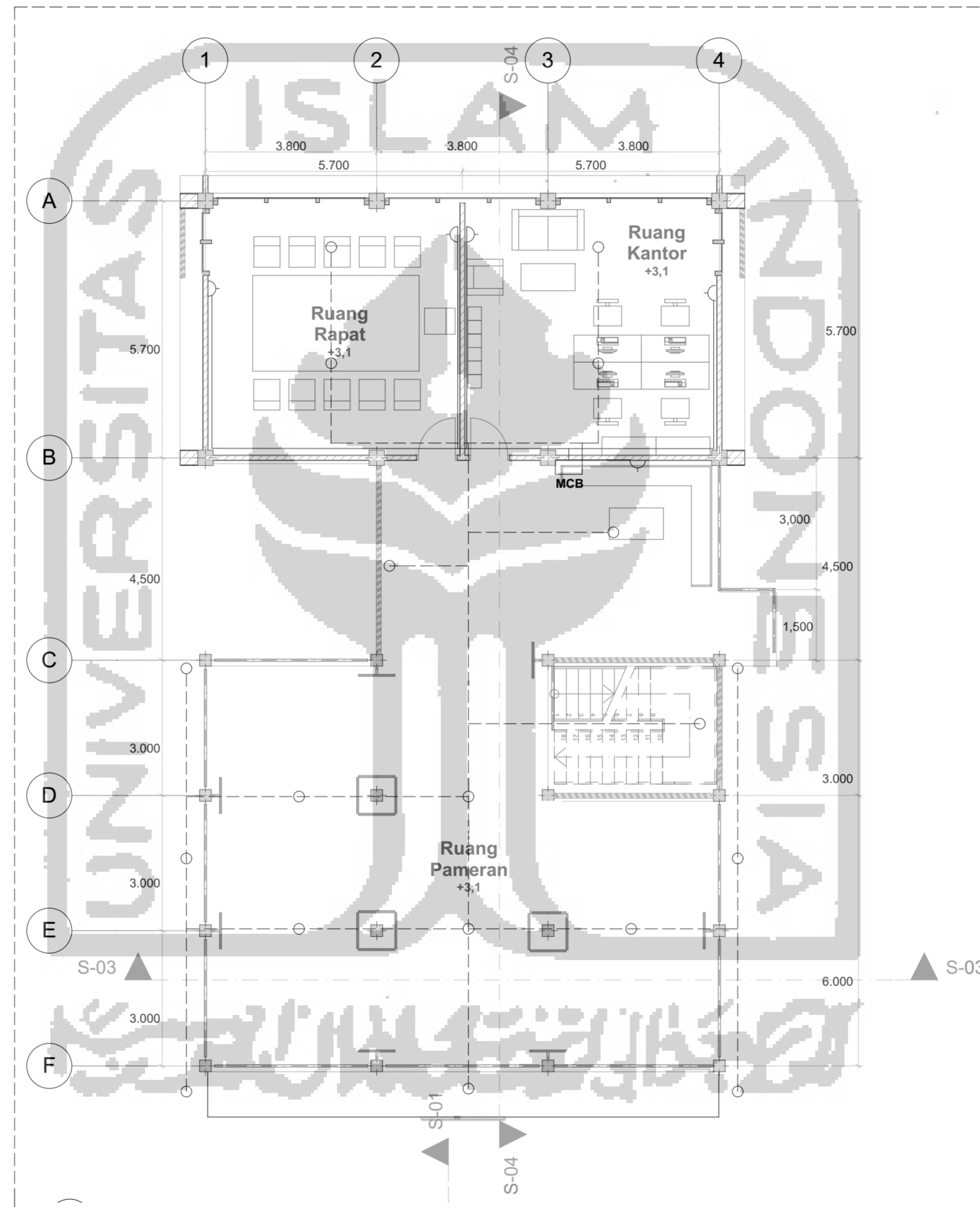

1.

Story (2)

1:100

LEGENDA	
	MCB
	KABEL STOP KONTAK
	KABEL TITIK LAMPU
	TITIK LAMPU
	STOP KONTAK DINDING

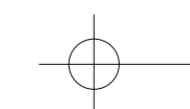

SKEMA PENYEDIAAN ENERGI 2
 1:100

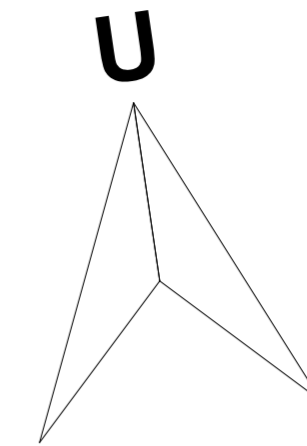



BACHELOR FINAL PROJECT
 DEPARTEMENT OF ARCHITECTURE
 FACULTY OF CIVIL ENGINEERING
 AND
 PLANNING

PROJECT

DESIGN OF KOTAGEDE CULTURAL
 CENTER IN YOGYAKARTA WITH
 ADAPTIVE REUSE AND ADDITION AS
 CONSERVATION STRATEGIES

LECTURER

DR. ING- PUTU AYU P. AGUSTIANANDA,
 S.T, M.A

NAME

MUHAMAD ARIF SELGI PRABOWO

NIM

15512158

TITLE

SKEMA PENYEDIAAN ENERGI

SCALE

1:200

NO.

TOTAL

INFORMATION

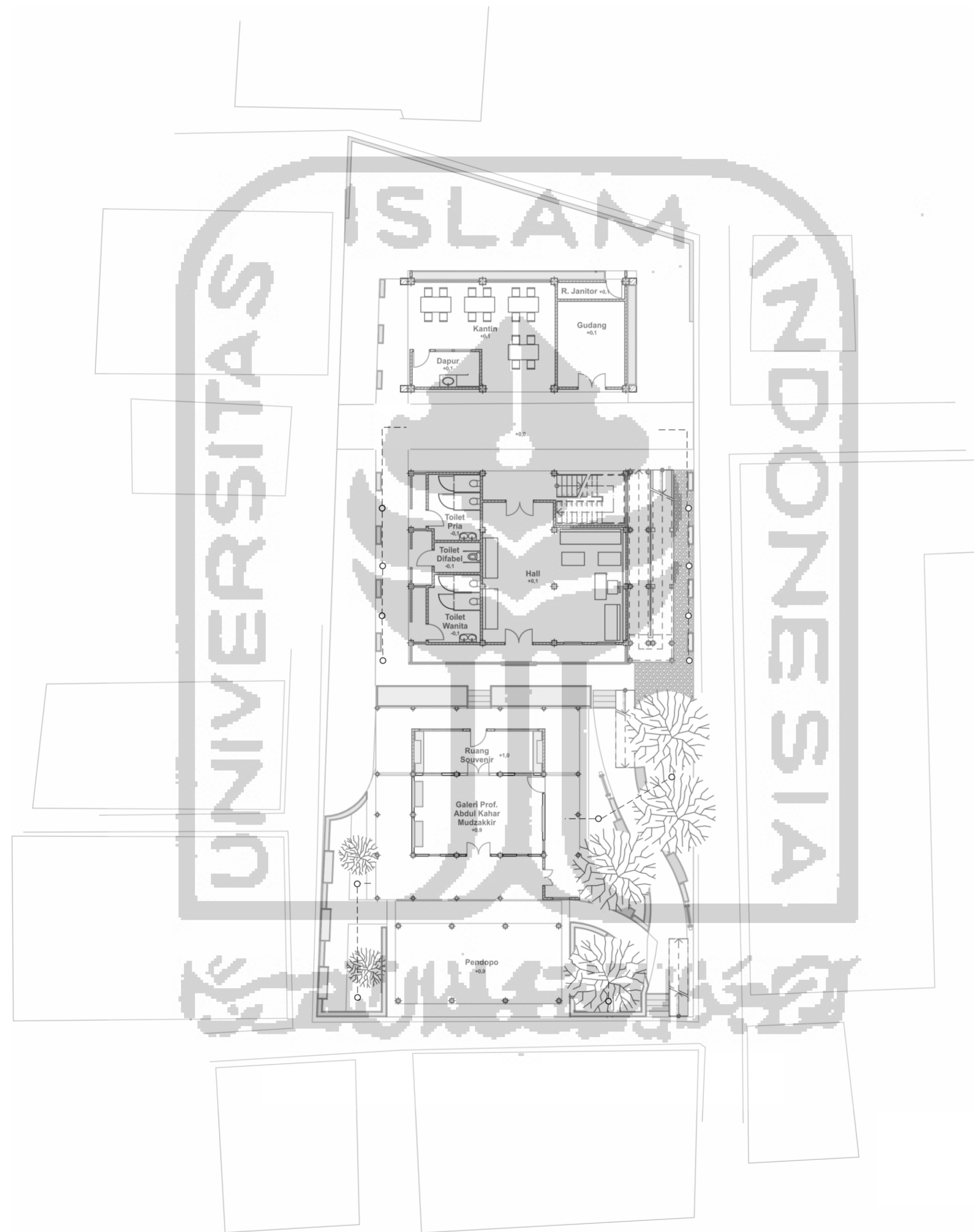

LEGENDA

- KABEL TITIK LAMPU
- TITIK LAMPU

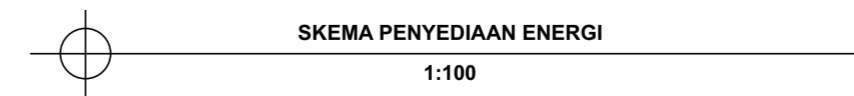



BACHELOR FINAL PROJECT
 DEPARTEMENT OF ARCHITECTURE
 FACULTY OF CIVIL ENGINEERING
 AND
 PLANNING

PROJECT

DESIGN OF KOTAGEDE CULTURAL
 CENTER IN YOGYAKARTA WITH
 ADAPTIVE REUSE AND ADDITION AS
 CONSERVATION STRATEGIES

LECTURER

DR. ING- PUTU AYU P. AGUSTIANANDA,
 S.T, M.A

NAME

MUHAMAD ARIF SELGI PRABOWO

NIM

15512158

TITLE

DETAIL INTERIOR BANGUNAN

SCALE

NO.	TOTAL

INFORMATION

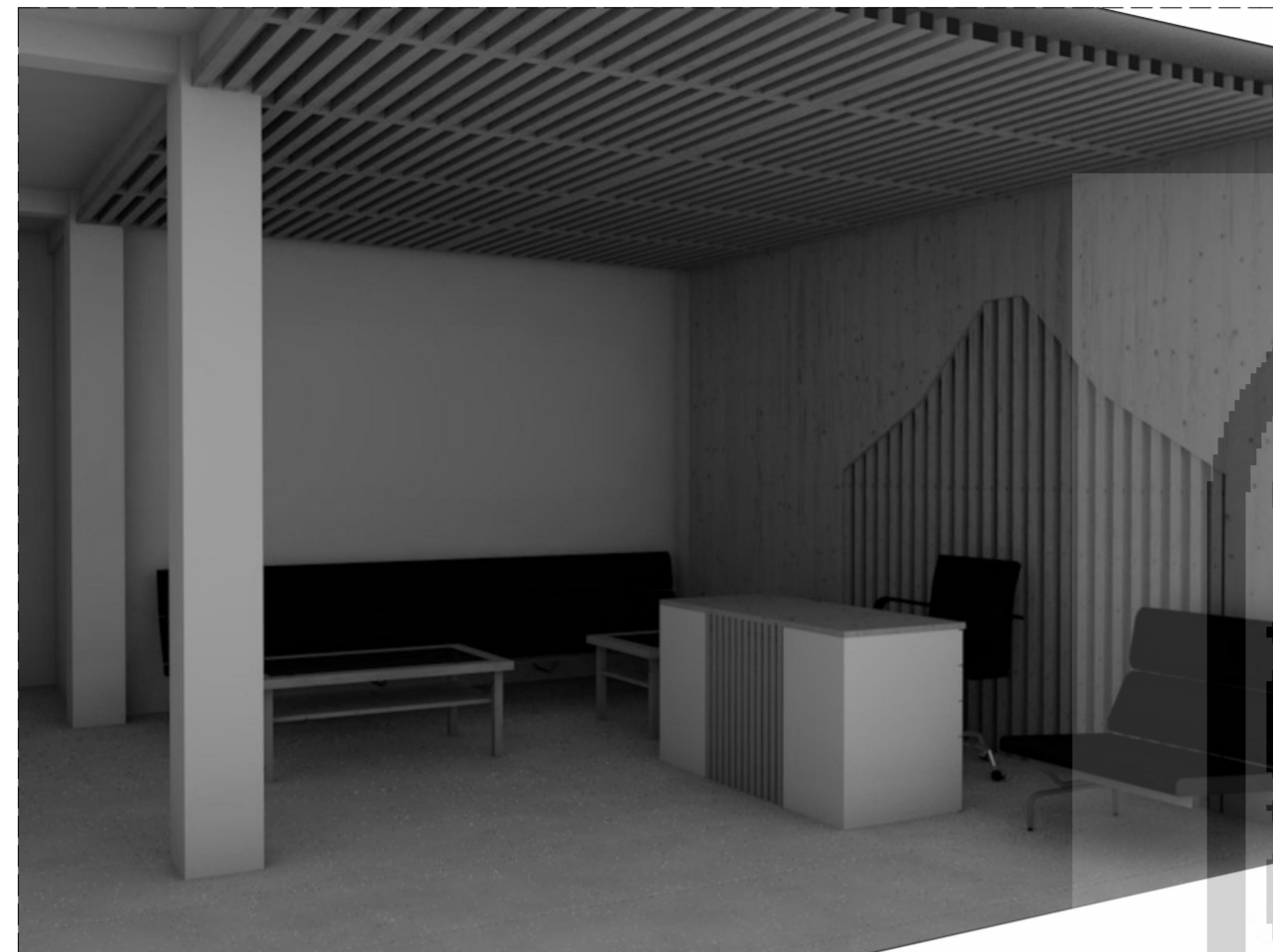

POTONGAN AXONOMETRI

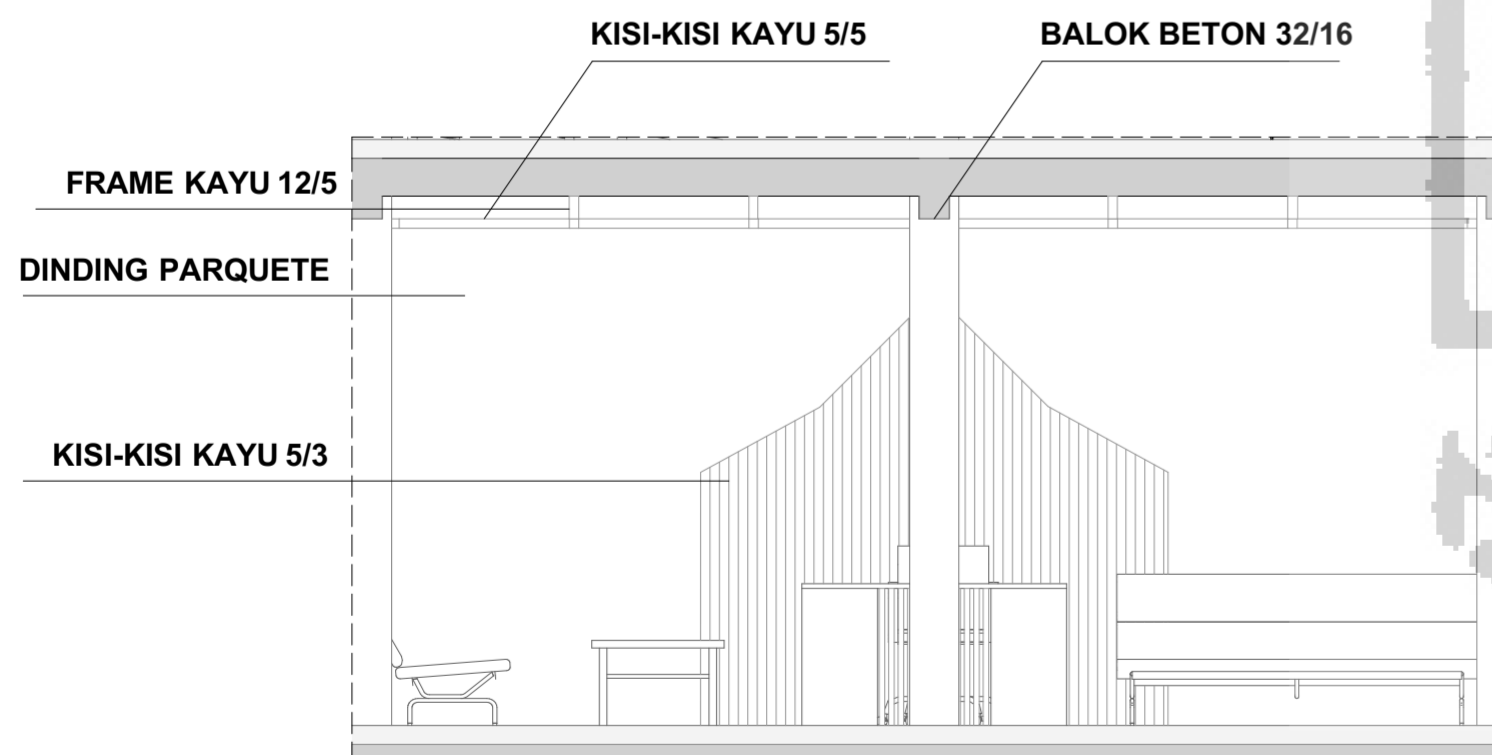

TAMPAK BARAT INTERIOR HALL

1:40

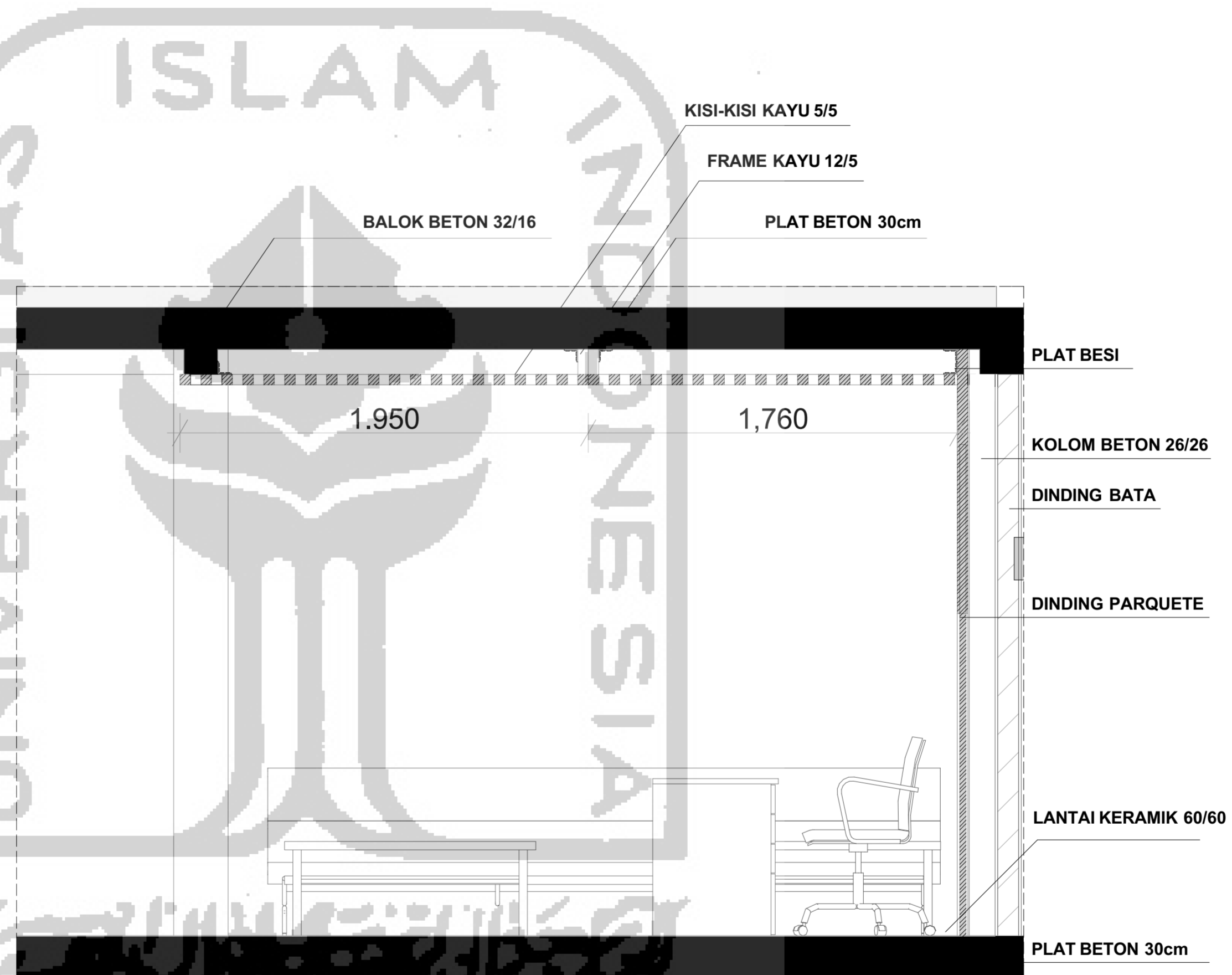

POTONGAN INTERIOR HALL

1:25



DETAIL INTERIOR BANGUNAN

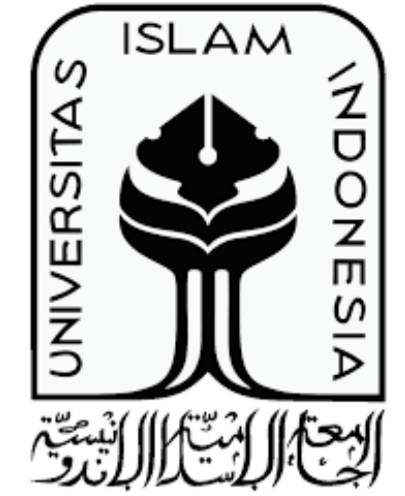

BACHELOR FINAL PROJECT
 DEPARTEMENT OF ARCHITECTURE
 FACULTY OF CIVIL ENGINEERING
 AND PLANNING

PROJECT

DESIGN OF KOTAGEDE CULTURAL
 CENTER IN YOGYAKARTA WITH
 ADAPTIVE REUSE AND ADDITION AS
 CONSERVATION STRATEGIES

LECTURER

DR. ING- PUTU AYU P. AGUSTIANANDA,
 S.T, M.A

NAME

MUHAMAD ARIF SELGI PRABOWO

NIM

15512158

TITLE

DETAIL SELUBUNG BANGUNAN

SCALE

NO.	TOTAL

INFORMATION



POTONGAN AXONOMETRI

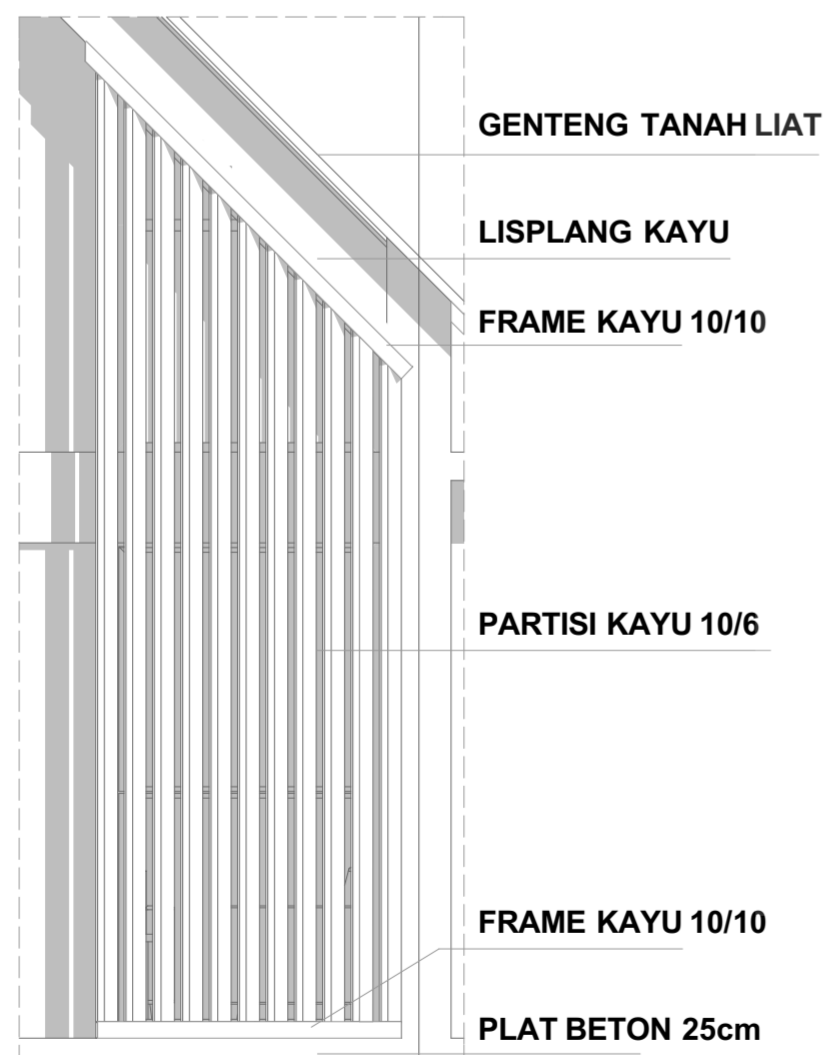

TAMPAK SELUBUNG BANGUNAN

1:40

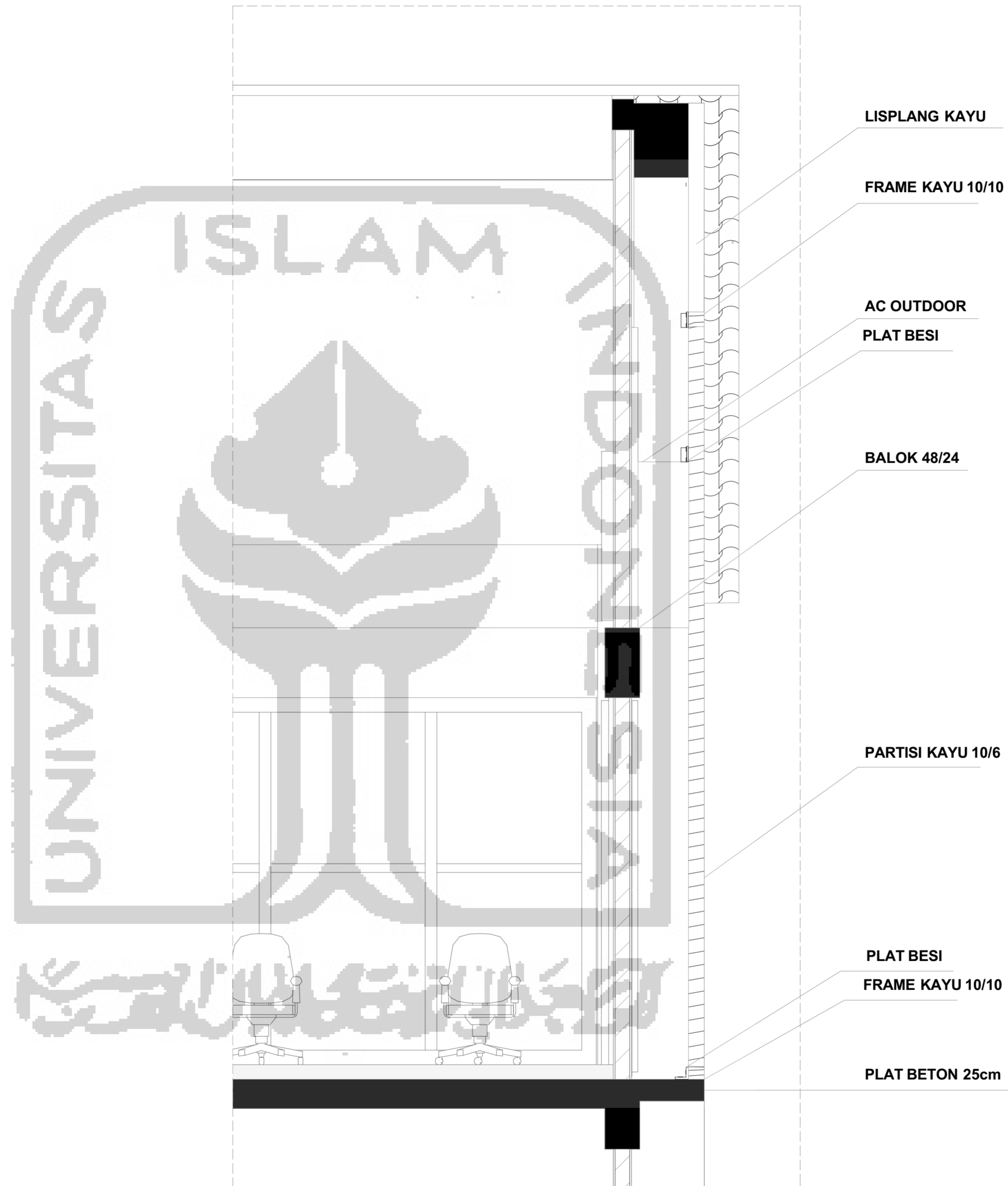

POTONGAN SELUBUNG BANGUNAN

1:25



LISPLANG KAYU

FRAME KAYU 10/10

AC OUTDOOR

PLAT BESI

BALOK 48/24

PARTISI KAYU 10/6

PLAT BESI

FRAME KAYU 10/10

PLAT BETON 25cm



الجامعة الإسلامية
INDONESIA

BACHELOR FINAL PROJECT
DEPARTEMENT OF ARCHITECTURE
FACULTY OF CIVIL ENGINEERING
AND
PLANNING

PROJECT

DESIGN OF KOTAGEDE CULTURAL
CENTER IN YOGYAKARTA WITH
ADAPTIVE REUSE AND ADDITION AS
CONSERVATION STRATEGIES

LECTURER

DR. ING- PUTU AYU P. AGUSTIANANDA,
S.T, M.A

NAME

MUHAMAD ARIF SELGI PRABOWO

NIM

15512158

TITLE

DETAIL ARSITEKTURAL 1

SCALE

NO.	TOTAL

INFORMATION

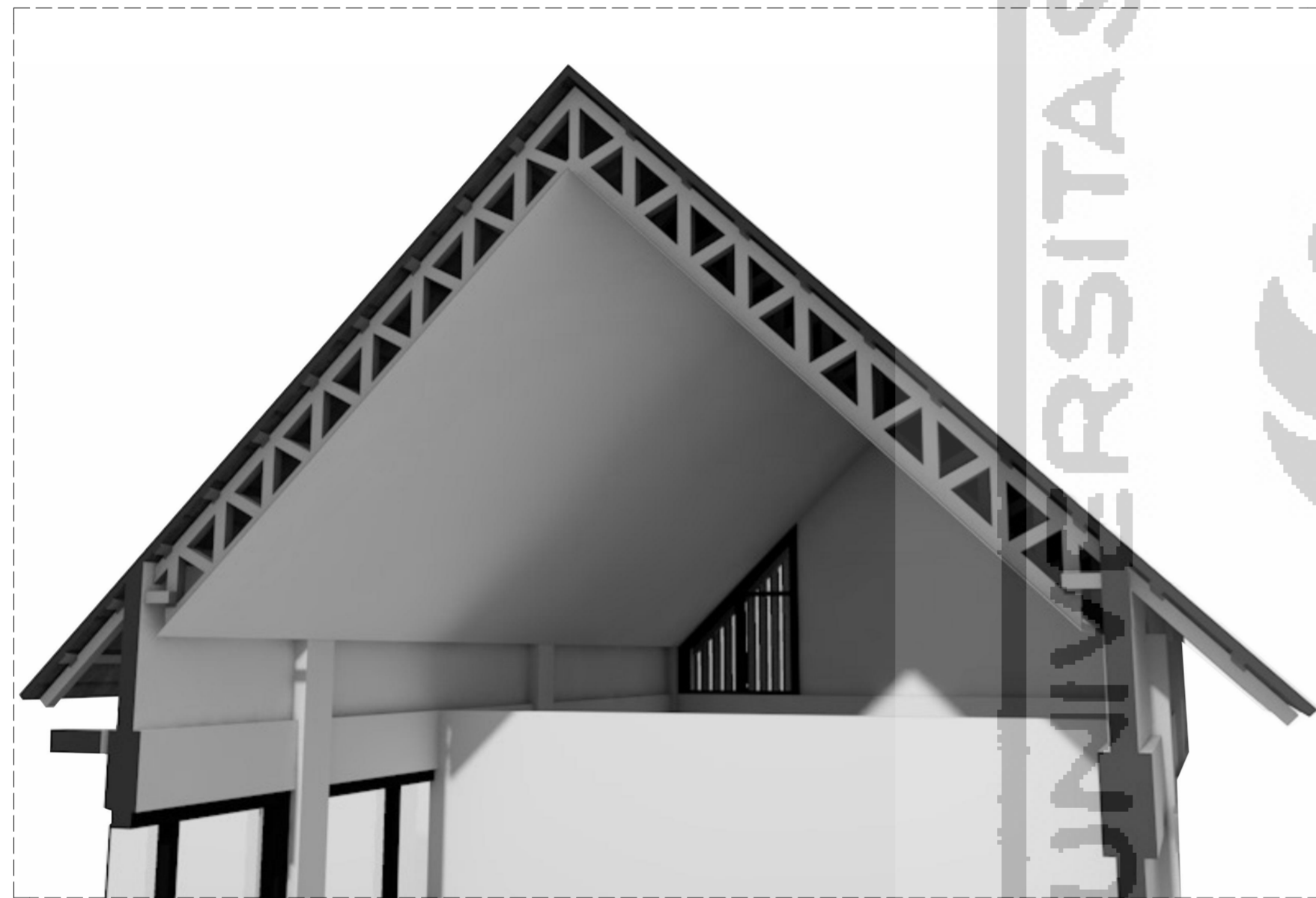

POTONGAN AKSONOMETRI

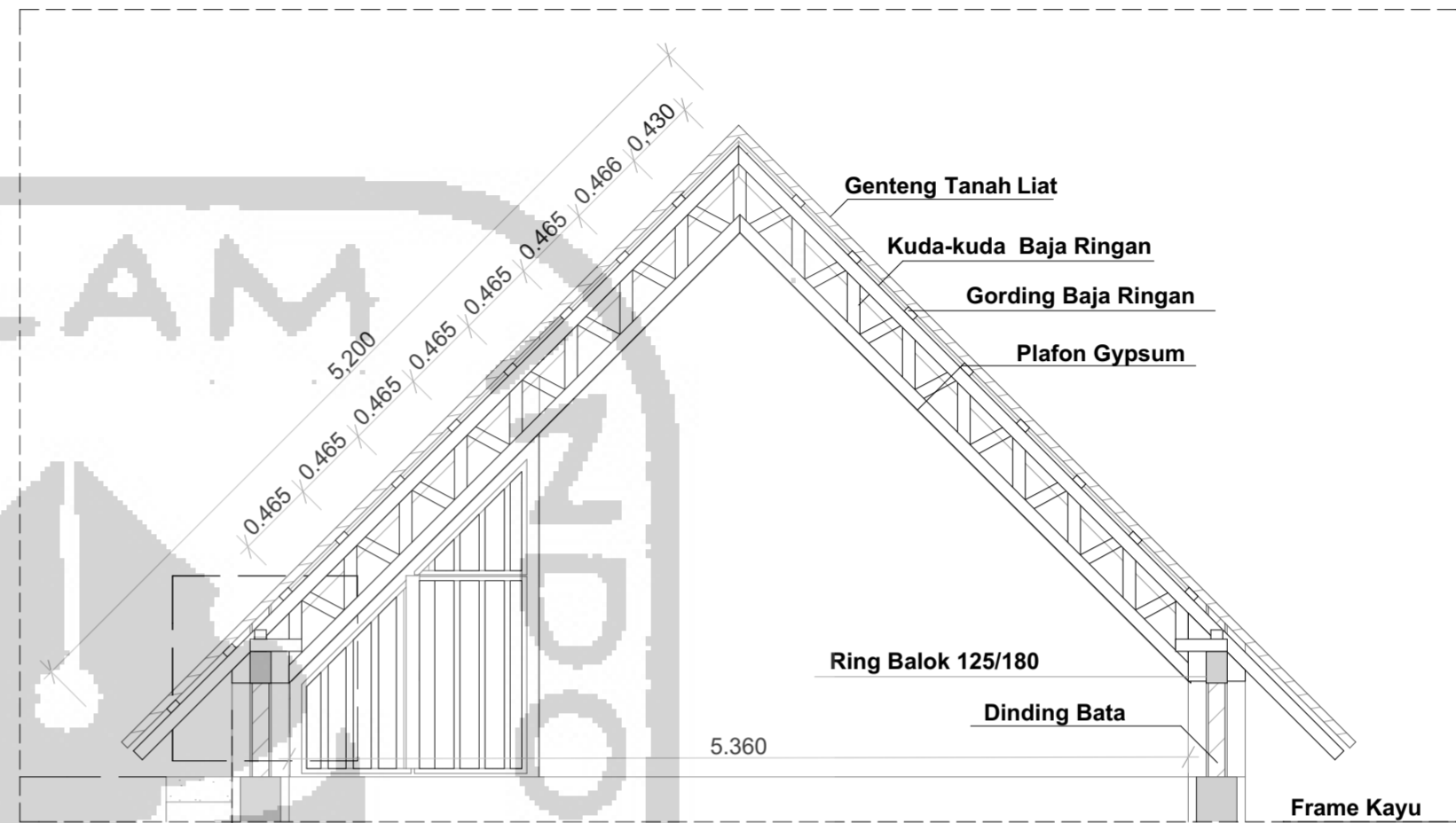

POTONGAN ARSITEKTURAL

1:40

- GENTENG TANAH LIAT
- KUDA-KUDA BAJA RINGAN
- GORDING BAJA RINGAN
- RING BALOK 12,5/18
- DINDING BATA
- KOLOM UTAMA 34/34
- PLAFON GYPSUM

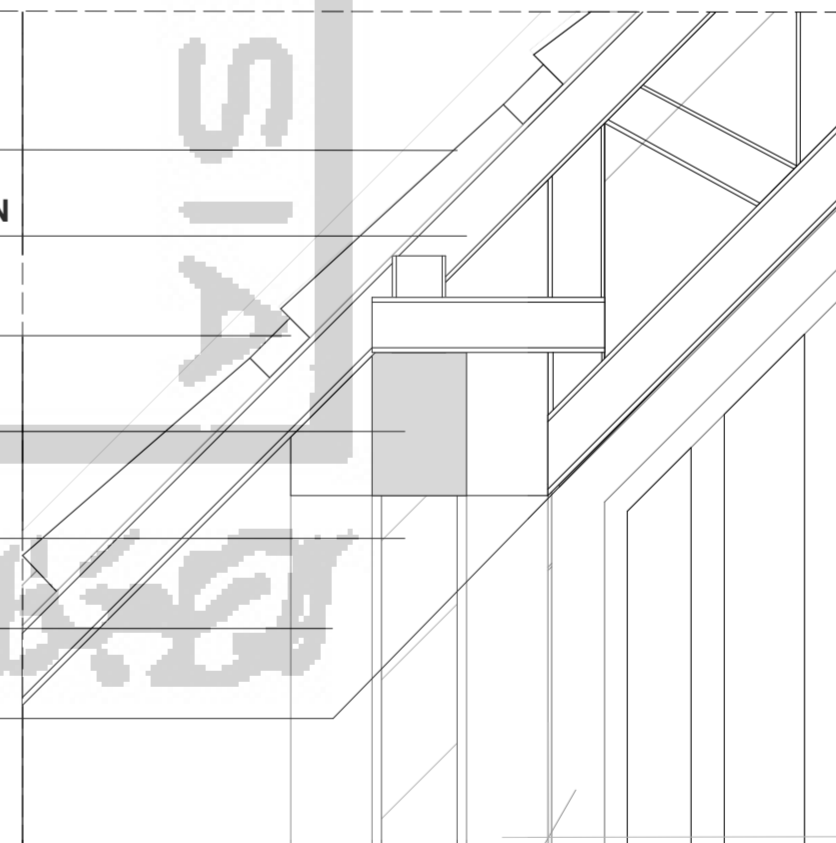

DETAIL ARSITEKTURAL

1:10



DETAIL ARSITEKTURAL 1



الجامعة الإسلامية
INDONESIA

BACHELOR FINAL PROJECT
DEPARTEMENT OF ARCHITECTURE
FACULTY OF CIVIL ENGINEERING
AND
PLANNING

PROJECT

DESIGN OF KOTAGEDE CULTURAL
CENTER IN YOGYAKARTA WITH
ADAPTIVE REUSE AND ADDITION AS
CONSERVATION STRATEGIES

LECTURER

DR. ING- PUTU AYU P. AGUSTIANANDA,
S.T, M.A

NAME

MUHAMAD ARIF SELGI PRABOWO

NIM

15512158

TITLE

DETAIL ARSITEKTURAL 2

SCALE

NO.	TOTAL

INFORMATION



POTONGAN AKSONOMETRI

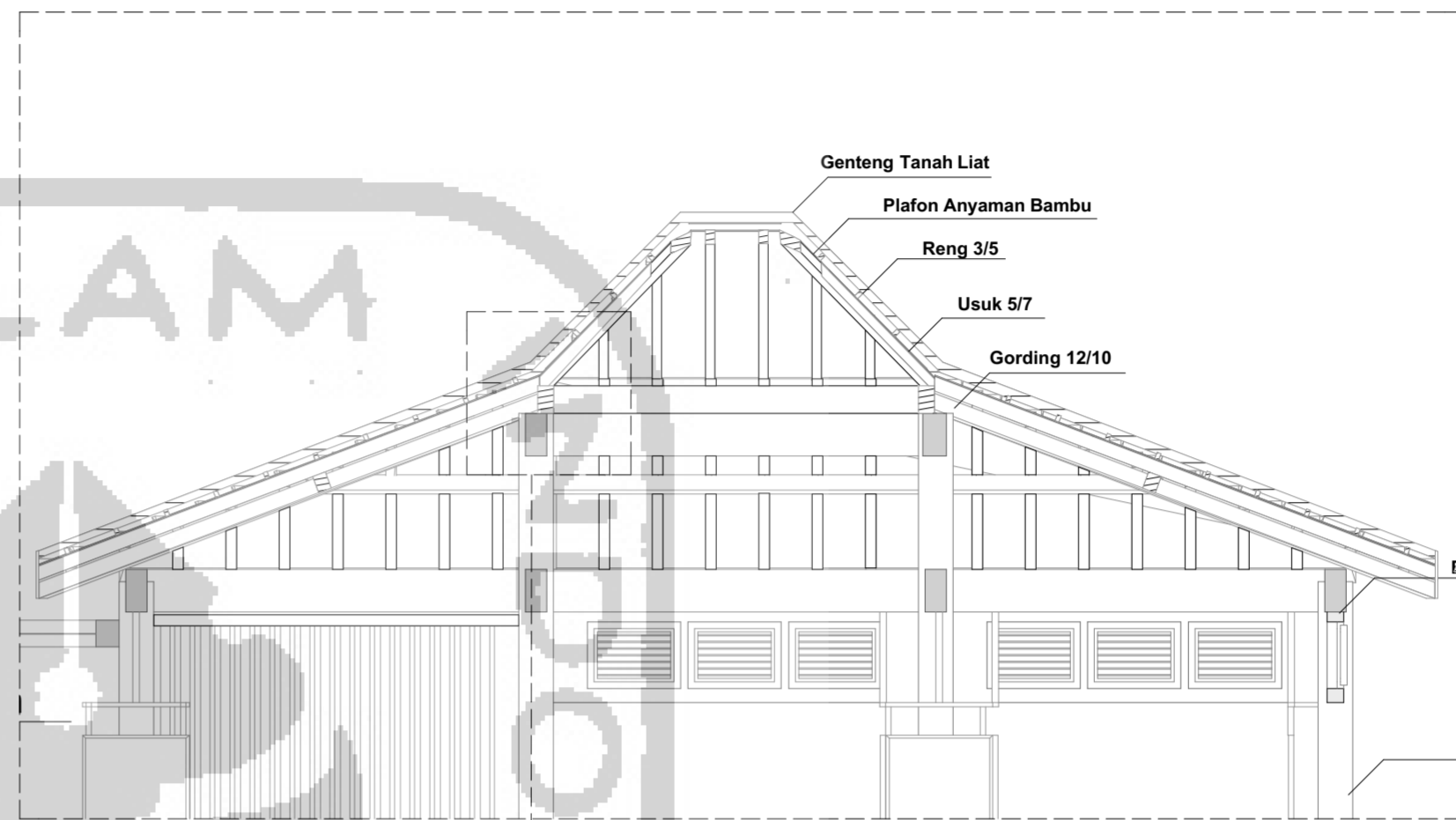

POTONGAN ARSITEKTURAL
1:50

GENTENG TANAH LIAT

PLAFON ANYAMAN BAMBU

BALOK KAYU 20/12

PLAT BESI

GORDING 12/8

BALOK BETON 32/16

KOLOM BETON 26/26

USUK 10/8

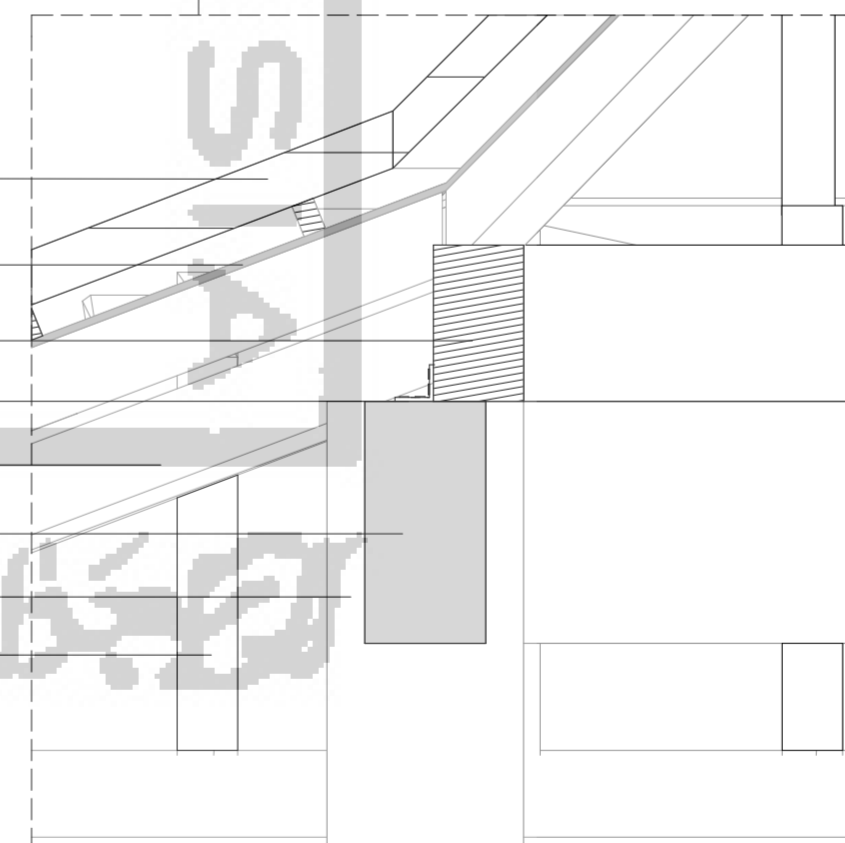

DETAIL ARSITEKTURAL
1:10



DETAIL ARSITEKTURAL 2



UNIVERSITAS ISLAM INDONESIA

BACHELOR FINAL PROJECT
DEPARTEMENT OF ARCHITECTURE
FACULTY OF CIVIL ENGINEERING
AND PLANNING

PROJECT

DESIGN OF KOTAGEDE CULTURAL
CENTER IN YOGYAKARTA WITH
ADAPTIVE REUSE AND ADDITION AS
CONSERVATION STRATEGIES

LECTURER

DR. ING- PUTU AYU P. AGUSTIANANDA,
S.T, M.A

NAME

MUHAMAD ARIF SELGI PRABOWO

NIM

15512158

TITLE

DETAIL ARSITEKTURAL 3

SCALE

NO.	TOTAL

INFORMATION

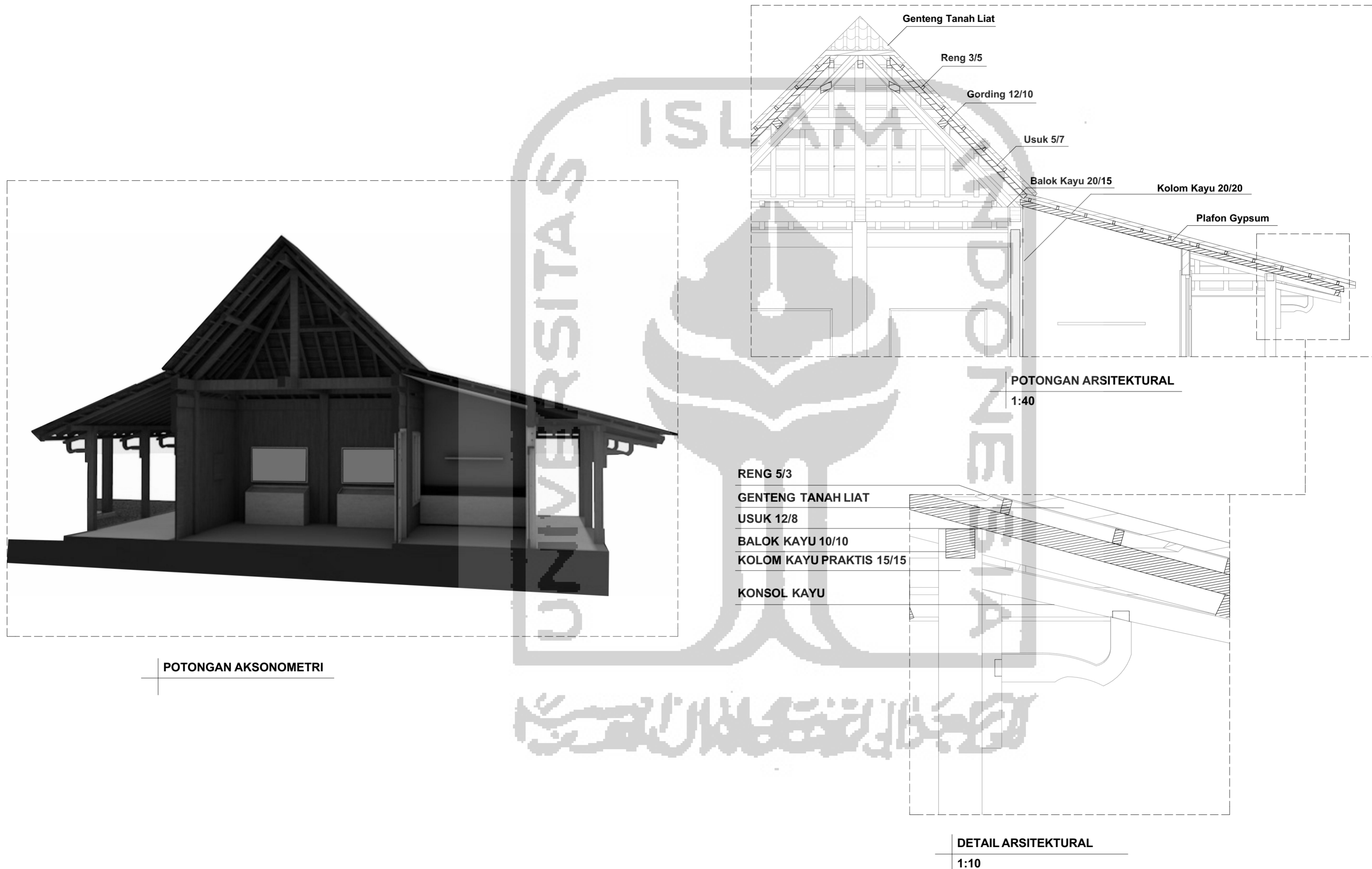



UNIVERSITAS ISLAM INDONESIA

BACHELOR FINAL PROJECT
DEPARTEMENT OF ARCHITECTURE
FACULTY OF CIVIL ENGINEERING
AND PLANNING

PROJECT

DESIGN OF KOTAGEDE CULTURAL
CENTER IN YOGYAKARTA WITH
ADAPTIVE REUSE AND ADDITION AS
CONSERVATION STRATEGIES

LECTURER

DR. ING- PUTU AYU P. AGUSTIANANDA,
S.T., M.A

NAME

MUHAMAD ARIF SELGI PRABOWO

NIM

15512158

TITLE

DETAIL ARSITEKTURAL 4

SCALE

NO.	TOTAL

INFORMATION

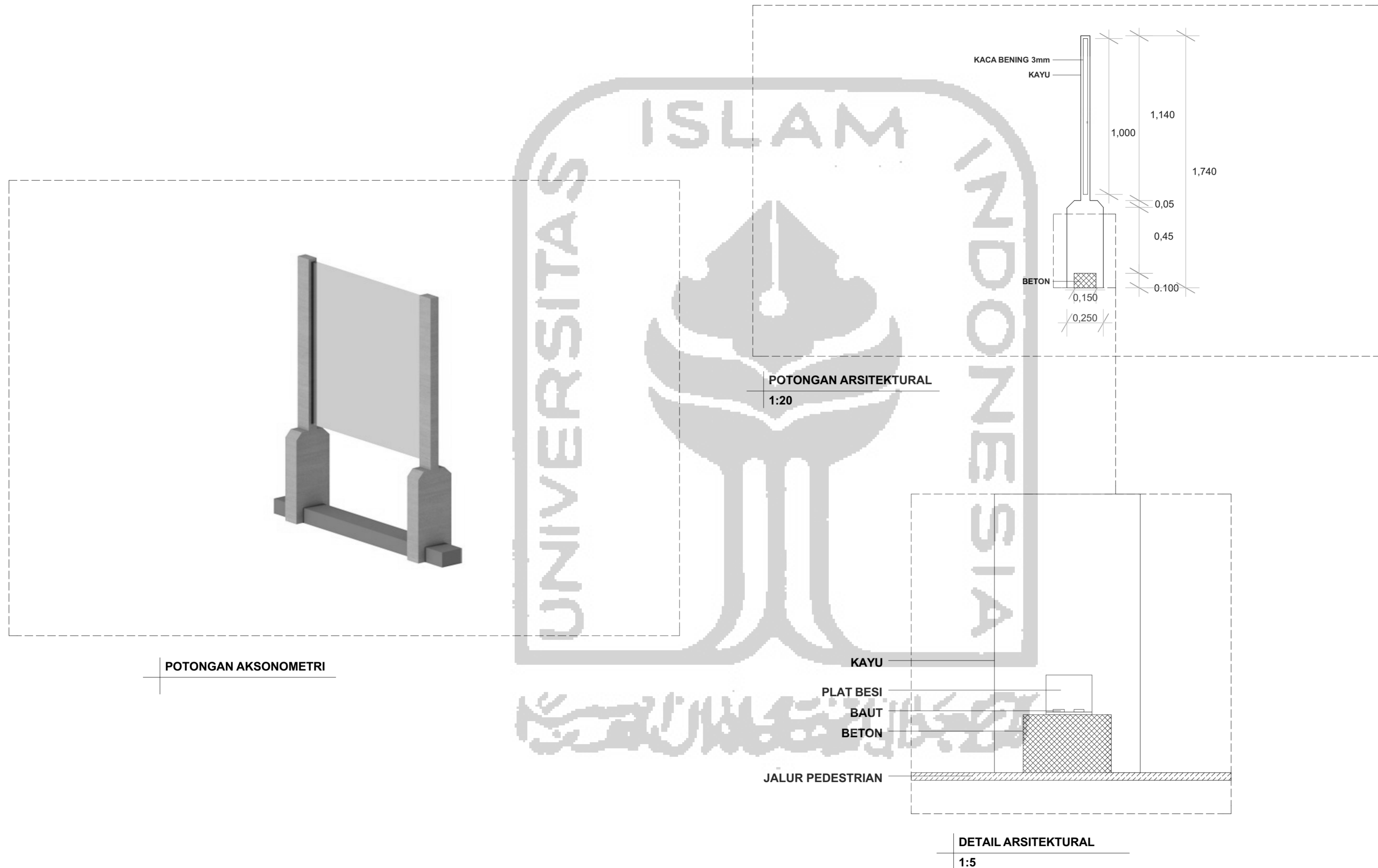



UNIVERSITAS ISLAM INDONESIA

BACHELOR FINAL PROJECT
DEPARTEMENT OF ARCHITECTURE
FACULTY OF CIVIL ENGINEERING
AND PLANNING

PROJECT

DESIGN OF KOTAGEDE CULTURAL
CENTER IN YOGYAKARTA WITH
ADAPTIVE REUSE AND ADDITION AS
CONSERVATION STRATEGIES

LECTURER

DR. ING- PUTU AYU P. AGUSTIANANDA,
S.T., M.A

NAME

MUHAMAD ARIF SELGI PRABOWO

NIM

15512158

TITLE

DETAIL ARSITEKTURAL 5

SCALE

NO.	TOTAL

INFORMATION



POTONGAN AXONOMETRI

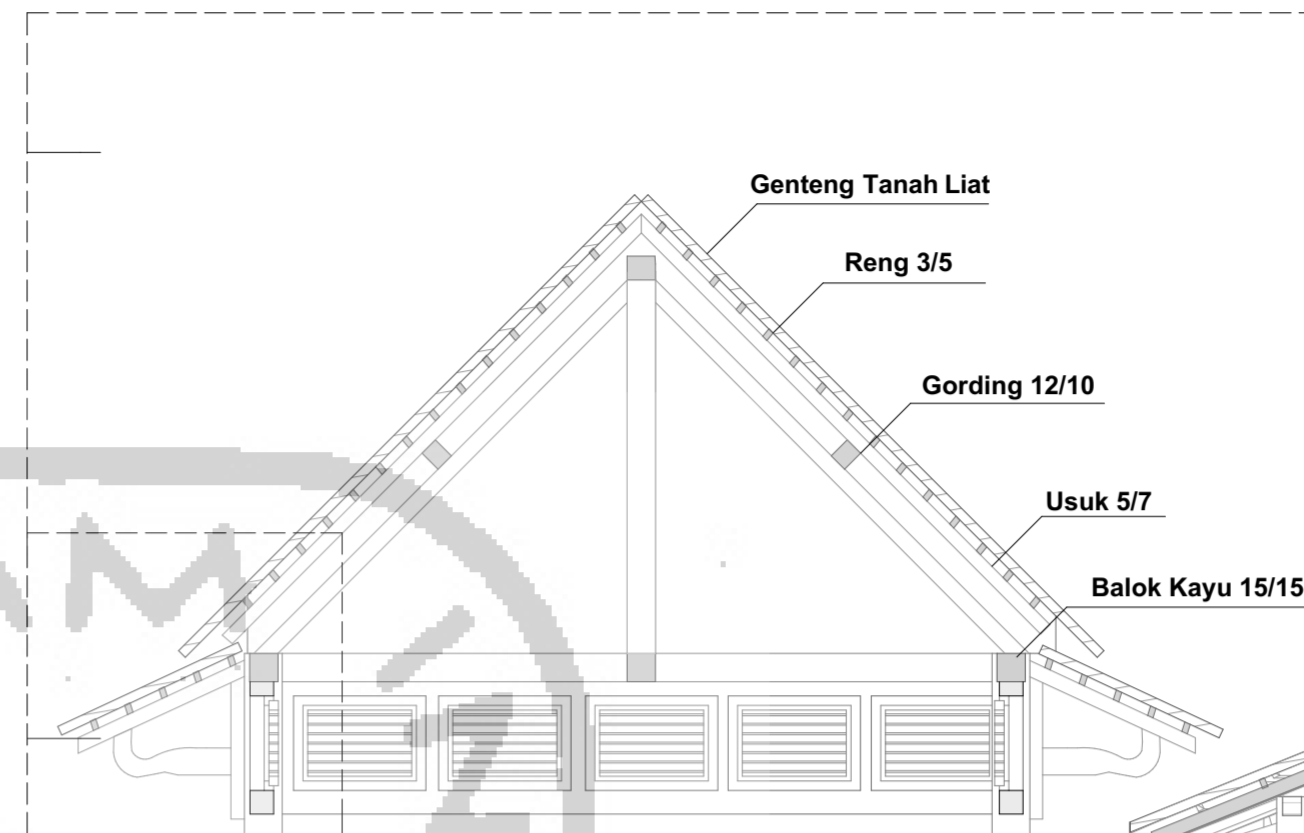

DETAIL ARSITEKTURAL

1:40

KAYU
RENG 3/5
GENTENG TANAH LIAT
VENTILASI KAYU
KONSOL KAYU

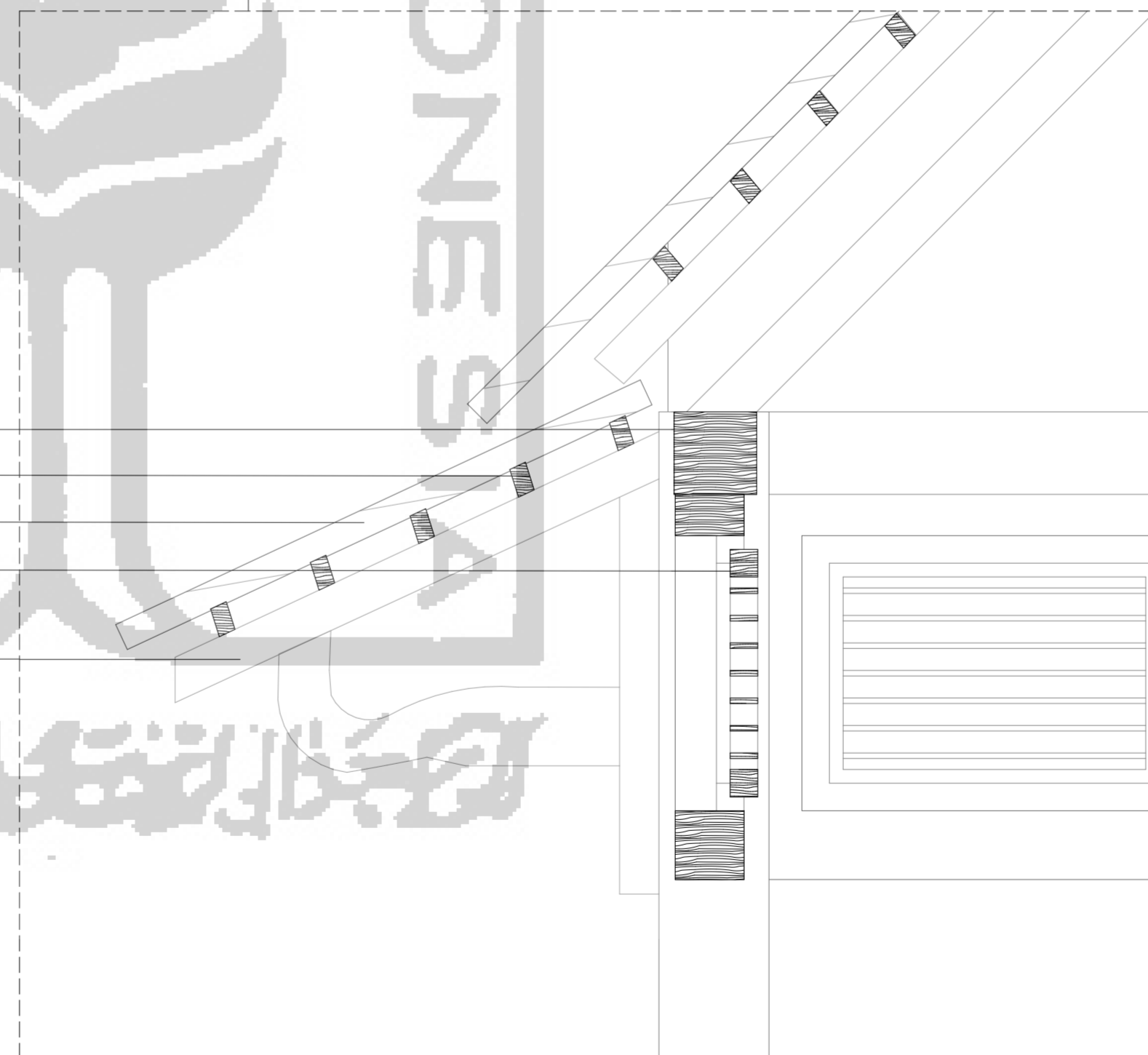

DETAIL ARSITEKTURAL

1:10

DETAIL ARSITEKTURAL 5



BACHELOR FINAL PROJECT
 DEPARTEMENT OF ARCHITECTURE
 FACULTY OF CIVIL ENGINEERING
 AND
 PLANNING

PROJECT

DESIGN OF KOTAGEDE CULTURAL
 CENTER IN YOGYAKARTA WITH
 ADAPTIVE REUSE AND ADDITION AS
 CONSERVATION STRATEGIES

LECTURER

DR. ING- PUTU AYU P. AGUSTIANANDA,
 S.T, M.A

NAME

MUHAMAD ARIF SELGI PRABOWO

NIM

15512158

TITLE

DETAIL ARSITEKTURAL 6

SCALE

NO.	TOTAL

INFORMATION

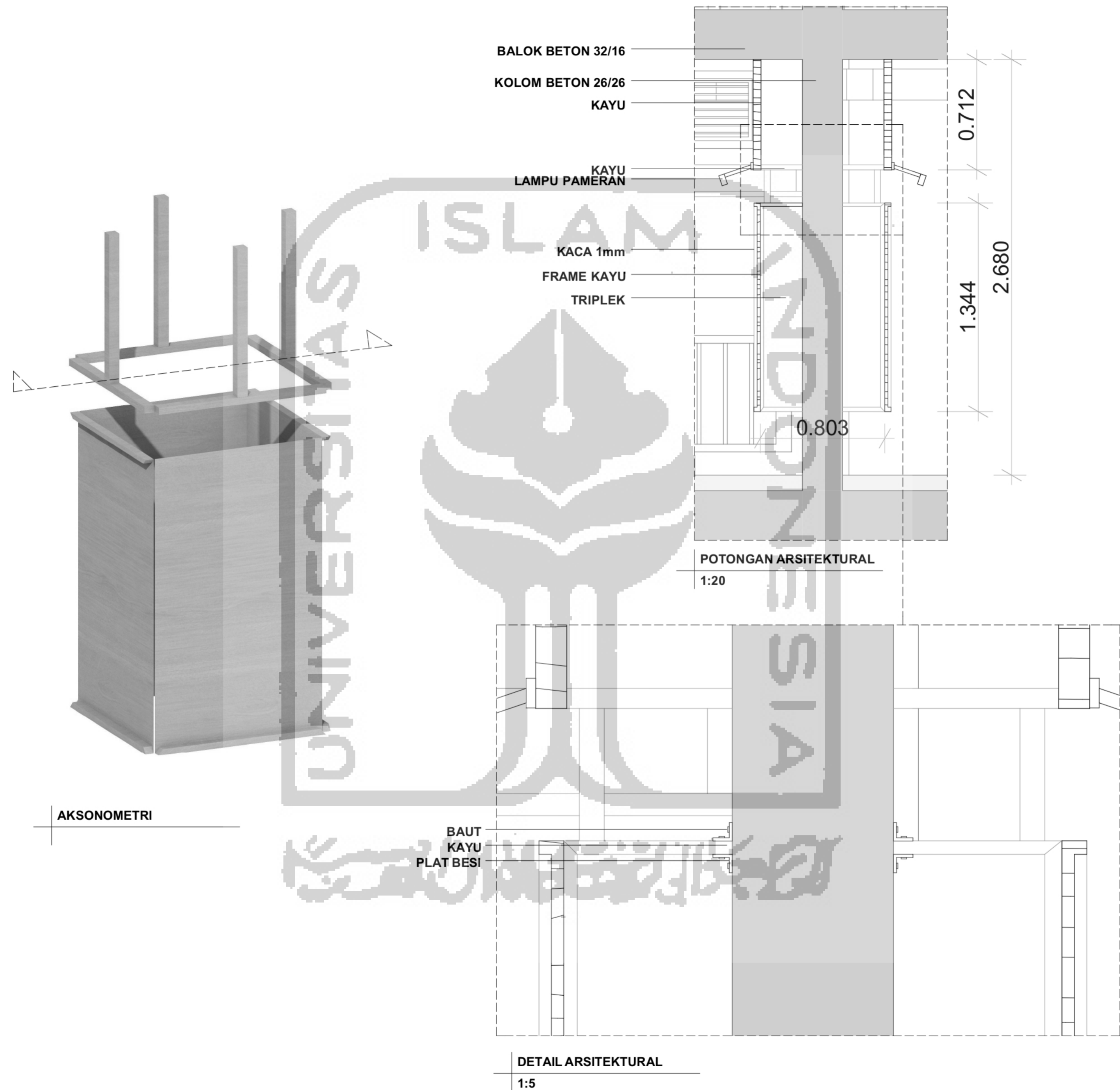

AKSONOMETRI

POTONGAN ARSITEKTURAL
 1:20

DETAIL ARSITEKTURAL
 1:5

DETAIL ARSITEKTURAL 6





BACHELOR FINAL PROJECT
 DEPARTEMENT OF ARCHITECTURE
 FACULTY OF CIVIL ENGINEERING
 AND
 PLANNING

PROJECT

DESIGN OF KOTAGEDE CULTURAL
 CENTER IN YOGYAKARTA WITH
 ADAPTIVE REUSE AND ADDITION AS
 CONSERVATION STRATEGIES

LECTURER

DR. ING- PUTU AYU P. AGUSTIANANDA,
 S.T, M.A

NAME

MUHAMAD ARIF SELGI PRABOWO

NIM

15512158

TITLE

DETAIL ARSITEKTURAL 7

SCALE

NO.	TOTAL

INFORMATION

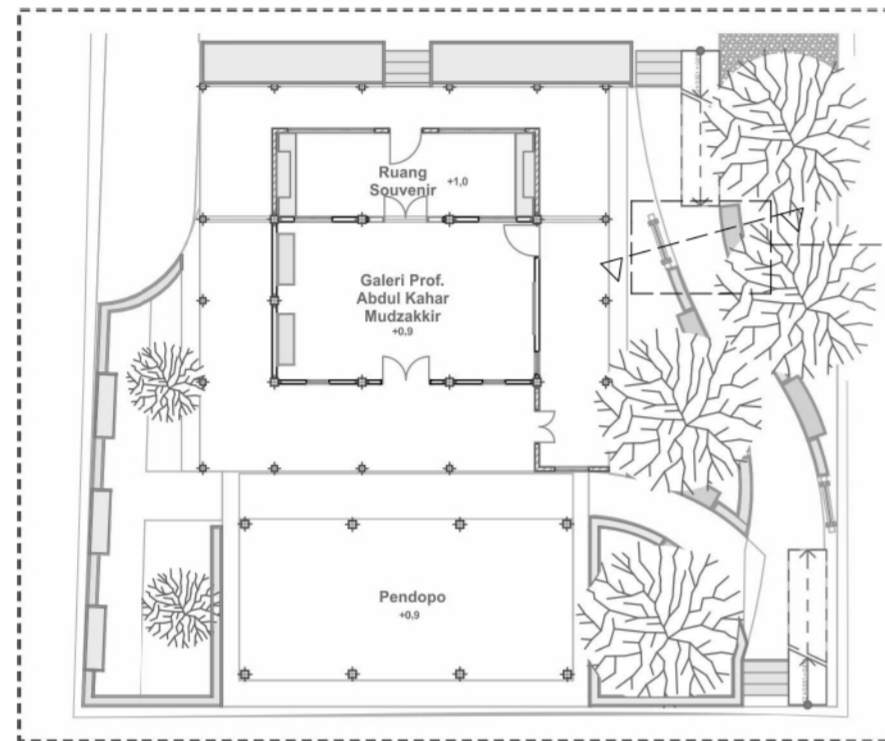

KEY PLAN

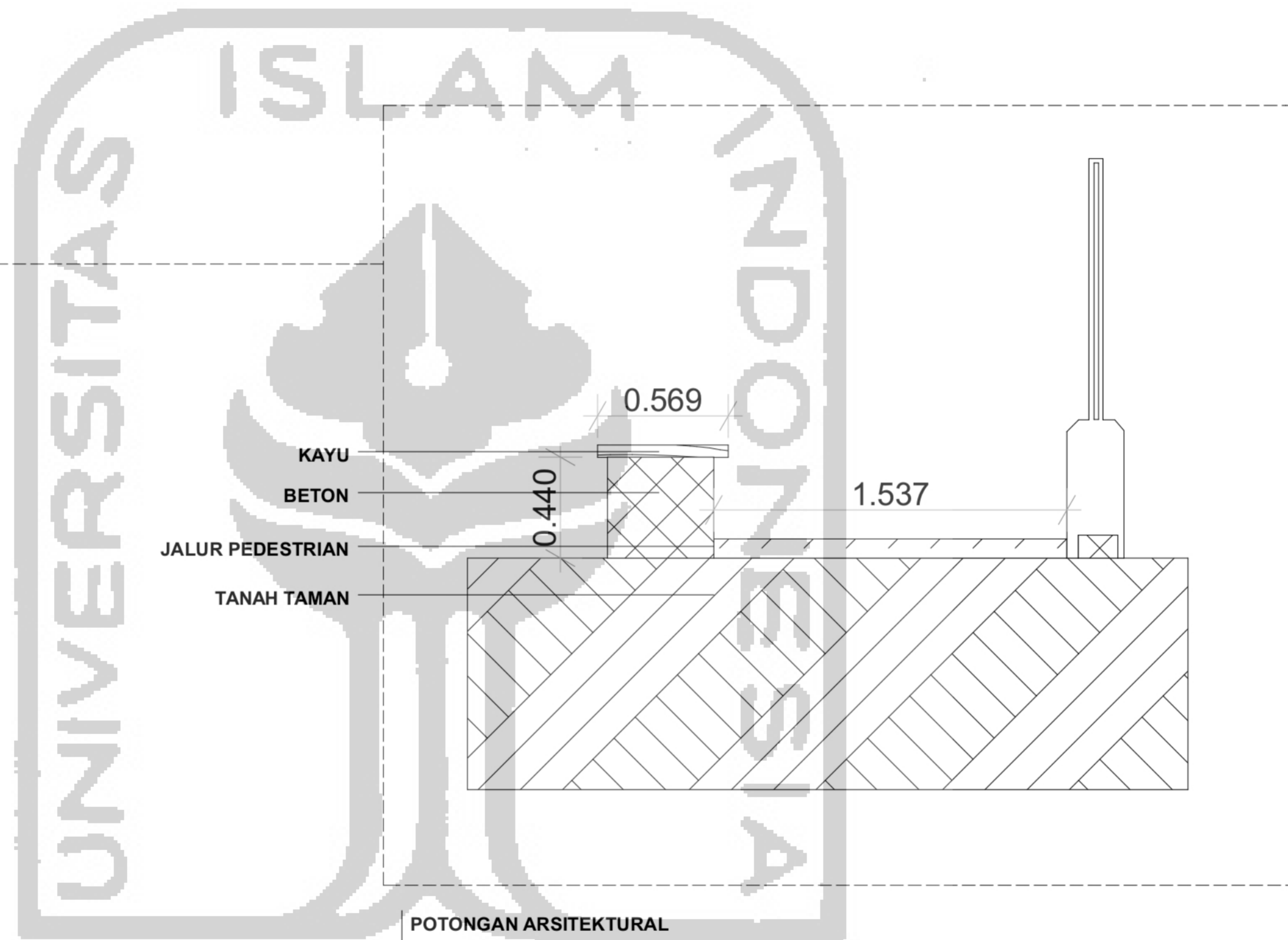

POTONGAN ARSITEKTURAL

1:20





الجامعة الإسلامية
INDONESIA

BACHELOR FINAL PROJECT
DEPARTEMENT OF ARCHITECTURE
FACULTY OF CIVIL ENGINEERING
AND PLANNING

PROJECT

DESIGN OF KOTAGEDE CULTURAL
CENTER IN YOGYAKARTA WITH
ADAPTIVE REUSE AND ADDITION AS
CONSERVATION STRATEGIES

LECTURER

DR. ING- PUTU AYU P. AGUSTIANANDA,
S.T., M.A

NAME

MUHAMAD ARIF SELGI PRABOWO

NIM

15512158

TITLE

EKSTERIOR DAN
INTERIOR
SCALE

NO.

TOTAL

INFORMATION





الجامعة الإسلامية
INDONESIA

BACHELOR FINAL PROJECT
DEPARTMENT OF ARCHITECTURE
FACULTY OF CIVIL ENGINEERING
AND PLANNING

PROJECT

DESIGN OF KOTAGEDE CULTURAL
CENTER IN YOGYAKARTA WITH
ADAPTIVE REUSE AND ADDITION AS
CONSERVATION STRATEGIES

LECTURER

DR. ING- PUTU AYU P. AGUSTIANANDA,
S.T, M.A

NAME

MUHAMAD ARIF SELGI PRABOWO

NIM

15512158

TITLE

**EKSTERIOR DAN
INTERIOR
SCALE**

NO.

TOTAL

INFORMATION





BACHELOR FINAL PROJECT
 DEPARTMENT OF ARCHITECTURE
 FACULTY OF CIVIL ENGINEERING
 AND
 PLANNING

PROJECT

DESIGN OF KOTAGEDE CULTURAL
 CENTER IN YOGYAKARTA WITH
 ADAPTIVE REUSE AND ADDITION AS
 CONSERVATION STRATEGIES

LECTURER

DR. ING- PUTU AYU P. AGUSTIANANDA,
 S.T., M.A

NAME

MUHAMAD ARIF SELGI PRABOWO

NIM

15512158

TITLE

**EKSTERIOR DAN
 INTERIOR
 SCALE**

NO.

TOTAL

INFORMATION

