

REAKTOR (R)

Fungsi : tempat berlangsungnya reaksi dehidrogenasi propana (C₃H₈) menghasilkan propilen (C₃H₆)

Jenis : *Multitube fixedbed reactor*

Kondisi operasi : - T = 600 °C
 - P = 1520 mmHg (2 atm)
 - non adiabatik, isotermal

Katalis : Al₂O₃ (padat)

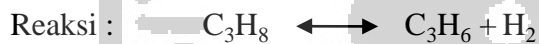

Reaktor yang dipilih adalah jenis *multitube fixedbed* dengan pertimbangan sebagai berikut :

1. Reaksi gas-gas katalis padat.
2. Tidak perlu pemisahan katalis dari gas keluaran reaktor.
3. Konstruksi reaktor lebih sederhana dibandingkan dengan Reaktor *fluidized bed* sehingga biaya pembuatan, operasional, dan perawatannya lebih murah.

Neraca massa di sekitar reaktor

No.	Komponen	BM	Input (F3)		Output (F5)	
			Kmol/jam	Kg/jam	Kmol/jam	Kg/jam
1.	C ₃ H ₆	42,08	7,674	322,326	293,023	12.629,310
2.	C ₃ H ₈	44,09	732,559	32.232,578	439,535	19.339,547
3.	C ₄ H ₁₀	58,12	27,787	1.611,629	27,787	1.611,629
4.	H ₂	2,01	0,0000	0,0000	293,023	586,047
Total			34.166,5333 Kg/jam		34.166,5333 Kg/jam	

Konversi akhir yang diinginkan : 40%

A. Menyusun Persamaan Reaksi

Reaksi yang terjadi :

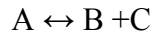
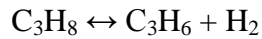

Reaksi dehidrogenasi propana menjadi propilen merupakan reaksi *reversible* dengan kecepatan reaksi:

$$r = a \times k_1 \left(1 - \frac{P_B P_C}{P_A K_{eq1}} \right) \frac{P_A}{P_C^{0.5} + K_{B1} P_B} \frac{\text{kmol}}{\text{s} \cdot \text{m}^3}$$

Dimana :

$$a = 2.600$$

$$K_{eq1} = 8,49 \times 10^8 \exp\left(\frac{-118707}{RT}\right) \text{ kPa}$$

$$k_1 = 0,3874 \exp\left(\frac{-2950}{T}\right) \frac{\text{kmol}}{\text{s} \cdot \text{m}^3 \cdot \text{kPa}^{0.5}}$$

$$K_{B1} = 3,4785 \times 10^{-8} \exp\left(\frac{17200}{T}\right) \text{ kPa}^{0.5}$$

B. Menyusun Neraca Massa dan Panas Sekitar Elemen Massa Katalis

1. Neraca massa propana pada elemen volume sebuah tube

Propana = A

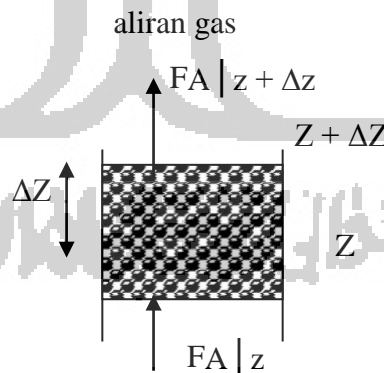

Elemen volume pada sebuah tube : $\pi/4 \times (\text{IDT})^2 \times \Delta Z$

Asumsi : aliran bersifat *plug flow*

: difusi ke arah aksial dan radial diabaikan

: aliran *steady state*

Neraca massa A pada elemen volume tube

Rate of input – Rate of output – Rate of reaction = Rate of accumulation

$$F_{A|z} - F_{A|z+\Delta z} - (-r_A \Delta W) = 0$$

$$\Delta W = \Delta V_t \cdot \rho_B$$

$$\Delta V_t = A_t \cdot \Delta Z$$

$$\Delta V_t = \frac{\pi}{4} (IDt)^2 \cdot \Delta Z$$

$$\Delta W = \frac{\pi}{4} (IDt)^2 \cdot \Delta Z \cdot \rho_B$$

Harga-harga tersebut dimasukkan ke dalam persamaan neraca massa, diperoleh:

$$F_{A|z} - F_{A|z+\Delta z} - \left(-r_A \cdot \frac{\pi}{4} (IDt)^2 \cdot \Delta Z \cdot \rho_B \right) = 0$$

$$F_{A|z} + F_{A|z+\Delta z} = - \left(-r_A \cdot \frac{\pi}{4} (IDt)^2 \cdot \Delta Z \cdot \rho_B \right)$$

Kedua ruas dibagi dengan Δz ,

sehingga:

$$\frac{F_{A|z} + F_{A|z+\Delta z}}{\Delta z} = - \left(-r_A \cdot \frac{\pi}{4} (IDt)^2 \cdot \rho_B \right)$$

Diambil limit Δz mendekati nol, sehingga:

$$\lim_{\Delta z \rightarrow 0} \frac{F_{A|z} + F_{A|z+\Delta z}}{\Delta z} = - \left(-r_A \cdot \frac{\pi}{4} (IDt)^2 \cdot \rho_B \right)$$

Untuk semua tube:

$$\frac{dF_A}{dz} = - \left(-r_A \cdot \frac{\pi}{4} (IDt)^2 \cdot \rho_B \right)$$

$$\frac{dF_A}{dz} = - \left(-r_A \cdot \frac{\pi}{4} (IDt)^2 \cdot \rho_B \right) \cdot Nt$$

$$-F_{A0} \frac{dX_A}{dz} = - \left(-r_A \cdot \frac{\pi}{4} (IDt)^2 \cdot \rho_B \right) \cdot Nt$$

$$F_{A0} \frac{dX_A}{dz} = \left(-r_A \cdot \frac{\pi}{4} (IDt)^2 \cdot \rho_B \right) \cdot Nt$$

$$\frac{dX_A}{dz} = \frac{\left(-r_A \cdot \frac{\pi}{4} (IDt)^2 \cdot \rho_B \right) \cdot Nt}{F_{A0}}$$

Dengan:

W = massa katalis. kg

ρ_B = densitas bulk katalis. kg/m³

- ε = porositas tumpukan katalis. m^3/m^3
 V_t = elemen volume tube. m^3
 IDT = diameter dalam tube. m
 FA_0 = laju alir umpan masuk reaktor. $kmol/jam$
 N_t = jumlah tube
 z = panjang tube dihitung dari atas. m
 $(-r_A)$ = kecepatan reaksi umpan. $kmol/kgkatalis\ jam$
 $\frac{dX_A}{dz}$ = konversi tiap *increment* panjang tube.

2. Neraca panas pereaksi pada elemen volume

Assumsi : *steady state*

Rate of input - Rate of output + Rate of reaction = Rate of accumulation

$$\Sigma Hi|_z - \Sigma Hi|_{z+\Delta z} + U_d \pi \cdot (ID_T) \Delta z (T_p - T) N_t - (\Delta H_R) F_{A0} \Delta x = 0$$

$$\Sigma Hi|_z - \Sigma Hi|_{z+\Delta z} + U_d \pi \cdot (ID_T) \Delta z (T_p - T) N_t - (\Delta H_R) F_{A0} (X|_{z+\Delta z} - X|_z) = 0$$

Kedua ruas dibagi dengan ΔZ diperoleh :

$$\frac{\Sigma Hi|_z - \Sigma Hi|_{z+\Delta z}}{\Delta Z} + (\Delta H_R) F_{A0} \frac{(X|_{z+\Delta z} - X|_z)}{\Delta Z} - U_d \pi \cdot (ID_T) \Delta z (T_p - T) N_t = 0$$

Diambil limit ΔZ mendekati nol, sehingga :

$$\frac{\Sigma dHi}{\Delta Z} + (\Delta H_R) F_{A0} \frac{dx}{\Delta Z} - U_d \pi \cdot (ID_T) \Delta z (T_p - T) N_t = 0$$

$$\Sigma Fi \cdot C_{pi} = U_d \pi \cdot (ID_T) \Delta z (T_p - T) N_t - (\Delta H_R) F_{A0} \frac{dx}{\Delta Z}$$

$$\frac{dT}{dz} = \frac{U_d \pi \cdot (ID_T) \Delta z (T_p - T) N_t - (\Delta H_R) F_{A0} \frac{dx}{\Delta Z}}{\Sigma Fi \cdot C_{pi}}$$

Dengan :

$$(\Delta H) = \Delta H_R + \Delta H_{produk} + \Delta H_{reaktan}$$

ΔH = panas reaksi

$$\Delta H_{produk} = \int C_{p_{produk}} dT$$

Keterangan :

- Fi = laju alir umpan masuk reaktor.kmol/jam
- Cpi = kapasitas panas komponen. kJ/kmol K
- (ΔHR) = panas reaksi pada keadaan standar (298 K). kJ/kmol
- Ud = koefisien perpindahan panas *overall*. kJ/jam m² K
- IDT = diameter dalam tube. m
- Tp = suhu pemanas. K

3. Neraca panas pemanas pada elemen volume

Assumsi : *Steady state*

panas input – panas output - panas yang dilepas = panas terakumulasi

$$W_p.C_{pp}.(T_p | z-T_{ref})-W_p.C_{pp}.(T_p | z+\Delta z-T_{ref})-\pi.(D).\Delta Z.U_d.(T_p-T).N_t=0$$

Kedua ruas dibagi dengan $W_p.C_{pp}.\Delta Z$, sehingga :

$$W_p.C_{pp}.(T_p | z-T_{ref})-W_p.C_{pp}.(T_p | z+\Delta z-T_{ref})-\pi.(D).\Delta Z.U_d.(T_p-T).N_t=0$$

Kedua ruas dibagi dengan $W_p.C_{pp}.\Delta Z$, sehingga :

$$\frac{T_p | z+\Delta z - T_p | z}{\Delta z} = \frac{\pi.D.U_d}{W_p.C_{pp}} (T - T_p).N_t$$

Jika diambil $\Delta Z \rightarrow 0$, diperoleh :

$$\lim_{\Delta z \rightarrow 0} \frac{T_p | z+\Delta z - T_p | z}{\Delta z} = \frac{\pi.D.U_d}{W_p.C_{pp}} (T - T_p).N_t$$

$$\frac{dT_p}{dz} = \frac{\pi.D.U_d}{W_p.C_{pp}} (T - T_p).N_t$$

.....(10)

Keterangan : W_p = kecepatan alir fluida pemanas , kg/jam

C_{pp} = kapasitas panas pemanas

T = suhu gas umpan, K

T_p = suhu pemanas, K

D = diameter rata-rata tube, m

C. Menentukan Jenis, Ukuran dan Susunan Tube

Ukuran *tube* dipilih berdasarkan Rase, H. F., “*Chemical Reactor Design for Process Plant*”. Diameter berkisar antara 1 – 2 in, pada pra rancangan ini

dipilih *tube* dengan ukuran 2 in IPS, Sch. No 40.

- » Diameter dalam *tube* (IDT) = 2,067 in = 0,05256 m
- » Diameter luar *tube* (ODT) = 2,38 in = 0,06045 m
- » *Flow area per tube* ($a't$) = 3,35 in² = 0,0021686 m²
- » Susunan *tube* = *Square pitch*
- » *Pitch* = 2,975 in = 0,07557 m

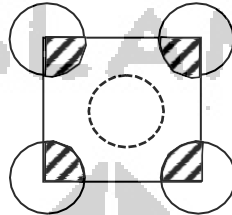

$$C \text{ (Clearance)} = PT - ODT$$

(Kern, hal.138)

$$AT \text{ (Flow area tube)} = \frac{\pi \cdot IDT^2}{4}$$

D. Menentukan Diameter *Shell* dan Jumlah *Tube*

Jumlah *tube* ditentukan sebanyak 2000 *tube*. Diameter *shell* dihitung berdasarkan jumlah *tube* dengan menggunakan persamaan:

$$IDS = \left(\frac{4 \cdot Ass}{\pi} \right)^{0,5}$$

$$Ass = Nt \cdot Pt^2 \cdot 0,866$$

IDS : diameter dalam *shell*, m

Ass : luas penampang *shell*, m²

Nt : jumlah pipa

Pt : *pitch*, m

E. Menentukan *Baffle spacing*, *Diameter Efektif* dan *Flow Area shell*

$$B = (0,2 \sim 1) \cdot IDS \quad (\text{Kern, hal.129})$$

$$= 0,2 \cdot IDS$$

$$De = \frac{4(P_t^2 \cdot 0,5 \cdot 0,86 \cdot \pi \cdot ODT^2)}{0,5 \cdot \pi \cdot ODT} \quad (\text{Kern, pers. 7.5})$$

IDS : Diameter dalam *shell*, m

B: Jarak *baffle*, m

De : Diameter efektif *shell*, m

F. Menghitung Koefisien Perpindahan Panas *Overall*

$$hi = 0.027 \frac{k_T}{D_T} \left(\frac{D_T \cdot G_T}{\mu_T} \right)^{0.8} \left(\frac{cp \cdot \mu_T}{k_T} \right)^{1/3} \quad (\text{Kern, persm. 6.2})$$

$$ho = 0.36 \left(\frac{D_e \cdot G_s}{\mu_s} \right)^{0.55} \left(\frac{cp_s \cdot \mu_s}{k_s} \right)^{1/3} \left(\frac{k_s}{D_e} \right)$$

$$hio = hi \frac{ID}{OD} \quad (\text{Kern, persm. 6.5})$$

$$Uc = \frac{hio \cdot ho}{hio + ho} \quad (\text{Kern, persm. 6.7})$$

$$UD = \frac{Uc}{1 + R_D \cdot Uc} \quad (\text{Kern, pers. 6.10})$$

UC : koefisien perpindahan panas *overall* saat bersih, kJ/jam.m².°K

UD : koefisien perpindahan panas *overall* saat kotor, kJ/jam.m².°K

RD : *Dirt factor* : 0,005 ft². jam.ft².°F/Btu

G. Menentukan Jenis Pemanas

Pemanas yang digunakan adalah *NaK*, dengan data spesifikasi sebagai berikut :

- * *Range* temperatur : -12,6 - 785 °C
- * Kapasitas panas : 0,937 kJ/kgK
- * Konduktivitas panas : 26,2 W/m.K
- * Viskositas : 0,00018 Pa.s

* Densitas : 749 kg/m³

(Kotze, 2012)

H. Menyusun Persamaan Pressure Drop (ΔP) Sepanjang Tumpukan Katalis

Pressure drop pada pipa berisi katalisator dapat didekati dengan persamaan Ergun

$$\frac{gc \cdot dP}{Us \cdot dZ} = 150 \frac{(1-\epsilon)^2}{\epsilon^3} \frac{\mu}{D_p^2} + 1,75 \left(\frac{1-\epsilon}{\epsilon^3} \right) \frac{G}{D_p}$$

gc = kecepatan gravitasi , m/s²

Us = kecepatan aliran gas , m/s

ϵ = porositas

μ = viskositas , kg/m.s

D_p = diameter katalis , m

G = kecepatan massa gas per satuan luas = $Us \cdot \rho$

ρ = massa jenis , kg/m³

persamaan di atas disederhanakan menjadi :

$$\frac{dP}{dz} = \left(1,75 + 150 \frac{(1-\epsilon)^2}{N_{Re}} \right) \left(\frac{1-\epsilon}{\epsilon^2} \right) \frac{\rho \cdot Us^2}{D_p \cdot gc}$$

Kondisi batas :

$Z = 0 ; P = P_0$

$Z = h ; P = P_{out}$

I. Menentukan Katalis yang Digunakan

Bahan = Al₂O₃

Bentuk = Bola

Diameter = 0,003 m

PorositasTumpukan = 0,178

Densitas = 992,25kg/m³

J. Menghitung Tinggi Tumpukan Katalis

Penyelesaian persamaan differensial hubungan XA , T , Tp , P terhadap Z diselesaikan secara numeris dengan pemrograman Scilab dengan algoritma sebagai berikut :

```
// PRA RANCANGAN PABRIK KIMIA PROPILEN DARI PROPANA
// NAILIS SA'ADAH 15521123
// SARAH ANISA RAMADHANI 15521258
clc; clear;

// Reaksi:
// C3H8 ———> C3H6 + H2

// Daftar indeks:
// Indeks Formula Nama
//-----
// A C3H8 Propane
// B C3H6 Propylene
// C H2 Hydrogen
// I C4H10 n-Butane

// Konstanta global
//-----
phi = 3.141592654 ;
R = 0.082;
//-----

// Data katalis
//-----
```

```

Rd = 0.0529/3600; // faktor pengotor (m2.jam/K/kJ)
Dp = 0.003; // diameter butir katalis (m)
Rho = 992.25; // rapat massa katalis (kg/m3)
E = 0.178; // Porositas
//-----

// ukuran pipa
// -----
// Dipilih berdasarkan rase, H.f., "Chemical Reactor Design for Process Plant",
// (1977). John Wiley and Son, inc., N.Y., Vol.1 page 535
// Diameter antara 1-2 inchi

// pada Pra Rancangan ini dipilih: 2 in IPS, Sch. No. 40
//-----
Id1 = 2.067; // diameter dalam (in)
Od1 = 2.38; // diameter luar (in)
Id = Id1*0.0254; // diameter dalam (m)
Od = Od1*0.0254; // Diameter luar (m)
Ap = (phi*Id2)/4; // Luas penampang(m2)
Pitch1 = 1.25*Od1 ;
Pitch = 1.25*Od ;
//-----

// Kondisi Awal
//-----
T1 = 600 ; // Suhu umpan (C)
T = T1+ 273 ; // Suhu umpan (K)
Treff = 298 ; // Suhu referensi (K)
P1 = 2 ; // Tekanan Operasi (atm)
P = P1*101 ; // Tekanan Operasi (kPa)
X = 0 ; // Konversi
k1 = 0.3874*exp((-2950)/T) ;

```

$$keq1 = 8.49e8 * \exp(-118707 / (8.314 * T));$$

$$kb1 = 3.4785e-8 * \exp(17200 / T);$$

$$N_{\text{pipa}} = 2000 ; \quad // \text{ Jumlah pipa sementara di trial}$$

//-----

// Kecepatan umpan masuk [kmol/jam]

//-----

$$FAIO = 732,55859 ; \quad // C_3H_8$$

$$FBIO = 7,6744233 ; \quad // C_3H_6$$

$$FCIO = 0 ; \quad // H_2$$

$$FIIIO = 27,786705 ; \quad // C_4H_{10}$$

//-----

//Kecepatan umpan masuk tiap pipa [kmol/jam]

//-----

$$FA0 = FAIO / N_{\text{pipa}} ; \quad // C_3H_8$$

$$FB0 = FBIO / N_{\text{pipa}} ; \quad // C_3H_6$$

$$FC0 = FCIO / N_{\text{pipa}} ; \quad // H_2$$

$$FI0 = FIIIO / N_{\text{pipa}} ; \quad // C_4H_{10}$$

$$FT0 = FA0 + FB0 + FC0 + FI0; \quad // \text{ laju alir mol total per pipa (kmol/jam)}$$

$$FT0$$

//-----

//Komposisi bahan pada konversi X

//-----

$$FA = FA0 * (1 - X); \quad // C_3H_8$$

$$FB = FB0 + (FA0 * X); \quad // C_3H_6$$

$$FC = FC0 + (FA0 * X); \quad // H_2$$

$$FI = FI0; \quad // C_4H_{10}$$

```

FT = FA + FB + FC + FI; //laju alir mol total per pipa (kmol/jam )
FT
//-----

// Fraksi tiap komponen
//-----
YA = FA/FT ; //C3H8
YB = FB/FT ; //C3H6
YC = FC/FT ; //H2
YI = FI/FT ; // C4H10
//-----

//Berat Molekul komponen (kg/kmol )
BMA = 44 ; //C3H8
BMB = 42 ; // C3H6
BMC = 2 ; // H2
BMI = 58 ; // C4H10

// BM rata-rata [kg/kmol]
bmrt=(FA0/FT0)*BMA +(FB0/FT0)*BMB+(FC0/FT0)*BMC+(FI0/FT0)*BMI;
bmrt
//-----

// Rapat massa gas ( kg/L)
//-----
RhoA = ((P*BMA)/(R*T)); // RHO C3H8
RhoB = ((P*BMB)/(R*T)) ; // RHO C3H6
RhoC = ((P*BMC)/(R*T)) ; // RHO H2
RhoI = ((P*BMI)/(R*T)) ; // Rho C4H10
RhoCamp = 1/(YA/RhoA+YB/RhoB+YC/RhoC+YI/RhoI);
//-----

```

//Kecepatan massa umpan masuk [kg/jam]

//-----

$$\text{masA} = \text{FAIO} * \text{BMA} ; \quad // \text{C}_3\text{H}_8$$

$$\text{masB} = \text{FBIO} * \text{BMB} ; \quad // \text{C}_3\text{H}_6$$

$$\text{masC} = \text{FCIO} * \text{BMC} ; \quad // \text{H}_2$$

$$\text{masI} = \text{FIIO} * \text{BMI} ; \quad // \text{C}_4\text{H}_{10}$$

$$\text{sigmaMas} = \text{masA} + \text{masB} + \text{masC} + \text{masI};$$

//-----

//Kecepatan volume masuk reaktor [L/jam]

//-----

$$\text{volA} = \text{masA} / \text{RhoA} ; \quad // \text{C}_3\text{H}_8$$

$$\text{volB} = \text{masB} / \text{RhoB} ; \quad // \text{C}_3\text{H}_6$$

$$\text{volC} = \text{masC} / \text{RhoC} ; \quad // \text{H}_2$$

$$\text{volI} = \text{masI} / \text{RhoI} ; \quad // \text{C}_4\text{H}_{10}$$

$$\text{sigmaVolm} = \text{volA} + \text{volB} + \text{volC} + \text{volI};$$

$$\text{sigmaVolm}$$

//-----

//Viskositas gas [kg/jam.m]

//-----

$$\text{VA} = (-5.642 + 3.2722e-1 * T - 1.0872e-4 * T^2) * 1e-7 * 3600 ; \quad // \text{visko C}_3\text{H}_8$$

$$\text{VB} = (-7.23 + 3.418e-1 * T - 9.4516e-5 * T^2) * 1e-7 * 3600 ; \quad // \text{visko C}_3\text{H}_6$$

$$\text{VC} = (27.758 + 2.12e-1 * T - 3.28e-5 * T^2) * 1e-7 * 3600 ; \quad // \text{visko H}_2$$

$$\text{VI} = (-4.946 + 2.9001e-1 * T - 6.9665e-5 * T^2) * 1e-7 * 3600 ; \quad // \text{visko C}_4\text{H}_{10}$$

$$\text{VM} = \text{YA} * \text{VA} * \text{BMA}^{0.5} + \text{YB} * \text{VB} * \text{BMB}^{0.5} + \text{YC} * \text{VC} * \text{BMC}^{0.5} + \text{YI} * \text{VI} * \text{BMI}^{0.5};$$

$$\text{VBAH} = \text{YA} * \text{BMA}^{0.5} + \text{YB} * \text{BMB}^{0.5} + \text{YC} * \text{BMC}^{0.5} + \text{YI} * \text{BMI}^{0.5};$$

$$\text{VR} = \text{VM} / \text{VBAH}$$

$$\text{VR}$$

//-----

```

// Kapasitas panas [kJ/kmol/K]
//-----
CPA = (28.227+1.16e-01*T+1.9597e-04*T^2-2.3271e-07*T^3+6.8669e-11*T^4);
//cp C3H8
CPB = (31.298+7.2449E-02*T+1.9481e-04*T^2-2.1582e-07*T^3+6.2974e-11*T^4);
//cp C3H6
CPC = (25.399+2.0178e-02*T-3.8549e-05*T^2+3.188e-08*T^3+8.7585e-11*T^4);
//cp H2
CPI = (20.056+2.8153e-01*T-1.3143e-03*T^2-9.4571e-08*T^3+3.4194e-11*T^4);
//cp C4H10

CPM = (YA*CPA+YB*CPB+YC*CPC+YI*CPI);
//-----

//Konduktivitas thermal {kJ/m.jam.K}
//-----
KA = (-0.00869+6.6409e-05*T+7.876e-08*T^2)*3.6 ; //kond C3H8
KB = (-0.001116+7.5155e-05*T+6.5558e-08*T^2)*3.6 ; //kond C3H6
KC = (-0.03951+4.5918e-04*T-6.4933e-08*T^2)*3.6 ; //kond H2
KI = (-0.00182+1.9396e-05*T+1.3818e-07*T^2)*3.6 ; //kond C4H10

KMa = YA*KA+YB*KB+YC*KC+YI*KI ;
BAWAH = YA+YB+YC+YI ;
KM = KMa/BAWAH ;
//-----

//Kecepatan massa persatuan luas pipa [kg/m^2.jam]
//-----
Gt =(FT0)*bmr/Ap ; // Fluk massa
//-----

//Kecepatan linear [m/jam]

```

```

//-----
vlin = Gt/((sigmaMas/sigmaVolm)*1000) ;
vlin
//-----

//Tube side
//-----
Rep = 52*Gt*Dp/VR; // Bilangan Reynold dalam pipa
Rep
HI = (((CPM*VR/bmrt)/KM)^(1/3)*(KM/Id)*((Dp*Gt)/VR)^(0.8)*0.027);
//[kJ/(m2.jam.K)]
HIO=HI*Id/Od ;
DE = (4*(Pitch^2-((phi*Od^4)/4)))/(phi*Od) ; // Diameter ekuivalen(untuk square
pitch) [m]
//-----

//Media pemanas
//-----
ms = 925353 ; // kecepatan massa pemanas [kg/jam]
D = 727 ; // suhu masuk dalam [C]
Tp = D+273 ; // suhu fluida panas masuk
//-----

//sebagai media pemananjus digunakan NaK
//sifat fisis
//-----
CPP = 0.937 ; // [kJ/kg.K]
KP = 94.32 ; // [kJ/m.jam.K]
VP = 0.648 ; // [kg/m.jam]
//-----

//Shell side

```

```

//-----
Ass = Npipa*Pitch^2*0.866; //LUAS PENAMPANG SHELL (m^2)
ID = (4*Ass/phi)^0.5; // DIAMETER SHELL (m)
BS = ID/5; // JARAK BUFFLE (m)
Pitch = 1.25*Od; //Pitch (m)
cl = Pitch-Od; // CLEARANCE
ASi = ID*cl*BS/Pitch; // LUAS SHELL (m^2)
//-----

//Kecepatan massa per satuan luas dalam shell [kg/jam/m^2]
//-----
GS = ms*Npipa/ASi;
//-----
Res = DE*GS/VP; // Rumus HO di bawah bisa digunakan karena Rs antara 2.000 -
1.000.000
Res
HO = 0.36 * (KP/DE)*((CPP*VP)/KP)^0.33*((DE*GS)/VP)^0.55; // (kJ/(m^2.jam.K))

// Transfer panas secara keseluruhan (kJ/(m^2.jam.K))
//-----
UC = (HIO*HO)/(HIO+HO);
UD = UC/((Rd*UC)+1);
//-----

//Panas reaksi (kJ/kmol) pakai hf 298
//-----
HrA = -103850 ;
HrB = 20420 ;
HrC = 0 ;
Hr = (HrB+HrC)- HrA ;
//-----

```



```

//Integral kapasitas panas [ kJ/kmol]
//-----
function [CPA, CPB, CPC, CPI]=fungsiicp(C)
    CPA = (28.277*(T-Treff)+(1.16e-01)/2*(T^2-Treff^2)+(1.9597e-04)/3*(T^3-Treff^3)-
(2.3271e-07)/4*(T^4-Treff^4 )+(6.8669e-11)/5*(T^5-Treff^5)); //C3H8
    CPB = (31.298*(T-Treff)+(7.2449e-02)/2*(T^2-Treff^2)+(1.94881e-04)/3*(T^3-
Treff^3)-(2.1582e-07)/4*(T^4-Treff^4 )+(6.2974e-11)/5*(T^5-Treff^5)); //C3H6
    CPC = (25.399*(T-Treff)+(2.0178e-02)/2*(T^2-Treff^2)-(3.8549e-05)/3*(T^3-
Treff^3)+(3.188e-08)/4*(T^4-Treff^4 )-(8.7585e-12)/5*(T^5-Treff^5)); //H2
    CPI = (20.056*(T-Treff)+(2.8153e-01)/2*(T^2-Treff^2)-(1.3143e-03)/3*(T^3-
Treff^3)-(9.4571e-08)/4*(T^4-Treff^4 )+(3.4149e-11)/5*(T^5-Treff^5)); //C4H10
endfunction
//-----
function [delH]=fungsiHR(C)
delH=Hr-CPA+CPB+CPC+CPI;
endfunction
//-----

//Persamaan kecepatan reaksi [kmol/m^3.jam]
//-----
Ca = (FA/ sigmaVolm)//*1e-3 ;
Cb = (FB/sigmaVolm)//*1e-3 ;
Cc = (FC/sigmaVolm)//*1e-3 ;
Ci = (FI/sigmaVolm)//*1e-3 ;
Pa = Ca/(R*T) ;
Pb = Cb/(R*T) ;
Pc = Cc/(R*T) ;
Pi = Ci/(R*T) ;
//r = (0.34*k1*(1-(YA*P*YC*P)/(YA*P*keql))*(YA*P/(((YC*P)^0.5)+kb1*YB*P))) ;
//-----

// untuk keperluan pers4 (Penurunan tekanan)

```

```

//-----
fk = 1+(150/1.75)*(DE*Gt/VR)^-1*(1-E) ;
RM = P*bmrt / (T+273)/0.08205 ; // RAPAT MASSA CCAMPURAN GAS [ kg/m^3]
gC = 6.67e-11; // konstanta gravitasi [m^3/kg.s^2]
c = (1.75e10/144*gC)*((1-E)/E^3) ;
//-----

//-----
disp('-----')
disp(' dz x1 P ')
disp('-----')
//-----

//-----
function[f1,f2,f3,f4]=fungsi(za,X,C,D,Pd)
f1 = phi*Id^2*2600*k1*(1-((FB0+FA0*X)/FT*P*FA0*X/FT*P)/((FA0-
FA0*X)/FT*P*keql))*((FA0-
FA0*X)/FT*P/((FA0*X/FT*P)^0.5+kb1*(FB0+FA0*X)/FT*P))/(4*FA0) ;
f2 = ((delH*FA0*f1)-(UD*phi*Od*(C-D)))/sigmaCP ;
f3 = (UD*phi*Od*Npipa*(C-D))/(ms*CPP) ;
f4 = -(fk*c*Gt^2/(RM*DE))*10^-10 ;
endfunction
//-----

//-----
X1 = 0; C1=T1 ; D1=D; za1=0; za2=15; n=300; Pd1=2;
h = (za2-za1)/n ;
X = X1; za=za1; C=C1; D=D1; Pd=Pd1;
//-----

//-----
while za<=za2

```

```

[CPA, CPB, CPC, CPI]=fungsicp(C);
sigmaCP=(FA*CPA+FB*CPB+FC*CPC+FI*CPI);
[delH]=fungsiHR(C);
[f1,f2,f3,f4]=fungsi(za,X,C,D,Pd);
//-----
Xnext = X+f1*h ;
Cnext = C+f2*h ;
Dnext = D+f3*h ;
Pdnext = Pd+f4*h ;
zanext = za+h ;
//-----
printf('% 10.4f % 10.4f % 10.4f\n',za,X,Pd)
za = zanext;X=Xnext;Pd;Pdnext;
//-----
plot(za,X,'b+:')
//xlabel('Tinggi katalis')
//ylabel('Konversi')
//-----
end

Dz      xi      p
0.0000  0.0000  2.0000
0.0500  0.0847  2.0000
0.1000  0.0923  1.9999
0.1500  0.0991  1.9999
0.2000  0.1055  1.9999
0.2500  0.1115  1.9998
0.3000  0.1171  1.9998
0.3500  0.1224  1.9998
0.4000  0.1274  1.9997

```

0.4500	0.1322	1.9997
0.5000	0.1368	1.9997
0.5500	0.1412	1.9996
0.6000	0.1454	1.9996
0.6500	0.1495	1.9996
0.7000	0.1534	1.9996
0.7500	0.1572	1.9995
0.8000	0.1609	1.9995
0.8500	0.1644	1.9995
0.9000	0.1679	1.9994
0.9500	0.1713	1.9994
1.0000	0.1745	1.9994
1.0500	0.1777	1.9993
1.1000	0.1808	1.9993
1.1500	0.1838	1.9993
1.2000	0.1868	1.9992
1.2500	0.1897	1.9992
1.3000	0.1925	1.9992
1.3500	0.1952	1.9991
1.4000	0.1979	1.9991
1.4500	0.2006	1.9991
1.5000	0.2032	1.9990
1.5500	0.2057	1.9990
1.6000	0.2082	1.9990
1.6500	0.2106	1.9989
1.7000	0.2130	1.9989
1.7500	0.2153	1.9989
1.8000	0.2176	1.9988
1.8500	0.2199	1.9988
1.9000	0.2221	1.9988
1.9500	0.2243	1.9987
2.0000	0.2264	1.9987



2.0500	0.2285	1.9987
2.1000	0.2306	1.9987
2.1500	0.2326	1.9986
2.2000	0.2346	1.9986
2.2500	0.2366	1.9986
2.3000	0.2385	1.9985
2.3500	0.2404	1.9985
2.4000	0.2423	1.9985
2.4500	0.2442	1.9984
2.5000	0.2460	1.9984
2.5500	0.2478	1.9984
2.6000	0.2495	1.9983
2.6500	0.2513	1.9983
2.7000	0.2530	1.9983
2.7500	0.2547	1.9982
2.8000	0.2564	1.9982
2.8500	0.2580	1.9982
2.9000	0.2597	1.9981
2.9500	0.2613	1.9981
3.0000	0.2628	1.9981
3.0500	0.2644	1.9980
3.1000	0.2659	1.9980
3.1500	0.2675	1.9980
3.2000	0.2690	1.9979
3.2500	0.2705	1.9979
3.3000	0.2719	1.9979
3.3500	0.2734	1.9979
3.4000	0.2748	1.9978
3.4500	0.2762	1.9978
3.5000	0.2776	1.9978
3.5500	0.2790	1.9977
3.6000	0.2803	1.9977



3.6500	0.2817	1.9977
3.7000	0.2830	1.9976
3.7500	0.2843	1.9976
3.8000	0.2856	1.9976
3.8500	0.2869	1.9975
3.9000	0.2881	1.9975
3.9500	0.2894	1.9975
4.0000	0.2906	1.9974
4.0500	0.2919	1.9974
4.1000	0.2931	1.9974
4.1500	0.2943	1.9973
4.2000	0.2954	1.9973
4.2500	0.2966	1.9973
4.3000	0.2978	1.9972
4.3500	0.2989	1.9972
4.4000	0.3001	1.9972
4.4500	0.3012	1.9971
4.5000	0.3023	1.9971
4.5500	0.3034	1.9971
4.6000	0.3045	1.9971
4.6500	0.3055	1.9970
4.7000	0.3066	1.9970
4.7500	0.3076	1.9970
4.8000	0.3087	1.9969
4.8500	0.3097	1.9969
4.9000	0.3107	1.9969
4.9500	0.3117	1.9968
5.0000	0.3127	1.9968
5.0500	0.3137	1.9968
5.1000	0.3147	1.9967
5.1500	0.3157	1.9967
5.2000	0.3166	1.9967



5.2500	0.3176	1.9966
5.3000	0.3185	1.9966
5.3500	0.3194	1.9966
5.4000	0.3204	1.9965
5.4500	0.3213	1.9965
5.5000	0.3222	1.9965
5.5500	0.3231	1.9964
5.6000	0.3240	1.9964
5.6500	0.3248	1.9964
5.7000	0.3257	1.9963
5.7500	0.3266	1.9963
5.8000	0.3274	1.9963
5.8500	0.3283	1.9962
5.9000	0.3291	1.9962
5.9500	0.3299	1.9962
6.0000	0.3308	1.9962
6.0500	0.3316	1.9961
6.1000	0.3324	1.9961
6.1500	0.3332	1.9961
6.2000	0.3340	1.9960
6.2500	0.3347	1.9960
6.3000	0.3355	1.9960
6.3500	0.3363	1.9959
6.4000	0.3371	1.9959
6.4500	0.3378	1.9959
6.5000	0.3386	1.9958
6.5500	0.3393	1.9958
6.6000	0.3400	1.9958
6.6500	0.3408	1.9957
6.7000	0.3415	1.9957
6.7500	0.3422	1.9957
6.8000	0.3429	1.9956



6.8500	0.3436	1.9956
6.9000	0.3443	1.9956
6.9500	0.3450	1.9955
7.0000	0.3457	1.9955
7.0500	0.3464	1.9955
7.1000	0.3470	1.9954
7.1500	0.3477	1.9954
7.2000	0.3484	1.9954
7.2500	0.3490	1.9954
7.3000	0.3497	1.9953
7.3500	0.3503	1.9953
7.4000	0.3510	1.9953
7.4500	0.3516	1.9952
7.5000	0.3522	1.9952
7.5500	0.3528	1.9952
7.6000	0.3535	1.9951
7.6500	0.3541	1.9951
7.7000	0.3547	1.9951
7.7500	0.3553	1.9950
7.8000	0.3559	1.9950
7.8500	0.3565	1.9950
7.9000	0.3570	1.9949
7.9500	0.3576	1.9949
8.0000	0.3582	1.9949
8.0500	0.3588	1.9948
8.1000	0.3593	1.9948
8.1500	0.3599	1.9948
8.2000	0.3605	1.9947
8.2500	0.3610	1.9947
8.3000	0.3616	1.9947
8.3500	0.3621	1.9946
8.4000	0.3627	1.9946



8.4500	0.3632	1.9946
8.5000	0.3637	1.9946
8.5500	0.3642	1.9945
8.6000	0.3648	1.9945
8.6500	0.3653	1.9945
8.7000	0.3658	1.9944
8.7500	0.3663	1.9944
8.8000	0.3668	1.9944
8.8500	0.3673	1.9943
8.9000	0.3678	1.9943
8.9500	0.3683	1.9943
9.0000	0.3688	1.9942
9.0500	0.3693	1.9942
9.1000	0.3698	1.9942
9.1500	0.3702	1.9941
9.2000	0.3707	1.9941
9.2500	0.3712	1.9941
9.3000	0.3717	1.9940
9.3500	0.3721	1.9940
9.4000	0.3726	1.9940
9.4500	0.3730	1.9939
9.5000	0.3735	1.9939
9.5500	0.3739	1.9939
9.6000	0.3744	1.9938
9.6500	0.3748	1.9938
9.7000	0.3753	1.9938
9.7500	0.3757	1.9937
9.8000	0.3761	1.9937
9.8500	0.3766	1.9937
9.9000	0.3770	1.9937
9.9500	0.3774	1.9936
10.0000	0.3778	1.9936



10.0500	0.3782	1.9936
10.1000	0.3787	1.9935
10.1500	0.3791	1.9935
10.2000	0.3795	1.9935
10.2500	0.3799	1.9934
10.3000	0.3803	1.9934
10.3500	0.3807	1.9934
10.4000	0.3811	1.9933
10.4500	0.3815	1.9933
10.5000	0.3818	1.9933
10.5500	0.3822	1.9932
10.6000	0.3826	1.9932
10.6500	0.3830	1.9932
10.7000	0.3834	1.9931
10.7500	0.3837	1.9931
10.8000	0.3841	1.9931
10.8500	0.3845	1.9930
10.9000	0.3848	1.9930
10.9500	0.3852	1.9930
11.0000	0.3856	1.9929
11.0500	0.3859	1.9929
11.1000	0.3863	1.9929
11.1500	0.3866	1.9929
11.2000	0.3870	1.9928
11.2500	0.3873	1.9928
11.3000	0.3877	1.9928
11.3500	0.3880	1.9927
11.4000	0.3883	1.9927
11.4500	0.3887	1.9927
11.5000	0.3890	1.9926
11.5500	0.3893	1.9926
11.6000	0.3897	1.9926

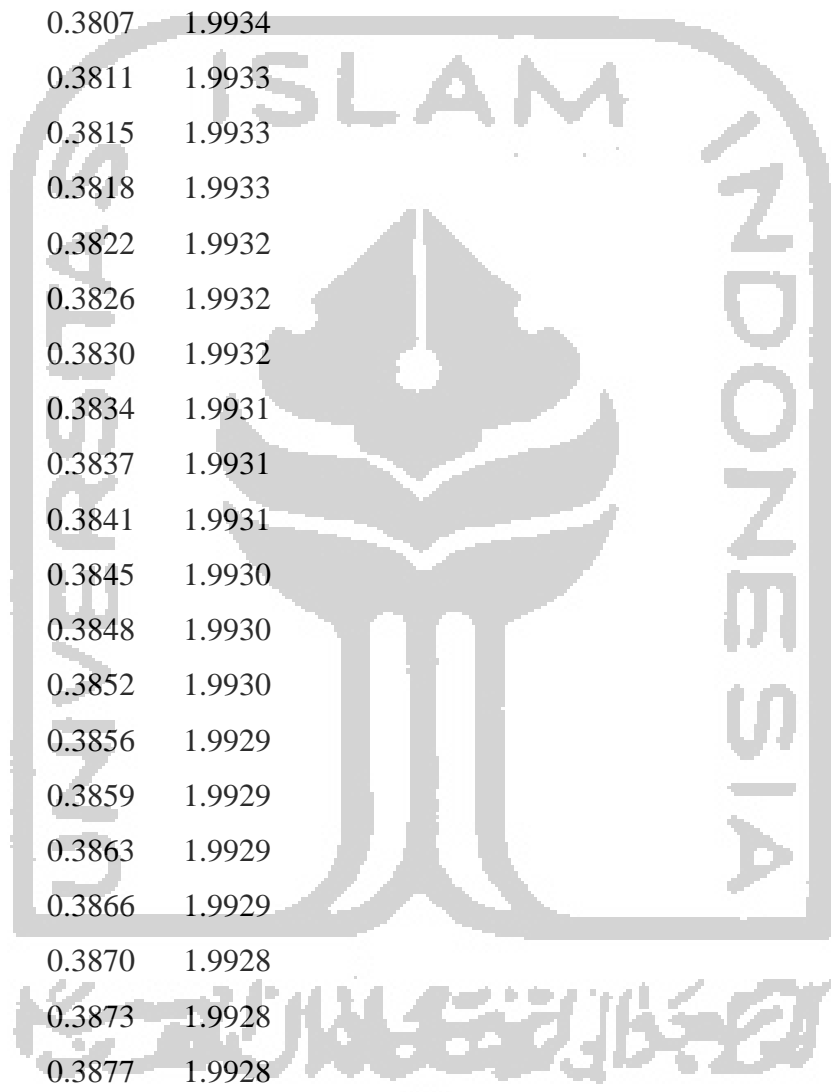

11.6500	0.3900	1.9925
11.7000	0.3903	1.9925
11.7500	0.3906	1.9925
11.8000	0.3910	1.9924
11.8500	0.3913	1.9924
11.9000	0.3916	1.9924
11.9500	0.3919	1.9923
12.0000	0.3922	1.9923
12.0500	0.3925	1.9923
12.1000	0.3928	1.9922
12.1500	0.3931	1.9922
12.2000	0.3934	1.9922
12.2500	0.3937	1.9921
12.3000	0.3940	1.9921
12.3500	0.3943	1.9921
12.4000	0.3946	1.9921
12.4500	0.3949	1.9920
12.5000	0.3952	1.9920
12.5500	0.3955	1.9920
12.6000	0.3957	1.9919
12.6500	0.3960	1.9919
12.7000	0.3963	1.9919
12.7500	0.3966	1.9918
12.8000	0.3969	1.9918
12.8500	0.3971	1.9918
12.9000	0.3974	1.9917
12.9500	0.3977	1.9917
13.0000	0.3979	1.9917
13.0500	0.3982	1.9916
13.1000	0.3985	1.9916
13.1500	0.3987	1.9916
13.2000	0.3990	1.9915

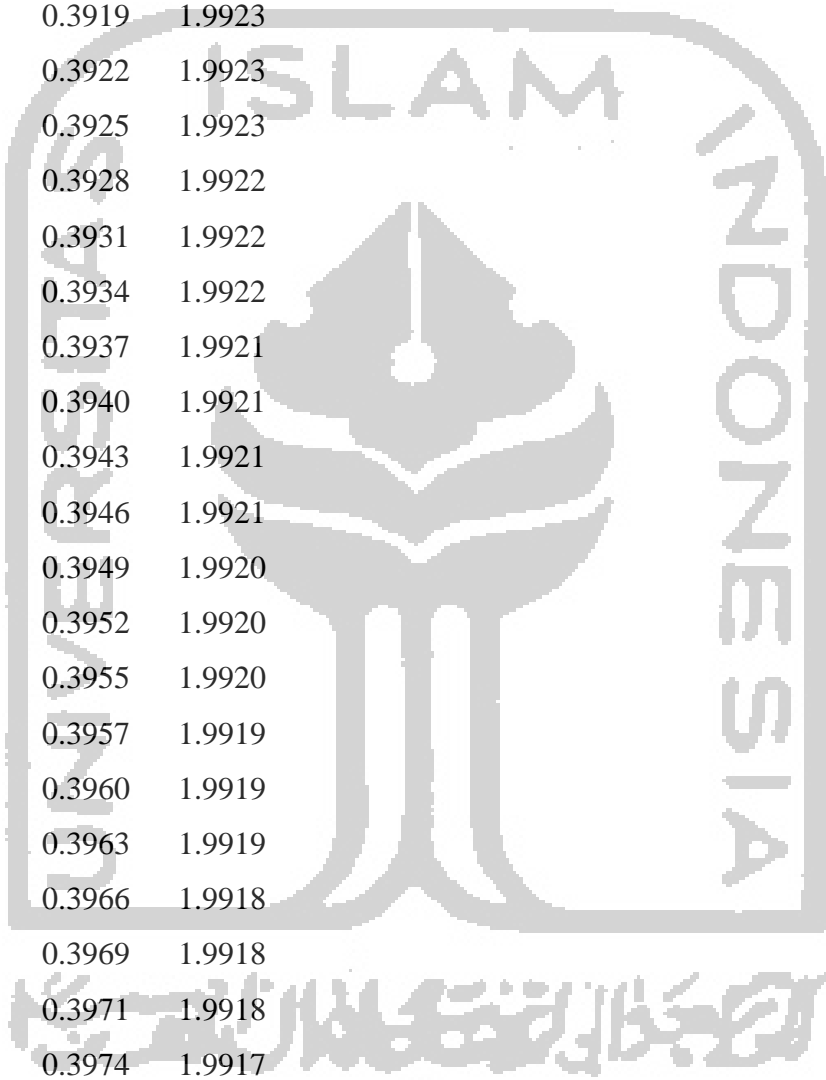

13.2500	0.3993	1.9915
13.3000	0.3995	1.9915
13.3500	0.3998	1.9914
13.4000	0.4000	1.9914
13.4500	0.4003	1.9914
13.5000	0.4005	1.9913
13.5500	0.4008	1.9913
13.6000	0.4010	1.9913
13.6500	0.4013	1.9912
13.7000	0.4015	1.9912
13.7500	0.4017	1.9912
13.8000	0.4020	1.9912
13.8500	0.4022	1.9911
13.9000	0.4024	1.9911
13.9500	0.4027	1.9911
14.0000	0.4029	1.9910
14.0500	0.4031	1.9910
14.1000	0.4034	1.9910
14.1500	0.4036	1.9909
14.2000	0.4038	1.9909
14.2500	0.4040	1.9909
14.3000	0.4043	1.9908
14.3500	0.4045	1.9908
14.4000	0.4047	1.9908
14.4500	0.4049	1.9907
14.5000	0.4051	1.9907
14.5500	0.4054	1.9907
14.6000	0.4056	1.9906
14.6500	0.4058	1.9906
14.7000	0.4060	1.9906
14.7500	0.4062	1.9905
14.8000	0.4064	1.9905

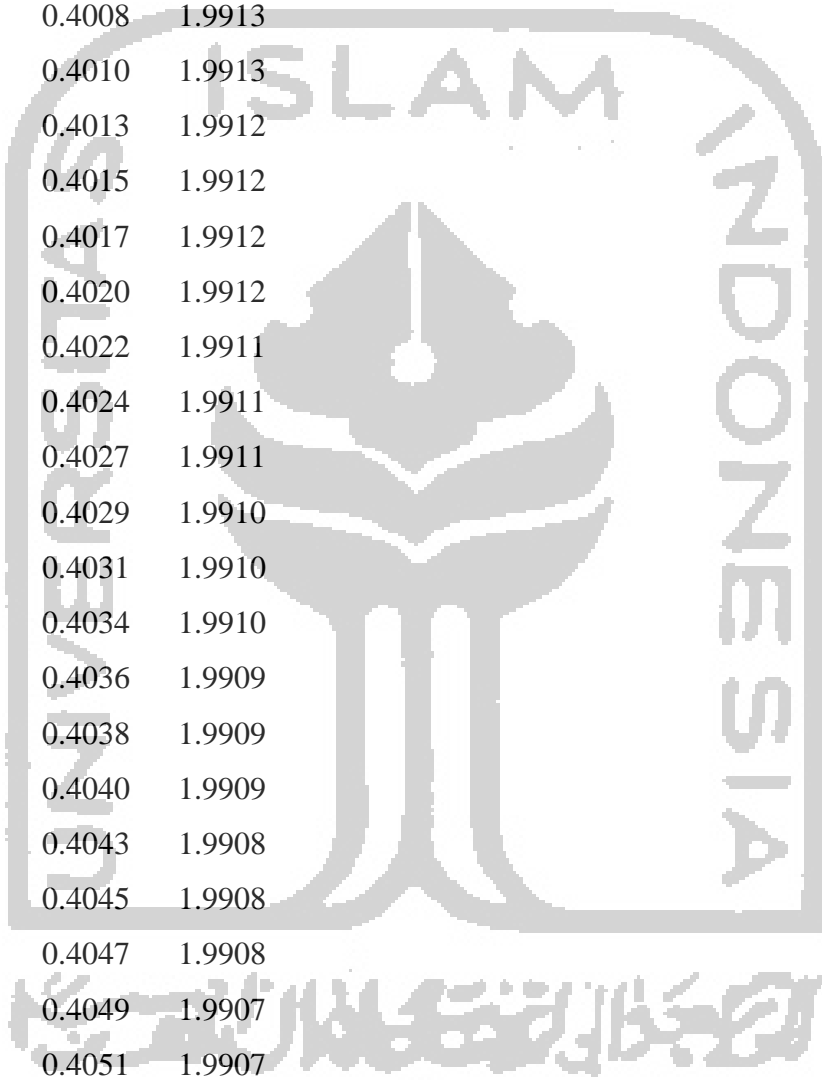

14.8500	0.4066	1.9905
14.9000	0.4068	1.9904
14.9500	0.4070	1.9904

Pada konversi 40%, tinggi tumpukan katalis sebesar 13,4 m.

$$\begin{aligned} \text{Pressure drop} &= 2 \text{ atm} - 1,9914 \text{ atm} \\ &= 0,0086 \text{ atm} \end{aligned}$$

K. Menghitung Tinggi dan Volume Reaktor

1. Tebal Shell (ts)

Tebal *shell* dihitung dengan persamaan berikut :

$$t_s = \frac{P \cdot r_i}{f \cdot E - 0,6 \cdot P} + C \quad (\text{Brownell, persamaan 13.1})$$

t_s : tebal *shell* minimum, in

P : *design pressure*, psi

r_i : jari-jari dalam *shell* (0,5.IDS)

f : *maximum allowable stress* (Tabel 13.1 Brownell), psi

E : efisiensi pengelasan (Tabel 13.2 Brownell)

C : *corrosion allowance*, in

Direncanakan bahan yang digunakan untuk *shell* terbuat dari *Hastelloy R-41* , dengan spesifikasi :

f : 90800 psi

E : 0,8

C : 0,125 in

Faktor keamanan : 50 %

$$P = 2 \text{ atm} \cdot 14,7 \frac{\text{psi}}{\text{atm}} \cdot 150\% = 44,1 \text{ psi}$$

$$r_i = 0,5 \cdot \text{IDS} = 0,5 \cdot 139,678 \text{ in} = 69,839 \text{ in}$$

$$\begin{aligned} t_s &= \frac{44,1 \text{ psi} \cdot 69,839 \text{ in}}{90800 \text{ psi} \cdot 0,8 - 0,6 \cdot 44,1 \text{ psi}} + 0,125 \\ &= 0,1674 \text{ in} \end{aligned}$$

Digunakan tebal *shell* standar 0,1875 in

Diameter luar *shell*:

$$\text{ODS} = \text{IDS} + 2 \text{ ts} = 139,678 \text{ in} + 2 \cdot 0,1875 = 140,0532 \text{ in}$$

Digunakan diameter *shell* standar = 144 in

2. Tebal head (th)

Bahan yang digunakan untuk head sama dengan bahan shell yaitu Hastelloy R-41 dan head yang dipilih berbentuk Torispherical head karena cocok digunakan untuk range tekanan 15-200 psi (Brownell. halaman 83).

Tebal head dapat dihitung dengan persamaan :

$$W = \frac{1}{4} \left(3 + \sqrt{\frac{rc}{icr}} \right)$$

$$th = \frac{P \cdot rc \cdot W}{2 \cdot f \cdot E - 0,2 \cdot P} + C$$

th = tebal *head*, in

rc = *crown radius* = 132 dan icr = 8,75 (*table 5.7 Brownell*)

p = tekanan = 44,1 psi

f = *maximum allowable stress* = 90800 psi

E = *joint efficiency* = 0,8

W = *stress intensification factor*

$$W = \frac{1}{4} \left(3 + \sqrt{\frac{132}{8,75}} \right) = 1,721$$

$$th = \frac{44,1 \cdot 132 \cdot 1,721}{2 \cdot 90800 \cdot 0,8 - 0,2 \cdot 44,1} + 0,125$$

$$= 0,2138 \text{ in}$$

Digunakan tebal *head* standar = 0,25

3. Tinggi head

Berdasarkan *table 5.6 Brownell*, didapatkan sf = 1,5-2,5 (diambil 1,75 in).

Tinggi head(OA) dapat dihitung dengan cara sebagai berikut:

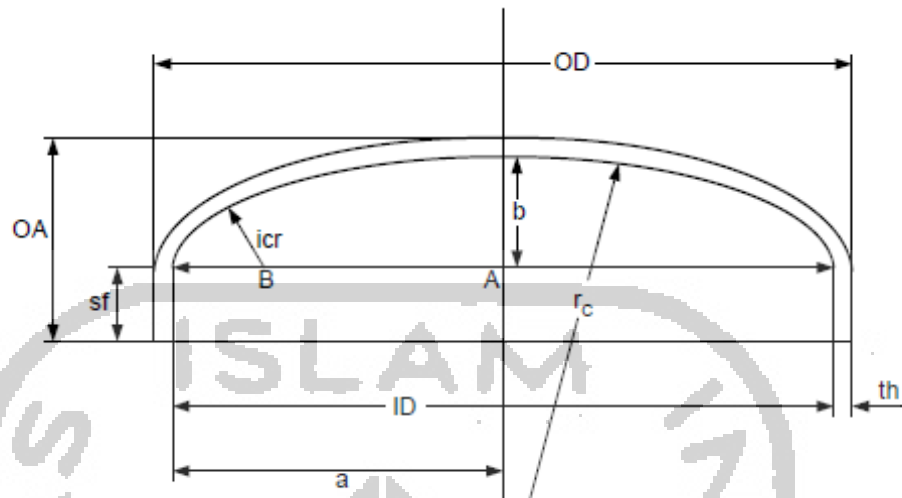

$$a = \text{IDS}/2 = 139,678 \text{ in} / 2 = 69,839 \text{ in}$$

$$AB = a - \text{icr} = 69,839 - 8,75 = 61,089 \text{ in}$$

$$BC = rc - \text{icr} = 132 - 8,75 = 123,25 \text{ in}$$

$$AC = \sqrt{(BC^2 - AB^2)} = \sqrt{(123,25^2 - 61,089^2)} = 107,045 \text{ in}$$

$$b = rc - AC = 132 - 107,045 = 24,955 \text{ in}$$

$$OA \text{ (tinggi head)} = th + b + sf = 0,25 + 24,955 + 1,75 = 26,955 \text{ in} = 0,685 \text{ m}$$

4. Tinggi reaktor

Tinggi reaktor merupakan tinggi *tube* yang digunakan, ditambah 2 kali tinggi head. Tinggi *tube* diperoleh dari hasil pemrograman Scilab.

Tinggi *tube* yang digunakan; $Z = 13,4 \text{ m}$

Tinggi reaktor = $Z + 2 \cdot \text{tinggi head}$

$$= (13,4 + 2 \cdot 0,685) \text{ m}$$

$$= 14,769 \text{ m}$$

5. Volume reaktor

Volume reaktor diperoleh dari volume *shell* ditambah 2 kali volume *head*.

$$\text{Volume head} = 0,000049 \cdot \text{IDS}^3 \quad (\text{Brownell, pers. 5.11})$$

$$= 133,5309 \text{ in}^3$$

$$= 0,0034 \text{ m}^3$$

$$\text{Volume shell} = \frac{\pi}{4} \cdot (IDS)^2 \cdot Z$$

$$= \frac{3,14}{4} \cdot (3,548)^2 \cdot 13,4 = 132,403 \text{ m}^3$$

$$\text{Volume reaktor} = \text{volume shell} + 2 \cdot \text{Volume head}$$

$$= 132,403 + 2 \cdot 0,0034 = 132,4102 \text{ m}^3$$

$$= 34.980,12 \text{ gal}$$

L. Ukuran Pipa

1. Pipa pemasukan Umpan Reaktor :

$$\text{Kecepatan Umpan} = 75166,4 \text{ lb/j}$$

$$\text{Densitas Umpan} = 0,5282 \text{ lb/ft}^3$$

$$Di = 2,2 \cdot (G/1000)^{0,45} \cdot \text{den}^{-0,31}$$

$$= 2,2 \cdot (75166,4 / 1000)^{0,45} \cdot 0,5282^{-0,31}$$

$$= 18,731 \text{ in}$$

Dipakai pipa dengan ukuran : 19 in

2. Pipa pengeluaran hasil Reaktor :

$$\text{Kecepatan hasil} = 75166,4 \text{ lb/j}$$

$$\text{Densitas hasil} = 0,4723 \text{ lb/ft}^3$$

$$Di = 2,2 \cdot (G/1000)^{0,45} \cdot \text{den}^{-0,31}$$

$$= 2,2 \cdot (75166,4 / 1000)^{0,45} \cdot 0,4723^{-0,31}$$

$$= 19,392 \text{ in}$$

Dipakai pipa dengan ukuran : 20 in

M. Isolator

Untuk menjaga kondisi operasi, dinding luar *shell* diberi isolator.

Suhu udara (T_u) = 30 °C = 303 K

Dirancang suhu dinding luar isolator (T_i) = 40 °C = 313 K

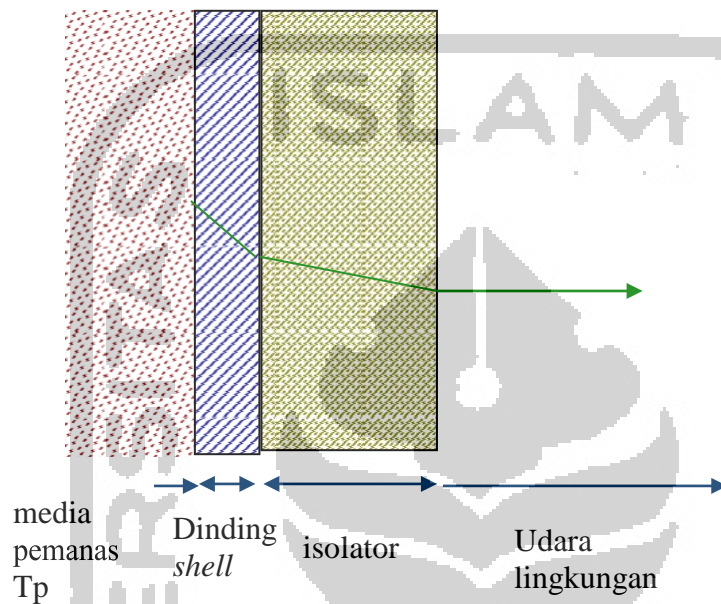

Asumsi: suhu permukaan dinding dalam *shell* = suhu media pemanas

Bahan isolator dipilih *fiber glass*. Perpindahan kalor yang terjadi:

1. Perpindahan kalor secara konduksi pada dinding selongsong mengikuti persamaan:

$$Q = \frac{ks \cdot A \cdot \Delta T}{\Delta x}$$

Dimana : A = Luas perpindahan kalor

$[m^2]$ Q = Kecepatan perpindahan kalor

$[kJ/jam]$ ΔT = beda suhu $[K]$

Bila dinyatakan dalam flux panas :

$$q = \frac{Q}{A} = \frac{ki \cdot \Delta T}{\Delta xi}$$

q = flux panas $[kJ/m^2 \cdot jam]$

flux panas dapat juga dinyatakan dalam bentuk resistansi thermal

$$q = \frac{\Delta T}{R_s}$$

R_s = resistensi thermal secara konduksi [(m².jam.K)/kJ]

$$R_s = \frac{\Delta x}{k_s}$$

2. Perpindahan kalor secara konduksi pada dinding isolator mengikuti persamaan :

$$Q = \frac{k_i \cdot A \cdot \Delta T}{\Delta x_i}$$

Dimana : A = Luas perpindahan kalor [m²]

Q = Kecepatan perpindahan kalor [kJ/jam]

ΔT = beda suhu [K]

Bila dinyatakan dalam flux panas :

$$q = \frac{Q}{A} = \frac{k_i \cdot A \cdot \Delta T}{\Delta x_i}$$

q = flux panas [kJ/m².jam]

flux panas dapat juga dinyatakan dalam bentuk resistansi thermal

$$q = \frac{\Delta T}{R_i}$$

R_s = resistensi thermal secara konduksi [(m².jam.K)/kJ]

$$R_s = \frac{\Delta x}{k_i}$$

3. Perpindahan kalor dari dinding luar isolator ke udara lingkungan

$$q = h_o \cdot (T_3 - T_u)$$

$$h_o = 0,3 \cdot (T_3 - T_u)^{0,25}$$

h_o = koefisien perpindahan kalor

[Btu/(jam.ft².°F)] T_3 dan T_u dinyatakan dalam °F

Bila dinyatakan dalam bentuk resistensi thermal :

$$R_t = \frac{\Delta x}{k_s} + \frac{\Delta x}{k_i} + \frac{1}{h_o}$$

Data yang dipakai :

Konduktivitas thermal steel, $k_s = 21 \text{ Btu}/(\text{jam.ft.}^\circ\text{F})$ (table 3 Kern,DQ)

Konduktivitas thermal aerogel silika, $k_i = 0,013 \text{ Btu}/(\text{jam.ft.}^\circ\text{F})$

Suhu permukaan luar isolator dirancang (T_3) : $40^\circ\text{C} = 104^\circ\text{F}$

Suhu udara lingkungan (T_u) : $30^\circ\text{C} = 86^\circ\text{F}$

$$h_o = 0,3 \cdot (104 - 86)^{0,25}$$

$$h_o = 0,61793 \text{ Btu}/(\text{jam.ft}^2 \cdot ^\circ\text{F})$$

$$q = 0,61793 \text{ Btu}/(\text{jam.ft}^2 \cdot ^\circ\text{F}) \cdot (104 - 86)^\circ\text{F}$$

$$q = 11,12274$$

$$\text{Btu}/(\text{jam.ft}^2) \Delta x_s =$$

$$0,0156 \text{ ft}$$

Dimasukkan ke persamaan perpindahan kalor, menjadi :

$$\frac{T_u - T_3}{\frac{\Delta x_s}{k_s} + \frac{\Delta x_i}{k_i}} = q \frac{\text{Btu}}{\text{jam} \cdot \text{ft}^2}$$

Nilai Δx_i dapat diperoleh :

$$\left(\frac{T_u - T_3}{q} - \frac{\Delta x_s}{k_s} \right) = \Delta x_i$$

$$\Delta x_i = \left(\frac{86 - 104}{11,12274} - \frac{0,0156}{21} \right) \cdot 0,013 = 0,021 \text{ ft} = 0,252 \text{ in}$$

Digunakan tebal isolasi = $3/8 \text{ in}$

KESIMPULAN REAKTOR (R-01)

Fungsi : tempat berlangsungnya reaksi dehidrogenasi propana(C_3H_8)
menghasilkan propilen (C_3H_6)

Jenis : *Multitube fixedbed reactor*

Kondisi operasi : - $T = 600^\circ C$
- $P = 1520 \text{ mmHg (2 atm)}$
- non adiabatik, isothermal

Katalis : Al_2O_3 (padat)

Bahan : *Hastelloy R-41*

Diameter : 3,55 m

Tinggi reaktor : 14,77 m

Panjang *tube* : 13,4 m

Jumlah *tube* : 2000

Tebal *shell* : 0,1875 in

Tebal *head* : 0,25 in

Tinggi *head* : 26,955 in

Volume reaktor : $132,41 \text{ m}^3$

Pemanas

Bahan : NaK

Suhu masuk : $727^\circ C$

Suhu keluar : $692^\circ C$

Jumlah reaktor : 1

Lampiran B (Kartu Konsultasi)

KARTU KONSULTASI BIMBINGAN PRARANCANGAN

1. Nama Mahasiswa : Nailis Sa'adah
 No. MHS : 15521123

2. Nama Mahasiswa : Sarah Anisa Ramadhani
 No. MHS : 15521258

Judul Prarancangan)* : PRA RANCANGAN PABRIK PROSESIN DADI PRO PANJA
 KAPASITAS PRODUKSI 250.000 TON/TAHUN

Mulai Masa Bimbingan : 05 Oktober 2019

Batas Akhir Bimbingan : 02 April 2020

No	Tanggal	Materi Bimbingan	Paraf Dosen
1	12 April 2019	Konsultasi judul, skripsi	A
2	20 April 2019	penyusunan kapasitas produksi	A
3	8 Mei 2019	penyusunan BAB I dan BAB II	A
4	20 Mei 2019	Revisi dan diskusi BAB I dan BAB II	A
5	15 Agsr 2019	penyusunan BAB III, BAB IV dan V	A
6	15 September 19	Revisi dan diskusi BAB III, BAB IV dan V	A
7	16 Okt 2019	Konsultasi REF.	A
8	13 Nov 2019	Konsultasi Naskah Akhir	A

Disetujui Draft Penulisan:

Yogyakarta, 13 NOVEMBER 2019

Pembimbing,

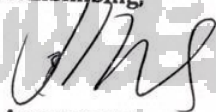

Asmanto Subagyo, M.Sc.

)* Judul PraRancangan Ditulis dengan Huruf Balok

- Kartu Konsultasi Bimbingan dilampirkan pada Laporan PraRancangan
- Kartu Konsultasi Bimbingan dapat difotocopy



Scanned with
CamScanner

KARTU KONSULTASI BIMBINGAN PRARANCANGAN

1. Nama Mahasiswa : Nailis Sa'adah
 No. MHS : 15521123
2. Nama Mahasiswa : Sarah Anisa Ramadhani
 No. MHS : 15521258
- Judul Prarancangan)* : **PRARANCANGAN PABRIK PROPILIN DARI PROPANA
 KAPASITAS PRODUKSI 250.000 TON / TAHUN**

Mulai Masa Bimbingan : 05 Oktober 2019

Batas Akhir Bimbingan : 02 April 2020

No	Tanggal	Materi Bimbingan	Paraf Dosen
1	12 April 2019	Konsultasi judul	Ifa
2	20 April 2019	Menentukan kapasitas	Ifa
3	8 Mei 19	Menghitung Neraca Massa & Neraca panas	Ifa
4	20 Mei 19	Revisi dan diskusi perhitungan	Ifa
5	15 Agsts 19	Menyusun BAB I dan BAB II	Ifa
6	15 Sept 19	Menyusun BAB III, IV dan V	Ifa
7	16 Okt 19	KONSULTASI PEPD	Ifa
8	12 NOV 19	Revisi dan konsultasi Naskah Final	Ifa

Disetujui Draft Penulisan:

Yogyakarta, 12 November 2019

Pembimbing

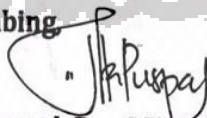

Ifa Puspasari, Dr., S.T., M.Eng.

Judul PraRancangan Ditulis dengan Huruf Balok

 Kartu Konsultasi Bimbingan dilampirkan pada Laporan PraRancangan
 Kartu Konsultasi Bimbingan dapat difotocopy

PROCESS ENGINEERING FLOW DIAGRAM PRA RANCANGAN PABRIK PROPILEN DARI PROPANA KAPASITAS 250.000 TON/TAHUN

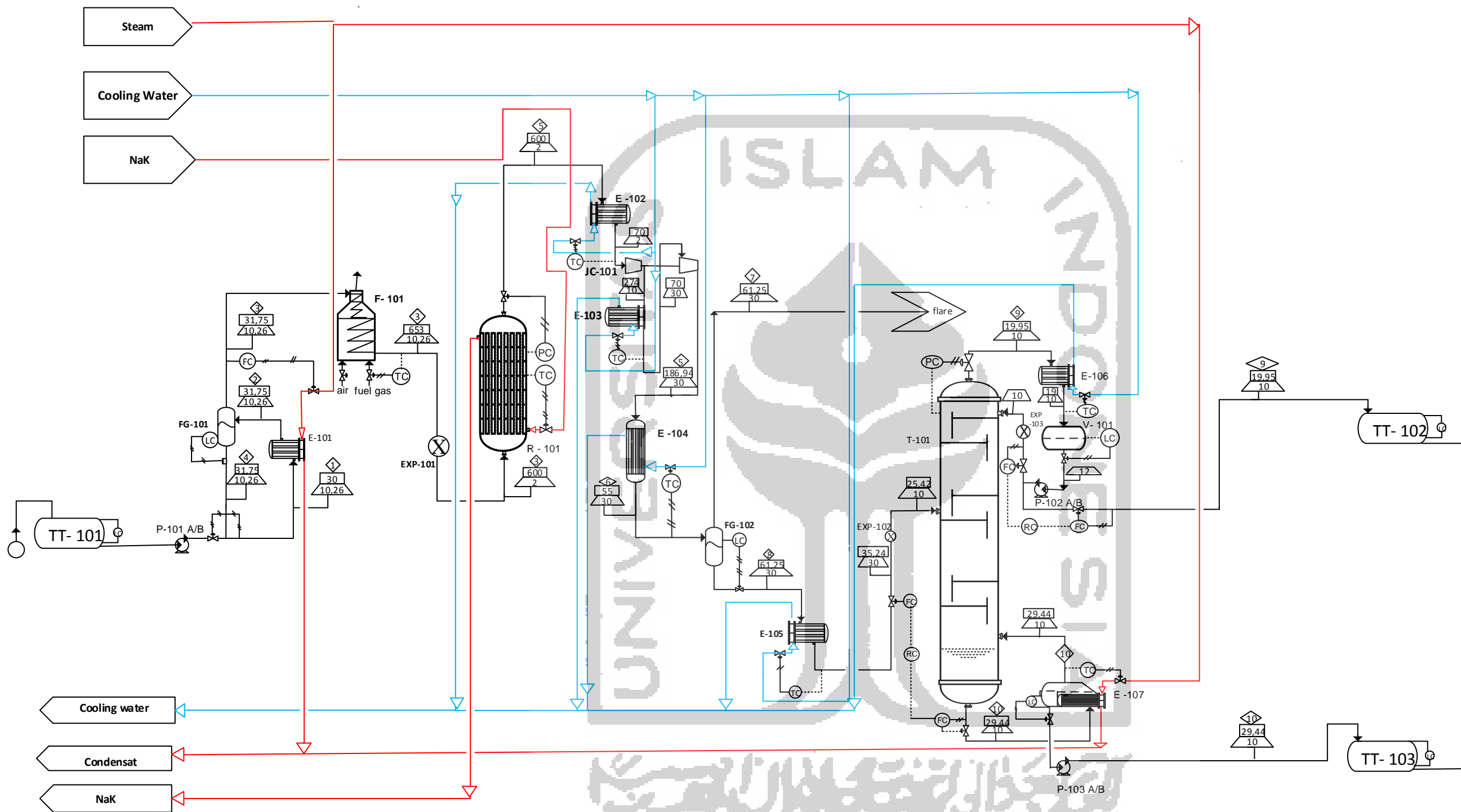

KOMPONEN	NOMOR ARUS (kg/jam)									
	1	2	3	4	5	6	7	8	9	10
Hidrogen	0	0	0	0	1554	777	1554	0	0	0
Propilen	855	1068	855	214	33492	33492	2009	31482	31325	157
Propana	85477	106846	85477	21369	51286	51286	3077	48209	241	47968
n- Butana	4274	5342	4274	1068	4274	4274	256	4017	0	4017
total	90606	113257	90606	22651	90606	89829	6897	83709	31566	52143

ALAT	KETERANGAN
V	Vessel
E	Heat Exchanger
FG	Separator
T	Tower
R	Reactor
P	Pump
JC	Compressor
F	Furnace
EXP	Expansion Valve

SIMBOL	KETERANGAN
FC	Flow Control
LC	Level Control
PC	Pressure Control
TC	Temperature Control
RC	Ratio Control
◇	Nomor Arus
△	Suhu, °C
▽	Tekanan, atm
---	Electric Connection
—	Piping
	Udara tekan
⊥	Control Valve



UNIVERSITAS ISLAM INDONESIA

JURUSAN TEKNIK KIMIA
FAKULTAS TEKNOLOGI INDUSTRI
UNIVERSITAS ISLAM INDONESIA
YOGYAKARTA

PROCESS ENGINEERING FLOW DIAGRAM
PRA RANCANGAN PABRIK PROPILEN DARI PROPANA
KAPASITAS 250.000 TON/TAHUN

Dikerjakan Oleh :

1. Nailis Sa'adah (15521123)
2. Sarah Anisa Ramadhani (15521258)

Dosen Pembimbing :

1. Asmanto Subagyo, M.Sc.
2. Dr. Iffa Puspasari, S.T., M.Eng.