

**LEMBAR PENGESAHAN
TUGAS AKHIR**

**ANALISIS RENCANA ANGGARAN BIAYA PADA
KONSTRUKSI GEDUNG DENGAN
METODA NON BOW**

**Diajukan kepada Universitas Islam Indonesia
untuk memenuhi sebagian persyaratan memperoleh
Derajat Sarjana Teknik Sipil**

Disusun Oleh :

WORO PALUPI ADHADI ASTUTI

No. Mhs : 98 511 291

Telah diperiksa dan disetujui oleh :

Dosen Pembimbing I,



Ir. H. TADJUDDIN BMA, MT.

Tanggal : 10/7-04

KATA PENGANTAR



Assalamu'alaikum Wr. Wb.

Dengan memanjatkan puji syukur kehadiran Allah SWT yang telah melimpahkan karunia dan rahmat-Nya, serta salam dan salawat kepada junjungan kita Nabi Muhammad SAW, sehingga penyusun dapat menyelesaikan Tugas Akhir ini dengan baik. Tugas Akhir ini disusun sebagai syarat untuk memperoleh jenjang pendidikan Strata Satu (S-1) pada Jurusan Teknik Sipil, Fakultas Teknik Sipil dan Perencanaan, Universitas Islam Indonesia (UII), Yogyakarta.

Pada Tugas Akhir ini penyusun mengambil judul "ANALISIS RENCANA ANGGARAN BIAYA PADA KONSTRUKSI GEDUNG DENGAN METODA NON B.O.W " .

Selama pengerjaan dan penyusunan Tugas Akhir ini, tentunya penyusun tidak lepas dari segala hambatan dan kesulitan, tetapi atas bantuan, petunjuk, dan bimbingan serta masukan-masukan yang berharga dari berbagai pihak, akhirnya segala hambatan dan kesulitan dapat teratasi. Oleh karena itu, pada kesempatan ini perkenankanlah penyusun untuk menyampaikan ucapan terima kasih yang sebesar-besarnya kepada :

1. Bapak Prof. Ir. H. Widodo, MSCE, Ph.D, selaku Dekan Fakultas Teknik Sipil dan Perencanaan, Universitas Islam Indonesia, Yogyakarta.

2. Bapak Ir. H. Munadhir, MS, selaku Ketua Jurusan Teknik Sipil, Fakultas Teknik Sipil dan Perencanaan, Universitas Islam Indonesia, Yogyakarta.
3. Bapak Ir. H. Tadjuddin BMA, MT, selaku Dosen Pembimbing I dan Dosen Penguji Tugas Akhir, yang telah banyak memberikan bimbingan dan arahan kepada penyusun.
4. Ibu Ir. Hj. Tuti Sumarningsih, ST, MT selaku Dosen Penguji.
5. Ibu Fitri Nugraheni, ST, MT selaku Dosen Penguji.
6. Seluruh pihak perencana Proyek Pembangunan Masjid Kampus UMY, Yogyakarta, yang telah memberikan informasi dan data yang dibutuhkan dalam penyusunan Tugas Akhir ini.
7. Seluruh rekan-rekan yang tidak dapat penyusun sebutkan satu persatu.

Semoga seluruh amal dan kebaikan yang diberikan dapat diterima dan mendapatkan ridho dari Allah SWT.

Penyusun menyadari bahwa dalam penyusunan Tugas Akhir ini belum dapat dikatakan sempurna karena masih terdapat banyak kekurangan dan kesalahan. Oleh karena itu, dalam kesempatan ini penyusun mengharapkan saran dan kritik yang bersifat membangun demi kesempurnaan laporan Tugas Akhir ini. Penyusun berharap semoga laporan ini dapat bermanfaat bagi kita semua.

Wassalamu'alaikum Wr. Wb.

Yogyakarta, Juli 2004

Penyusun

Motto in my life

"Hai orang-orang beriman, mintalah pertolongan dari Allah dengan kesabaran dan sholat. (Al Baqoroh : 153)

"..... Allah meninggikan orang-orang yang beriman dan berpengetahuan diantaramu dan beberapa derajat lebih tinggi ".
(al mujadillah : 11)

"Jangan kamu memalingkan mukamu dari seseorang dan jangan berjalan di bumi ini dengan angkuh. Sesungguhnya Allah tidak suka dengan orang-orang yang sombong dan bangga diri". (Luqman : 18)

"Tuntutlah ilmu dari dalam ayunan hingga sampai ke liang lahat".
(HR; Buchori Muslim)

"Agama tanpa ilmu buta , ilmu tanpa agama lumpuh"

"Ora et labora , terus berusaha dan terus berdoa dan bersyukur, kelak suatu kesuksesan tidak akan membuat kita buta dan lupa karena kesuksesan bukanlah suatu keberhasilan , melainkan kesuksesan adalah sedikit diatas rata-rata" (upie'smartgirl)

ABSTRAK

Langkah awal dalam proses pembangunan suatu proyek adalah memperkirakan estimasi biaya optimal yang dapat dipertanggungjawabkan. Estimasi biaya atau Rencana Anggaran Biaya (RAB) adalah perkiraan biaya-biaya yang diperlukan untuk tiap pekerjaan dalam suatu proyek, sehingga diperoleh biaya total untuk menyelesaikan proyek tersebut.

Salah satu metoda perhitungan anggaran biaya adalah dengan metode Non BOW. Prinsip dasar pada metoda Non BOW adalah analisis koefisien bahan berdasarkan gambar rencana, sedangkan harga upah yang diperhitungkan merupakan upah borongan.

Hitungan Rencana Anggaran Biaya (RAB) suatu proyek berpedoman pada gambar rencana. Untuk mendapatkan biaya yang efisien maka diperlukan pemanfaatan material yang efektif. Misalkan pada pekerjaan bekisting diharapkan pemakaian bahan sedapat mungkin menggunakan bahan yang dapat dimanfaatkan lagi untuk mengurangi anggaran biaya

Dari hasil perhitungan diperoleh Rencana Anggaran Biaya pada pekerjaan struktural proyek adalah Rp. 3.293.752.443,37. Prosentase penurunan biaya pada pekerjaan kolom lantai 1 ke lantai 2 rata-rata sebesar 6,18 % dan kolom lantai 2 ke lantai 3 sebesar 3,52 %, penurunan ini dikarenakan adanya pengurangan penggunaan material tiap lantai. Prosentase kenaikan biaya pada pekerjaan balok lantai 2 ke lantai 3 rata-rata sebesar 4 % dan lantai 3 ke lantai atap sebesar 4,64 %. Prosentase kenaikan biaya pada pekerjaan pelat lantai 2 ke lantai 3 rata-rata sebesar 3,06 % dan pada pelat lantai 3 ke lantai atap mengalami penurunan biaya sebesar 2,33 %.

DAFTAR ISI

HALAMAN JUDUL.....	i
HALAMAN PENGESAHAN.....	ii
KATA PENGANTAR.....	iii
ABSTRAK.....	v
DAFTAR ISI.....	vi
DAFTAR GAMBAR.....	ix
DAFTAR TABEL.....	x
DAFTAR LAMPIRAN.....	xi
BAB I PENDAHULUAN	
1.1. Latar Belakang Masalah.....	1
1.2. Rumusan Masalah.....	3
1.3. Tujuan Penelitian.....	4
1.4. Batasan Masalah.....	4
1.5. Manfaat Penelitian.....	5
BAB II TINJAUAN PUSTAKA	
2.1. Hasil Penelitian yang Pernah Dilakukan.....	6
2.2. Beberapa Literatur yang Menunjang penelitian.....	7
BAB III LANDASAN TEORI	
3.1. Rencana Anggaran Biaya.....	9
3.1.1. Definisi.....	9
3.1.2. Tujuan Penyusunan RAB.....	10

3.1.3. Data yang Diperlukan Dalam Pembuatan RAB	11
3.1.4. Harga Satuan Pekerjaan.....	13
3.2. Metoda Perhitungan	14
3.3. Analisa Anggaran Biaya BOW	15
3.4. Analisa Anggaran Biaya Non BOW (Praktis)	17
3.5. Pelaksanaan Pekerjaan Konstruksi.....	19
3.5.1. Pekerjaan Struktur Pondasi.....	19
3.5.2. Pekerjaan Beton.....	20
3.5.3. Bekisting.....	20
3.5.4. Campuran Beton.....	21
3.5.5. Penulangan.....	22
3.5.6. Scaffolding / Perancah.....	23
3.5.7. Pekerjaan Pasangan Batako.....	26
 BAB IV METODE PENELITIAN	
4.1. Subjek Penelitian.....	27
4.2. Objek Penelitian.....	27
4.3. Data yang Diperlukan	27
4.4. Cara Pengumpulan Data.....	28
4.5. Pengolahan Data.....	28
 BAB V ANALISIS HARGA TIAP PEKERJAAN	
5.1. Rencana Pekerjaan	31

5.2. Analisis Harga Tiap Pekerjaan dengan	
Metoda Non BOW.....	32
5.2.1. Pekerjaan Urugan.....	32
5.2.2. Pekerjaan Tiang Pancang.....	33
5.2.3. Pekerjaan Lantai Kerja di Bawah Poer	
dan di Bawah Sloof Tebal 10 cm.....	34
5.2.4. Pekerjaan Beton Poer Pile	38
5.2.5. Pekerjaan Beton Balok Sloof.....	46
5.2.6. Pekerjaan Beton Kolom.....	54
5.2.7. Pekerjaan Beton Balok Lantai	92
5.2.8. Pekerjaan Beton Pelat Lantai.....	104
5.2.9. Pekerjaan Beton Ring Balk.....	111
5.3. Rekap Anggaran Biaya.....	122
BAB VI PEMBAHASAN.....	123
BAB VII KESIMPULAN DAN SARAN	
7.1. Kesimpulan.....	132
7.2. Saran-saran.....	134
DAFTAR PUSTAKA	135

DAFTAR GAMBAR

Gambar 3.1	Bagan Perhitungan Anggaran Biaya	13
Gambar 3.2	Bagan Harga Satuan Pekerjaan	14
Gambar 3.3	Skema Perhitungan RAB dengan Metoda BOW	16
Gambar 3.4	Skema Perhitungan RAB dengan Metode Non BOW (Praktis).....	18
Gambar 3.5	Scaffolding	25
Gambar 4.1	Bagan Alir Penelitian	30

DAFTAR TABEL

Tabel 3.1	Daftar Harga Bahan/Material untuk Pekerjaan Pondasi	19
Tabel 3.2	Daftar Harga Bahan/Material untuk Pekerjaan Bekisting.....	21
Tabel 3.3	Daftar Harga Bahan/Material untuk Pekerjaan Campuran Beton.....	22
Tabel 3.4	Diameter dan Berat Besi	22
Tabel 3.5	Daftar Harga Bahan/Material untuk Pekerjaan Penulangan	23
Tabel 3.6	Daftar Harga Sewa Peralatan Scaffolding.....	24
Tabel 3.7	Kebutuhan Spesi/Lepa	26
Tabel 3.8	Komposisi Kandungan Udara dan Air	26
Tabel 5.1	Jenis Pekerjaan dan Volume Pekerjaan.....	31
Tabel 5.2	Perhitungan Volume Beton Lantai Kerja di bawah Poer Pile.....	34
Tabel 5.3	Perhitungan Volume Beton Lantai Kerja di bawah Sloof.....	34
Tabel 5.4	Harga Satuan Pekerjaan Lantai Kerja	37
Tabel 5.5	Harga Satuan Pekerjaan Poer Pile Tipe 2	45
Tabel 5.6	Harga Satuan Pekerjaan Balok Sloof Tipe S1.....	53
Tabel 5.7	Harga Satuan Pekerjaan Kolom Lantai 1 Tipe K1.....	62
Tabel 5.8	Harga Satuan Pekerjaan Kolom Lantai 1 Tipe K3.....	77
Tabel 5.9	Harga Satuan Pekerjaan Kolom Lantai 1 Tipe KL1	91
Tabel 5.10	Harga Satuan Pekerjaan Balok Lantai 2 Tipe G1	103
Tabel 5.11	Harga Satuan Pekerjaan Pelat Lantai 2 Tipe P1.....	109
Tabel 5.12	Harga Satuan Pekerjaan Ring Balk.....	120

DAFTAR LAMPIRAN

- Lampiran 1. Lembar Konsultasi Tugas Akhir.
- Lampiran 2. Surat Bimbingan Tugas Akhir.
- Lampiran 3. Surat Permohonan Data.
- Lampiran 4. Perhitungan Pekerjaan Poer Pile.
- Lampiran 5. Perhitungan Pekerjaan Balok Sloof.
- Lampiran 6. Perhitungan Pekerjaan Kolom.
- Lampiran 7. Perhitungan Pekerjaan Balok Lantai.
- Lampiran 8. Perhitungan Pekerjaan Pelat Lantai.
- Lampiran 9. Perhitungan Pekerjaan Ring Balk.
- Lampiran 10. Harga Satuan Upah Borongan Pekerjaan.
- Lampiran 11. Gambar Rencana

BAB I

PENDAHULUAN

1.1 Latar Belakang Masalah

Pembangunan nasional dilaksanakan dalam rangka membangun manusia Indonesia seutuhnya, juga pembangunan nasional menghendaki keselarasan dan keseimbangan antara pemerintah daerah dan pemerintah pusat. Sehingga tidak ada kesan bahwa pembangunan hanya dimiliki oleh masyarakat perkotaan saja, namun juga dirasakan oleh semua lapisan masyarakat di seluruh tanah air. Pembangunan nasional berarti pembangunan secara fisik maupun non fisik. Pembangunan secara fisik dilihat dari pembangunan fasilitas atau sarana prasarana suatu daerah, yang merupakan bentuk nyata seperti pembangunan jalan, pembangunan rumah sakit, dan pembangunan gedung. Sementara pembangunan non fisik berupa peningkatan kualitas sumberdaya manusia.

Pembangunan yang sedang giat dilaksanakan dewasa ini, khususnya di Yogyakarta, dititik beratkan pada pembangunan fisik serta pengembangan sumber daya manusia. Yogyakarta merupakan kota pusat kegiatan dan aktifitas berbagai bidang, khususnya bidang budaya dan pendidikan. Seiring dengan hal ini, Universitas Muhammadiyah Yogyakarta (UMY) sebagai salah satu institusi pendidikan yang sedang berkembang, membangun kampus terpadu sehingga

semua fakultas yang ada berada dalam satu lingkup kawasan, serta membangun gedung-gedung yang mendukung untuk memberikan fasilitas dan kenyamanan terhadap aktifitas di lingkungan Universitas Muhammadiyah Yogyakarta (UMY).

Dalam hal ini pembangunan masjid kampus Universitas Muhammadiyah Yogyakarta tidak dapat dielakkan lagi sebagai konsekuensi terhadap pembangunan kampus terpadu Universitas Muhammadiyah Yogyakarta. Dalam fungsinya sebagai tempat peribadatan guna menunjang kegiatan-kegiatan keagamaan dan juga kegiatan-kegiatan yang lainnya diluar kegiatan keagamaan dengan tersedianya fasilitas-fasilitas yang menunjang kegiatan tersebut seperti tersedianya auditorium atau ruang serba guna dan ruang untuk lembaga -- lembaga mahasiswa yang bersifat kerohanian.

Langkah awal dalam proses pembangunan suatu proyek adalah memperkirakan estimasi biaya optimal yang dapat dipertanggungjawabkan. Estimasi biaya atau Rencana Anggaran Biaya (RAB) adalah perkiraan biaya-biaya yang diperlukan untuk tiap pekerjaan dalam suatu proyek, sehingga diperoleh biaya total yang diperlukan untuk menyelesaikan proyek tersebut. Maksud pembuatan RAB ini antara lain sebagai alat bantu untuk untuk menentukan biaya investasi modal yang dibutuhkan, mengatur arus pembiayaan dan menentukan tingkat kelayakan suatu rancangan.

Dengan kondisi ekonomi negara yang sedang dilanda krisis ekonomi yang berkepanjangan, secara langsung maupun tidak langsung berpengaruh terhadap harga bahan atau material dan upah pekerja. Oleh sebab itu dalam setiap

pembangunan yang sedang berjalan diperlukan manajemen yang baik terutama bila pembangunan tersebut berskala besar.

Demikian juga dalam pembangunan masjid kampus UMY, diperlukan manajemen yang baik. Untuk mengantisipasi permasalahan ini, Tugas Akhir ini mengambil topik tentang perencanaan anggaran biaya pada proyek pembangunan masjid kampus UMY, yaitu perhitungan Rencana Anggaran Biaya pada pekerjaan struktural proyek dengan menggunakan metode Non BOW. Perhitungan volume berdasarkan pada gambar rencana dan untuk harga satuan pekerjaan yaitu harga material dan harga upah borongan mengacu pada harga yang berlaku di daerah setempat. Dengan penelitian ini diharapkan agar ilmu yang di dapat dari bangku kuliah dapat diterapkan untuk membuat perhitungan Rencana Anggaran Biaya (RAB) sebagai bekal mempersiapkan diri dalam dunia konstruksi yang sebenarnya.

1.2 Rumusan Masalah

Dalam penyusunan tugas akhir ini yang menjadi rumusan masalah adalah bagaimana merencanakan anggaran biaya yang dihitung dengan teliti, cermat dan memenuhi syarat. Rencana Anggaran Biaya dibuat sebelum proyek dilaksanakan, jadi masih merupakan anggaran biaya perkiraan, bukan anggaran biaya yang sebenarnya berdasarkan pelaksanaan (*actual cost*). Metoda yang digunakan dalam perhitungan anggaran biaya adalah metoda Non BOW. Prinsip dasar pada metoda Non BOW adalah analisis koefisien bahan berdasarkan gambar rencana, sedangkan harga upah yang diperhitungkan merupakan upah borongan.

1.3 Tujuan Penelitian

Tujuan penelitian ini adalah untuk menghitung Rencana Anggaran Biaya (RAB) pada proyek pembangunan masjid khususnya rencana anggaran biaya pada pekerjaan struktural proyek dengan menggunakan metoda Non BOW dan untuk menganalisa perhitungan volume pekerjaan dihitung sesuai dengan gambar rencana yang telah dibuat oleh perencana proyek

1.4 Batasan Masalah

Agar penulisan Tugas Akhir ini lebih terarah dan mudah dipahami sesuai dengan tujuan pembahasan serta untuk memperjelas ruang lingkup permasalahan perlu dilakukan pembatasan masalah.

Batasan-batasan itu adalah:

1. penelitian dilakukan pada proyek pembangunan masjid kampus Universitas Muhammadiyah Yogyakarta,
2. perhitungan hanya dilakukan pada pekerjaan struktural,
3. alat Bantu olah data digunakan program *Microsoft Excel*,
4. data volume pekerjaan dihitung berdasarkan gambar rencana,
5. bahan bangunan yang digunakan adalah bahan yang sesuai dengan Rencana Kerja Syarat - syarat (RKS),
6. biaya langsung yang diperhitungkan adalah biaya bahan dan upah tenaga kerja,
7. biaya tidak langsung seperti biaya *overhead* dan gaji karyawan tidak diperhitungkan,

8. harga satuan bahan bangunan dan harga upah borongan pekerja yang digunakan adalah harga yang berlaku pada saat penyusunan Tugas Akhir.

1.5 Manfaat Penelitian

Dari penelitian Tugas Akhir ini dapat diambil manfaat, yaitu sebagai masukan kepada pihak perencana proyek dalam penyusunan Rencana Anggaran Biaya (RAB) pada proyek berikutnya khususnya pada pekerjaan struktural dan juga diharapkan sebagai pengalaman bagi penyusun. Diharapkan juga dapat memberikan manfaat sebagai bahan acuan bacaan dan referensi bagi komunitas akademik.

BAB II

TINJAUAN PUSTAKA

Untuk menghindari duplikasi dalam pengerjaan tugas akhir ini penulis memaparkan hasil penelitian dari tugas akhir yang pernah dilakukan dan literatur yang menunjang penyusunan dan dijadikan sebagai acuan seperti yang dijelaskan sebagai berikut ini.

2.1 Hasil Penelitian yang Pernah Dilakukan

Sebagai bahan perbandingan dan bahan referensi untuk penelitian kami, maka memaparkan hasil penelitian yang sudah dilaksanakan guna menghindari duplikasi. Hasil penelitian yang telah dilakukan sebagai berikut:

1. Deny Hermawan (2002)

Penelitian yang dilakukan oleh Deny Hermawan (2002) tentang Studi Analisa RAB Pada Konstruksi Gedung Dengan metode B.O.W. dan Non B.O.W. (Proyek Pembangunan Gedung Registrasi UII Yogyakarta). Dari hasil penelitian tersebut diperoleh hasil bahwa dengan metoda B.O.W secara murni (tanpa modifikasi) menghasilkan harga upah dan harga satuan pekerjaan yang cenderung lebih mahal dan biaya proyek yang terlalu besar, dibandingkan dengan metoda Non B.O.W (praktis), yang menghasilkan harga satuan material dan harga satuan

pekerjaan yang cenderung lebih murah, kecuali pada pekerjaan cetakan kolom K2 dengan 105,92% untuk metoda praktis dan 100% untuk metoda B.O.W,

2. Puteri Paramita (2003)

Penelitian yang telah dilakukan oleh Puteri Paramita (2003) tentang Studi Analisa Biaya Pelaksanaan Pekerjaan Struktur Pada Konstruksi Gedung Bertingkat (Proyek Pembangunan Gedung kampus UPN “Veteran” Yogyakarta). Dari hasil penelitian tersebut diperoleh total biaya untuk pelaksanaan pekerjaan struktural pada Proyek Pembangunan Gedung Kampus Babarsari UPN “Veteran” Babarsari Yogyakarta tahap 2 adalah Rp 1.030.648.525,00, dan untuk rata-rata kenaikan biaya upah untuk tiap lantai adalah 9.8 %, untuk biaya sewa alat mengalami penurunan karena penggunaan alat dari pekerjaan di lantai bawahnya dapat dipergunakan lagi untuk lantai selanjutnya, dan prosentase rata-rata kenaikan biaya upah dan alat pada pekerjaan balok sebesar 4%.

2.2 Beberapa Literatur yang Menunjang Penelitian

Dasar dari penelitian yang kami lakukan tidak lepas dari literatur- literatur yang sudah ada mengenai manajemen konstruksi. Literatur-literatur yang menunjang penelitian adalah seperti yang dimaksud berikut ini.

1. Iman Socharto (1997)

Perkiraan biaya memegang peranan penting dalam penyelenggaraan proyek. Pada taraf pertama dipergunakan untuk mengetahui berapa besar biaya yang diperlukan untuk membangun proyek atau investasi, selanjutnya memiliki

fungsi dengan spektrum yang amat luas yaitu merencanakan dan mengendalikan sumber daya seperti material, tenaga kerja, pelayanan maupun waktu. Meskipun kegunaannya sama, namun untuk masing-masing organisasi peserta proyek penekanannya berbeda-beda. Bagi pemilik, angka yang menunjukkan jumlah perkiraan biaya yang akan menjadi salah satu patokan untuk menentukan kelanjutan investasi. Untuk kontraktor, keuntungan finansial yang akan diperoleh tergantung kepada seberapa jauh kecakapannya membuat perkiraan biaya. Bila penawaran harga yang diajukan didalam proses lelang terlalu tinggi, kemungkinan besar kontraktor yang bersangkutan akan mengalami kekalahan. Sebaliknya bila memenangkan lelang dengan harga yang terlalu rendah, akan mengalami kesulitan belakang hari. Sedangkan untuk konsultan, angka tersebut diajukan kepada pemilik sebagai usulan jumlah biaya terbaik untuk berbagai kegunaan sesuai perkembangan proyek dan sampai drajat tertentu, kredibilitasnya terkait dengan kebenaran atau ketepatan angka-angka yang diusulkan.

2. Soedrajat Sastraatmadja (1984)

Penaksiran anggaran biaya adalah proses perhitungan volume pekerjaan harga dari berbagai macam bahan dan pekerjaan yang terjadi pada suatu konstruksi. Karena taksiran dibuat sebelum pembangunan dimulai, maka jumlah biaya yang diperoleh ialah "taksiran biaya" bukan "biaya sebenarnya" atau *actual cost*. Layak atau tidak suatu taksiran biaya dengan biaya sebenarnya, tergantung dari kepandaian dan keputusan yang diambil berdasarkan pengalaman.

BAB III

LANDASAN TEORI

3.1 Rencana Anggaran Biaya

3.1.1 Definisi

Menurut John W. Niron dalam bukunya Pedoman Praktis Anggaran dan Borongan (Rencana Anggaran Biaya Bangunan), 1990, definisi Rencana Anggaran Biaya (RAB) adalah sebagai berikut:

Rencana : Himpunan planning termasuk detail/penjelasan dan tata cara pelaksanaan pembuatan sebuah bangunan

Anggaran : Perkiraan/perhitungan biaya suatu bangunan berdasarkan bestek dan gambar bestek

Biaya : Jenis/besarnya pengeluaran yang ada hubungannya dengan borongan yang tercantum dalam persyaratan yang terlampir.

Sedangkan menurut Sugeng Djojowiriono, 1991, Rencana Anggaran Biaya merupakan perkiraan/perhitungan biaya yang diperlukan untuk tiap pekerjaan dalam suatu proyek konstruksi sehingga akan diperoleh biaya total yang diperlukan untuk menyelesaikan suatu proyek.

Berdasarkan beberapa pendapat di atas, dapat didefinisikan bahwa Rencana Anggaran Biaya (RAB) adalah merencanakan suatu bangunan dalam

bentuk dan faedah penggunaannya, beserta besar biaya yang diperlukan dan susunan-susunan dalam bidang administrasi maupun pelaksanaan kerja dalam bidang teknik.

Anggaran biaya suatu bangunan atau proyek adalah perhitungan banyaknya biaya yang diperlukan untuk bahan dan upah tenaga kerja berdasarkan analisis, serta biaya-biaya lain yang berhubungan dengan pelaksanaan bangunan atau proyek tersebut. Biaya adalah jumlah dari masing-masing hasil perkiraan volume dengan harga satuan pekerjaan yang bersangkutan.

Anggaran biaya merupakan harga bangunan yang dihitung dengan teliti, cermat dan memenuhi syarat. Anggaran biaya pada bangunan yang sama akan berbeda-beda di masing-masing daerah, disebabkan perbedaan harga bahan dan upah tenaga kerja. Penaksiran anggaran biaya adalah proses perhitungan volume pekerjaan, harga dari berbagai macam bahan dan pekerjaan yang akan terjadi pada suatu konstruksi.

3.1.2 Tujuan Penyusunan RAB

Tujuan penyusunan atau pembuatan RAB adalah:

1. Bagi Pemilik Proyek

- a. sebagai patokan untuk penyediaan dana,
- b. mengetahui kelayakan dari proyek tersebut dari segi keuangan/ekonomi,
- c. sebagai bahan evaluasi proyek,
- d. sebagai dasar pembandingan dalam proyek,
- e. penentuan besarnya pajak dan asuransi.

2. Bagi Perencana atau Konsultan Manajemen Konstruksi

- a. sebagai bahan perencanaan lebih lanjut,
- b. pemilihan alternatif proyek (luasnya atau batasan penggunaan tipe dan kualitas bahan).

3. Bagi Kontraktor

- a. sebagai dasar untuk mengikuti pelelangan dan pengajuan penawaran,
- b. dasar perkiraan modal atau dana yang harus disediakan,
- c. sebagai dasar dalam penyediaan bahan, alat, tenaga serta waktu untuk pelaksanaan.

Rencana Anggaran Biaya dibuat sebelum proyek dilaksanakan, jadi masih merupakan anggaran biaya perkiraan, bukan anggaran biaya yang sebenarnya berdasarkan pelaksanaan (*actual cost*). Rencana anggaran biaya biasanya dibuat oleh :

- a. Dinas / instansi pemerintah,
- b. Perencana,
- c. Kontraktor.

3.1.3 Data Yang Diperlukan Dalam Pembuatan RAB

Pengumpulan, analisis penerbitan dan penarikan kembali informasi harga dan biaya merupakan hal yang sangat penting bagi sektor dalam industri konstruksi. Sehingga ada harga terbitan yang sering digunakan sebagai acuan

dalam penyusunan rencana anggaran biaya di tiap daerah. Dalam penyusunan/ pembuatan RAB, data yang diperlukan adalah :

1. gambar-gambar rencana arsitek dan struktur (gambar bestek)
2. peraturan dan syarat-syarat (bestek/RKS)
3. berita acara penjelasan pekerjaan,
4. peraturan-peraturan normalisasi yang terkait,
5. peraturan /spesifikasi bahan dari pabrik,
6. daftar harga bahan yang digunakan di daerah tersebut,
7. daftar upah untuk daerah tersebut,
8. daftar upah borongan tiap pekerjaan,
9. peraturan pemerintah daerah yang berkaitan dengan pembangunan,
10. daftar volume pekerjaan.

Dari daftar tersebut jika dibuat skema perhitungan RAB, adalah seperti dalam gambar 3.1 berikut ini:

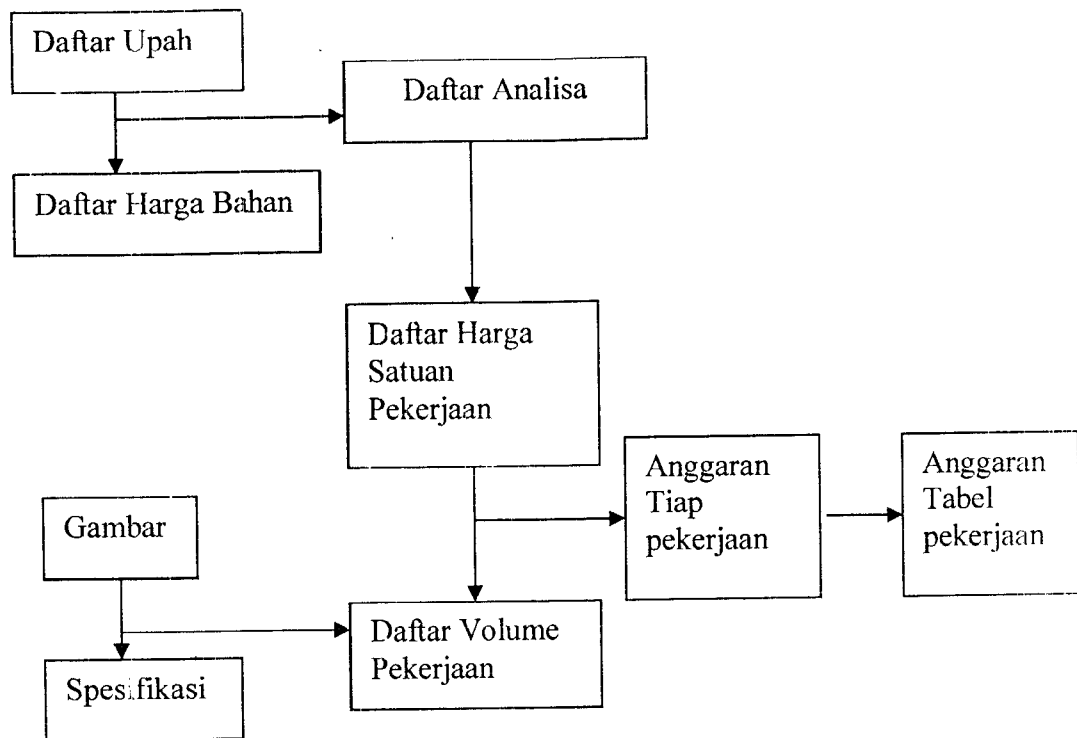

Gambar 3.1 Bagan Perhitungan Anggaran Biaya

Sumber: Sugeng Djojowiriono Manajemen Konstruksi, Yogyakarta, 1984.

3.1.4 Harga Satuan Pekerjaan

Menurut Bachtiar Ibrahim di dalam bukunya *Rencana dan Estimate Real of Cost, 1991*, mendefinisikan bahwa harga satuan pekerjaan adalah jumlah harga bahan dan upah tenaga kerja berdasarkan perhitungan analisis. Analisis adalah merupakan perumusan guna menetapkan harga dan upah masing-masing dalam bentuk satuan. Harga bahan didapat di pasaran, dikumpulkan dalam satu daftar yang dinamakan daftar harga satuan bahan. Upah tenaga kerja di dapatkan di lokasi, dikumpulkan dan dicatat dalam daftar yang dinamakan daftar harga satuan upah tenaga kerja.

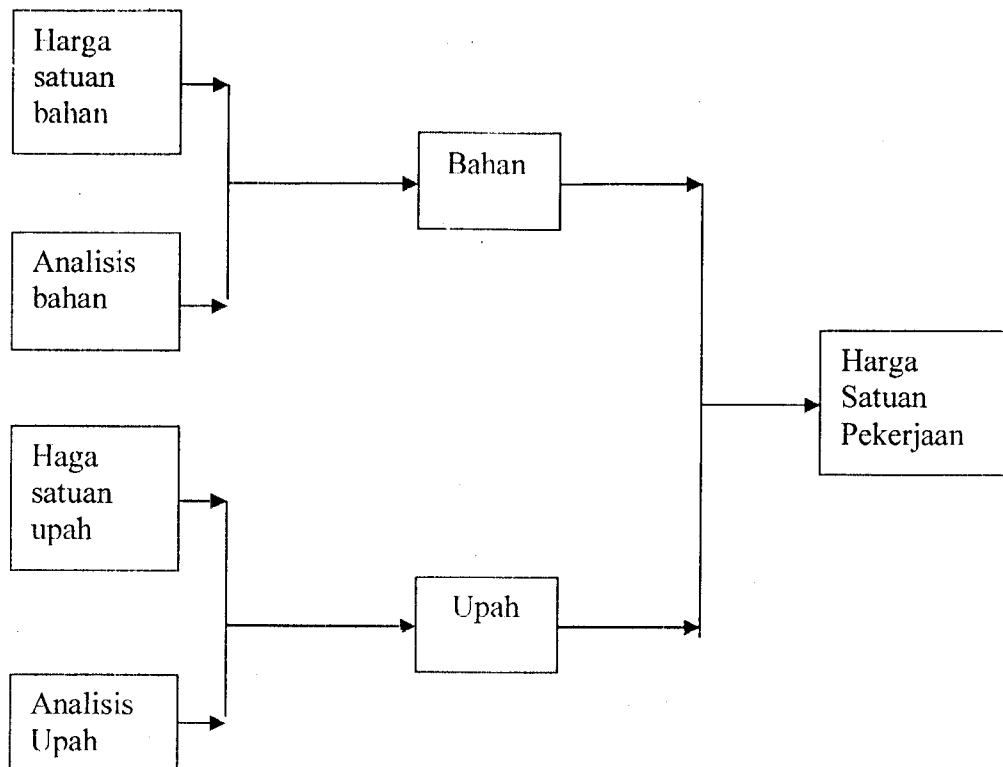

Gambar 3.2 Harga Satuan Pekerjaan

Sumber: Bachtiar Ibrahim, Rencana dan Estimate Real of Cost, Jakarta, 1991.

3.2 Metoda Perhitungan

Rencana Anggaran Biaya proyek gedung dapat dihitung dengan dua metoda. Disamping dengan metoda B.O.W ada juga metoda Non B.O.W (praktis). Untuk lebih jelasnya kedua metoda tersebut dapat dijelaskan berikut ini.

Prinsip yang terdapat dalam metoda B.O.W mencakup daftar koefisien upah dan bahan yang telah ditetapkan. Keduanya menganalisa harga (biaya) yang diperlukan dalam membuat harga satuan pekerjaan bangunan. Dari kedua koefisien tersebut akan didapatkan kalkulasi bahan-bahan yang diperlukan dan kalkulasi upah yang mengerjakan. Komposisi, perbandingan dan susunan material

serta tenaga kerja pada satu pekerjaan sudah ditetapkan, yang selanjutnya dikalikan dengan harga material dan upah yang berlaku saat itu.

Sedangkan analisa dengan metoda praktis, untuk kebutuhan bahan atau material sama dengan metoda B.O.W akan tetapi nilai koefisien bahan dicari berdasarkan gambar rencana dan kebutuhan upah mengacu pada harga borongan. Pada penyusunan Tugas Akhir ini yang digunakan sebagai metoda perhitungan adalah metoda praktis, tanpa membandingkan dengan metoda B.O.W.

3.3 Analisa Anggaran Biaya B.O.W

Prinsip yang terdapat dalam metoda B.O.W mencakup daftar koefisien upah dan bahan yang telah ditetapkan. Keduanya menganalisa harga (biaya) yang diperlukan dalam membuat harga satuan pekerjaan bangunan. Dari kedua koefisien tersebut akan didapatkan kalkulasi bahan-bahan yang diperlukan dan kalkulasi upah yang mengerjakan. Komposisi, perbandingan dan susunan material serta tenaga kerja pada satu pekerjaan sudah ditetapkan, yang selanjutnya dikalikan dengan harga material dan upah yang berlaku saat itu.

Proses perhitungan rencana anggaran biaya metoda B.O.W dapat dilihat pada gambar 3.3 berikut ini :

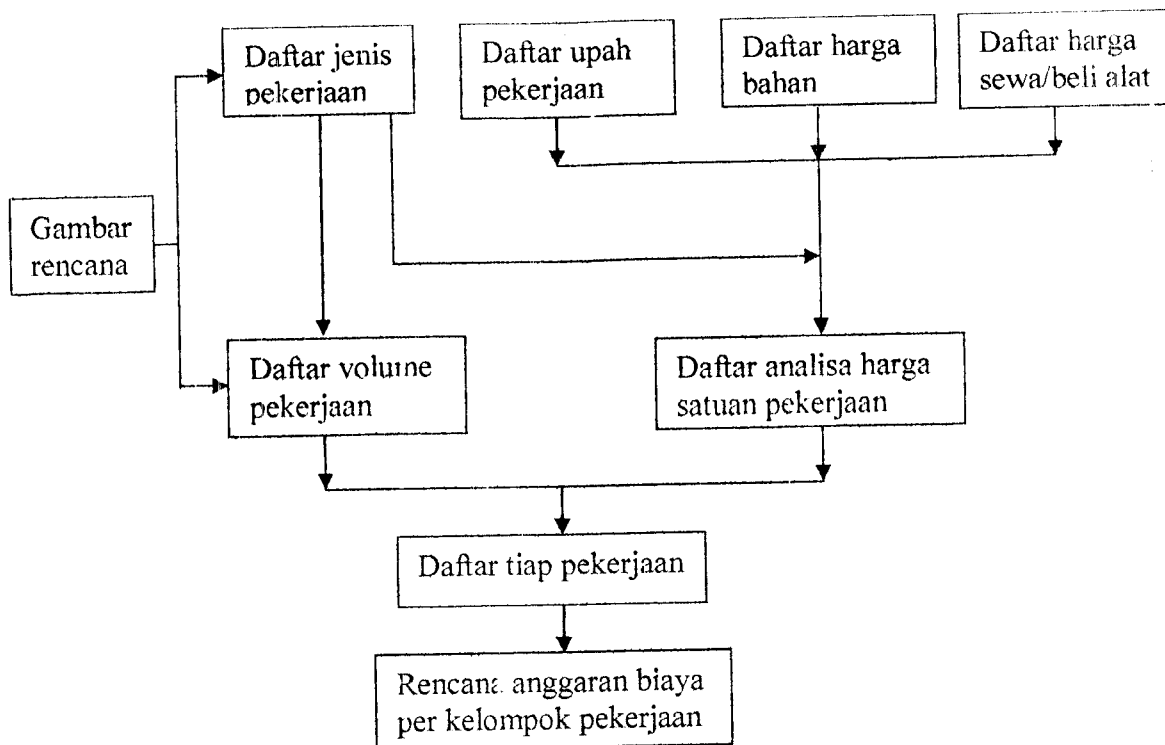

Gambar 3.3 Skema Perhitungan RAB dengan Metoda B.O.W
 Sumber : John W. Niron. Rencana Anggaran Biaya Bangunan, Jakarta, 1992.

Contoh perhitungan analisa anggaran biaya dengan metoda B.O.W :

Harga satuan 1 m³ pekerjaan beton *fc'* 25 Mpa :

1. Bahan : 1 m ³ beton <i>fc'</i> 25 Mpa	@ Rp. 274.000,00	= <u>Rp.274.000,00</u>
	Jumlah harga bahan	= Rp.274.000,00
2. Upah : 1,00 tukang batu	@ Rp. 17.500,00	= Rp. 17.500,00
0,10 kepala tukang batu	@ Rp. 18.000,00	= Rp. 1.800,00
6,00 pekerja	@ Rp. 13.500,00	= Rp. 81.000,00
0,30 mandor	@ Rp. 18.000,00	= <u>Rp. 5.400,00</u>
	Jumlah upah	= Rp.105.700,00

$$\begin{aligned}
 \text{Harga satuan pekerjaan beton } f_c' 25 \text{ Mpa} &= \text{jumlah harga bahan} + \text{jumlah upah} \\
 &= \text{Rp.274.000,00} + \text{Rp.105.700,00} \\
 &= \text{Rp.379.700,00}
 \end{aligned}$$

3.4 Analisa Anggaran Biaya Non B.O.W (Praktis)

Prinsip yang mendasar pada metode praktis adalah analisa koefisien bahan dengan melihat gambar rencana, sedangkan harga upah yang diperhitungkan merupakan upah borongan.

Prinsip perhitungan anggaran biaya dengan menggunakan metoda B.O.W dan Non B.O.W hampir sama akan tetapi pada metoda B.O.W nilai koefisien bahan dan upah sudah ditetapkan sedangkan pada metoda Non B.O.W nilai koefisien bahan dicari berdasarkan gambar rencana dan kebutuhan upah mengacu pada harga upah borongan.

Contoh perhitungan analisa anggaran biaya dengan metoda Non B.O.W (praktis):

Harga satuan 1 m³ pekerjaan beton $f_c' 25 \text{ Mpa}$:

$$1. \text{ Bahan : 1 m}^3 \text{ beton } f_c' 25 \text{ Mpa} \quad @ \text{ Rp. 274.000,00} \quad = \text{Rp.274.000,00}$$

$$2. \text{ Upah borongan : 1 m}^3 \text{ pekerjaan beton} \quad = \underline{\text{Rp. 55.000,00}}$$

$$\text{Jumlah harga bahan + upah} \quad = \text{Rp.329.000,00}$$

$$\text{Harga satuan 1 m}^3 \text{ pekerjaan beton } f_c' 25 \text{ Mpa} = \text{Rp. 329.000,00}$$

Proses perhitungan anggaran biaya metoda praktis dapat dilihat pada gambar 3.4 berikut ini:

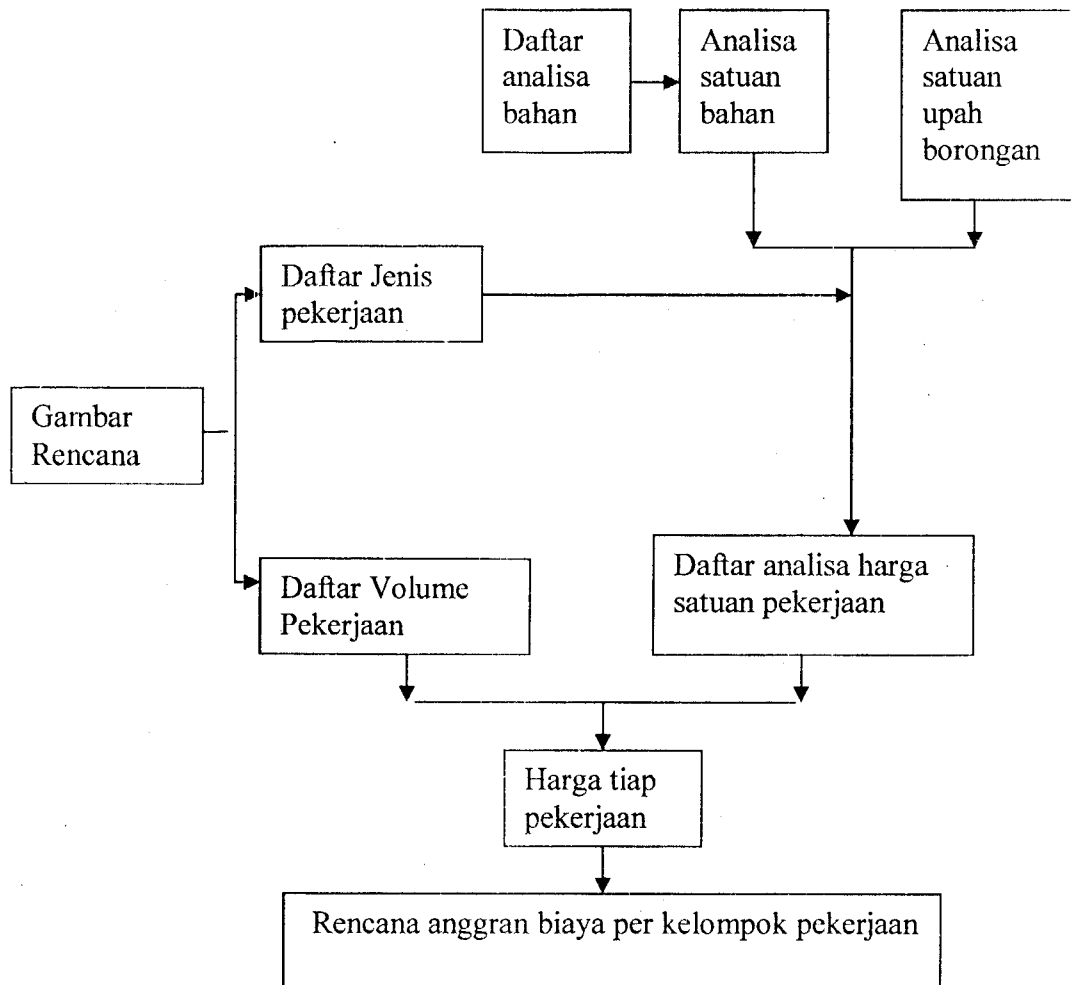

Gambar 3.4 Skema RAB Metode Praktis

Sumber: John W Niron, Rencana Anggaran Biaya Bangunan, Jakarta 1992.

Secara umum proses analisa anggaran biaya metode praktis adalah sebagai berikut:

1. Penentuan jenis-jenis pekerjaan yang akan diperhitungkan anggaran biayanya,
2. Pendataan jenis bahan yang diperlukan sesuai dengan rencana pekerjaan,
3. Penentuan upah pekerja disesuaikan dengan harga borongan,
4. Analisa harga satuan pekerjaan, yang terdiri dari material dan upah,

5. Bagi pekerja yang tidak memerlukan bahan maka harga satuan unit pekerjaan hanya terdiri dari pembayaran upah saja,
6. Setelah diperoleh harga satuan pekerjaan seperti tersebut diatas, selanjutnya volume tiap pekerjaan dikalikan dengan harga satuan pekerjaan, agar diperoleh harga tiap pekerjaan,
7. Penjumlahan seluruh harga tiap pekerjaan akan diperoleh biaya kelompok pekerjaan.

3.5 Pelaksanaan Pekerjaan Konstruksi

Pelaksanaan konstruksi merupakan perwujudan seluruh perencanaan, baik perencanaan gambar maupun metode konstruksi menjadi bentuk bangunan fisik. Macam-macam pekerjaan dalam pelaksanaan konstruksi bangunan gedung secara garis besar, meliputi :

3.5.1 Pekerjaan Struktur Pondasi

Lingkup pekerjaan struktur pondasi meliputi pekerjaan struktur pondasi tiang pancang, pemancangan hingga urugan tanah. Harga bahan / material untuk pekerjaan struktur pondasi diberikan pada tabel 3.1 berikut ini :

Tabel 3.1 Daftar Harga Bahan / Material untuk Pekerjaan Pondasi :

No	Nama Bahan	Satuan	Harga (Rp)
1	Tiang pancang	m'	70.000,-
2	Tanah urug	m ³	25.000,-
3	Sirtu	m ³	30.000,-

Sumber : Standarisasi Harga Barang dan Jasa, 2003.

3.5.2 Pekerjaan Beton

Pekerjaan konstruksi beton dibagi dalam beberapa bagian, yaitu:

1. bekisting, dihitung dalam m^2 ,
2. beton, dihitung dalam m^3 dan pekerjaan pembasahan/pemeliharaan beton setelah dicor,
3. penulangan, dihitung dalam ton atau kilogram,
4. scaffolding, dihitung dalam m^2 .

3.5.3 Bekisting

Bekisting adalah cetakan beton yang merupakan konstruksi sementara yang didalamnya atau diatasnya dapat di stel baja tulangan dan sebagai wadah dari campuran beton yang dicor sesuai bentuk yang dikehendaki. Perhitungan bekisting dibedakan atas beberapa macam, yaitu: pondasi, pelat lantai, atap, kolom, balok, tangga. Biaya yang diperhitungkan sudah termasuk biaya baut, kawat pengikat, minyak pelapis, pembersih dan perbaikan-perbaikan yang diperlukan. Sebanyak 50%-80% dari kayu-kayu cetakan ini dapat digunakan kembali, tetapi hal ini tergantung dari cara membongkar cetakan tersebut. Bila permukaan cetakan dilapisi minyak pelumas, maka jumlah minyak pelumas yang diperlukan sekitar 2-3,75 liter untuk bidang seluas $10m^2$. Proporsi pembiayaan kayu cetakan dapat mencapai sekitar 35% - 60% dari keseluruhan biaya pekerjaan beton bertulang. Daftar harga bahan / material untuk pekerjaan bekisting diberikan pada tabel 3.2 berikut ini :

Tabel 3.2 Daftar Harga Bahan / Material untuk Pekerjaan Bekisting :

No	Nama Bahan	Satuan	Harga (Rp)
1	Multipleks 15 mm	lbr	60.000,-
2	Kayu bekisting (kayu kruing)	m ³	1.700.000,-
3	Paku	kg	6.000,-
4	Minyak pelumas (minyak bekisting)	ltr	12.500,-

Sumber : Standarisasi Harga Barang dan Jasa, 2003.

3.5.4 Campuran Beton

Langkah pertama untuk menghitung biaya campuran beton adalah menghitung volume campuran sejenis. Satuan beton yang dipakai adalah m³. Campuran beton terdiri dari semen, air, kerikil, dan pasir, dengan perbandingan yang dapat didasarkan pada berat atau volume.

Kekuatan beton, keawetan dan kemudahan untuk dikerjakan tergantung dari perbandingan campuran dan nilai faktor air semen (*water cement ratio*). Untuk beton mutu K-125 dapat dipakai campuran dengan perbandingan volume semen : pasir : kerikil = 1 : 2 : 3 atau 1 : 1,5 : 2,5. Untuk campuran dengan mutu yang tinggi, perbandingan tersebut harus direncanakan dengan berdasarkan data otentik dan pengalaman-pengalaman. Dalam perencanaan campuran beton, harus diperhatikan nilai *slump* yang terjadi pada campuran. Bila *slump* campuran kurang dari 5 cm, maka campuran bersifat kental. Bila *slump* campuran sebesar 5 cm sampai 10 cm, maka kekentalan campuran sedang dan bila *slump* campuran sebesar 10 cm sampai 15 cm, berarti campuran basah. Campuran beton dengan *slump* rendah sulit dikerjakan dan mudah terjadi keroposan. Daftar harga bahan /

material untuk pekerjaan campuran beton sebagaimana diberikan pada tabel 3.3 berikut ini :

Tabel 3.3 Daftar Harga Bahan / Material untuk Pekerjaan Campuran Beton

No	Nama Bahan	Satuan	Harga (Rp)
1	Beton <i>ready mix</i> $f_c' 25 \text{ Mpa}$	m ³	274.000,-
2	Semen PC (40 kg)	zak	22.500,-
3	Pasir	m ³	40.000,-
4	Kerikil	m ³	50.000,-
5	Batako	buah	900,-

Sumber : Standarisasi Harga Barang dan Jasa, 2003.

3.5.5 Penulangan

Tulangan beton dihitung berdasarkan berat dalam kg atau ton. Menurut Peraturan Beton Bertulang Indonesia (1971), kait-kait sengkang harus berupa kait yang miring, yang melingkari batang-batang sudut dan mempunyai bagian yang lurus paling sedikit 6 kali diameter batang dengan minimal 5 cm. Untuk menghitung kebutuhan baja tulangan beton, digunakan tabel berat besi sebagaimana diberikan pada tabel 3.4 dan untuk harga bahan / material untuk pekerjaan penulangan diberikan pada tabel 3.5 berikut ini :

Tabel 3.4 Dimeter dan Berat Besi

Jenis Besi		Diameter (mm) – panjang (m)	Berat (kg)	Berat (kg/m)
Polos	Deform			
P6		6 – 12	2,66	0,22
P8		8 – 12	4,47	0,37
P9		9 – 12	6,00	0,50
P10	D10	10 – 12	7,4	0,62
P12		12 – 12	10,66	0,89
P13	D13	13 – 12	12,48	1,04

Lanjutan tabel 3.4 Diameter dan Berat Besi

Jenis Besi		Diameter (mm) – panjang (m)	Berat (kg)	Berat (kg/m)
Polos	Deform			
P16	D16	16 – 12	18,96	1,58
P19	D19	19 – 12	26,76	2,23
P22	D22	22 – 12	35,76	2,98
P25	D25	25 – 12	46,2	3,85
P28		28 -012	57,96	4,83
	D29	29 – 12	62,28	5,19
P32	D32	32 – 12	75,72	6,31
P36	D36	36 – 12	95,88	7,99

Sumber: P2SDM SENSEA, 2004.

Tabel 3.5 Daftar Harga Bahan / Material untuk Pekerjaan Penulangan

No	Nama Bahan	Satuan	Harga (Rp)
1	Besi ulir / deform	kg	3.350,-
2	Besi polos	kg	3.000,-
3	Kawat beton / bendrat	kg	6.500,-

Sumber : Standarisasi Harga Barang dan Jasa, 2003.

3.5.6 Scaffolding / Perancah

Scaffolding / perancah mempunyai bagian-bagian yang dapat di stel menjadi satu kesatuan utuh dengan mempertimbangkan kondisi dan fungsi yang ada pada setiap bagian scaffolding tersebut. Bagian-bagian scaffolding adalah :

1. *Main frame*, merupakan konstruksi utama dari scaffolding dan merupakan penopang bekisting kontak, berbentuk rangka seperti portal memiliki lebar 1,20 m dan tinggi bervariasi yaitu, 0,90 m, 1,50 m, 1,70 m, 1,90 m.

2. *Cross brace* adalah konstruksi silang yang terdiri dari pipa-pipa menyilang/diagonal pada suatu bagian scaffolding. Alat ini berfungsi sebagai pengaku berdirinya main frame. Ukuran cross brace bervariasi dan umumnya panjang maksimal adalah 1,80 m, sehingga area luasan scaffolding adalah 1,20 m x 1,80 m.
3. *Joint pin* adalah alat untuk menyambung antar main frame, ukuran panjang adalah 23 cm.
4. *U-Head* adalah alat untuk penopang gelagar kayu dan untuk tumpuan panel-panel plat dan balok. U-head merupakan bagian teratas dari rangkaian scaffolding dan dapat di stel kedudukannya karena terdapat ulir yang dapat diatur sesuai dengan yang dikehendaki dan panjang maksimal adalah 60 cm.
5. *Jack base* merupakan alat untuk landasan kedudukan scaffolding dan merupakan bagian terbawah dari rangkaian scaffolding, selain itu dapat juga untuk meninggikan kedudukan dari scaffolding. Panjang maksimal jack base adalah 40 cm.

Tabel 3.6 Daftar Harga Sewa Peralatan Scaffolding

No.	Nama bahan / barang	Harga sewa per buah / bulan (Rp)
1	Main frame	3.000,-
2	Cross brace	4.500,-
3	U-head	3.000,-
4	Joint pin	3.000,-
5	Jack base	3.000,-
6	Pipe support	15.000,-

Sumber : Wawancara Tim Perencana Proyek, 2004.

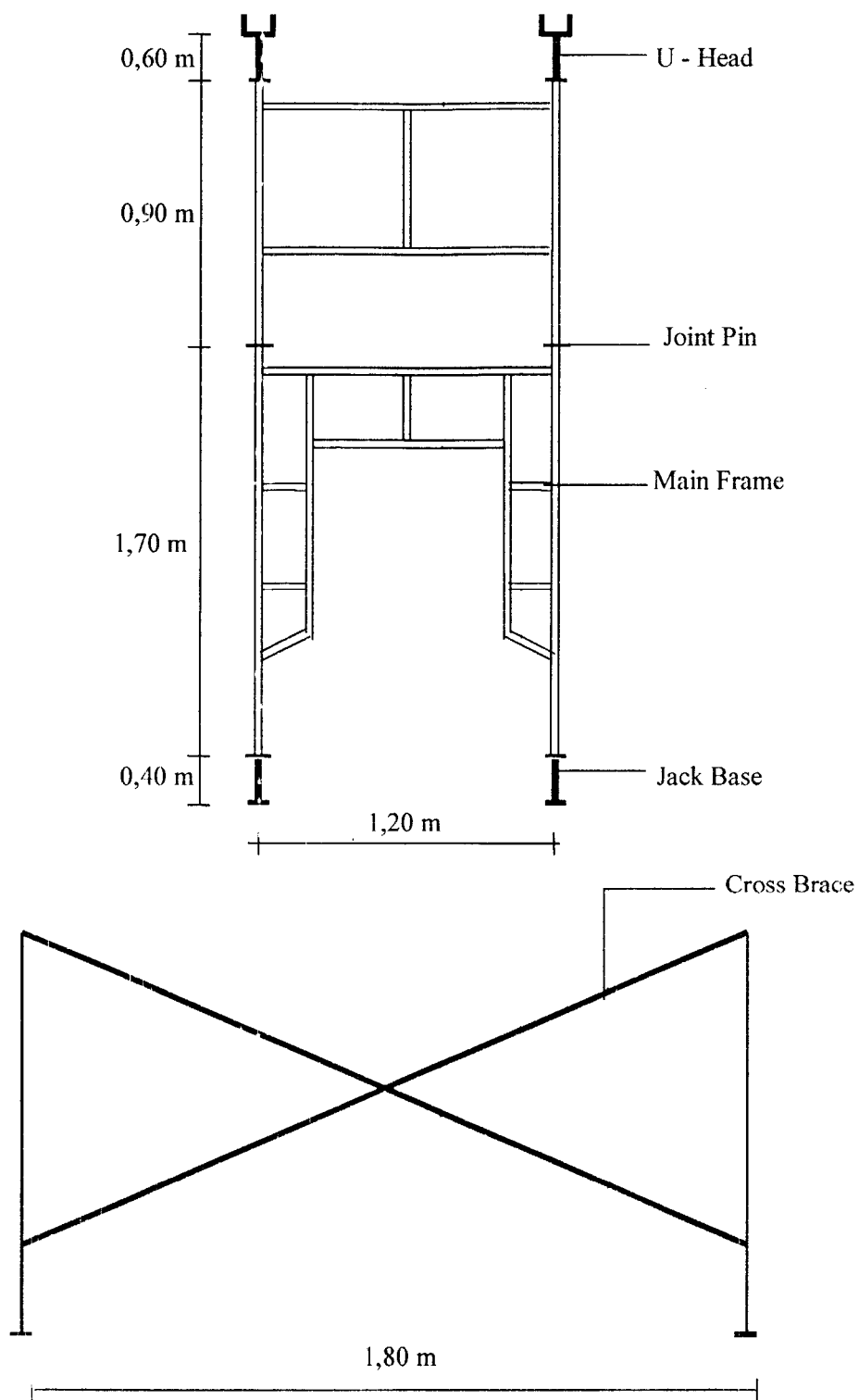

Gambar 3.5 Scaffolding

3.5.7 Pekerjaan Pasangan Batako

Batako terbuat dari campuran semen dan pasir dengan perbandingan tertentu (sesuai mutu yang diinginkan), kemudian campuran dimasukkan ke dalam cetakan yang telah ditentukan ukurannya. Setelah cetakan di bongkar kemudian dikeringkan sampai batako mengeras. Ukuran yang biasa dipakai adalah 40 cm x 10 cm x 20 cm, meskipun dalam praktek banyak penyimpangan ukuran. Kebutuhan spesi / lepa pada pekerjaan batako dapat dilihat pada tabel 3.7 dan komposisi kandungan udara dan air dapat dilihat pada tabel 3.8.

Tabel 3.7 Kebutuhan Spesi / Lepa

No	Uraian Pekerjaan	Bahan Pokok	Perekat (spesi)
1.	1 m ³ Pasangan batu kali pecah	1,05m ³ – 1,2m ³	0,45 m ³
2.	1 m ³ Pasangan batu bata	450 - 600 biji	0,35 m ³
3.	1m ² Pasangan batako	12 biji	0,015 m ³
4.	1 m ³ beton PC (dengan split)	0,8 m ³	0,48
5.	1 m ² Spesi / lepa untuk plesteran 15 mm	-	0,018
6.	1 m ² Spesi/lepa untuk plesteran 10 mm	-	0,012
7.	1 m ² spesi/lepa untuk plesteran 6 mm	-	0,008

Sumber: P2SDM SENSA, 2004.

Untuk semua pekerjaan spesi dan beton yang menggunakan bahan semen, pasir dan kerikil terdapat kandungan udara dan air di dalam bahan-bahan tersebut. Adapun komposisi kandungan udara dan air diberikan pada tabel 3.8 dibawah ini.

Tabel 3.8 Komposisi Kandungan Udara dan Air

No	Uraian	Bahan sesungguhnya (%)	Rongga udara (%)	Air (%)	Bahan Perekat basah (%)
1	Kapur	34	66	18	52
2	Semen (PC)	51	49	25	76
3	Pasir	60	40	7,5	67,50
4	Split (kerikil)	52	48	0	52
5	Semen merah (pecahan bata)	57	43	17,50	74,50

Sumber: P2SDM SENSA, 2004.

BAB IV

METODE PENELITIAN

Metode penelitian merupakan suatu cara pelaksanaan penelitian dalam rangka mencari jawaban atas permasalahan penelitian yang diajukan.

4.1. Subjek Penelitian

Subjek dalam penelitian ini adalah masjid kampus Universitas Muhammadiyah Yogyakarta (UMY).

4.2. Objek Penelitian

Objek dalam penelitian ini adalah menghitung dan menganalisa Rencana Anggaran Biaya (RAB).

4.3. Data yang diperlukan

Data yang diperlukan pada penelitian ini adalah:

1. gambar rencana,
2. daftar harga bahan setempat,
3. daftar upah pekerja dan upah borongan setempat,
4. spesifikasi bahan yang digunakan,

5. Rencana Kerja dan Syarat-syarat (RKS).

4.4. Cara Pengumpulan Data

Cara-cara pengumpulan data dalam penelitian ini adalah:

1. Data primer

Wawancara langsung dengan narasumber di lapangan, yaitu pihak perencana proyek,

2. Data sekunder

Data yang diperoleh dari proyek yaitu yang diperoleh dari gambar rencana proyek.

4.5. Pengolahan Data

Sebelum dilakukan pengolahan data dengan cara perhitungan manual dan menggunakan alat bantu komputer, terlebih dahulu melalui tahapan-tahapan sebagai berikut :

1. studi pustaka dari berbagai buku-buku literatur,
2. merangkum teori yang saling berhubungan antara manajemen konstruksi dan hal-hal lain yang terkait,
3. mengumpulkan data dan penjelasan yang didapat dari pihak perencana proyek pembangunan masjid kampus Universitas Muhammadiyah Yogyakarta,
4. mengumpulkan data yang didapat dari buku pedoman analisa,
5. menganalisa gambar rencana pekerjaan,

6. menghitung volume tiap item pekerjaan,
7. menghitung harga material dan upah tenaga kerja (harga satuan pekerjaan),
8. menganalisa harga tiap pekerjaan,
9. mendapatkan harga tiap pekerjaan dan biaya total proyek.

Hal-hal yang dihitung dengan cara manual adalah sebagai berikut:

1. analisa koefisien bahan,
2. harga satuan pekerjaan,
3. harga pekerjaan.

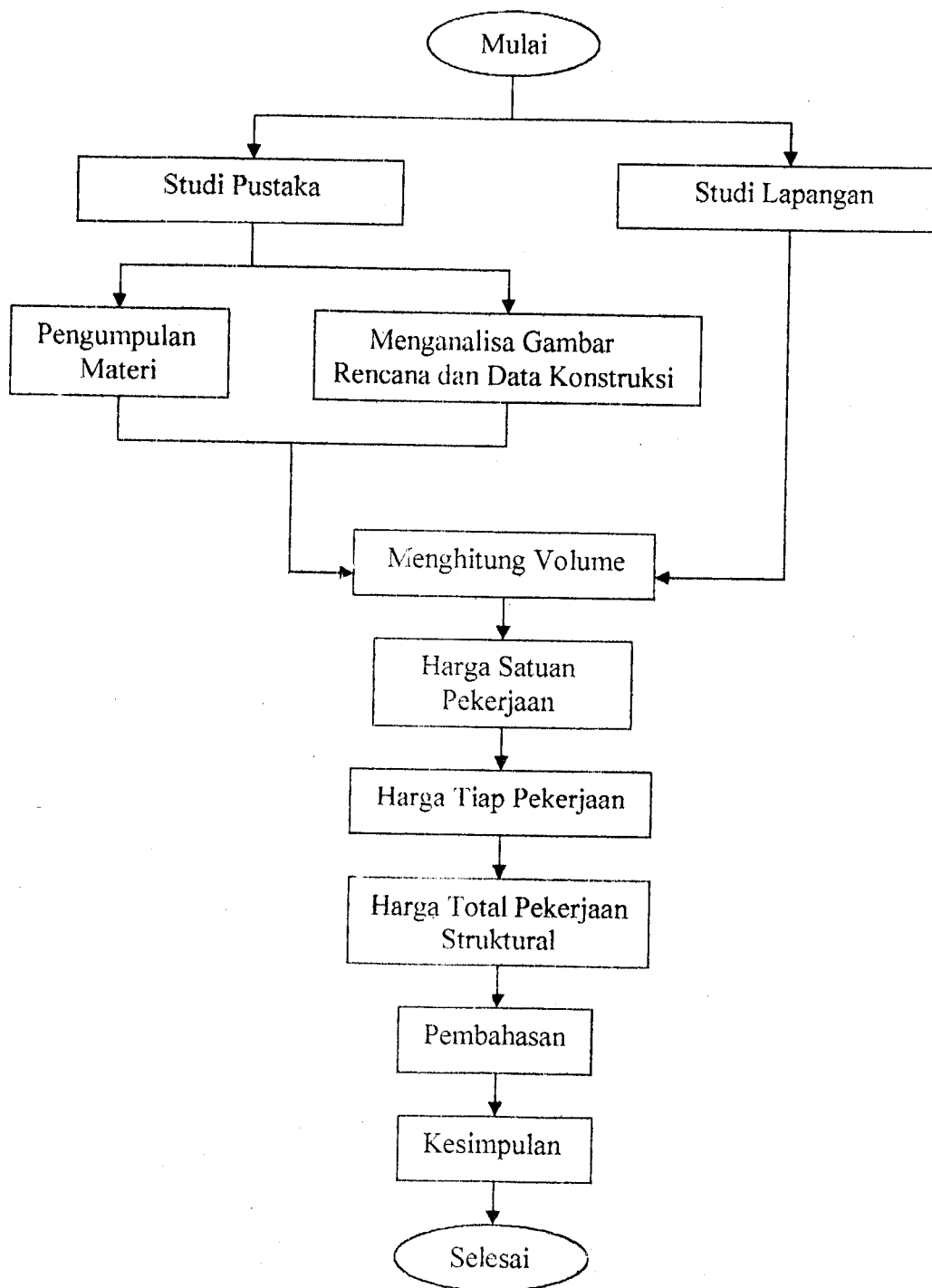

Gambar 4.1 Bagan Alir Penelitian

BAB V

ANALISIS HARGA TIAP PEKERJAAN

5.1 Rencana Pekerjaan

Pada bab ini akan dibahas analisis harga satuan pekerjaan pada pekerjaan yang dilaksanakan pada proyek “ Pembangunan Masjid Kampus Universitas Muhammadiyah Yogyakarta (UMY) “, dengan menggunakan metoda Non BOW (Metoda Praktis). Adapun pekerjaan -- pekerjaan yang di analisa adalah :

Tabel 5.1 Jenis Pekerjaan dan Volume Pekerjaan

No	Uraian Pekerjaan	Volume	Satuan
A	PEKERJAAN PONDASI		
1	Urugan:		
	- Sirtu	3.485,51	m ³
	- Tanah	3.062,06	m ³
2	Kebutuhan bahan (tiang pancang)	3.360,00	m'
3	Lantai kerja di bawah poer pile	232,55	m ²
4	Beton poer pile	141,55	m ³
5	Beton sloof	74,71	m ³
6	Lantai kerja di bawah sloof	204,60	m ²
B	PEKERJAAN STRUKTUR		
I	LANTAI 1		
1	Beton kolom	127,25	m ³
II	LANTAI 2		
1	Beton kolom	110,29	m ³
2	Beton balok	273,95	m ³
3	Beton pelat	159,62	m ³
III	LANTAI 3		
1	Beton kolom	98,20	m ³
2	Beton balok	252,43	m ³
3	Beton pelat	145,63	m ³

Lanjutan tabel 5.1 Jenis Pekerjaan dan Volume Pekerjaan

No	Uraian Pekerjaan	Volume	Satuan
IV	ATAP		
1	Beton kolom	8,17	m ³
2	Beton balok	272,66	m ³
3	Beton pelat	138,20	m ³
4	Beton ring balk	13,57	m ³

5.2 Analisis Harga Tiap Pekerjaan Dengan Metoda Non BOW

5.2.1 Pekerjaan Urugan

Pada proyek ini memerlukan urugan sirtu dan tanah yang cukup banyak sebab elevasi lantai dasar 0,00 berada 2 m diatas permukaan tanah asli. Untuk pekerjaan urugan ini, sirtu di datangkan dari sungai Krasak dan untuk tanah urug di datangkan dari daerah Potorono, Bantul.

$$1. \text{ Volume pekerjaan urugan sirtu} = 3.485,50 \text{ m}^3$$

- Biaya urugan 1 m³ sirtu :

$$1,00 \text{ m}^3 \text{ sirtu} \dots\dots\dots @ \text{ Rp. } 30.000,00 = \text{Rp. } 30.000,00$$

$$\text{Upah borongan per m}^3 \dots\dots\dots @ \text{ Rp. } 5.500,00 = \underline{\text{Rp. } 5.500,00}$$

$$\text{Total biaya per m}^3 = \text{Rp. } 35.500,00$$

$$\text{Harga satuan pekerjaan urugan sirtu} = \text{Rp. } 35.500,00$$

$$\text{Harga pekerjaan urugan sirtu} = 3.485,50 \text{ m}^3 \times \text{Rp. } 35.500,00$$

$$= \text{Rp. } 123.735.250,00$$

2. Volume pekerjaan urugan tanah = 3.062 m^3

- Biaya urugan 1 m^3 tanah :

$1,10 \text{ m}^3$ tanah urug @ Rp. 25.000,00 = Rp. 27.500,00

Upah borongan per m^3 @ Rp. 5.500,00 = Rp. 5.500,00

Total biaya per m^3 = Rp. 33.000,00

Harga satuan pekerjaan urugan tanah = Rp. 33.000,00

Harga pekerjaan urugan tanah = $3.062 \text{ m}^3 \times \text{Rp. } 33.000,00$

= Rp. 101.046.000,00

- Harga total pekerjaan urugan = Rp.134.192.135,00 + Rp.101.047.980,00

= Rp. 224.781.250,00

5.2.2 Pekerjaan Tiang Pancang

Pada pekerjaan tiang pancang menggunakan tiang pancang dengan tinggi tiang pancang 12 m'. Banyaknya tiang pancang yang dibutuhkan adalah 280 buah.

Maka kebutuhan tiang pancang adalah :

Kebutuhan tiang pancang = tinggi pile x jumlah pile

= $12 \text{ m}' \times 280 = 3.360 \text{ m}'$.

Didapat kebutuhan tiang pancang dan pemancangan = $3.360 \text{ m}'$.

- Biaya tiang pancang per m' :

$1,00 \text{ m}'$ tiang pancang@ Rp. 70.000,00 = Rp. 70.000,00

Upah + alat pemancangan@ Rp. 25.000,00 = Rp. 25.000,00

Total biaya per m' = Rp. 95.000,00

Harga pekerjaan tiang pancang = $3.360 \text{ m}' \times \text{Rp. } 95.000,00 = \text{Rp. } 319.200.000,00$

5.2.3 Pekerjaan Lantai Kerja di Bawah Poer dan Bawah Sloof Tebal 10 cm

1. Lantai kerja di bawah poer pile :

Volume lantai kerja = panjang poer x lebar poer x jumlah poer

- Poer pile tipe 2 : panjang poer = 1,80 m ; lebar poer = 1,00 m ; jumlah poer = 12

$$\text{Volume lantai kerja} = 1,80 \times 1,00 \times 12 = 21,60 \text{ m}^2$$

Tabel 5.2 Perhitungan Volume Beton Lantai Kerja di bawah Poer Pile

No	Tipe	Panjang Poer (m)	Lebar Poer (m)	Volume (m ²)	Jml Tipe	Volume Total (m ²)
A	B	C	d	e = c x d	f	g = e x f
1	2	1,80	1,00	1,80	12	21,60
2	3	1,69	1,69	2,86	8	22,85
3	4	1,80	1,80	3,24	16	51,84
4	5	2,13	2,13	4,54	6	27,22
5	7	2,39	2,60	6,21	6	37,28
6	9	2,60	2,60	6,76	8	54,08
7	12	3,40	2,60	8,84	2	17,68
			Jumlah	34,25	58	232,55

2. Lantai kerja di bawah sloof :

Volume lantai kerja = (0,20 + lebar sloof) x panjang sloof x jumlah sloof

- Sloof tipe S1 : panjang sloof = 8,20 m ; lebar sloof = 0,40 m ; jumlah sloof = 13

$$\text{Volume lantai kerja} = (0,20 + 0,40) \times 8,20 \times 13 = 63,96 \text{ m}^2$$

Tabel 5.3 Perhitungan Volume Beton Lantai Kerja di bawah Sloof

No	Tipe	Panjang Sloof (m)	Lebar Sloof (m)	Volume (m ²)	Jml Tipe	Volume Total (m ²)
A	b	c	d	e=(0,2+d)xc	f	g = e x f
I.1	S1	8,20	0,40	4,92	13	63,96
I.2	S1	8,60	0,40	5,16	4	20,64
I.3	S1	7,80	0,40	4,68	2	9,36
I.4	S1	7,40	0,40	4,44	1	4,44
I.5	S1	9,00	0,40	5,40	1	5,40
I.6	S1	5,00	0,40	3,00	10	30,00
I.7	S1	1,80	0,40	1,08	4	4,32

Lanjutan tabel 5.3 Perhitungan Volume Beton Lantai Kerja di bawah Sloof

No	Tipe	Panjang Sloof (m)	Lebar Sloof (m)	Volume (m ²)	Jml Tipe	Volume Total (m ²)
a	b	c	d	$e=(0,2+d)xc$	f	$g = e \times f$
II.1	S2	5,07	0,30	2,54	4	10,14
II.2	S2	4,60	0,30	2,30	4	9,20
II'.1	S2'	9,00	0,30	4,50	1	4,50
II'.2	S2'	7,40	0,30	3,70	2	7,40
II'.3	S2'	3,27	0,30	1,64	4	6,54
II'.4	S2'	1,65	0,30	0,83	4	3,30
II'.5	S2'	1,95	0,30	0,98	4	3,90
III	S3	9,00	0,30	4,50	3	13,50
IV.1	S4	1,80	0,30	0,90	6	5,40
IV.2	S4	2,60	0,30	1,30	2	2,60
			Jumlah	51,85	69	204,60

Volume total beton lantai kerja = volume di bawah poer + volume di bawah sloof

$$= 232,55 + 204,60 = 437,15 \text{ m}^2$$

- Analisis koefisien bahan

Kebutuhan spesi 1 m³. Menggunakan semen pc = 40 kg atau 1 m³ = 1.250 kg (P2SDM), sedangkan bahan perekat basah dapat dilihat pada tabel 3.8 yaitu untuk semen pc = 0,76, pasir = 0,675, dan kerikil = 0,52. Dan untuk nilai *safety* semen pc = 5 %, pasir = 10 %, kerikil = 5 %.

Perbandingan campuran untuk beton lantai kerja : 1pc : 3ps : 5kr

Jumlah bahan perekat basah dalam 1 m³ :

$$1 \text{ pc} = 1 \times 0,76 = 0,76 \text{ m}^3$$

$$3 \text{ pasir} = 3 \times 0,675 = 2,025 \text{ m}^3$$

$$5 \text{ kerikil} = 5 \times 0,52 = 2,60 \text{ m}^3$$

$$\text{Jumlah} = 5,385 \text{ m}^3$$

$$\text{PC} = (1 / 5,385) \times 0,76 = 0,1411 \text{ m}^3$$

$$\text{Pasir} = (1 / 5,385) \times 2,025 = 0,3761 \text{ m}^3$$

$$\text{Kerikil} = (1 / 5,385) \times 2,60 = \underline{0,4828 \text{ m}^3}$$

$$\text{Jumlah} = 1,0000 \text{ m}^3 \text{ (sesuai dengan kebutuhan spesi).}$$

Jumlah kering bahan dalam 1 m³ :

$$\text{PC} = (0,1411 / 0,76) \times 1.250 \text{ kg}$$

$$= 232,0723 \text{ kg} / 40 \text{ kg}$$

$$= 5,8018 + 5 \%$$

$$= 6,0919 \text{ zak}$$

$$\text{Pasir} = 0,3761 / 0,675$$

$$= 0,5572 + 10 \%$$

$$= 0,6129 \text{ m}^3$$

$$\text{Kerikil} = 0,4828 / 0,52$$

$$= 0,9285 - 5 \%$$

$$= 0,9749 \text{ m}^3$$

Sehingga di dapat nilai koefisien bahan sebagai berikut :

$$6,0919 \text{ zak pc} : 0,6129 \text{ m}^3 \text{ pasir} : 0,9749 \text{ m}^3 \text{ kerikil.}$$

- Biaya 1 m³ untuk beton lantai kerja tebal 10 cm :

6,0919 zak pc@ Rp. 22.500,00 = Rp. 137.067,75

0,6129 m³ pasir@ Rp. 40.000,00 = Rp. 24.516,00

0,9749 m³ kerikil@ Rp. 50.000,00 = Rp. 48.745,00

Jumlah = Rp. 210.328,75

1 m³ upah borongan@ Rp. 45.000,00 = Rp. 45.000,00

Jumlah = Rp. 255.328,75

1 m² lantai kerja tebal 10 cm0,10 x Rp. 255.328,75 = Rp. 25.532,88

Harga satuan pekerjaan lantai kerja = Rp. 25.532,88

Tabel 5.4 Harga Satuan Pekerjaan Lantai Kerja

Uraian	Vol.	Sat.	Harga Satuan (Rp)	Analisa Harga Bahan (Rp)	Analisa Harga Upah (Rp)	Total Harga Analisa (Rp)
BAHAN						
Seman PC	0,61	zak	22.500,00	13.706,78		
Pasir	0,06	m ³	40.000,00	2.451,60		
Kerikil	0,09	m ³	50.000,00	4.874,50		21.032,88
UPAH BORONGAN						
Upah cor	1,00	m ²	4.500,00		4.500,00	4.500,00
					Jumlah	25.532,88
					Dibulatkan	25.533,00

Pekerjaan lantai kerja mempunyai volume total 437,15 m², maka :

Harga pekerjaan lantai kerja = 437,15 m² x Rp. 25.532,88

= Rp. 11.161.698,49

5.2.4 Pekerjaan Beton Poer Pile

Poer Pile Tipe 2

Jumlah poer pile tipe 2 = 12 buah

Panjang bersih poer = 1,60 m

Lebar bersih poer = 0,80 m

Tinggi batas cor = 0,60 m

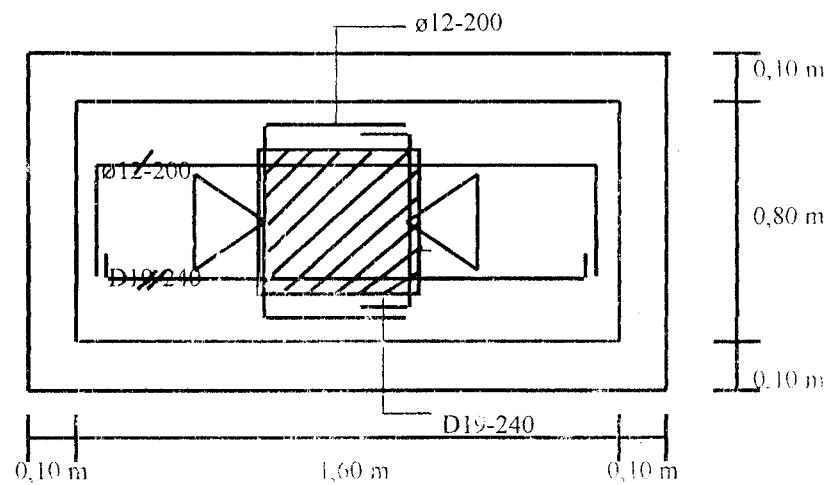
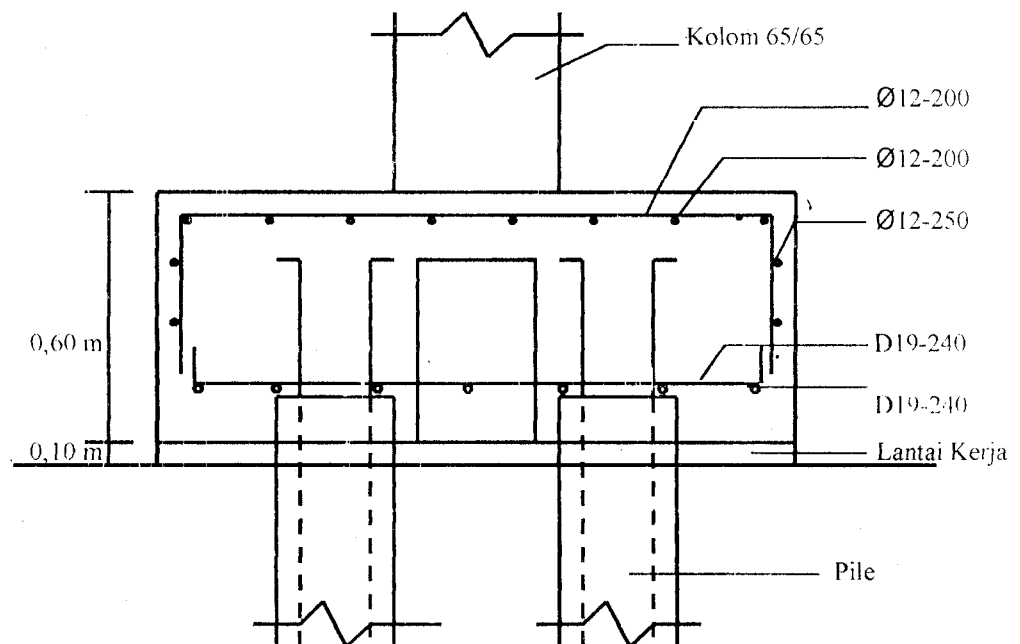

Volume beton satu buah poer pile tipe 2 = $1,60 \times 0,80 \times 0,60 = 0,77 \text{ m}^3$

Volume total beton poer pile tipe 2 = $0,77 \times 12 = 9,22 \text{ m}^3$

Untuk perhitungan volume beton poer pile tipe yang lain, dapat dilihat pada lampiran 4 perhitungan volume beton poer pile.

1. Beton

- Biaya 1 m³ beton $f_c' 25 \text{ Mpa}$:

1 m³ beton ready mix $f_c' 25 \text{ Mpa}$ = Rp. 274.000,00

Upah cor..... = Rp. 32.500,00

Jumlah = Rp. 306.500,00

Harga satuan pekerjaan pencoran beton = Rp. 306.500,00

2. Besi Beton

Perhitungan kebutuhan besi :

- Tulangan susut P12 – 200 (arah sumbu x)

Panjang satu buah tulangan = panjang poer - selimut kolom + tulangan tekuk

$$= 1,60 - (2 \times 0,05) + (2 \times 0,40) = 2,30 \text{ m}$$

Jumlah tulangan arah lebar poer = (lebar poer / jarak antar tulangan) + 1

$$= (0,70 / 0,20) + 1 = 5 \text{ buah}$$

Berat tulangan = $5 \times 2,30 \times 0,89 \text{ kg/m} = 10,24 \text{ kg}$

- Tulangan pokok D19 – 240 (arah sumbu x)

Panjang satu buah tulangan = panjang poer = 1,60 m

$$\begin{aligned} \text{Jumlah tulangan arah lebar poer} &= (\text{lebar poer} / \text{jarak antar tulangan}) + 1 \\ &= (0,70 / 0,24) + 1 = 4 \text{ buah} \end{aligned}$$

$$\text{Berat tulangan} = 4 \times 1,60 \times 2,23 \text{ kg/m} = 14,27 \text{ kg}$$

- Tulangan susut P12 – 200 (arah sumbu y)

$$\begin{aligned} \text{Panjang satu buah tulangan} &= \text{lebar poer} - \text{selimut kolom} + \text{tulangan tekuk} \\ &= 0,80 - (2 \times 0,05) + (2 \times 0,40) = 1,50 \text{ m} \end{aligned}$$

$$\begin{aligned} \text{Jumlah tulangan arah panjang poer} &= (\text{panjang poer} / \text{jarak antar tulangan}) + 1 \\ &= (1,50 / 0,20) + 1 = 9 \text{ buah} \end{aligned}$$

$$\text{Berat tulangan} = 9 \times 1,50 \times 0,89 \text{ kg/m} = 12,02 \text{ kg}$$

- Tulangan pokok D19 – 240 (arah sumbu y)

$$\text{Panjang satu buah tulangan} = \text{lebar poer} = 0,80 \text{ m}$$

$$\begin{aligned} \text{Jumlah tulangan arah panjang poer} &= (\text{panjang poer} / \text{jarak antar tulangan}) + 1 \\ &= (1,50 / 0,24) + 1 = 8 \text{ buah} \end{aligned}$$

$$\text{Berat tulangan} = 8 \times 0,80 \times 2,23 \text{ kg/m} = 14,27 \text{ kg}$$

- Tulangan susut P12 – 250

$$\begin{aligned} \text{Panjang satu buah tulangan} &= \text{keliling poer} - \text{selimut kolom} + 2 \text{ kait} \\ &= ((0,80+1,60) \times 2) - (4 \times 0,05) + (2 \times 0,05) = 4,70 \text{ m} \end{aligned}$$

$$\begin{aligned} \text{Jumlah tulangan arah tinggi poer} &= (\text{tinggi poer} / \text{jarak antar tulangan}) + 1 \\ &= (0,50 / 0,25) + 1 = 3 \text{ buah} \end{aligned}$$

$$\text{Berat tulangan} = 3 \times 4,70 \times 0,89 \text{ kg/m} = 12,55 \text{ kg}$$

- Berat total besi tulangan polos = $10,24 + 12,02 + 12,55 = 34,80 \text{ kg}$
- Berat total besi tulangan ulir = $14,27 + 14,27 = 28,54 \text{ kg}$

$$\text{Volume beton} = 1,60 \times 0,80 \times 0,60 = 0,77 \text{ m}^3$$

Jadi dalam 1 m³ beton kebutuhan besi tulangan polos =

$$(1 / 0,77) \times 34,80 = 45,19 \text{ kg}$$

- Biaya penulangan untuk 1 kg besi polos :

1,1000 kg besi polos	@ Rp. 3.000,00	= Rp. 3.300,00
0,0200 kg kawat beton	@ Rp. 6.500,00	= <u>Rp. 130,00</u>
Jumlah		= Rp. 3.430,00
Upah borongan		= <u>Rp. 200,00</u>
Jumlah (upah + bahan)		= Rp. 3.630,00

Tiap 1 m³ beton perlu besi tulangan polos 45,19 kg, jadi :

$$45,19 \text{ kg} \times \text{Rp. } 3.630,00 = \text{Rp. } 164.922,00$$

Jadi dalam 1 m³ beton kebutuhan besi tulangan ulir =

$$(1 / 0,77) \times 28,54 = 37,07 \text{ kg}$$

- Biaya penulangan untuk 1 kg besi ulir :

1,1000 kg besi ulir	@ Rp. 3.350,00	= Rp. 3.685,00
0,0200 kg kawat beton	@ Rp. 6.500,00	= <u>Rp. 130,00</u>
Jumlah		= Rp. 3.815,00
Upah borongan		= <u>Rp. 200,00</u>
Jumlah (upah + bahan)		= Rp. 4.015,00

Tiap 1 m³ beton perlu besi tulangan ulir 37,07 kg, jadi :

$$37,07 \text{ kg} \times \text{Rp. } 4.015,00 = \text{Rp. } 149.579,00$$

$$\begin{aligned}
 \text{- Harga satuan pekerjaan penulangan} &= \text{harga penulangan besi polos} + \text{harga} \\
 &\quad \text{penulangan besi ulir} \\
 &= \text{Rp. 164.922,00} + \text{Rp. 149.579,00} \\
 &= \text{Rp. 314.501,00}
 \end{aligned}$$

Untuk perhitungan kebutuhan besi tulangan poer pile tipe yang lain, dapat dilihat pada lampiran 4 perhitungan kebutuhan besi tulangan pokok poer pile dan disajikan pula rekapitulasi kebutuhan besi tulangan ulir dan polos poer pile.

3. Bekisting Batako

Bekisting poer pile menggunakan pasangan batako dengan spesi 1 pc : 2 ps

$$\text{Jumlah tipe poer} = 12 \text{ buah}$$

$$\text{Tinggi pasangan batako} = 0,60 \text{ m}$$

$$\text{Lebar pasangan batako} = 0,80 \text{ m}$$

$$\text{Panjang pasangan batako} = 1,80 \text{ m}$$

$$\begin{aligned}
 \text{Volume satu buah bekisting pasangan batako} &= (0,8 \times 0,6 \times 2) + (1,8 \times 0,6 \times 2) \\
 &= 3,12 \text{ m}^2
 \end{aligned}$$

$$\text{Volume total bekisting pasangan batako poer pile tipe 2} = 3,12 \times 12 = 37,44 \text{ m}^2$$

$$\text{Volume beton poer pile tipe 2} = 1,6 \times 0,8 \times 0,6 = 0,77 \text{ m}^3$$

Jadi dalam 1 m³ beton kebutuhan bekisting pasangan batako =

$$(1 / 0,77) \times 3,12 = 4,05 \text{ m}^2$$

Untuk perhitungan volume bekisting pasangan batako poer pile tipe yang lain, dapat dilihat pada lampiran 4 perhitungan volume bekisting pasangan batako poer pile.

- Analisa keefisien bahan

Kebutuhan batako 1 m^2 adalah 12 buah dan kebutuhan spesi yaitu $0,015 \text{ m}^3$ (tabel 3.7). Menggunakan semen pc = 40 kg atau $1 \text{ m}^3 = 1.250 \text{ kg}$ (P2SDM), sedangkan bahan perekat basah dapat dilihat pada tabel 3.8 yaitu untuk semen pc = 0,76 dan pasir = 0,675. Dan untuk nilai *safety* semen pc = 5 % ; pasir = 10 %.

Jumlah bahan perekat basah dalam 1 m^2 :

$$1 \text{ pc} = 1 \times 0,76 = 0,76 \text{ m}^3$$

$$2 \text{ pasir} = 2 \times 0,675 = 1,35 \text{ m}^3$$

$$\text{Jumlah} = 2,11 \text{ m}^3$$

$$\text{PC} = (0,015 / 2,11) \times 0,76 = 0,0054$$

$$\text{Pasir} = (0,015 / 2,11) \times 1,35 = 0,0096$$

$$\text{Jumlah} = 0,0150 \text{ m}^3 \text{ (sesuai dengan kebutuhan spesi)}.$$

Jumlah kering bahan dalam 1 m^2 :

$$\text{PC} = (0,0054 / 0,76) \times 1.250 \text{ kg}$$

$$= 8,8816 \text{ kg} / 40 \text{ kg}$$

$$= 0,2220 + 5 \%$$

$$= 0,2331 \text{ zak}$$

$$\text{Pasir} = 0,0096 / 1,35$$

$$= 0,0071 + 10 \%$$

$$= 0,0078 \text{ m}^3$$

Sehingga didapat nilai koefisien bahan sebagai berikut :

12 buah batako : 0,2331 zak pc : 0,0078 m³ pasir.

- Biaya 1 m² bekisting pasangan batako :

12 buah batako	@ Rp. 900,00	= Rp. 18.000,00
0,2331 zak pc	@ Rp. 22.500,00	= Rp. 5.244,75
0,0078 m ³ pasir	@ Rp. 40.000,00	= <u>Rp. 312,00</u>
		Jumlah	= Rp. 23.556,75
Upah borongan		= <u>Rp. 4.500,00</u>
		Total	= Rp. 28.056,75

- Biaya bekisting batako untuk 1 m³ beton :

49 buah batako	@ Rp. 900,00	= Rp. 44.100,00
0,9441 zak pc	@ Rp. 22.500,00	= Rp. 21.242,25
0,0316 m ³ pasir	@ Rp. 40.000,00	= <u>Rp. 1.264,00</u>
		Jumlah	= Rp. 66.606,25
Upah borongan :	4,05 m ² x Rp. 4.500,00.....		= <u>Rp. 18.225,00</u>
		Jumlah	= Rp. 84.831,25
Harga satuan pekerjaan bekisting		= Rp. 84.831,25

Harga satuan pekerjaan poer pile tipe 2, adalah :

- Biaya cor	= Rp. 306.500,00
- Biaya penulangan.....		= Rp. 314.501,00
- Biaya bekisting.....		= <u>Rp. 84.831,25</u>
		Jumlah = Rp. 705.832,25

Tabel 5.5 Harga Satuan Pekerjaan Poer Pile Tipe 2

Uraian	Vol.	Sat.	Harga Satuan (Rp)	Analisa Harga Bhn (Rp)	Analisa Harga Upah (Rp)	Total Harga Analisa (Rp)
BAHAN						
Beton ready mix	1,00	m ³	274.000,00	274.000,00		
Besi ulir	40,78	kg	3.350,00	136.613,00		
Besi polos	49,71	kg	3.000,00	149.130,00		
Bendrat	1,64	kg	6.500,00	10.660,00		
Batako	49	buah	900,00	44.100,00		
Semar. PC	0,94	zak	22.500,00	21.242,25		
Pasir	0,03	m ³	40.000,00	1.264,00		637.009,25
UPAH BORONGAN						
Cor ready mix	1,00	m ³	32.500,00		32.500,00	
Buat + stel besi	90,49	kg	200,00		18.098,00	
Bekisting pas. batako	4,05	m ²	4.500,00		18.225,00	68.823,00
					Jumlah	705.832,25
					Dibulatkan	705.832,00

Pekerjaan poer pile tipe 2 mempunyai volume beton 9,22 m³, maka :

$$\text{Harga pekerjaan poer pile tipe 2} = 9,22 \text{ m}^3 \times \text{Rp. } 705.832,25$$

$$= \text{Rp. } 6.507.773,35$$

Pada lampiran 4 diberikan juga harga satuan pekerjaan tiap tipe poer pile dan harga tiap pekerjaan poer pile tipe yang lainnya.

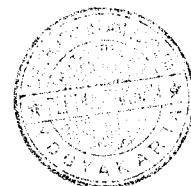

5.2.5 Pekerjaan Beton Balok Sloof

Balok Sloof Tipe S1 (40/60)

Lebar balok sloof = 0,40 m

Tinggi balok sloof = 0,60 m

Panjang sloof (as ke as) = 10,80 m

Panjang bersih sloof = 8,20 m

Jumlah balok sloof tipe S1 = 13 buah

Volume beton satu buah sloof S1 = $0,40 \times 0,60 \times 8,20 = 1,97 \text{ m}^3$

Volume beton total sloof S1 = $1,97 \times 13 = 25,58 \text{ m}^3$

Untuk perhitungan volume beton balok sloof tipe yang lain, dapat dilihat pada lampiran 5 perhitungan volume bekisting dan volume beton balok sloof.

1. Beton

- Biaya 1 m³ beton $f_c' 25 \text{ Mpa}$:

1 m³ beton ready mix $f_c' 25 \text{ Mpa}$ = Rp. 274.000,00

Upah cor..... = Rp. 32.500,00

Jumlah = Rp. 306.500,00

Harga satuan pekerjaan pencoran beton = Rp. 306.500,00

2. Besi beton

Perhitungan kebutuhan besi :

* Tulangan sengkang / begel $\varnothing 8-150$.

Panjang satu buah tulangan begel :

Keliling sloof – selimut kolom + 2 kait

$$= ((0,4 + 0,6) \times 2) - (0,04 \times 4) + (2 \times 10 \times 0,008) = 2,00 \text{ m}$$

Jumlah tulangan begel : (panjang besi / jarak antar sengkang) + 1 buah

$$= (10,15 / 0,15) + 1 = 69 \text{ buah}$$

Berat besi begel : jumlah begel x panjang 1 buah begel x berat (kg/m)

$$= 69 \times 2,00 \times 0,37 = 51,06 \text{ kg}$$

* Tulangan Tumpuan

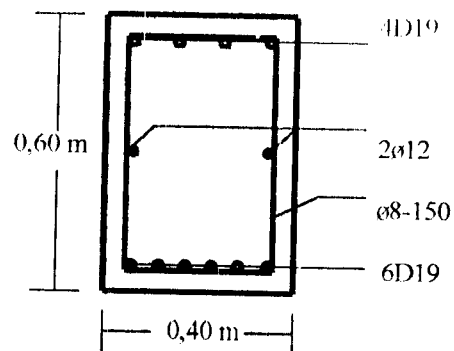

- Kebutuhan besi tulangan tumpuan atas 4D19 untuk satu sloof :

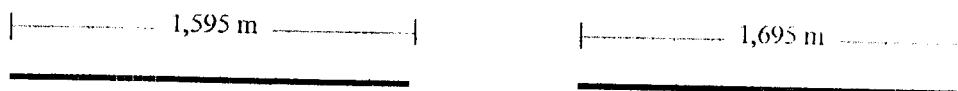

(panjang tulangan + perpanjangan) x jumlah tulangan tumpuan

$$= ((1,595 + (40 \times 0,019)) \times 4) = 16,20 \text{ m}$$

Berat tulangan tumpuan atas = $16,20 \text{ m} \times 2,23 \text{ kg/m} = 36,13 \text{ kg}$

- Kebutuhan besi tulangan tumpuan bawah 6D19 untuk satu sloof :



(panjang tulangan + kait + perpanjangan) x jumlah tulangan tumpuan

$$= (5,40 + (2 \times 5 \times 0,019) + (40 \times 0,019)) \times 2 = 12,70 \text{ m}$$

Berat tulangan tumpuan bawah = $12,70 \text{ m} \times 2,23 \text{ kg/m} = 28,32 \text{ kg}$



(panjang tulangan + perpanjangan) x jumlah tulangan tumpuan

$$= (5,40 + (40 \times 0,019)) \times 4 = 24,64 \text{ m}$$

Berat tulangan tumpuan bawah = $24,64 \text{ m} \times 2,23 \text{ kg/m} = 54,95 \text{ kg}$

- Berat total tulangan tumpuan = $36,13 + 28,32 + 54,95 = 119,40 \text{ kg}$

* Tulangan Lapangan

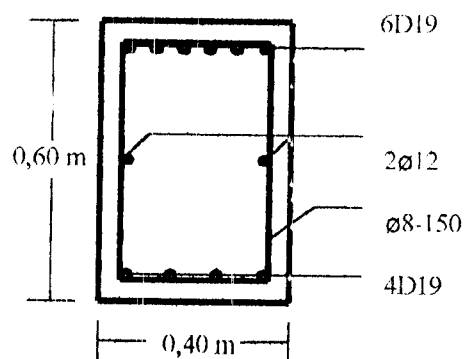

- Kebutuhan besi tulangan lapangan atas 6D19 untuk satu sloof :

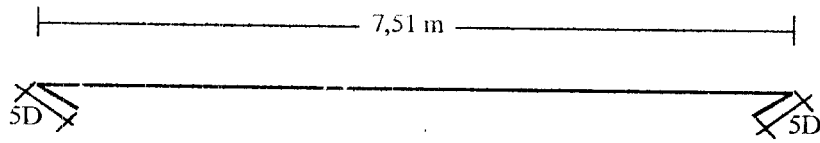

(panjang tulangan + kait) x jumlah tulangan lapangan

$$= ((7,51 + (2 \times 5 \times 0,019)) \times 2 = 15,40 \text{ m}$$

$$\text{Berat tulangan lapangan atas} = 15,40 \text{ m} \times 2,23 \text{ kg/m} = 34,34 \text{ kg}$$

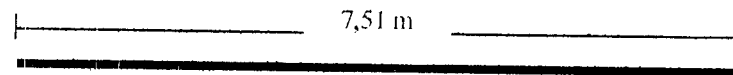

$$\text{panjang tulangan} \times \text{jumlah tulangan lapangan} = 7,51 \times 4 = 30,04 \text{ m}$$

$$\text{Berat tulangan lapangan atas} = 30,04 \text{ m} \times 2,23 \text{ kg/m} = 66,99 \text{ kg}$$

- Kebutuhan besi tulangan lapangan bawah 4D19 untuk satu sloof :

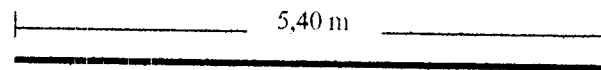

$$\text{panjang tulangan} \times \text{jumlah tulangan lapangan} = 5,40 \times 4 = 21,60 \text{ m}$$

$$\text{Berat tulangan lapangan bawah} = 21,60 \text{ m} \times 2,23 \text{ kg/m} = 48,17 \text{ kg}$$

- Berat total tulangan lapangan = $34,34 + 66,99 + 48,17 = 149,50 \text{ kg}$

* Tulangan susut 2P12

- Kebutuhan besi tulangan susut :

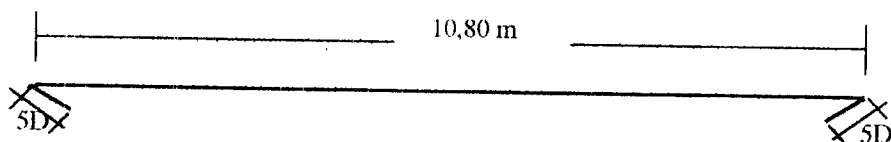

(panjang balok + 2 kait + perpanjangan) x jumlah tulangan susut :

$$= ((10,8 + (2 \times 5 \times 0,012) + (40 \times 0,012)) \times 2 = 22,56 \text{ m}$$

$$\text{Berat tulangan susut} = 22,56 \text{ m} \times 0,89 \text{ kg/m} = 20,08 \text{ kg}$$

- Berat total besi tulangan polos = berat tulangan begel + berat tulangan susut

$$= 51,06 + 20,08 = 71,14 \text{ kg}$$

- Berat total besi tulangan ulir = berat tulangan tumpuan + berat tulangan lapangan

$$= 119,40 + 149,50 = 268,90 \text{ kg}$$

$$\text{Volume beton} = 0,40 \times 0,60 \times 8,20 = 1,97 \text{ m}^3$$

Jadi dalam 1 m³ beton kebutuhan besi tulangan polos =

$$(1 / 1,97) \times 71,14 = 36,11 \text{ kg}$$

- Biaya penulangan untuk 1 kg besi polos :

$$1,1000 \text{ kg besi polos} \dots\dots\dots @ \text{ Rp. } 3.000,00 \quad = \text{ Rp. } 3.300,00$$

$$0,0200 \text{ kg kawat beton} \dots\dots\dots @ \text{ Rp. } 6.500,00 \quad = \text{ Rp. } \underline{130,00}$$

$$\text{Jumlah} \dots\dots\dots = \text{ Rp. } 3.430,00$$

$$\text{Upah borongan} \dots\dots\dots = \text{ Rp. } \underline{200,00}$$

$$\text{Jumlah (upah + bahan)} \dots\dots\dots = \text{ Rp. } 3.630,00$$

Tiap 1 m³ beton perlu besi tulangan polos 36,11 kg, jadi :

$$36,11 \text{ kg} \times \text{Rp. } 3.630,00 = \text{Rp. } 131.784,00$$

Jadi dalam 1 m³ beton kebutuhan besi tulangan ulir =

$$(1 / 1,97) \times 268,90 = 136,50 \text{ kg}$$

- Biaya penulangan untuk 1 kg besi ulir :

1,1000 kg besi ulir	@ Rp. 3.350,00	= Rp. 3.685,00
0,0200 kg kawat beton	@ Rp. 6.500,00	= <u>Rp. 130,00</u>
Jumlah		= Rp. 3.815,00
Upah borongan		= <u>Rp. 200,00</u>
Jumlah (upah + bahan)		= Rp. 4.015,00

Tiap 1 m³ beton perlu besi tulangan ulir 136,50 kg, jadi :

$$136,50 \text{ kg} \times \text{Rp. } 4.015,00 = \text{Rp. } 550.777,50$$

- Harga satuan pekerjaan penulangan = harga penulangan besi polos + harga

penulangan besi ulir

$$= \text{Rp. } 131.784,00 + \text{Rp. } 550.777,50$$

$$= \text{Rp. } 682.561,50$$

Untuk perhitungan kebutuhan besi tulangan balok sloof tipe yang lain, dapat dilihat pada lampiran 5 perhitungan kebutuhan besi tulangan pokok balok sloof, perhitungan kebutuhan besi tulangan begel balok sloof, disajikan pula rekap kebutuhan besi tulangan berdasarkan jenis besi yaitu rekapitulasi kebutuhan besi tulangan ulir balok sloof dan rekapitulasi kebutuhan besi tulangan polos balok sloof.

3. Bekisting

Kebutuhan bekisting untuk satu sloof = (2 x tinggi sloof) x panjang bersih sloof
 = (0,60 x 2) x 8,20 = 9,84 m²

Volume beton = 0,40 x 0,60 x 8,20 = 1,97 m³

Jadi dalam 1 m³ beton kebutuhan bekisting = (1 / 1,97) x 9,84 m² = 4,99 m²

- Biaya 1 m² bekisting :

0,3820 lbr multipleks 15mm.....	@ Rp. 60.000,00	= Rp. 22.920,00
0,0139 m ³ kayu bekisting	@ Rp. 1.700.000,00	= Rp. 23.630,00
0,2000 kg paku	@ Rp. 6.000,00	= Rp. 1.200,00
0,2000 ltr minyak pelumas	@ Rp. 12.500,00	= <u>Rp. 2.500,00</u>
Jumlah		= Rp. 50.250,00

Berdasarkan hitungan diatas, biaya bekisting untuk 1 m³ beton adalah :

1,9080 lbr multiplex 15mm.....	@ Rp. 60.000,00	= Rp. 57.240,00
0,0695 m ³ kayu bekisting	@ Rp.1.700.000,00	= Rp. 59.075,00
0,9989 kg paku	@ Rp. 6.000,00	= Rp. 5.993,40
0,9989 ltr minyak pelumas.....	@ Rp. 12.500,00	= <u>Rp. 12.486,25</u>
Jumlah		= Rp.134.794,65
Upah borongan : 4,99 m ² x Rp. 9.000,00		= <u>Rp. 44.910,00</u>
Total (upah + bahan)		= Rp.179.704,65
Harga satuan pekerjaan bekisting		= Rp.179.704,65

Catatan : - kayu bekisting menggunakan kayu kruing dengan asumsi bahwa bekisting dapat digunakan sebanyak 2 kali.

Untuk perhitungan volume bekisting balok sloof tipe yang lain, dapat dilihat pada lampiran 5 perhitungan volume bekisting dan volume beton balok sloof.

Harga satuan pekerjaan balok sloof tipe S1 (40/60) :

- Biaya cor	= Rp. 306.500,00
- Biaya penulangan.....	= Rp. 682.561,50
- Biaya bekisting.....	= <u>Rp. 179.704,65</u>
Jumlah	= Rp.1.168.766,15

Tabel 5.6 Harga Satuan Pekerjaan Balok Sloof Tipe S1

Uraian	Vol.	Sat.	Harga Satuan (Rp)	Analisa Harga Bhn (Rp)	Analisa Harga Upah (Rp)	Total Harga Analisa (Rp)
BAHAN						
Paku	1,00	kg	6.000,00	5.993,40		
Besi ulir	150,15	kg	3.350,00	503.002,50		
Besi polos	39,72	kg	3.000,00	119.160,00		
Multiplex (50%)	1,91	lbr	60.000,00	57.240,00		
Beton ready mix	1,00	m ³	274.000,00	274.000,00		
Kayu bekisting (50%)	0,07	m ³	1.700.000,00	59.075,00		
Bendrat	3,45	kg	6.500,00	22.425,00		
Minyak bekisting	1,00	ltr	12.500,00	12.486,25		
UPAH BORONGAN						
Cor ready mix	1,00	m ³	32.500,00		32.500,00	
Buat + stel besi	189,87	kg	200,00		37.974,00	
Bekisting	4,99	m ²	9.000,00		44.910,00	115.384,00
					Jumlah	1.168.766,15
					Dibulatkan	1.168.766,00

Balok sloof tipe S1 mempunyai volume beton 25,58 m³, maka :

Harga pekerjaan balok sloof tipe S1 = 25,58 m³ x Rp. 1.168.766,15

= Rp. 29.897.038,12

Pada lampiran 5 diberikan juga harga satuan pekerjaan tiap tipe sloof dan harga tiap pekerjaan sloof tipe yang lainnya.

5.2.6 Pekerjaan Beton Kolom

Kolom Lantai 1 Tipe K1 Ø850 mm

Kolom K1 adalah kolom berbentuk lingkaran dengan diameter 850 mm, tinggi kolom 4,95 m dengan begel berbentuk spiral sepanjang tinggi kolom.

Jumlah kolom tipe K1 = 2 buah

$$\begin{aligned} \text{Volume beton kolom K1} &= \left(\frac{1}{4} \pi d^2 \right) \times \text{tinggi kolom} \\ &= \left(\frac{1}{4} \pi \times 0,85^2 \right) \times 4,95 \\ &= 2,81 \text{ m}^3 \end{aligned}$$

$$\text{Volume beton total kolom tipe K1} = 2 \times 2,81 \text{ m}^3 = 5,62 \text{ m}^3.$$

Untuk perhitungan volume beton kolom dari lantai 1 sampai dengan atap tipe yang lain, dapat dilihat pada lampiran 6 perhitungan volume beton dan volume bekisting kolom.

1. Beton

- Biaya 1 m³ beton $f_c' 25 \text{ Mpa}$:

1 m ³ beton ready mix $f_c' 25 \text{ Mpa}$	= Rp. 274.000,00
Upah cor.....	= <u>Rp. 40.000,00</u>
Jumlah	= Rp. 314.000,00
Harga satuan pekerjaan pencoran beton	= Rp. 314.000,00

2. Besi Beton

Perhitungan kebutuhan besi:

* Tulangan pokok

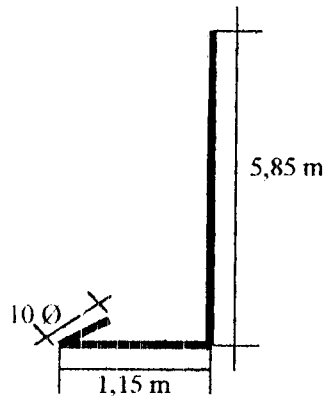

Elevasi lantai 1 = + 0,00 m

Elevasi lantai 2 = + 4,48 m

Jarak elevasi lantai 1 ke poer pile = 0,47 m

Tinggi poer pile = 0,90 m

Panjang besi = (elevasi lantai 2 – elevasi lantai 1) + jarak elevasi lantai 1 ke poer pile + tinggi poer pile

$$= (4,48 - 0,00) + 0,47 + 0,90 = 5,85 \text{ m}$$

Lebar poer pile = 2,40 m

Panjang besi tekuk = lebar poer pile – (2 x tebal selimut beton)

$$= 2,40 - (2 \times 0,05)$$

$$= 1,15 \text{ m}$$

Panjang kait = 10 x D25

$$= 10 \times 0,025$$

$$= 0,25 \text{ m}$$

Panjang tulangan pokok = panjang besi + panjang besi tekuk + panjang kait

$$= 5,85 + 1,15 + 0,25$$

$$= 7,25 \text{ m}$$

Banyak tulangan pokok = 36 buah

Berat besi tulangan D25 = 3,85 kg/m

Volume besi tulangan = (panjang tulangan pokok + perpanjangan) x banyak

$$\begin{aligned} & \text{tulangan x berat besi tulangan} \\ & = (7,25 + (40 \times 0,025)) \times 36 \times 3,85 \\ & = 1143,45 \text{ kg} \end{aligned}$$

Jadi dalam 1 m³ beton kebutuhan besi tulangan ulir =

$$(1 / 2,81) \times 1143,45 = 406,92 \text{ kg}$$

- Biaya penulangan untuk 1 kg besi ulir :

1,1000 kg besi ulir	@ Rp. 3.350,00	= Rp. 3.685,00
0,0200 kg kawat beton	@ Rp. 6.500,00	= <u>Rp. 130,00</u>
Jumlah		= Rp. 3.815,00
Upah borongan		= <u>Rp. 200,00</u>
Jumlah (upah + bahan)		= Rp. 4.015,00

Tiap 1 m³ beton perlu besi tulangan ulir 406,92 kg, jadi :

$$406,92 \text{ kg} \times \text{Rp. } 4.015,00 = \text{Rp. } 1.641.925,50$$

Untuk perhitungan kebutuhan besi tulangan pokok kolom tipe yang lain dari lantai 1 sampai dengan atap, dapat dilihat pada lampiran 6 perhitungan kebutuhan besi tulangan pokok kolom dan disajikan pula rekap kebutuhan besi tulangan berdasarkan jenis besi yaitu untuk tulangan pokok menggunakan besi ulir (D25), rekapitulasi kebutuhan besi tulangan ulir kolom.

* Begel spiral

Menggunakan besi P12 dengan jarak antar besi 100 mm.

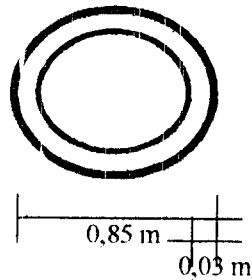

$$\begin{aligned} \text{Keliling kolom} &= \pi \times d \\ &= \pi \times 0,85 \\ &= 2,6703 \text{ m} \end{aligned}$$

$$\text{Keliling selimut kolom} = \pi \times d = \pi \times 0,03 = 0,0942 \text{ m}$$

$$\text{Diameter begel (} d' \text{)} = \frac{\text{keliling kolom}}{\text{keliling selimut kolom}}$$

$$= \frac{2,6703}{0,0942}$$

$$= 2,83 \text{ m}$$

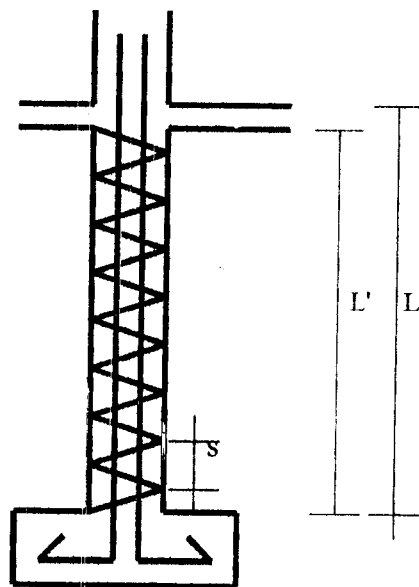

$$L = \text{tinggi kolom} = 5,23 \text{ m}$$

$$h \text{ balok} = 0,90 \text{ m}$$

$$L' = \text{tinggi kolom} - (\frac{1}{2}h \text{ balok})$$

$$= 5,23 - (\frac{1}{2} \times 0,90)$$

$$= 4,78 \text{ m}$$

$$\text{Panjang begel} = \frac{L'}{s} \sqrt{(3,14 \times d')^2 + s^2}$$

$$\begin{aligned} \text{Panjang begel} &= \frac{4,78}{0,1} \sqrt{(3,14 \times 2,58)^2 + 0,1^2} \\ &= 386,68 \text{ m} \end{aligned}$$

$$\begin{aligned} \text{Panjang begel seluruhnya} &= \text{panjang begel} + \text{perpanjangan} (40 \emptyset) \\ &= 386,68 + (40 \times 0,025) \\ &= 387,65 \text{ m} \end{aligned}$$

$$\text{Berat besi P12} = 0,89 \text{ kg/m}$$

$$\begin{aligned} \text{Volume begel} &= \text{panjang begel} \times \text{berat besi P12} \\ &= 387,68 \times 0,89 \\ &= 345,01 \text{ kg} \end{aligned}$$

Jadi dalam 1 m³ beton kebutuhan besi tulangan polos =

$$(1 / 2,81) \times 345,01 = 122,78 \text{ kg}$$

- Biaya penulangan untuk 1 kg besi polos :

1,1000 kg besi polos	@ Rp. 3.000,00	= Rp. 3.300,00
0,0200 kg kawat beton	@ Rp. 6.500,00	= <u>Rp. 130,00</u>
Jumlah		= Rp. 3.430,00
Upah borongan		= <u>Rp. 200,00</u>
Jumlah (upah + bahan)		= Rp. 3.630,00

Tiap 1 m³ beton perlu besi tulangan polos 122,78 kg, jadi :

$$122,78 \text{ kg} \times \text{Rp. } 3.630,00 = \text{Rp. } 448.182,00$$

Untuk perhitungan kebutuhan besi tulangan begel kolom tipe yang lain dari lantai 1 sampai dengan atap, dapat dilihat pada lampiran 6 perhitungan kebutuhan besi begel kolom dan untuk rekap kebutuhan besi tulangan berdasarkan jenis besi yaitu untuk tulangan begel menggunakan besi polos (P12 dan P10), rekapitulasi kebutuhan besi tulangan polos kolom.

- Harga satuan pekerjaan penulangan = harga penulangan besi polos + harga penulangan besi ulir
- $$= \text{Rp. } 1.641.925,50 + \text{Rp. } 448.182,00$$
- $$= \text{Rp. } 2.090.107,50$$

3. Bekisting

Karena profil kolom K1 lingkaran maka bekistingnya pun mengikuti bentuk dari profil kolom K1 dengan diameter 850 mm dan tinggi kolom 4,95 m. maka volume bekisting kolom tersebut = $\pi \times d \times \text{tinggi kolom}$

$$= \pi \times 0,85 \times 4,95$$

$$= 13,22 \text{ m}^2$$

Jadi dalam 1 m³ beton kebutuhan bekisting = $(1 / 2,81) \times 13,22 = 4,71 \text{ m}^2$

- Biaya 1 m² bekisting :

0,3820 lbr multipleks 15mm.....	@ Rp. 60.000,00	= Rp. 22.920,00
0,0139 m ³ kayu bekisting	@ Rp. 1.700.000,00	= Rp. 23.630,00
0,2000 kg paku	@ Rp. 6.000,00	= Rp. 1.200,00
0,2000 ltr minyak pelumas	@ Rp. 12.500,00	= Rp. 2.500,00
Jumlah		= Rp. 50.250,00

Berdasarkan hitungan diatas, biaya bekisting untuk 1 m³ beton adalah :

1,7992 lbr multipleks 15mm.....	@ Rp. 60.000,00	= Rp. 53.976,00
0,0655 m ³ kayu bekisting	@ Rp.1.700.000,00	= Rp. 55.675,00
0,9420 kg paku	@ Rp. 6.000,00	= Rp. 5.652,00
0,9420 ltr minyak pelumas.....	@ Rp. 12.500,00	= <u>Rp. 11.775,00</u>
Jumlah		= Rp. 127.078,00
Upah borongan : 4,71 m ² x Rp. 9.250,00		= <u>Rp. 43.567,50</u>
Total (upah + bahan)		= Rp. 170.645,50
Harga satuan pekerjaan bekisting		= Rp. 170.645,50

Catatan : - kayu bekisting menggunakan kayu kruing dengan asumsi bahwa bekisting dapat digunakan sebanyak 2 kali.

Untuk perhitungan volume bekisting kolom tipe yang lain dari lantai 1 sampai dengan lantai atap, dapat dilihat pada lampiran 6 perhitungan volume beton dan volume bekisting kolom.

4. Scaffolding / Perancah

Kebutuhan scaffolding tiap 1 m³ beton :

6 support.....	@ Rp. 9.500,00	= Rp. 57.000,00
6 U-head	@ Rp. 3.000,00	= Rp. 12.000,00
6 jack base	@ Rp. 3.000,00	= <u>Rp. 12.000,00</u>
	Jumlah	= Rp. 81.000,00
Upah pasang + bongkar : 4,71 m ² x Rp. 2.500,00.....		= <u>Rp. 11.775,00</u>
	Jumlah	= Rp. 92.775,00

Harga satuan pekerjaan kolom lantai 1 tipe K1 (Ø850) :

- Biaya cor	= Rp. 314.000,00
- Biaya penulangan.....	= Rp.2.090.107,50
- Biaya bekisting.....	= Rp. 170.645,50
- Scaffolding/perancah.....	= <u>Rp. 92.775,00</u>
Jumlah	= Rp. 2.667.528,00

Tabel 5.7 Harga Satuan Pekerjaan Kolom Lantai 1 Tipe K1

Uraian	Vol.	Sat.	Harga Satuan (Rp)	Analisis Harga Bhn (Rp)	Analisis Harga Upah (Rp)	Total Harga Analisis (Rp)
BAHAN						
Paku	0,94	kg	6.000,00	5.652,00		
Besi ulir	447,61	kg	3.350,00	1.499.493,50		
Besi polos	135,06	kg	3.000,00	405.180,00		
Multiplex (50%)	1,80	lbr	60.000,00	53.976,00		
Beton ready mix	1,00	m ³	274.000,00	274.000,00		
Kayu bekisting (50%)	0,07	m ³	1.700.000,00	55.675,00		
Bendrat	10,60	kg	6.500,00	68.900,00		
Minyak bekisting	0,94	ltr	12.500,00	11.775,00		
UPAH BORONGAN						2.374.651,50
Cor ready mix	1,00	m ³	40.000,00		40.000,00	
Buat + stel besi	582,67	kg	200,00		116.534,00	
Bekisting	4,71	m ²	9.250,00		43.567,50	
Pas+hongkar scaff.	4,71	m ²	2.500,00		11.775,00	
Scaffolding	6,00	set	13.500,00		81.000,00	
					Jumlah	2.667.528,00
					Dibulatkan	2.667.528,00

Kolom lantai 1 tipe K1 mempunyai volume beton $5,62 \text{ m}^3$, maka :

Harga pekerjaan kolom lantai 1 tipe K1 = $5,62 \text{ m}^3 \times \text{Rp. } 2.667.528,00$

= Rp. 14.991.507,36

Pada lampiran 6 diberikan juga harga satuan pekerjaan tiap tipe kolom dan harga tiap pekerjaan kolom tipe yang lainnya, dari lantai 1 sampai dengan atap.

Kolom Lantai 1 Tipe K3 750 x 750 mm

Kolom K3 ini berbentuk bujur sangkar dengan sisi-sisinya 750 x 750 mm, dan tinggi dari kolom K3 adalah 4,95 m.

Jumlah kolom tipe K3 = 2 buah

Volume beton = sisi x sisi x tinggi kolom

$$= 0,75 \times 0,75 \times 4,95$$

$$= 2,78 \text{ m}^3$$

$$\text{Volume beton total kolom tipe K3} = 2 \times 2,78 \text{ m}^3 = 5,57 \text{ m}^3$$

Untuk perhitungan volume beton kolom dari lantai 1 sampai dengan atap tipe yang lain, dapat dilihat pada lampiran 6 perhitungan volume beton dan volume bekisting kolom.

1. Beton

- Biaya 1m³ beton *fc'* 25 Mpa :

1 m³ beton ready mix *fc'* 25 Mpa = Rp. 274.000,00

Upah cor..... = Rp. 40.000,00

Jumlah = Rp. 314.000,00

Harga satuan pekerjaan pencoran beton = Rp. 314.000,00

2. Besi Beton

Perhitungan kebutuhan besi:

* Tulangan pokok

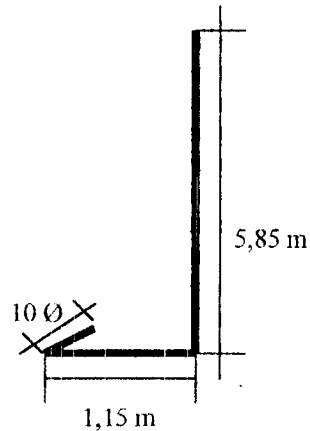

Elevasi lantai 1 = + 0,00 m

Elevasi lantai 2 = + 4,48 m

Jarak elevasi lantai 1 ke poer pile = 0,47 m

Tinggi poer pile = 0,90 m

Panjang besi = (elevasi lantai 2 – elevasi lantai 1) + jarak elevasi lantai 1 ke poer pile + tinggi poer pile

$$= (4,48 - 0,00) + 0,47 + 0,90 = 5,85 \text{ m}$$

Lebar poer pile = 2,40 m

Panjang besi tekuk = lebar poer pile – (2 x tebal selimut beton)

$$= 2,40 - (2 \times 0,05)$$

$$= 1,15 \text{ m}$$

Panjang kait = 10 x D25

$$= 10 \times 0,025$$

$$= 0,25 \text{ m}$$

Panjang tulangan pokok = panjang besi + panjang besi tekuk + panjang kait

$$= 5,85 + 1,15 + 0,25 = 7,25 \text{ m}$$

Banyak tulangan pokok = 28 buah

Berat besi tulangan D25 = 3,85 kg/m

$$\begin{aligned} \text{Volume besi tulangan} &= (\text{panjang tulangan pokok} + \text{perpanjangan}) \times \text{banyak} \\ &\quad \text{tulangan} \times \text{berat besi tulangan} \\ &= (7,25 + (40 \times 0,025)) \times 28 \times 3,85 \\ &= 889,35 \text{ kg} \end{aligned}$$

Jadi dalam 1 m³ beton kebutuhan besi tulangan ulir =

$$(1 / 2,78) \times 889,35 = 319,91 \text{ kg}$$

- Biaya penulangan untuk 1 kg besi ulir :

1,1000 kg besi ulir	@ Rp. 3.350,00	= Rp. 3.685,00
0,0200 kg kawat beton	@ Rp. 6.500,00	= <u>Rp. 130,00</u>
Jumlah		= Rp. 3.815,00
Upah borongan		= <u>Rp. 200,00</u>
Jumlah (upah + bahan)		= Rp. 4.015,00

Tiap 1 m³ beton perlu besi tulangan ulir 319,91 kg, jadi :

$$319,91 \text{ kg} \times \text{Rp. } 4.015,00 = \text{Rp. } 1.290.845,00$$

Untuk perhitungan kebutuhan besi tulangan pokok kolom tipe yang lain dari lantai 1 sampai dengan atap, dapat dilihat pada lampiran 6 perhitungan kebutuhan besi tulangan pokok kolom dan disajikan pula rekap kebutuhan besi tulangan berdasarkan jenis besi yaitu untuk tulangan pokok menggunakan besi ulir (D25), rekapitulasi kebutuhan besi tulangan ulir kolom.

* Begel

* Potongan A Besi Begel P10-80

- Begel Luar

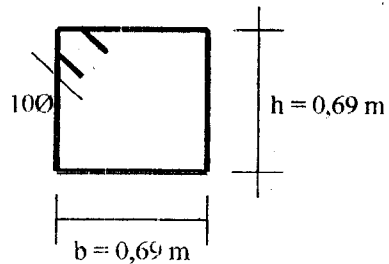

$$h \text{ begel} = h \text{ kolom} - (2 \times \text{tebal selimut kolom})$$

$$= 0,75 - (2 \times 0,03)$$

$$= 0,69 \text{ m}$$

$$b \text{ begel} = b \text{ kolom} - (2 \times \text{tebal selimut kolom})$$

$$= 0,75 - (2 \times 0,03)$$

$$= 0,69 \text{ m}$$

$$\text{Panjang kait} = 2 \times 10 \times P10$$

$$= 2 \times 10 \times 0,01$$

$$= 0,20 \text{ m}$$

$$\text{Panjang begel} = \text{keliling bujursangkar} + \text{panjang kait}$$

$$= (2 \times (0,69 + 0,69)) + 0,20$$

$$= 2,96 \text{ m}$$

$$\text{Tinggi kolom potongan A} = 1197,5 \text{ mm}$$

$$\text{Jarak antar begel} = 80 \text{ mm}$$

$$\text{Jumlah begel} = \text{tinggi kolom pot. A} / \text{jarak begel}$$

$$= 1197,5 / 80$$

$$= 14,97 \approx 15 \text{ buah}$$

$$= 15 + 1 = 16 \text{ buah}$$

$$\text{Berat besi P10} = 0,62 \text{ kg/m}$$

$$\begin{aligned}
 \text{Volume begel luar} &= \text{panjang begel} \times \text{jumlah begel} \times \text{berat begel} \\
 &= 2,96 \times 16 \times 0,62 \\
 &= 29,31 \text{ kg}
 \end{aligned}$$

- Begel Dalam Vertikal

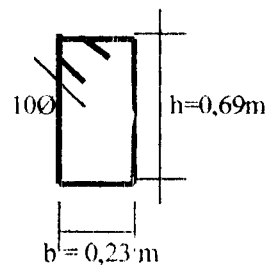

$$h \text{ begel} = h \text{ kolom} - (2 \times \text{tebal selimut kolom})$$

$$= 0,75 - (2 \times 0,03)$$

$$= 0,69 \text{ m}$$

$$b \text{ begel} = \frac{1}{3} (b \text{ kolom} - (2 \times \text{tebal selimut kolom}))$$

$$= \frac{1}{3} (0,75 - (2 \times 0,03))$$

$$= 0,23 \text{ m}$$

$$\text{Panjang kait} = 2 \times 10 \times P10$$

$$= 2 \times 10 \times 0,01$$

$$= 0,20 \text{ m}$$

$$\text{Panjang begel} = \text{keliling bujursangkar} + \text{panjang kait}$$

$$= (2 \times 0,23) + (2 \times 0,69) + 0,20$$

$$= 2,04 \text{ m}$$

$$\text{Tinggi kolom potongan A} = 1197,5 \text{ mm}$$

$$\text{Jarak antar begel} = 80 \text{ mm}$$

$$\text{Jumlah begel} = \text{tinggi kolom po. A} / \text{jarak begel}$$

$$= 1197,5 / 80$$

$$= 14,97 \approx 15 \text{ buah}$$

$$= 15 + 1 = 16 \text{ buah}$$

Berat besi P10 = 0,62 kg/m

Volume begel dalam = panjang begel x jumlah begel x berat begel

$$= 2,04 \times 16 \times 0,62$$

$$= 20,20 \text{ kg}$$

- Begel Dalam Horizontal

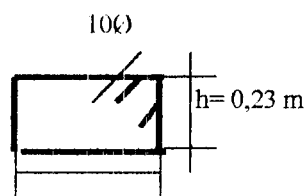

$$b = 0,23 \text{ m}$$

$$h \text{ begel} = \frac{1}{3} (h \text{ kolom} - (2 \times \text{tebal selimut kolom}))$$

$$= \frac{1}{3} (0,75 - (2 \times 0,03))$$

$$= 0,23 \text{ m}$$

$$b \text{ begel} = b \text{ kolom} - (2 \times \text{tebal selimut kolom})$$

$$= 0,75 - (2 \times 0,03)$$

$$= 0,69 \text{ m}$$

Panjang kait = 2 x 10 x P10

$$= 2 \times 10 \times 0,01$$

$$= 0,20 \text{ m}$$

Panjang begel = keliling bujursangkar + panjang kait

$$= (2 \times 0,23) + (2 \times 0,69) + 0,20$$

$$= 2,04 \text{ m}$$

Tinggi kolom potongan A = 1197,5 mm

Jarak antar begel = 80 mm

Jumlah begel = tinggi kolom pot. A / jarak begel

$$= 1197,5 / 80$$

$$= 14,97 \approx 15 + 1 = 16 \text{ buah}$$

Berat besi P10 = 0,62 kg/m

$$\begin{aligned} \text{Volume begel dalam} &= \text{panjang begel} \times \text{jumlah begel} \times \text{berat begel} \\ &= 2,04 \times 16 \times 0,62 \\ &= 20,20 \text{ kg} \end{aligned}$$

$$\begin{aligned} \text{Volume begel kolom potongan A} &= \text{Volume begel luar} + \text{volume begel dalam} \\ &\quad \text{vertikal} + \text{volume begel dalam horisontal} \\ &= 29,31 + 20,20 + 20,20 \\ &= 69,71 \text{ kg} \end{aligned}$$

* Potongan B Besi Begel P10-150

- Begel Luar

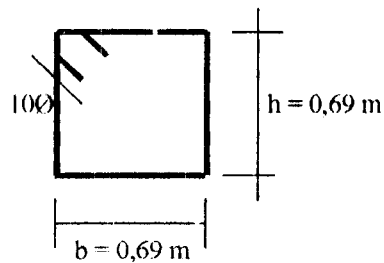

$$\begin{aligned} h \text{ begel} &= h \text{ kolom} - (2 \times \text{tebal selimut kolom}) \\ &= 0,75 - (2 \times 0,03) \\ &= 0,69 \text{ m} \\ b \text{ begel} &= b \text{ kolom} - (2 \times \text{tebal selimut kolom}) \\ &= 0,75 - (2 \times 0,03) \\ &= 0,69 \text{ m} \end{aligned}$$

$$\begin{aligned} \text{Panjang kait} &= 2 \times 10 \times P10 \\ &= 2 \times 10 \times 0,01 \\ &= 0,20 \text{ m} \end{aligned}$$

$$\begin{aligned} \text{Panjang begel} &= \text{keliling bujursangkar} + \text{panjang kait} \\ &= (2 \times (0,69 + 0,69)) + 0,20 \\ &= 2,96 \text{ m} \end{aligned}$$

Tinggi kolom potongan B = 2385 mm

Jarak antar begel = 150 mm

Jumlah begel = tinggi kolom pot. B / jarak begel

$$= 2385 / 150$$

$$= 15,9 \approx 16 \text{ buah}$$

$$= 16 + 1 = 17 \text{ buah}$$

Berat besi P10 = 0,62 kg/m

Volume begel luar = panjang begel x jumlah begel x berat begel

$$= 2,96 \times 17 \times 0,62$$

$$= 31,01 \text{ kg}$$

Volume begel kolom potongan B = Volume begel luar

$$= 31,01 \text{ kg}$$

* Potongan C Besi Begel P10-100

- Begel Luar

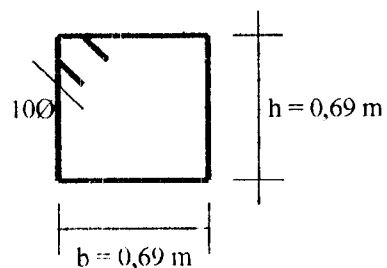

$$h \text{ begel} = h \text{ kolom} - (2 \times \text{tebal selimut kolom})$$

$$= 0,75 - (2 \times 0,03)$$

$$= 0,69 \text{ m}$$

$$b \text{ begel} = b \text{ kolom} - (2 \times \text{tebal selimut kolom})$$

$$= 0,75 - (2 \times 0,03)$$

$$= 0,69 \text{ m}$$

Panjang kait = 2 x 10 x P10

$$= 2 \times 10 \times 0,01 = 0,20 \text{ m}$$

$$\begin{aligned} \text{Panjang begel} &= \text{keliling bujursangkar} + \text{panjang kait} \\ &= (2 \times (0,69 + 0,69)) + 0,20 = 2,96 \text{ m} \end{aligned}$$

$$\text{Tinggi kolom potongan C} = 1247,5 \text{ mm}$$

$$\text{Jarak antar begel} = 100 \text{ mm}$$

$$\begin{aligned} \text{Jumlah begel} &= \text{tinggi kolom pot. C} / \text{jarak begel} \\ &= 1247,5 / 100 \\ &= 12,475 \approx 13 \text{ buah} \\ &= 13 + 1 = 14 \text{ buah} \end{aligned}$$

$$\text{Berat besi P10} = 0,62 \text{ kg/m}$$

$$\begin{aligned} \text{Volume begel luar} &= \text{panjang begel} \times \text{jumlah begel} \times \text{berat begel} \\ &= 2,96 \times 14 \times 0,62 = 24,73 \text{ kg} \end{aligned}$$

- Begel Dalam Vertikal

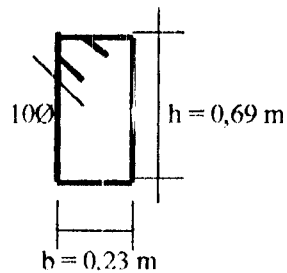

$$\begin{aligned} h \text{ begel} &= h \text{ kolom} - (2 \times \text{tebal selimut kolom}) \\ &= 0,75 - (2 \times 0,03) \\ &= 0,69 \text{ m} \end{aligned}$$

$$\begin{aligned} b \text{ begel} &= \frac{1}{3} (b \text{ kolom} - (2 \times \text{tebal selimut kolom})) \\ &= \frac{1}{3} (0,75 - (2 \times 0,03)) \\ &= 0,23 \text{ m} \end{aligned}$$

$$\begin{aligned} \text{Panjang kait} &= 2 \times 10 \times \text{P10} \\ &= 2 \times 10 \times 0,01 \\ &= 0,20 \text{ m} \end{aligned}$$

Panjang begel = keliling bujursangkar + panjang kait

$$= (2 \times 0,23) + (2 \times 0,69) + 0,20$$

$$= 2,04 \text{ m}$$

Tinggi kolom potongan C = 1247,5 mm

Jarak antar begel = 100 mm

Jumlah begel = tinggi kolom pot. C / jarak begel

$$= 1247,5 / 100$$

$$= 12,475 \approx 13 \text{ buah}$$

$$= 13 + 1 = 14 \text{ buah}$$

Berat besi P10 = 0,62 kg/m

Volume begel dalam = panjang begel x jumlah begel x berat begel

$$= 2,04 \times 14 \times 0,62 = 17,04 \text{ kg}$$

- Begel Dalam Horizontal

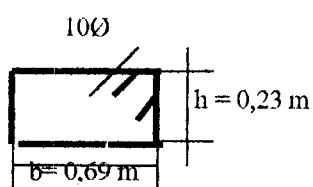

$$h \text{ begel} = \frac{1}{3} (h \text{ kolom} - (2 \times \text{tebal selimut kolom}))$$

$$= \frac{1}{3} (0,75 - (2 \times 0,03))$$

$$= 0,23 \text{ m}$$

$$b \text{ begel} = b \text{ kolom} - (2 \times \text{tebal selimut kolom})$$

$$= 0,75 - (2 \times 0,03)$$

$$= 0,69 \text{ m}$$

Panjang kait = 2 x 10 x P10

$$= 2 \times 10 \times 0,01$$

$$= 0,20 \text{ m}$$

$$\begin{aligned}
 \text{Panjang begel} &= \text{keliling bujursangkar} + \text{panjang kait} \\
 &= (2 \times 0,23) + (2 \times 0,69) + 0,20 \\
 &= 2,04 \text{ m}
 \end{aligned}$$

$$\text{Tinggi kolom potongan C} = 1247,5 \text{ mm}$$

$$\text{Jarak antar begel} = 100 \text{ mm}$$

$$\begin{aligned}
 \text{Jumlah begel} &= \text{tinggi kolom pot. C} / \text{jarak begel} \\
 &= 1247,5 / 100 \\
 &= 12,475 \approx 13 \text{ buah} \\
 &= 13 + 1 = 14 \text{ buah}
 \end{aligned}$$

$$\text{Berat besi P10} = 0,62 \text{ kg/m}$$

$$\begin{aligned}
 \text{Volume begel dalam} &= \text{panjang begel} \times \text{jumlah begel} \times \text{berat begel} \\
 &= 2,04 \times 14 \times 0,62 \\
 &= 17,04 \text{ kg}
 \end{aligned}$$

$$\begin{aligned}
 \text{Volume begel kolom potongan C} &= \text{Volume begel luar} + \text{volume begel dalam} \\
 &\quad \text{vertikal} + \text{volume begel dalam horisontal} \\
 &= 24,73 + 17,04 + 17,04 \\
 &= 58,81 \text{ kg}
 \end{aligned}$$

$$\begin{aligned}
 \text{Volume begel kolom K3} &= \text{volume begel pot A} + \text{volume begel pot B} + \text{volume} \\
 &\quad \text{begel pot C} \\
 &= 69,71 + 31,01 + 58,81 = 159,53 \text{ kg}
 \end{aligned}$$

$$\text{Volume total tulangan begel (besi polos)} = 159,53 \text{ kg}$$

$$\text{Jadi dalam } 1 \text{ m}^3 \text{ beton kebutuhan besi tulangan polos} =$$

$$(1 / 2,78) \times 159,53 = 57,38 \text{ kg}$$

- Biaya penulangan untuk 1 kg besi polos :

1,1000 kg besi polos	@ Rp. 3.000,00	= Rp. 3.300,00
0,0200 kg kawat beton	@ Rp. 6.500,00	= Rp. 130,00
Jumlah		= Rp. 3.430,00
Upah borongan		= Rp. 200,00
Jumlah (upah + bahan)		= Rp. 3.630,00

Tiap 1 m³ beton perlu besi tulangan polos 57,38 kg, jadi :

$$57,38 \text{ kg} \times \text{Rp. } 3.630,00 = \text{Rp. } 209.459,00$$

Untuk perhitungan kebutuhan besi tulangan begel kolom tipe yang lain dari lantai 1 sampai dengan atap, dapat dilihat pada lampiran 6 perhitungan kebutuhan besi begel kolom dan untuk rekap kebutuhan besi tulangan berdasarkan jenis besi yaitu untuk tulangan begel menggunakan besi polos (P12 dan P10), rekapitulasi kebutuhan besi tulangan polos kolom.

- Harga satuan pekerjaan penulangan = harga penulangan besi polos + harga penulangan besi ulir

$$\text{Rp. } 1.290.845,00 + \text{Rp. } 209.459,00$$

$$= \text{Rp. } 1.500.304,00$$

3. Bekisting

Bentuk dari bekisting kolom K3 ini mengikuti dari bentuk kolomnya yaitu berbentuk bujur sangkar dengan dimensi yang sama 750 x 750 mm dan tinggi 4,95 m. Volume dari bekistingnya adalah:

$$\begin{aligned}
 \text{Volume bekisting} &= \text{Keliling bujur sangkar} \times \text{tinggi kolom} \\
 &= ((2 \times 0,75) + (2 \times 0,75)) \times 4,95 \\
 &= 14,85 \text{ m}^2
 \end{aligned}$$

Jadi dalam 1 m³ beton kebutuhan bekisting = (1 / 2,78) x 14,85 = 5,333 m²

- Biaya 1 m² bekisting :

0,3820 lbr multipleks 15mm.....	@ Rp. 60.000,00	= Rp. 22.920,00
0,0139 m ³ kayu bekisting	@ Rp. 1.700.000,00	= Rp. 23.630,00
0,2000 kg paku	@ Rp. 6.000,00	= Rp. 1.200,00
0,2000 ltr minyak pelumas	@ Rp. 12.500,00	= <u>Rp. 2.500,00</u>
Jumlah		= Rp. 50.250,00

Berdasarkan hitungan diatas, biaya bekisting untuk 1 m³ beton adalah :

2,0372 lbr multipleks 15mm.....	@ Rp. 60.000,00	= Rp. 40.743,59
0,0741 m ³ kayu bekisting	@ Rp. 1.700.000,00	= Rp. 41.989,58
1,0666 kg paku	@ Rp. 6.000,00	= Rp. 6.399,60
1,0666 ltr minyak pelumas.....	@ Rp. 12.500,00	= <u>Rp. 13.332,50</u>
Jumlah		= Rp. 102.465,27
Upah borongan : 5,333 m ² x Rp. 9.250,00		= <u>Rp. 49.330,25</u>
Total (upah + bahan)		= Rp. 151.795,52
Harga satuan pekerjaan bekisting		= Rp. 151.795,52

Catatan : - kayu bekisting menggunakan kayu kruing dengan asumsi bahwa bekisting dapat digunakan sebanyak 3 kali dan terdapat kenaikan biaya 10% pada tiap lantainya untuk perbaikan bekisting.

Untuk perhitungan volume bekisting kolom tipe yang lain dari lantai 1 sampai dengan lantai atap, dapat dilihat pada lampiran 6 perhitungan volume beton dan volume bekisting kolom.

4. Scaffolding / Perancah

Kebutuhan scaffolding tiap 1 m³ beton :

6 support.....	@ Rp. 9.500,00	= Rp. 57.000,00
6 U-head.....	@ Rp. 3.000,00	= Rp. 12.000,00
6 jack base.....	@ Rp. 3.000,00	= <u>Rp. 12.000,00</u>
	Jumlah	= Rp. 81.000,00
Upah pasang + bongkar : 5,333 m ² x Rp. 2.500,00.....		= <u>Rp. 13.332,50</u>
	Jumlah	= Rp. 94.332,50

Harga satuan pekerjaan kolom lantai 1 tipe K3 (75/75) :

- Biaya cor	= Rp. 314.000,00
- Biaya penulangan.....	= Rp.1.500.304,00
- Biaya bekisting.....	= Rp. 151.795,52
- Scaffolding/perancah.....	= <u>Rp. 94.332,50</u>
	Jumlah = Rp. 2.060.432,02

Tabel 5.8 Harga Satuan Pekerjaan Kolom Lantai 1 Tipe K3

Uraian	Vol.	Sat.	Harga Satuan (Rp)	Analisis Harga Bahan (Rp)	Analisis Harga Upah (Rp)	Total Harga Analisis (Rp)
BAHAN						
Paku	1,07	kg	6.000,00	6.399,60		
Besi ulir	351,90	kg	3.350,00	1.178.865,00		
Besi polos	63,12	kg	3.000,00	189.360,00		
Multipleks 15mm(33,333%)	2,04	lbr	60.000,00	40.742,59		
Beton ready mix	1,00	m ³	274.000,00	274.000,00		
Kayu bekisting (33,333%)	0,07	m ³	1.700.000,00	41.989,58		
Bendrat	7,55	kg	6.500,00	49.075,00		
Minyak bekisting	1,07	litr	12.500,00	13.332,50		1.793.765,27
UPAH BORONGAN						
Cor ready mix	1,00	m ³	40.000,00		40.000,00	
Buat + stel besi	415,02	kg	200,00		83.004,00	
Bekisting	5,33	m ²	9.250,00		49.330,25	
Pas+bongkar scaff.	5,33	m ²	2.500,00		13.332,50	
Scaffolding	6,00	set	13.500,00		81.000,00	266.666,75
					Jumlah	2.060.432,02
					Dibulatkan	2.060.432,00

Kolom lantai 1 tipe K3 mempunyai volume beton 5,57 m³, maka :

Harga pekerjaan kolom lantai 1 tipe K3 = 5,57 m³ x Rp. 2.060.432,02

= Rp 11.476.606,35

Pada lampiran 6 diberikan juga harga satuan pekerjaan tiap tipe kolom dan harga tiap pekerjaan kolom tipe yang lainnya, dari lantai 1 sampai dengan atap.

Kolom Lantai 1 Tipe KL1 L400 x650 mm

Kolom KL1 adalah kolom yang mempunyai bentuk L, dengan dimensi kolom L 400x650mm dan tinggi kolom 5,20 m. Jumlah kolom tipe KL1 = 6 buah.

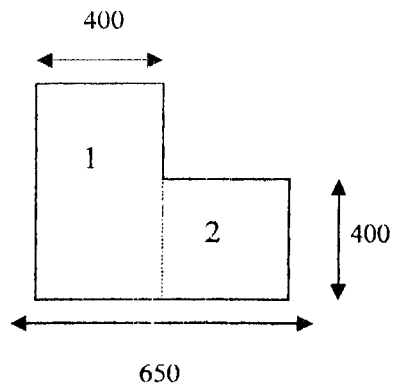

$$\text{Luas 1} = 0,40 \times 0,65 = 0,26 \text{ m}^2$$

$$\begin{aligned} \text{Luas 2} &= 0,25 \times 0,40 = 0,10 \text{ m}^2 + \\ &0,36 \text{ m}^2 \end{aligned}$$

Volume beton = luas x tinggi kolom

$$= 0,36 \times 5,20$$

$$= 1,87 \text{ m}^3$$

Volume beton total kolom tipe KL1 = $6 \times 1,87 \text{ m}^3 = 11,23 \text{ m}^3$

Untuk perhitungan volume beton kolom dari lantai 1 sampai dengan atap tipe yang lain, dapat dilihat pada lampiran 6 perhitungan volume beton dan volume bekisting kolom.

1. Beton

- Biaya 1 m^3 beton $f_c' 25 \text{ Mpa}$:

1 m^3 beton ready mix $f_c' 25 \text{ Mpa}$ = Rp. 274.000,00

Upah cor..... = Rp. 40.000,00

Jumlah = Rp. 314.000,00

Harga satuan pekerjaan pencoran beton = Rp. 314.000,00

Banyak tulangan pokok = 24 buah

Berat besi tulangan D25 = 3,85 kg/m

$$\begin{aligned} \text{Volume besi tulangan} &= (\text{panjang tulangan pokok} + \text{perpanjangan}) \times \text{banyak} \\ &\quad \text{tulangan} \times \text{berat besi tulangan} \\ &= (7,015 + (40 \times 0,025)) \times 24 \times 3,85 \\ &= 740,59 \text{ kg} \end{aligned}$$

Jadi dalam 1 m³ beton kebutuhan besi tulangan ulir =

$$(1 / 1,87) \times 740,59 = 396,04 \text{ kg}$$

- Biaya penulangan untuk 1 kg besi ulir :

1,1000 kg besi ulir	@ Rp. 3.350,00	= Rp. 3.685,00
0,0200 kg kawat beton	@ Rp. 6.500,00	= <u>Rp. 130,00</u>
Jumlah		= Rp. 3.815,00
Upah borongan		= <u>Rp. 200,00</u>
Jumlah (upah + bahan)		= Rp. 4.015,00

Tiap 1 m³ beton perlu besi tulangan ulir 396,04 kg, jadi :

$$396,04 \text{ kg} \times \text{Rp. } 4.015,00 = \text{Rp. } 1.598.002,00$$

Untuk perhitungan kebutuhan besi tulangan pokok kolom tipe yang lain dari lantai 1 sampai dengan atap, dapat dilihat pada lampiran 6 perhitungan kebutuhan besi tulangan pokok kolom dan disajikan pula rekap kebutuhan besi tulangan berdasarkan jenis besi yaitu untuk tulangan pokok menggunakan besi ulir (D25), rekapitulasi kebutuhan besi tulangan ulir kolom.

* Begel

* Potongan A besi begel P10-80

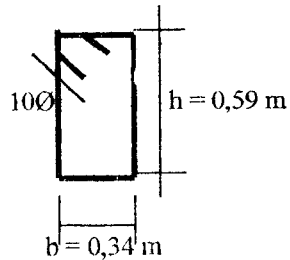

$$h \text{ begel} = h \text{ kolom} - (2 \times \text{tebal selimut kolom})$$

$$= 0,65 - (2 \times 0,03)$$

$$= 0,59 \text{ m}$$

$$b \text{ begel} = b \text{ kolom} - (2 \times \text{tebal selimut kolom})$$

$$= 0,40 - (2 \times 0,03)$$

$$= 0,34 \text{ m}$$

$$\text{Panjang kait} = 2 \times 10 \times P10$$

$$= 2 \times 10 \times 0,01$$

$$= 0,20 \text{ m}$$

$$\text{Panjang begel} = \text{keliling bujursangkar} + \text{panjang kait}$$

$$= (2 \times 0,34) + (2 \times 0,59) + 0,20$$

$$= 2,06 \text{ m}$$

$$\text{Tinggi kolom potongan A} = 1197,5 \text{ mm}$$

$$\text{Jarak antar begel} = 80 \text{ mm}$$

$$\text{Jumlah begel} = \text{tinggi kolom pot. A} / \text{jarak begel}$$

$$= 1197,5 / 80$$

$$= 14,969 \approx 15 \text{ buah}$$

$$= 15 + 1 = 16 \text{ buah}$$

$$\text{Berat besi P10} = 0,62 \text{ kg/m}$$

$$\text{Volume begel dalam} = \text{panjang begel} \times \text{jumlah begel} \times \text{berat begel}$$

$$= 2,06 \times 16 \times 0,62 = 20,40 \text{ kg}$$

- Begel Horizontal

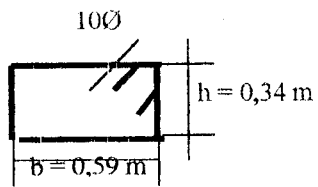

$$\begin{aligned}
 h \text{ begel} &= h \text{ kolom} - (2 \times \text{tebal selimut kolom}) \\
 &= 0,40 - (2 \times 0,03) \\
 &= 0,34 \text{ m}
 \end{aligned}$$

$$\begin{aligned}
 b \text{ begel} &= b \text{ kolom} - (2 \times \text{tebal selimut kolom}) \\
 &= 0,65 - (2 \times 0,03) \\
 &= 0,59 \text{ m}
 \end{aligned}$$

$$\begin{aligned}
 \text{Panjang kait} &= 2 \times 10 \times P10 \\
 &= 2 \times 10 \times 0,01 \\
 &= 0,20 \text{ m}
 \end{aligned}$$

$$\begin{aligned}
 \text{Panjang begel} &= \text{keliling bujursangkar} + \text{panjang kait} \\
 &= (2 \times 0,34) + (2 \times 0,59) + 0,20 \\
 &= 2,06 \text{ m}
 \end{aligned}$$

$$\text{Tinggi kolom potongan A} = 1197,5 \text{ mm}$$

$$\text{Jarak antar begel} = 80 \text{ mm}$$

$$\begin{aligned}
 \text{Jumlah begel} &= \text{tinggi kolom pot. A} / \text{jarak begel} \\
 &= 1197,5 / 80 \\
 &= 14,969 \approx 15 \text{ buah} \\
 &= 15 + 1 = 16 \text{ buah}
 \end{aligned}$$

$$\text{Berat besi P10} = 0,62 \text{ kg/m}$$

$$\begin{aligned}
 \text{Volume begel} &= \text{panjang begel} \times \text{jumlah begel} \times \text{berat begel} \\
 &= 2,06 \times 16 \times 0,62 \\
 &= 20,40 \text{ kg}
 \end{aligned}$$

* Potongan B besi begel P10-150

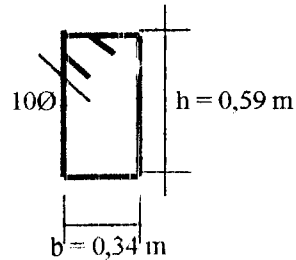

$$\begin{aligned} h \text{ begel} &= h \text{ kolom} - (2 \times \text{tebal selimut kolom}) \\ &= 0,65 - (2 \times 0,03) \\ &= 0,59 \text{ m} \end{aligned}$$

$$\begin{aligned} b \text{ begel} &= b \text{ kolom} - (2 \times \text{tebal selimut kolom}) \\ &= 0,40 - (2 \times 0,03) \\ &= 0,34 \text{ m} \end{aligned}$$

$$\begin{aligned} \text{Panjang kait} &= 2 \times 10 \times P10 \\ &= 2 \times 10 \times 0,01 \\ &= 0,20 \text{ m} \end{aligned}$$

$$\begin{aligned} \text{Panjang begel} &= \text{keliling bujursangkar} + \text{panjang kait} \\ &= (2 \times 0,34) + (2 \times 0,59) + 0,20 \\ &= 2,06 \text{ m} \end{aligned}$$

Tinggi kolom potongan B = 2435 mm

Jarak antar begel = 150 mm

$$\begin{aligned} \text{Jumlah begel} &= \text{tinggi kolom pot. B} / \text{jarak begel} \\ &= 2435 / 150 \\ &= 16,233 \approx 16 \text{ buah} \\ &= 16 + 1 = 17 \text{ buah} \end{aligned}$$

Berat besi P10 = 0,62 kg/m

$$\begin{aligned} \text{Volume begel} &= \text{panjang begel} \times \text{jumlah begel} \times \text{berat beugel} \\ &= 2,06 \times 17 \times 0,62 \\ &= 22,01 \text{ kg} \end{aligned}$$

- Begel Horizontal

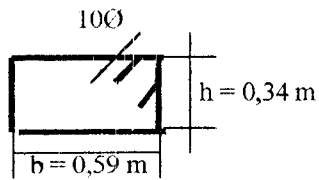

$$\begin{aligned}
 h \text{ begel} &= h \text{ kolom} - (2 \times \text{tebal selimut kolom}) \\
 &= 0,40 - (2 \times 0,03) \\
 &= 0,34 \text{ m}
 \end{aligned}$$

$$\begin{aligned}
 b \text{ begel} &= b \text{ kolom} - (2 \times \text{tebal selimut kolom}) \\
 &= 0,65 - (2 \times 0,03) \\
 &= 0,59 \text{ m}
 \end{aligned}$$

$$\begin{aligned}
 \text{Panjang kait} &= 2 \times 10 \times P10 \\
 &= 2 \times 10 \times 0,01 \\
 &= 0,20 \text{ m}
 \end{aligned}$$

$$\begin{aligned}
 \text{Panjang begel} &= \text{keliling bujursangkar} + \text{panjang kait} \\
 &= (2 \times 0,34) + (2 \times 0,59) + 0,20 \\
 &= 2,06 \text{ m}
 \end{aligned}$$

$$\text{Tinggi kolom potongan B} = 2435 \text{ mm}$$

$$\text{Jarak antar begel} = 150 \text{ mm}$$

$$\begin{aligned}
 \text{Jumlah begel} &= \text{tinggi kolom pot. B} / \text{jarak begel} \\
 &= 2435 / 150 \\
 &= 16,233 \approx 16 \text{ buah} \\
 &= 16 + 1 = 17 \text{ buah}
 \end{aligned}$$

$$\text{Berat besi P10} = 0,62 \text{ kg/m}$$

$$\begin{aligned}
 \text{Volume begel} &= \text{panjang begel} \times \text{jumlah begel} \times \text{berat begel} \\
 &= 2,06 \times 17 \times 0,62 \\
 &= 22,01 \text{ kg}
 \end{aligned}$$

- Begel Horizontal

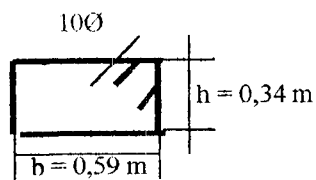

$$\begin{aligned}
 h \text{ begel} &= \text{kolom} - (2 \times \text{tebal selimut kolom}) \\
 &= 0,40 - (2 \times 0,03) \\
 &= 0,34 \text{ m}
 \end{aligned}$$

$$\begin{aligned}
 b \text{ begel} &= b \text{ kolom} - (2 \times \text{tebal selimut kolom}) \\
 &= 0,65 - (2 \times 0,03) \\
 &= 0,59 \text{ m}
 \end{aligned}$$

$$\begin{aligned}
 \text{Panjang kait} &= 2 \times 10 \times P10 \\
 &= 2 \times 10 \times 0,01 \\
 &= 0,20 \text{ m}
 \end{aligned}$$

$$\begin{aligned}
 \text{Panjang begel} &= \text{keliling bujursangkar} + \text{panjang kait} \\
 &= (2 \times 0,34) + (2 \times 0,59) + 0,20 \\
 &= 2,06 \text{ m}
 \end{aligned}$$

$$\text{Tinggi kolom potongan C} = 1197,5 \text{ mm}$$

$$\text{Jarak antar begel} = 100 \text{ mm}$$

$$\begin{aligned}
 \text{Jumlah begel} &= \text{tinggi kolom pot. C} / \text{jarak begel} \\
 &= 1197,5 / 100 \\
 &= 11,975 \approx 12 \text{ buah} \\
 &= 12 + 1 = 13 \text{ buah}
 \end{aligned}$$

$$\text{Berat besi P10} = 0,62 \text{ kg/m}$$

$$\begin{aligned}
 \text{Volume begel} &= \text{panjang begel} \times \text{jumlah begel} \times \text{berat begel} \\
 &= 2,06 \times 13 \times 0,62 \\
 &= 16,57 \text{ kg}
 \end{aligned}$$

$$\begin{aligned}
 \text{Volume begel total} &= \text{Volume pot A} + \text{volume pot B} + \text{volume pot C} \\
 &= (2 \times 20,24) + (2 \times 22,01) + (2 \times 16,57) \\
 &= 117,95 \text{ kg}
 \end{aligned}$$

$$\text{Volume total tulangan begel (besi polos)} = 117,95 \text{ kg}$$

Jadi dalam 1 m³ beton kebutuhan besi tulangan polos =

$$(1 / 1,87) \times 117,95 = 63,07 \text{ kg}$$

- Biaya penulangan untuk 1 kg besi polos :

1,1000 kg besi polos	@ Rp. 3.000,00	= Rp. 3.300,00
0,0200 kg kawat beton	@ Rp. 6.500,00	= Rp. <u>130,00</u>
Jumlah		= Rp. 3.430,00
Upah borongan		= Rp. <u>200,00</u>
Jumlah (upah + bahan)		= Rp. 3.630,00

Tiap 1 m³ beton perlu besi tulangan polos 63,07 kg, jadi :

$$63,07 \text{ kg} \times \text{Rp. } 3.630,00 = \text{Rp. } 230.206,00$$

Untuk perhitungan kebutuhan besi tulangan begel kolom tipe yang lain dari lantai 1 sampai dengan atap, dapat dilihat pada lampiran 6 perhitungan kebutuhan besi begel kolom dan untuk rekap kebutuhan besi tulangan berdasarkan jenis besi yaitu untuk tulangan begel menggunakan besi polos (P12 dan P10), rekapitulasi kebutuhan besi tulangan polos kolom.

$$\begin{aligned}
 - \text{ Harga satuan pekerjaan penulangan} &= \text{ harga penulangan besi polos} + \text{ harga} \\
 &\quad \text{penulangan besi ulir} \\
 &= \text{Rp. 1.598.002,00} + \text{Rp. 230.206,00} \\
 &= \text{Rp. 1.828.208,00}
 \end{aligned}$$

3. Bekisting

Bentuk bekisting kolom KL1 ini mengikuti dari bentuk kolomnya yaitu berbentuk L dengan dimensi yang sama L 400 x 650 mm dan tinggi 5,20 m.

Volume dari bekistingnya adalah:

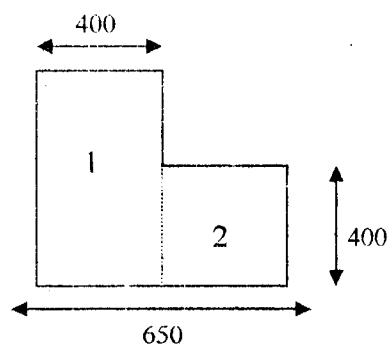

$$\text{Keliling 1} = 0,4 + 0,25 + 0,4 + 0,65 = 1,7 \text{ m}$$

$$\begin{aligned}
 \text{Keliling 2} &= 0,4 + 0,4 + 0,25 + 0,25 = 1,3 \text{ m} + \\
 &\quad \underline{\hspace{1.5cm}} \\
 &= 3,0 \text{ m}
 \end{aligned}$$

Volume bekisting = keliling total x tinggi kolom

$$= 3,0 \times 5,20$$

$$= 15,60 \text{ m}^2$$

Jadi dalam 1 m³ beton kebutuhan bekisting = (1 / 1,87) x 15,60 = 8,327 m²

- Biaya 1 m² bekisting :

0,3820 lbr multipleks 15mm.....	@ Rp. 60.000,00	= Rp. 22.920,00
0,0139 m ³ kayu bekisting	@ Rp. 1.700.000,00	= Rp. 23.630,00
0,2000 kg paku	@ Rp. 6.000,00	= Rp. 1.200,00
0,2000 ltr minyak pelumas	@ Rp. 12.500,00	= <u>Rp. 2.500,00</u>
Jumlah		= Rp. 50.250,00

Berdasarkan hitungan diatas, biaya bekisting untuk 1 m³ beton adalah :

3,1809 lbr multipleks 15mm.....	@ Rp. 60.000,00	= Rp. 63.617,36
0,1157 m ³ kayu bekisting	@ Rp.1.700.000,00	= Rp. 65.562,68
1,6654 kg paku	@ Rp. 6.000,00	= Rp. 9.992,40
1,6654 ltr minyak pelumas.....	@ Rp. 12.500,00	= <u>Rp. 20.817,50</u>
Jumlah		= Rp.159.989,94
Upah borongan : 8,327 m ² x Rp. 9.250,00.....		= <u>Rp. 77.024,75</u>
Total (upah + bahan)		= Rp.237.014,69
Harga satuan pekerjaan bekisting		= Rp.237.014,69

Catatan : - kayu bekisting menggunakan kayu kruing dengan asumsi bahwa bekisting dapat digunakan sebanyak 3 kali dan terdapat kenaikan biaya 10% pada tiap lantainya untuk perbaikan bekisting.

Untuk perhitungan volume bekisting kolom tipe yang lain dari lantai 1 sampai dengan lantai atap, dapat dilihat pada lampiran 6 perhitungan volume beton dan volume bekisting kolom.

4. Scaffolding / Perancah

Kebutuhan scaffolding tiap 1 m³ beton :

6 support.....	@ Rp. 9.500,00	= Rp. 57.000,00
6 U-head.....	@ Rp. 3.000,00	= Rp. 12.000,00
6 jack base.....	@ Rp. 3.000,00	= <u>Rp. 12.000,00</u>
	Jumlah	= Rp. 81.000,00
Upah pasang + bongkar : 8,327 m ² x Rp. 2.500,00.....		= <u>Rp. 20.817,50</u>
	Jumlah	= Rp. 101.817,50

Harga satuan pekerjaan kolom lantai 1 tipe KLI (40/65) :

- Biaya cor		= Rp. 314.000,00
- Biaya penulangan.....		= Rp.1.828.208,00
- Biaya bekisting.....		= Rp. 237.014,69
- Scaffolding/perancah.....		= <u>Rp. 101.817,50</u>
	Jumlah	= Rp.2.481.040,19

Tabel 5.9 Harga Satuan Pekerjaan Kolom Lantai 1 Tipe KL1

Uraian	Vol.	Sat	Harga Satuan (Rp)	Analisis Harga Bahan (Rp)	Analisis Harga Upah (Rp)	Total Harga Analisis (Rp)
BAHAN						
Paku	1,67	kg	6.000,00	9.992,40		
Besi ulir	435,64	kg	3.350,00	1.459.394,00		
Besi polos	69,38	kg	3.000,00	208.140,00		
Multipleks 15mm(33,333%)	3,18	lbr	60.000,00	63.617,36		
Beton ready mix	1,00	m ³	274.000,00	274.000,00		
Kayu bekisting (33,333%)	0,12	m ³	1.700.000,00	65.562,68		
Bendirat	9,18	kg	6.500,00	59.670,00		
Minyak bekisting	1,67	ltr	12.500,00	20.817,50		2.161.193,94
UPAH BORONGAN						
Cor ready mix	1,00	m ³	40.000,00		40.000,00	
Buat + stel besi	505,02	kg	200,00		101.004,00	
Bekisting	8,33	m ²	9.250,00		77.024,75	
Pas+bongkar scaff.	8,33	m ²	2.500,00		20.817,50	
Scaffolding	6,00	set	13.500,00		81.000,00	319.846,25
					Jumlah	2.481.040,19
					Dibulatkan	2.481.040,00

Kolom lantai 1 tipe KL1 mempunyai volume beton 11,23 m³, maka :

Harga pekerjaan kolom lantai 1 tipe KL1 = 11,23 m³ x Rp. 2.481.040,19

= Rp. 27.862.081,33

Pada lampiran 6 diberikan juga harga satuan pekerjaan tiap tipe kolom dan harga tiap pekerjaan tipe kolom yang lainnya, dari lantai 1 sampai dengan atap.

5.2.7 Pekerjaan Beton Balok Lantai

Balok Lantai 2 Tipe G1 (65/90)

Balok tipe G1 (balok induk) yaitu balok T

Jumlah tipe balok G1 = 4 buah

Luasan 1 : lebar = 0,65 m ; tinggi = 0,50 m ; tinggi pelat lantai = 0,12 m

Tinggi bersih luasan 1 = tinggi balok – tinggi pelat

$$= 0,50 - 0,12 = 0,38 \text{ m}$$

Luasan 2 : lebar 0,45 m ; tinggi = 0,40 m

Panjang balok (as ke as) = 10,80 m

Panjang bersih = panjang balok – kolom

$$= 10,80 - 0,75 = 10,05 \text{ m}$$

Volume beton satu buah balok G1 = ((0,65 x 0,38) + (0,45 x 0,40)) x 10,05

$$= 4,29 \text{ m}^3$$

Volume beton total tipe G1 = 4,29 x 4 = 17,17 m³

1. Beton

- Biaya 1 m³ beton $f_c' 25 \text{ Mpa}$:

1 m³ beton ready mix $f_c' 25 \text{ Mpa}$ = Rp. 274.000,00

1 m³ sewa pompa..... = Rp. 8.000,00

Upah cor..... = Rp. 9.250,00

Jumlah..... = Rp. 291.250,00

Harga satuan pekerjaan pencoran beton = Rp. 291.250,00

Untuk perhitungan volume beton balok lantai dari lantai 2 sampai dengan atap tipe yang lain, dapat dilihat pada lampiran 7 perhitungan volume bekisting dan volume beton balok lantai.

2. Besi beton

Perhitungan kebutuhan besi :

* Tulangan sengkang / begel

- Tulangan sengkang / begel 1 : $\varnothing 6$ - 250.

Panjang satu buah tulangan sengkang :

Keliling balok – selimut kolom + 2 kait

$$= ((0,65 + 0,50) \times 2) - (0,05 \times 4) + (2 \times 10 \times 0,006) = 2,22 \text{ m}$$

Jumlah tulangan sengkang : (panjang besi / jarak antar sengkang) + 1 buah

$$= (10,05 / 0,25) + 1 = 41 \text{ buah}$$

Berat besi sengkang : jumlah sengkang x panjang 1 buah sengkang x berat (kg/m)

$$= 41 \times 2,22 \times 0,22 = 20,12 \text{ kg}$$

- Tulangan sengkang / begel 2 : $2\varnothing 10$ - 100.

Panjang satu buah tulangan sengkang :

Keliling balok – selimut kolom + 2 kait

$$= (2 \times (0,45 + 0,90) \times 2) - (0,05 \times 4) + (2 \times 10 \times 0,010) = 5,40 \text{ m}$$

Jumlah tulangan sengkang : (panjang besi / jarak antar sengkang) + 1 buah

$$= (3,60 / 0,10) + 1 = 37 \text{ buah}$$

Berat besi sengkang : jumlah sengkang x panjang 1 buah sengkang x berat (kg/m)

$$= 37 \times 5,40 \times 0,62 = 123,88 \text{ kg}$$

- Tulangan sengkang / begel 2 : $\varnothing 10$ - 150.

Panjang satu buah tulangan sengkang :

Keliling balok – selimut kolom + 2 kait

$$= ((0,45 + 0,90) \times 2) - (0,05 \times 4) + (2 \times 10 \times 0,010) = 2,70 \text{ m}$$

Jumlah tulangan sengkang : (panjang besi / jarak antar sengkang) + 1 buah

$$= (6,45 / 0,15) + 1 = 44 \text{ buah}$$

Berat besi sengkang : jumlah sengkang x panjang 1 buah sengkang x berat (kg/m)

$$= 44 \times 2,70 \times 0,62 = 73,66 \text{ kg}$$

- Berat total besi sengkang = $20,12 + 123,88 + 73,66 = 217,66 \text{ kg}$

* Tulangan Tumpuan

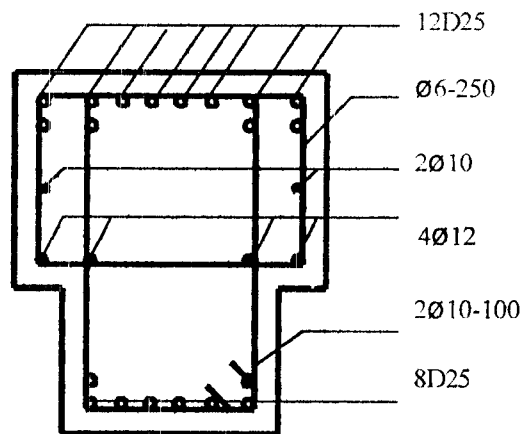

- Kebutuhan besi tulangan tumpuan atas 12D25 untuk satu balok :

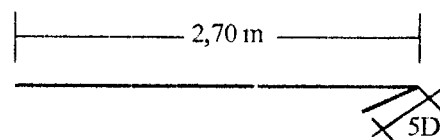

(panjang tulangan + kait) x jumlah tulangan tumpuan

$$= (2,70 + (5 \times 0,025)) \times 6 = 16,95 \text{ m}$$

Berat tulangan tumpuan atas = $16,95 \text{ m} \times 3,85 \text{ kg/m} = 65,26 \text{ kg}$

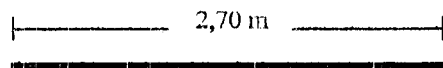

panjang tulangan x jumlah tulangan tumpuan = $2,70 \times 6 = 16,20 \text{ m}$

Berat tulangan tumpuan = $16,20 \text{ m} \times 3,85 \text{ kg/m} = 62,37 \text{ kg}$

- Kebutuhan besi tulangan tumpuan bawah 8D25 untuk satu balok :

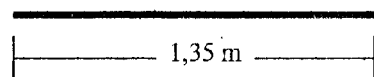

panjang tulangan x jumlah tulangan tumpuan = $1,35 \times 8 = 10,80 \text{ m}$

Berat tulangan tumpuan = $10,80 \text{ m} \times 3,85 \text{ kg/m} = 41,58 \text{ kg}$

* Tulangan Tumpuan

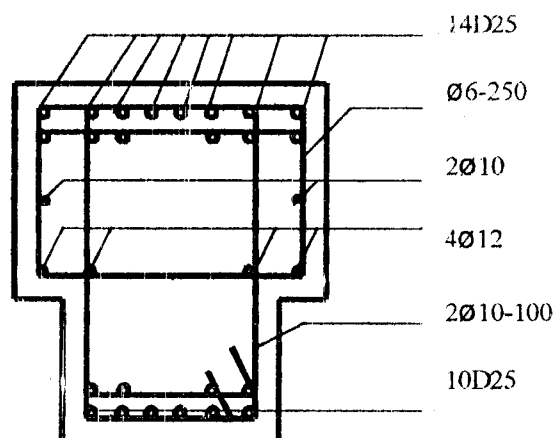

- Kebutuhan besi tulangan tumpuan atas 14D25 untuk satu balok :

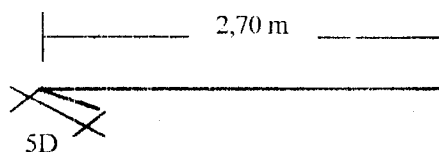

(panjang tulangan + kait) x jumlah tulangan tumpuan

$$= (2,70 + (5 \times 0,025)) \times 8 = 22,60 \text{ m}$$

$$\text{Berat tulangan tumpuan} = 22,60 \text{ m} \times 3,85 \text{ kg/m} = 87,01 \text{ kg}$$

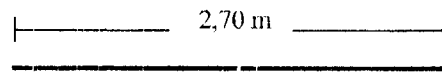

$$\text{panjang tulangan} \times \text{jumlah tulangan tumpuan} = 2,70 \times 6 = 16,20 \text{ m}$$

$$\text{Berat tulangan tumpuan} = 16,20 \text{ m} \times 3,85 \text{ kg/m} = 62,37 \text{ kg}$$

- Kebutuhan besi tulangan tumpuan bawah 10D25 untuk satu balok :

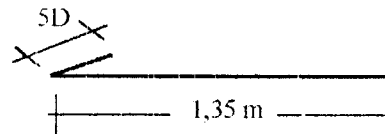

(panjang tulangan + kait) x jumlah tulangan tumpuan

$$= ((1,35 + (5 \times 0,025)) \times 2 = 2,95 \text{ m}$$

$$\text{Berat tulangan tumpuan} = 2,95 \text{ m} \times 3,85 \text{ kg/m} = 11,36 \text{ kg}$$

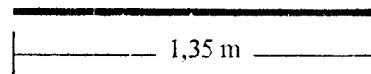

$$\text{panjang tulangan} \times \text{jumlah tulangan tumpuan} = 1,35 \times 8 = 10,80 \text{ kg}$$

$$\text{Berat tulangan tumpuan} = 10,80 \text{ m} \times 3,85 \text{ kg/m} = 41,58 \text{ kg}$$

• Berat total tulangan tumpuan = berat tulangan tumpuan atas + berat tulangan

tumpuan bawah

$$= 65,26 + 62,37 + 41,58 + 87,01 + 62,37 +$$

$$11,36 + 41,58$$

$$= 371,53 \text{ kg}$$

* Tulangan Lapangan

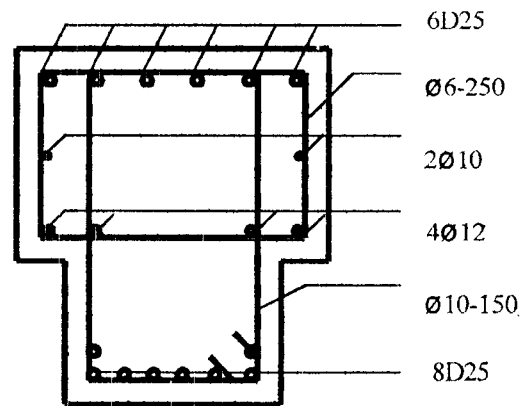

- Kebutuhan besi tulangan lapangan atas 6D25 untuk satu balok :

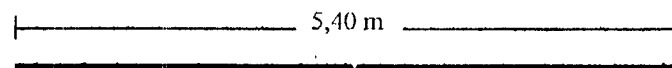

panjang tulangan x jumlah tulangan lapangan = $5,40 \times 6 = 32,40$ m

Berat tulangan lapangan = $32,40 \text{ m} \times 3,85 \text{ kg/m} = 124,74$ kg

- Kebutuhan besi tulangan lapangan bawah 8D25 untuk satu balok :

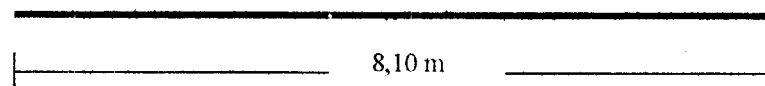

panjang tulangan x jumlah tulangan lapangan = $8,10 \times 8 = 64,80$ m

Berat tulangan lapangan = $64,80 \text{ m} \times 3,85 \text{ kg/m} = 249,48$ kg

- Berat total tulangan lapangan = berat tulangan lapangan atas + berat tulangan lapangan bawah

$$= 124,74 + 249,48$$

$$= 374,22 \text{ kg}$$

* Tulangan susut

- Tulangan susut 2P10

Kebutuhan besi tulangan susut :

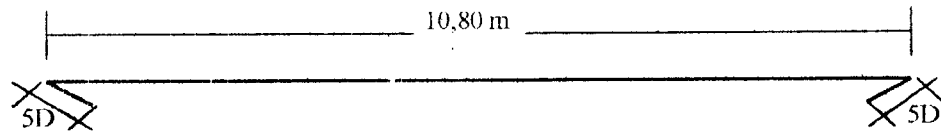

(panjang balok + 2 kait) x jumlah tulangan susut :

$$= ((10,8 + (2 \times 5 \times 0,010)) \times 2 = 21,80 \text{ m}$$

$$\text{Berat tulangan susut} = 21,80 \text{ m} \times 0,62 \text{ kg/m} = 13,52 \text{ kg}$$

- Tulangan susut 4P12

Kebutuhan besi tulangan susut :

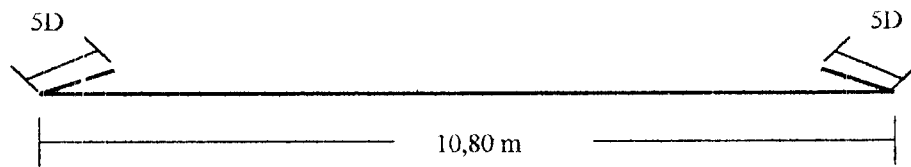

(panjang balok + 2 kait) x jumlah tulangan susut :

$$= ((10,8 + (2 \times 5 \times 0,012)) \times 4 = 43,68 \text{ m}$$

$$\text{Berat tulangan susut} = 43,68 \text{ m} \times 0,89 \text{ kg/m} = 38,88 \text{ kg}$$

- Berat total tulangan susut = $13,52 + 38,88 = 52,40 \text{ kg}$
- Berat total besi tulangan polos = berat tulangan begel + berat tulangan susut
 $= 217,66 + 52,40 = 270,06 \text{ kg}$
- Berat total besi tulangan ulir = berat tulangan tumpuan + berat tulangan lapangan
 $= 371,53 + 374,22 = 745,75 \text{ kg}$

$$\begin{aligned} \text{Volume beton satu buah balok G1} &= ((0,65 \times 0,38) + (0,45 \times 0,40)) \times 10,05 \\ &= 4,29 \text{ m}^3 \end{aligned}$$

Jadi dalam 1 m³ beton kebutuhan besi tulangan polos =

$$(1 / 4,29) \times 270,06 = 62,951 \text{ kg}$$

- Biaya penulangan untuk 1 kg besi polos :

1,1000 kg besi polos	@ Rp. 3.000,00	= Rp. 3.300,00
0,0200 kg kawat beton	@ Rp. 6.500,00	= <u>Rp. 130,00</u>
Jumlah		= Rp. 3.430,00
Upah borongan		= <u>Rp. 215,00</u>
Jumlah (upah + bahan)		= Rp. 3.645,00

Tiap 1 m³ beton perlu besi tulangan polos 62,951 kg, jadi :

$$62,951 \text{ kg} \times \text{Rp. } 3.645,00 = \text{Rp. } 230.809,39$$

Jadi dalam 1 m³ beton kebutuhan besi tulangan ulir =

$$(1 / 4,29) \times 745,75 = 173,833 \text{ kg}$$

- Biaya penulangan untuk 1 kg besi ulir :

1,1000 kg besi ulir	@ Rp. 3.350,00	= Rp. 3.685,00
0,0200 kg kawat beton	@ Rp. 6.500,00	= <u>Rp. 130,00</u>
Jumlah		= Rp. 3.815,00
Upah borongan		= <u>Rp. 215,00</u>
Jumlah (upah + bahan)		= Rp. 4.030,00

Tiap 1 m³ beton perlu besi tulangan ulir 173,833 kg, jadi :

$$173,833 \text{ kg} \times \text{Rp. } 4.030,00 = \text{Rp. } 707.924,76$$

Untuk perhitungan kebutuhan besi tulangan balok lantai tipe yang lain, dapat dilihat pada lampiran 7 perhitungan kebutuhan besi tulangan pokok balok lantai, perhitungan kebutuhan besi tulangan begel balok lantai, dan untuk rekap kebutuhan besi tulangan berdasarkan jenis besi yaitu untuk tulangan pokok balok lantai menggunakan besi ulir (D25), rekapitulasi kebutuhan besi tulangan ulir balok lantai, dan untuk rekap kebutuhan besi tulangan berdasarkan jenis besi yaitu untuk tulangan susut dan begel menggunakan besi polos (P10, P12 dan P6), rekapitulasi kebutuhan besi tulangan polos balok lantai.

$$\begin{aligned}
 \text{- Harga satuan pekerjaan penulangan} &= \text{harga penulangan besi polos} + \text{harga} \\
 &\quad \text{penulangan besi ulir} \\
 &= \text{Rp. 230.809,39} + \text{Rp. 707.924,76} \\
 &= \text{Rp. 938.734,15}
 \end{aligned}$$

3. Bekisting

Kebutuhan bekisting untuk satu balok :

$$= ((2 \times 0,38) + (2 \times 0,10) + (0,45 + (2 \times 0,4))) \times 10,05 = 22,21 \text{ m}^2$$

$$\text{Volume beton balok G1} = ((0,65 \times 0,38) + (0,45 \times 0,40)) \times 10,05 = 4,29 \text{ m}^3$$

$$\text{Jadi dalam } 1 \text{ m}^3 \text{ beton} = (1 / 4,29) \times 22,21 \text{ m}^2 = 5,18 \text{ m}^2$$

- Biaya 1 m² bekisting :

0,3820 lbr multipleks 15mm.....	@ Rp. 60.000,00	= Rp. 22.920,00
0,0139 m ³ kayu bekisting	@ Rp.1.700.000,00	= Rp. 23.630,00
0,2000 kg paku	@ Rp. 6.000,00	= Rp. 1.200,00
0,2000 ltr minyak bekisting	@ Rp. 12.500,00	= <u>Rp. 2.500,00</u>
Jumlah		= Rp. 50.250,00

Berdasarkan hitungan diatas, biaya bekisting untuk 1 m³ beton adalah :

1,9788 lbr multiplex 15mm.....	@ Rp. 60.000,00	= Rp. 39.575,60
0,0720 m ³ kayu bekisting	@ Rp.1.700.000,00	= Rp. 40.799,59
1,0360 kg paku	@ Rp. 6.000,00	= Rp. 6.216,00
1,0360 ltr minyak bekisting.....	@ Rp. 12.500,00	= <u>Rp. 12.950,00</u>
Jumlah		= Rp. 99.541,19
Upah borongan : 5,18 m ² x Rp. 10.850,00		= <u>Rp. 56.203,00</u>
Total (upah + bahan)		= Rp.155.744,19
Harga satuan pekerjaan bekisting		= Rp.155.744,19

Catatan : - kayu bekisting menggunakan kayu kruing dengan asumsi bahwa bekisting dapat digunakan sebanyak 3 kali dan terdapat kenaikan biaya 10% pada tiap lantainya untuk perbaikan bekisting.

Untuk perhitungan volume bekisting balok lantai dari lantai 2 sampai dengan atap tipe yang lain, dapat dilihat pada lampiran 7 perhitungan volume bekisting dan volume beton balok lantai.

4. Scaffolding / Perancah

Untuk kebutuhan scaffolding ukuran yang digunakan yaitu main frame dengan lebar 1,20 m dan tinggi 1,50 m. Untuk cross brace digunakan ukuran 1,80 m. Tinggi elevasi lantai 2 adalah 4,58 m, tinggi balok 0,90 m. Tinggi kebutuhan scaffolding = $4,58 - 0,90 = 3,68$ m.

Kebutuhan scaffolding untuk tiap balok tipe G1 :

12 main frame.....	@ Rp. 3.000,00	= Rp. 36.000,00
20 cross brace	@ Rp. 4.500,00	= Rp. 90.000,00
12 joint pin	@ Rp. 3.000,00	= Rp. 36.000,00
12 U-head.....	@ Rp. 3.000,00	= Rp. 36.000,00
12 jack base	@ Rp. 3.000,00	= <u>Rp. 36.000,00</u>
	Jumlah	= Rp. 234.000,00
Upah pasang + bongkar : $22,21 \text{ m}^2 \times \text{Rp. } 2.500,00$		= <u>Rp. 55.525,00</u>
	Jumlah	= Rp. 289.525,00

Harga satuan pekerjaan balok lantai 2 tipe G1 (65/90) :

- Biaya cor	= Rp. 291.250,00
- Biaya penulangan.....	= Rp. 938.734,16
- Biaya bekisting.....	= <u>Rp. 155.744,19</u>
	Jumlah = Rp. 1.385.728,35

Tabel 5.10 Harga Satuan Pekerjaan Balok Lantai 2 Tipe G1

Uraian	Vol.	Sat	Harga Satuan (Rp)	Analisis Harga Bhn (Rp)	Analisis Harga Upah (Rp)	Total Harga Analisis (Rp)
BAHAN						
Paku	1,04	kg	6.000,00	6.216,00		
Besi ulir	192,20	kg	3.350,00	643.883,40		
Besi polos	69,25	kg	3.000,00	207.738,00		
Multipleks 15mm (33,333%)	1,98	lbr	60.000,00	39.575,60		
Beton ready mix	1,00	m ³	274.000,00	274.000,00		
Kayu bekisting (33,333%)	0,07	m ³	1.700.000,00	40.799,59		
Bendrat	4,75	kg	6.500,00	30.901,00		
Minyak bekisting	1,04	ltr	12.500,00	12.950,00		1.256.063,60
UPAH BORONGAN						
Cor ready mix	1,00	m ³	9.250,00		9.250,00	
Buat + stel besi	261,45	kg	215,00		56.211,75	
Bekisting	5,18	m ²	10.850,00		56.203,00	
Pompa	1,00	m ³	8.000,00		8.000,00	129.664,75
					Jumlah	1.385.728,35
					Dibulatkan	1.385.728,00

Satu buah balok lantai 2 tipe G1 mempunyai volume beton 4,29 m³, maka :

Harga pekerjaan satu buah balok lantai 2 tipe G1 :

= (volume x harga satuan pekerjaan) + sewa scaffolding

= (4,29 m³ x Rp. 1.385.728,35) + Rp. 289.525,00

= Rp. 6.324.299,62

- Jumlah balok lantai 2 tipe G1 = 4 buah

Harga pekerjaan balok lantai 2 tipe G1 = 4 x Rp. 6.324.299,62

= Rp. 25.297.198,48

Pada lampiran 7 diberikan juga harga satuan pekerjaan tiap tipe balok dan harga tiap pekerjaan balok tipe yang lainnya, dari lantai 2 sampai dengan atap.

5.2.8 Pekerjaan Beton Pelat Lantai

Pelat Lantai 2 Tipe P1

Ukuran pelat (3,60 x 3,60) m²

Tebal pelat = 0,12 m

Jumlah tipe P1 = 52 buah

Lebar pelat aktual = 3,075 m ; panjang pelat aktual = 3,075 m

Volume beton satu buah = 3,60 x 3,60 x 0,12 = 1,56 m³

Volume beton total = 1,56 x 52 = 80,87 m³

Untuk perhitungan volume beton pelat lantai tipe yang lain, dapat dilihat pada lampiran 8 perhitungan volume bekisting dan volume beton pelat lantai.

1. Beton

- Biaya 1 m³ beton *fc'* 25 Mpa :

1 m ³ beton ready mix <i>fc'</i> 25Mpa	= Rp. 274.000,00
1 m ³ sewa pompa.....	= Rp. 8.000,00
Upah cor.....	= <u>Rp. 9.250,00</u>
Jumlah.....	= Rp. 291.250,00
Harga satuan pekerjaan pencoran beton	= Rp. 291.250,00

2. Besi Beton

Tipe 1

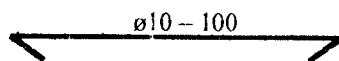

$$L = (5d + 0,5 Lx + 5d) \times 4 = (50 + 1800 + 50) \times 4 = 7600 \text{ mm}$$

$$\text{Jumlah tulangan (n)} = \frac{(3600 - 400)}{100} + 1 = 33 \text{ buah}$$

$$\text{Berat tulangan} = 33 \times 7,60 \times 0,62 \text{ kg/m} = 155,50 \text{ kg}$$

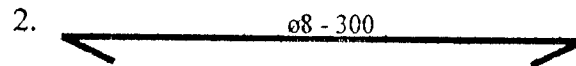

$$L = (5d + 0,75 L_x + 5d) = (40 + 2700 + 40) \times 2 = 5560 \text{ mm}$$

$$\text{Jumlah tulangan (n)} = \frac{(3600 - 400)}{300} + 1 = 12 \text{ buah}$$

$$\text{Berat tulangan} = 12 \times 5,56 \times 0,37 \text{ kg/m} = 24,69 \text{ kg}$$

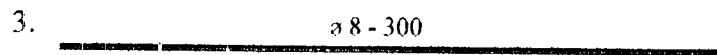

$$L = 2 \times L_x = 2 \times 3600 = 7200 \text{ mm}$$

$$\text{Jumlah tulangan (n)} = \frac{(3600 - 400)}{300} + 1 = 12 \text{ buah}$$

$$\text{Berat tulangan} = 12 \times 7,20 \times 0,37 \text{ kg/m} = 31,97 \text{ kg}$$



$$L = (5d + 50 + 1,25 L_x + 5d) \times 2 = (50 + 50 + 4500 + 50) \times 2 = 9300 \text{ mm}$$

$$\text{Jumlah tulangan (n)} = \frac{(3600 - 400)}{200} + 1 = 17 \text{ buah}$$

$$\text{Berat tulangan} = 17 \times 9,30 \times 0,62 \text{ kg/m} = 98,02 \text{ kg}$$

5. 

$$L = (5d + 50 + 1,25 Lx + 5d) \times 2 = (50 + 50 + 4500 + 50) \times 2 = 9300 \text{ mm}$$

$$\text{Jumlah tulangan (n)} = \frac{(3600 - 400)}{200} + 1 = 17 \text{ buah}$$

$$\text{Berat tulangan} = 17 \times 9,30 \times 0,62 \text{ kg/m} = 98,02 \text{ kg}$$

- Berat total tulangan = 155,50 + 24,69 + 31,97 + 98,02 + 98,02
= 408,20 kg

$$\text{Volume beton} = 0,36 \times 0,36 \times 0,12 = 1,56 \text{ m}^3$$

$$\text{Jadi dalam } 1 \text{ m}^3 \text{ beton} = (1 / 1,56) \times 408,20 \text{ kg} = 261,67 \text{ kg}$$

- Biaya penulangan untuk 1 kg besi polos :

$$1,1000 \text{ kg besi polos} \dots\dots\dots @ \text{ Rp. } 3.000,00 = \text{Rp. } 3.300,00$$

$$0,0200 \text{ kg kawat beton} \dots\dots\dots @ \text{ Rp. } 6.500,00 = \text{Rp. } 130,00$$

$$\text{Jumlah} \dots\dots\dots = \text{Rp. } 3.430,00$$

$$\text{Upah borongan} \dots\dots\dots = \text{Rp. } 245,00$$

$$\text{Jumlah (upah + bahan)} \dots\dots\dots = \text{Rp. } 3.675,00$$

Tiap 1 m³ beton perlu tulangan 261,67 kg besi maka :

$$261,67 \text{ kg} \times \text{Rp. } 3.675,00 = \text{Rp. } 968.057,90$$

$$\text{Harga satuan pekerjaan penulangan} \dots\dots\dots = \text{Rp. } 968.057,90$$

Untuk perhitungan kebutuhan besi tulangan pelat lantai tipe yang lain, dapat dilihat pada lampiran 8 perhitungan kebutuhan besi tulangan pelat lantai.

3. Bekisting

Ukuran pelat aktual (3,075 x 3,075) m²

Kebutuhan bekisting untuk satu pelat :

$$= 3,075 \times 3,075 = 9,46 \text{ m}^2$$

$$\text{Volume beton} = 3,6 \times 3,6 \times 0,12 = 1,56 \text{ m}^3$$

$$\text{Jadi dalam 1 m}^3 \text{ beton} = (1 / 1,56) \times 9,46 \text{ m}^2 = 6,06 \text{ m}^2$$

- Biaya 1 m² bekisting :

0,3820 lbr multipleks 15mm.....	@ Rp. 60.000,00	= Rp. 46.297,54
0,0139 m ³ kayu bekisting	@ Rp. 1.700.000,00	= Rp. 47.712,86
0,2000 kg paku	@ Rp. 6.000,00	= Rp. 1.200,00
0,2000 ltr minyak bekisting	@ Rp. 12.500,00	= <u>Rp. 2.500,00</u>
Jumlah		= Rp. 52.250,00

Berdasarkan hitungan diatas, biaya bekisting untuk 1 m³ beton adalah :

2,3149 lbr multipleks 15mm.....	@ Rp. 60.000,00	= Rp. 46.297,54
0,0842 m ³ kayu bekisting	@ Rp. 1.700.000,00	= Rp. 47.712,86
1,2120 kg paku	@ Rp. 6.000,00	= Rp. 7.272,00
1,2120 ltr minyak bekisting.....	@ Rp. 12.500,00	= <u>Rp. 15.150,00</u>
Jumlah		= Rp. 116.432,40
Upah borongan : 6,06 m ² x Rp. 10.850,00		= <u>Rp. 65.751,00</u>
Total (upah + bahan)		= Rp. 182.183,40
Harga satuan pekerjaan bekisting		= Rp. 182.183,40

Catatan : - kayu bekisting menggunakan kayu kruing dengan asumsi bahwa bekisting dapat digunakan sebanyak 3 kali dan terdapat kenaikan biaya 10% pada tiap lantainya untuk perbaikan bekisting.

Untuk perhitungan volume bekisting pelat lantai tipe yang lain, dapat dilihat pada lampiran 8 perhitungan volume beton dan volume bekisting pelat lantai.

4. Scaffolding / Perancah

Untuk kebutuhan scaffolding luasan pelat 3,60 m x 3,60 m, ukuran scaffolding yang digunakan yaitu main frame dengan lebar 1,20 m dan tinggi 1,90 m. Untuk cross brace digunakan ukuran 1,80 m. Tinggi elevasi lantai 2 adalah 4,58 m, tinggi pelat 0,12 m. Tinggi kebutuhan scaffolding = 4,58 – 0,12 = 4,46 m.

Kebutuhan scaffolding untuk tiap pelat tipe P1 :

4 main frame.....	@ Rp. 3.000,00	= Rp. 12.000,00
4 cross brace	@ Rp. 4.500,00	= Rp. 18.000,00
4 joint pin	@ Rp. 3.000,00	= Rp. 12.000,00
4 U-head.....	@ Rp. 3.000,00	= Rp. 12.000,00
4 jack base	@ Rp. 3.000,00	= <u>Rp. 12.000,00</u>
	Jumlah	= Rp. 66.000,00
Upah pasang + bongkar : 9,46 m ² x Rp. 2.500,00.....		= <u>Rp. 23.650,00</u>
	Jumlah	= Rp. 89.650,00

Harga satuan pekerjaan pelat lantai 2 tipe P1 :

- Biaya cor	= Rp. 291.250,00
- Biaya penulangan.....	= Rp. 968.057,90
- Biaya bekisting.....	= <u>Rp. 182.183,40</u>
Jumlah = Rp. 1.441.491,30	

Tabel 5.11 Harga Satuan Pekerjaan Pelat Lantai 2 Tipe P1

Uraian	Vol.	Sat	Harga Satuan (Rp)	Analisis Harga Bhn (Rp)	Analisis Harga Upah (Rp)	Total Harga Analisis (Rp)
BAHAN						
Paku	1,21	kg	6.000,00	7.272,00		
Besi polos	287,84	kg	3.000,00	863.520,00		
Multipleks 15mm (33,333%)	2,31	lbr	60.000,00	46.297,54		
Beton ready mix	1,00	m ³	274.000,00	274.000,00		
Kayu bekisting (33,333%)	0,08	m ³	1.700.000,00	47.712,86		
Bendrat	5,23	kg	6.500,00	34.017,10		
Minyak bekisting	1,21	ltr	12.500,00	15.150,00		1.287.969,30
UPAH BORONGAN						
Cor ready mix	1,00	m ³	9.250,00		9.250,00	
Buat + stel besi	287,84	kg	245,00		70.520,00	
Bekisting	6,06	m ²	10.850,00		65.751,00	
Pompa	1,00	m ³	8.000,00		8.000,00	153.522,00
					Jumlah	1.441.491,30
					Dibulatkan	1.441.491,00

Satu buah pelat lantai 2 tipe P1 mempunyai volume beton $1,56 \text{ m}^3$, maka :

Harga pekerjaan satu buah pelat lantai 2 tipe P1 :

= (volume x harga satuan pekerjaan) + sewa scaffolding

= ($1,56 \text{ m}^3$ x Rp. 1.441.491,30) + Rp. 89.650,00

= Rp. 2.338.376,43

- Jumlah pelat lantai 2 tipe G1 = 52 buah

Harga pekerjaan pelat lantai 2 tipe P1 = 52 x Rp. 2.338.376,43

= Rp. 121.595.574,40

Pada lampiran 8 diberikan juga harga satuan pekerjaan tiap tipe pelat dan harga tiap pekerjaan pelat tipe yang lainnya, dari lantai 2 sampai dengan atap.

5.2.9 Pekerjaan Beton Ring Balk

Panjang ring balk (as ke as) = 10,80 m

Panjang bersih = 10,40 m

Lebar ring balk = 0,40 m

Tinggi ring balk = 0,80 m

Jumlah ring balk = 2 buah

Volume beton ring balk = $0,40 \times 0,80 \times 10,40 = 3,33 \text{ m}^3$

Volume beton total = $2 \times 3,33 = 6,66 \text{ m}^3$

Untuk perhitungan volume beton ring balk tipe yang lain, dapat dilihat pada lampiran 9 perhitungan volume beton dan bekisting ring balk.

1. Beton

- Biaya 1 m^3 beton $f_c' 25 \text{ Mpa}$:

1 m^3 beton ready mix $f_c' 25 \text{ Mpa}$ = Rp. 274.000,00

1 m^3 sewa pompa..... = Rp. 8.000,00

Upah cor..... = Rp. 9.250,00

Jumlah = Rp. 291.250,00

Harga satuan pekerjaan pencoran beton = Rp. 291.250,00

2. Besi beton

Perhitungan kebutuhan besi :

- Tulangan sengkang / begel \varnothing 10-150.

Panjang satu buah tulangan sengkang :

Keliling ring balk – selimut kolom + 2 kait

$$= ((0,4 + 0,8) \times 2) - (0,05 \times 4) + (2 \times 10 \times 0,01) = 2,40 \text{ m}$$

Jumlah tulangan sengkang : (panjang besi / jarak antar sengkang) + 1 buah

$$= (8,10 / 0,15) + 1 = 55 \text{ buah}$$

Berat besi sengkang : jumlah sengkang x panjang 1 buah sengkang x berat (kg/m)

$$= 55 \times 2,40 \times 0,62 = 81,84 \text{ kg}$$

- Tulangan sengkang / begel \varnothing 10-100.

Panjang satu buah tulangan sengkang :

Keliling ring balk -- selimut kolom + 2 kait

$$= ((0,4 + 0,8) \times 2) - (0,05 \times 4) + (2 \times 10 \times 0,01) = 2,40 \text{ m}$$

Jumlah tulangan sengkang : (panjang besi / jarak antar sengkang) + 1 buah

$$= (2,00 / 0,10) + 1 = 21 \text{ buah}$$

Berat besi sengkang : jumlah sengkang x panjang 1 buah sengkang x berat (kg/m)

$$= 21 \times 2,40 \times 0,62 = 31,25 \text{ kg}$$

• Berat total tulangan sengkang = 81,84 + 31,25 = 113,09 kg.

* Tulangan Tumpuan

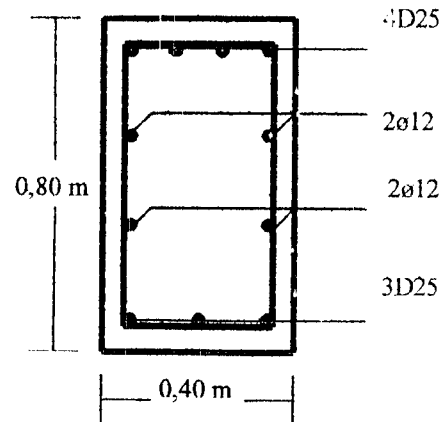

- Kebutuhan besi tulangan tumpuan atas 4D25 untuk satu ring balk :

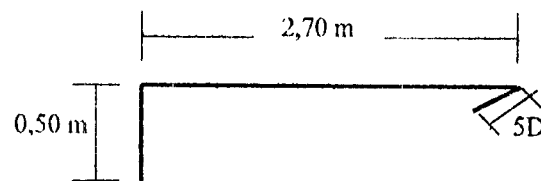

(panjang tulangan + kait) x jumlah tulangan tumpuan

$$= (3,20 + (5 \times 0,025)) \times 1 = 3,33 \text{ m}$$

$$\text{Berat tulangan tumpuan} = 3,33 \text{ m} \times 3,85 \text{ kg/m} = 12,80 \text{ kg}$$

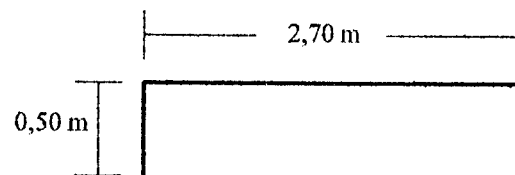

$$\text{panjang tulangan} \times \text{jumlah tulangan tumpuan} = 3,20 \times 3 = 9,60 \text{ m}$$

$$\text{Berat tulangan tumpuan} = 9,60 \text{ m} \times 3,85 \text{ kg/m} = 36,96 \text{ kg}$$

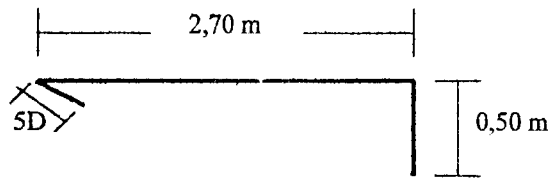

(panjang tulangan + kait) x jumlah tulangan tumpuan

$$= (3,20 + (5 \times 0,025)) \times 1 = 3,33 \text{ m}$$

$$\text{Berat tulangan tumpuan} = 3,33 \text{ m} \times 3,85 \text{ kg/m} = 12,80 \text{ kg}$$

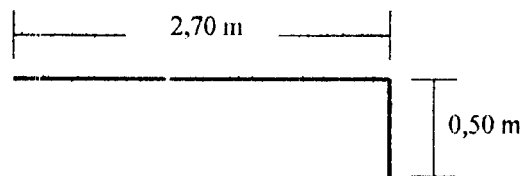

panjang tulangan x jumlah tulangan tumpuan = $3,20 \times 3 = 9,60 \text{ m}$

$$\text{Berat tulangan tumpuan} = 9,60 \text{ m} \times 3,85 \text{ kg/m} = 36,96 \text{ kg}$$

- Kebutuhan besi tulangan tumpuan bawah 3D25 untuk satu ring balk :

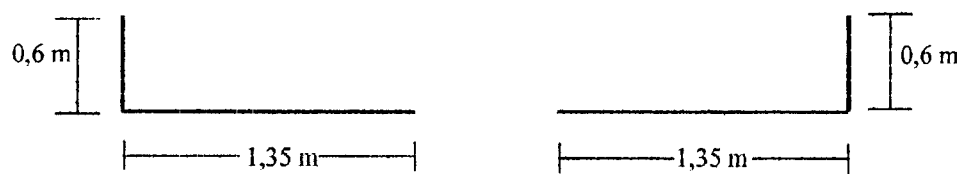

panjang tulangan x jumlah tulangan tumpuan = $3,90 \times 3 = 11,70 \text{ m}$

$$\text{Berat tulangan tumpuan} = 11,70 \text{ m} \times 3,85 \text{ kg/m} = 45,05 \text{ kg}$$

- Berat total tulangan tumpuan = $12,08 + 36,96 + 12,80 + 36,96 + 45,05$
 $= 144,57 \text{ kg}$

* Tulangan Lapangan

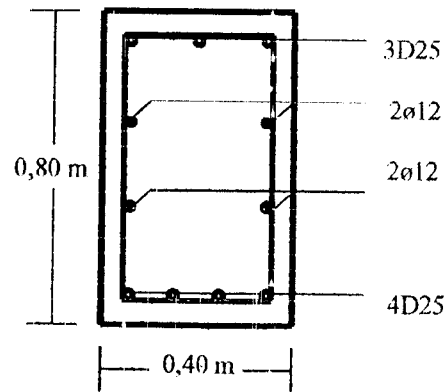

- Kebutuhan besi tulangan lapangan atas 3D25 untuk satu ring balk :

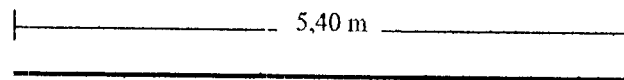

panjang tulangan x jumlah tulangan lapangan = $5,40 \times 3 = 16,20$ m

Berat tulangan lapangan = $16,20 \text{ m} \times 3,85 \text{ kg/m} = 62,37 \text{ kg}$

- Kebutuhan besi tulangan lapangan bawah 4D25 untuk satu ring balk :

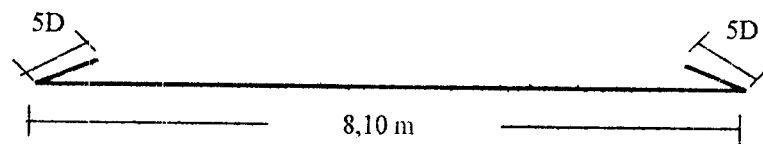

(panjang tulangan + kait) x jumlah tulangan lapangan

= $(8,10 + (2 \times 5 \times 0,025)) \times 1 = 8,35$ m

Berat tulangan lapangan = $8,35 \text{ m} \times 3,85 \text{ kg/m} = 32,15 \text{ kg}$

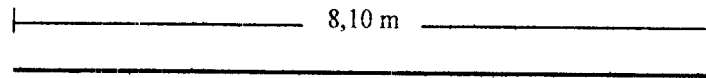

panjang tulangan x jumlah tulangan lapangan = $8,10 \times 3 = 24,30$ m

Berat tulangan lapangan = $24,30 \text{ m} \times 3,85 \text{ kg/m} = 93,56 \text{ kg}$

- Berat total tulangan lapangan = $62,37 + 32,15 + 93,56 = 188,08 \text{ kg}$

* Tulangan susut 4P12

Kebutuhan besi tulangan susut :

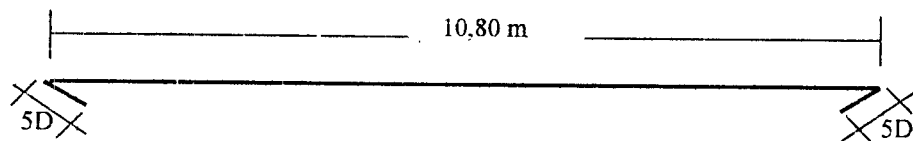

(panjang balok + 2 kait) x jumlah tulangan susut :

= $(10,80 + (2 \times 5 \times 0,012)) \times 4 = 43,68 \text{ m}$

Berat tulangan susut = $43,68 \text{ m} \times 0,89 \text{ kg/m} = 38,88 \text{ kg}$

- Berat tulangan ulir = berat tulangan tumpuan + berat tulangan lapangan
= $144,57 + 188,08 = 332,65 \text{ kg}$

- Berat tulangan polos = berat tulangan begel + berat tulangan susut
= $113,09 + 38,88 = 151,97 \text{ kg}$

Volume beton ring balk = $0,40 \times 0,80 \times 10,40 = 3,33 \text{ m}^3$

Jadi dalam 1 m^3 beton kebutuhan besi tulangan polos =

$(1 / 3,33) \times 151,97 = 45,637 \text{ kg}$

- Biaya penulangan untuk 1 kg besi polos :

1,1000 kg besi polos	@ Rp. 3.000,00	= Rp. 3.300,00
0,0200 kg kawat beton	@ Rp. 6.500,00	= Rp. <u>130,00</u>
Jumlah		= Rp. 3.430,00
Upah borongan		= Rp. <u>245,00</u>
Jumlah (upah + bahan)		= Rp. 3.675,00

Tiap 1 m³ beton perlu besi tulangan polos 45,637 kg, jadi :

$$45,637 \text{ kg} \times \text{Rp. } 3.675,00 = \text{Rp. } 168.833,50$$

Jadi dalam 1 m³ beton kebutuhan besi tulangan ulir =

$$(1 / 3,33) \times 332,65 = 99,895 \text{ kg}$$

- Biaya penulangan untuk 1 kg besi ulir :

1,1000 kg besi ulir	@ Rp. 3.350,00	= Rp. 3.685,00
0,0200 kg kawat beton	@ Rp. 6.500,00	= Rp. <u>130,00</u>
Jumlah		= Rp. 3.815,00
Upah borongan		= Rp. <u>245,00</u>
Jumlah (upah + bahan)		= Rp. 4.060,00

Tiap 1 m³ beton perlu besi tulangan ulir 99,895 kg, jadi :

$$99,895 \text{ kg} \times \text{Rp. } 4.060,00 = \text{Rp. } 408.019,98$$

Untuk perhitungan kebutuhan besi tulangan ring balk, dapat dilihat pada lampiran 9 perhitungan kebutuhan besi tulangan pokok dan begel ring balk dan disajikan juga untuk rekap kebutuhan besi tulangan berdasarkan jenis besi yaitu besi ulir dan polos.

- Harga satuan pekerjaan penulangan = harga penulangan besi polos + harga penulangan besi ulir
- $$= \text{Rp. } 168.833,50 + \text{Rp. } 408.019,98$$
- $$= \text{Rp. } 576.853,48$$

3. Bekisting

Kebutuhan bekisting untuk satu balok :

$$= ((0,80 \times 2) + (0,40 \times 1)) \times 10,40 = 20,80 \text{ m}^2$$

$$\text{Volume beton ring balk} = 0,40 \times 0,80 \times 10,40 = 3,33 \text{ m}^3$$

$$\text{Jadi dalam } 1 \text{ m}^3 \text{ beton} = (1 / 3,33) \times 20,80 \text{ m}^2 = 6,25 \text{ m}^2$$

Untuk perhitungan volume bekisting ring balk tipe yang lain, dapat dilihat pada lampiran 9 perhitungan volume beton dan bekisting ring balk.

- Biaya 1 m² bekisting :

0,3820 lbr multipleks 15mm.....	@ Rp. 60.000,00	= Rp. 22.920,00
0.01390 m ³ kayu bekisting	@ Rp. 1.700.000,00	= Rp. 23.630,00
0,2000 kg paku	@ Rp. 6.000,00	= Rp. 1.200,00
0,2000 ltr minyak bekisting	@ Rp. 12.500,00	= <u>Rp. 2.500,00</u>
Jumlah		= Rp. 50.250,00

Berdasarkan hitungan diatas. biaya bekisting untuk 1 m³ beton adalah :

2,3875 lbr multipleks 15mm.....	@ Rp. 60.000,00	= Rp. 71.625,00
0,0869 m ³ kayu bekisting	@ Rp.1.700.000,00	= Rp. 73.865,00
1,2500 kg paku	@ Rp. 6.000,00	= Rp. 7.500,00
1,2500 ltr minyak bekisting.....	@ Rp. 12.500,00	= <u>Rp. 15.625,00</u>
Jumlah		= Rp.168.615,00
Upah borongan : 6,25 m ² x Rp. 12.800,00		= <u>Rp. 80.000,00</u>
Total (upah + bahan)		= Rp.248.615,00
Harga satuan pekerjaan bekisting		= Rp.248.615,00

Catatan : - kayu bekisting menggunakan kayu kruing dengan asumsi bahwa bekisting dapat digunakan sebanyak 2 kali.

3. Scaffolding / Perancah

Untuk kebutuhan scaffolding ukuran yang digunakan yaitu main frame dengan lebar 1,20 m dan tinggi 1,50 m. Untuk cross brace digunakan ukuran 1,80 m. Tinggi kebutuhan scaffolding 3,20 m.

Kebutuhan scaffolding untuk tiap ring balk :

12 main frame	@ Rp. 3.000,00	= Rp. 36.000,00
20 cross brace	@ Rp. 4.500,00	= Rp. 90.000,00
12 joint pin	@ Rp. 3.000,00	= Rp. 36.000,00
12 U-head	@ Rp. 3.000,00	= Rp. 36.000,00
12 jack base	@ Rp. 3.000,00	= <u>Rp. 36.000,00</u>
Jumlah		= Rp. 234.000,00

Jumlah biaya sewa scaffolding	= Rp. 234.000,00
Upah pasang + bongkar : $20,80 \text{ m}^2 \times \text{Rp. } 2.500,00$	= <u>Rp. 52.000,00</u>
Jumlah	= Rp. 286.000,00

Harga satuan pekerjaan ring balk (40/80) :

- Biaya cor	= Rp. 291.250,00
- Biaya penulangan.....	= Rp. 576.853,48
- Biaya bekisting.....	= <u>Rp. 248.615,00</u>
Jumlah	= Rp.1.116.718,48

Tabel 5.12 Harga Satuan Pekerjaan Ring Balk

Uraian	Vol.	Sat	Harga Satuan (Rp)	Analisis Harga Bhn (Rp)	Analisis Harga Upah (Rp)	Total Harga Analisis (Rp)
BAHAN						
Paku	1,25	kg	6.000,00	7.500,00		
Besi ulir	109,88	kg	3.350,00	368.111,40		
Besi polos	50,20	kg	3.000,00	150.600,00		
Multiplex (50%)	2,39	lbr	60.000,00	71.625,00		
Beton ready mix	1,00	m ³	274.000,00	274.000,00		
Kayu bekisting (50%)	0,09	m ³	1.700.000,00	73.865,00		
Bendrat	2,91	kg	6.500,00	18.921,50		
Minyak bekisting	1,25	ltr	12.500,00	15.625,00		
UPAH BORONGAN						
Cor ready mix	1,00	m ³	9.250,00		9.250,00	
Buat + stel besi	160,08	kg	245,00		39.220,58	
Bekisting	6,25	m ²	12.800,00		80.000,00	
Pompa	1,00	m ³	8.000,00		8.000,00	
						980.247,90
					Jumlah	1.116.718,48
					Dibulatkan	1.116.718,00

Satu buah ring balk mempunyai volume beton $3,33 \text{ m}^3$, maka :

Harga pekerjaan satu buah ring balk :

= (volume x harga satuan pekerjaan) + sewa scaffolding

= ($3,33 \text{ m}^3$ x Rp. 1.116.718,48) + Rp. 286.000,00

= Rp. 4.004.672,54

- Jumlah ring balk = 2 buah

Harga pekerjaan ring balk = 2 x Rp. 4.004.672,54

= Rp. 8.009.345,08

Pada lampiran 9 diberikan juga harga satuan pekerjaan tiap tipe ring balk dan harga tiap pekerjaan ring balk tipe yang lainnya.

5.3. Rekap Anggaran Biaya

Rekap anggaran biaya di dapat dengan menjumlahkan harga dari tiap item pekerjaan. Dari hasil perhitungan harga tiap pekerjaan diatas dan dapat dilihat juga pada lampiran maka di dapat rekap anggaran biaya pada pekerjaan struktural “ Proyek Pembangunan Masjid Kampus UMY ” sebagai berikut :

I.	Pekerjaan urugan	: Rp.	224.781.250,00
II.	Pekerjaan tiang pancang	: Rp.	319.200.000,00
III.	Pekerjaan lantai kerja	: Rp.	11.161.698,49
IV.	Pekerjaan poer pile	: Rp.	85.470.755,59
V.	Pekerjaan balok sloof	: Rp.	94.976.480,89
VI.	Pekerjaan kolom	: Rp.	670.044.745,21
VII.	Pekerjaan balok	: Rp.	1.220.089.280,55
VIII.	Pekerjaan pelat	: Rp.	651.921.709,83
IX.	Pekerjaan ring balk	: Rp.	16.106.522,81
			<hr/>
	Total	: Rp.	3.293.752.443,37
	Dibulatkan	: Rp.	3.293.752.000,00

BAB VI

PEMBAHASAN

Menyusun rencana anggaran biaya proyek merupakan langkah awal dalam proses pembangunan suatu proyek, sehingga harus dilakukan dengan seteliti dan secermat mungkin agar diperoleh biaya bangunan yang efisien. Adapun pembahasan dari perhitungan anggaran biaya ini adalah :

1. Pada perhitungan Rencana Anggaran Biaya (RAB) dengan metoda Non BOW, analisis koefisien bahan di dapat berdasarkan gambar rencana, sedangkan harga upah yang diperhitungkan merupakan upah borongan. Upah borongan di dapat berdasarkan informasi dari bas borong tiap pekerjaan karena pekerjaan tersebut dikerjakan secara borongan. Apabila menggunakan upah borongan biasanya harga satuan upah pekerja menjadi relatif lebih murah dibandingkan dengan menggunakan harga upah yang dihitung harian. Upah borongan disini sudah termasuk dengan alat yang digunakan pada masing-masing pekerjaan. Harga upah mengalami kenaikan untuk tiap lantai karena semakin keatas, tingkat kesulitan dalam pengerjaan semakin besar dan membutuhkan waktu dalam pengangkutan material ke lokasi pekerjaan.

2. Pekerjaan urugan pada proyek ini mempunyai volume yang cukup besar karena letak lantai dasar (elevasi 0,00) berada 2 meter di atas permukaan tanah asli. Pada pekerjaan urugan ini mengambil sirtu dari sungai Krasak dan tanah dari Potorono, Bantul. Pada pekerjaan urugan ini, biaya yang dikeluarkan cukup besar karena volume urugan yang dibutuhkan cukup besar juga. Prosentase harga pekerjaan urugan terhadap total biaya pekerjaan struktural adalah :

$$\frac{224.781.250,00}{3.293.752.443,37} \times 100 \% = 6,8245 \%$$

3. Untuk pekerjaan pondasi pada proyek ini menggunakan pondasi tiang pancang. Karena setelah dilakukan penelitian tentang daya dukung tanah, letak tanah keras relatif dalam dari permukaan tanah (± 10 m). Pada perhitungan harga tiang pancang tidak dihitung secara detail dan hanya berdasarkan wawancara dengan pihak perencana proyek mengenai kebutuhan tiang pancang (m'), dan untuk upah pekerja berdasarkan upah borongan. Pada pekerjaan tiang pancang, harga satuan upah borongan sudah termasuk dengan mobilisasi alat dan pemancangan. Dengan menggunakan pondasi tiang pancang maka harga pekerjaan untuk pondasi menjadi lebih mahal. Prosentase harga pekerjaan pondasi tiang pancang terhadap total biaya pekerjaan struktural adalah :

$$\frac{319.200.000,00}{3.293.752.443,37} \times 100 \% = 9,6911 \%$$

- Prosentase harga pekerjaan poer pile terhadap total biaya pekerjaan struktural adalah :

$$\frac{85.470.755,59}{3.293.752.443,37} \times 100 \% = 2,5949 \%$$

4. Untuk pekerjaan cetakan beton pada pekerjaan poer pile menggunakan pasangan batako sehingga tidak perlu dibongkar dan dapat langsung di urug, sedangkan pada pekerjaan sloof, kolom, balok, dan pelat digunakan cetakan kayu. Pada pekerjaan bekisting menggunakan multipleks (1,22mx2,44m) sebagai bekisting kontak. Bahan bekisting diusahakan seefisien mungkin dalam penggunaannya untuk menekan anggaran biaya. Misalkan pada bekisting pelat (3,6mx3,6m), luasan pelat aktual 3,075m x 3,075m multipleks yang digunakan sebanyak 3,5 lembar dari 4 lembar dan sisa 0,5 lembar dapat digunakan untuk pekerjaan pelat yang lainnya. Balok 40/60 , tinggi bersih balok yaitu tinggi balok dikurangi tinggi pelat (12cm) menjadi 48 cm. Multipleks yang digunakan yaitu untuk 1 lembar multipleks di potong tiap 48 cm untuk bekisting sisi samping (tinggi balok 48 cm) dan untuk sisi bawah (lebar balok 40 cm), 1 lembar multipleks di potong tiap 40 cm. Untuk rangka pengaku bekisting digunakan kayu kruing ukuran 8/12, 6/12, 5/10 dan 5/7. Untuk perancah menggunakan scaffolding yang di pasang sedemikian rupa agar mampu menahan beban adukan beton dan bebar kerja. Scaffolding harus diletakkan di atas landasan papan kayu setebal 2 cm, agar tidak terjadi penurunan pada saat pencoran.

5. Pada pekerjaan pencoran untuk struktur beton bertulang menggunakan beton *ready mix* dengan mutu beton $f_c' = 25 \text{ MPa}$. Digunakan beton *ready mix* karena banyak pertimbangan-pertimbangan yang diambil antara lain untuk beton *ready mix* mutunya sudah terjamin karena beton sudah melalui proses pengujian desak beton dengan membuat benda uji silinder beton untuk mencapai mutu beton $f_c' = 25 \text{ MPa}$, sedangkan untuk mengetahui kekentalan adukan yang baik, perlu dilakukan pengujian *slump* 8-12 cm. Untuk beton lantai kerja menggunakan campuran dengan perbandingan 1pc:3ps:5kr. Campuran dikerjakan di tempat dengan menggunakan adukan beton (molen). Penempatan molen ini diusahakan sedekat mungkin dengan tempat bahan susun dan tempat yang akan di cor. Hal ini untuk memanfaatkan waktu pengangkutan seefisien mungkin. Upah cor beton *site mix* lebih mahal dibandingkan *ready mix* karena waktu dalam pengerjaannya dan pengangkutan adukan beton ke tempat yang akan di cor lebih lama. Pada pekerjaan beton balok lantai di dapat biaya yang paling besar dibandingkan pekerjaan-pekerjaan beton yang lain. Karena balok mempunyai tipe yang bervariasi dan jumlah tipe yang banyak sehingga volume yang di dapat juga besar.

- Prosentase harga pekerjaan balok terhadap total biaya pekerjaan struktural adalah :

$$\frac{1.220.089.280,55}{3.293.752.443,37} \times 100 \% = 37,0425 \%$$

- Prosentase harga pekerjaan kolom terhadap total biaya pekerjaan struktural adalah :

$$\frac{670.044.745,21}{3.293.752.443,37} \times 100 \% = 20,3429 \%$$

- Prosentase harga pekerjaan pelat terhadap total biaya pekerjaan struktural adalah :

$$\frac{651.921.709,83}{3.293.752.443,37} \times 100 \% = 19,7927 \%$$

- Prosentase harga pekerjaan balok sloof terhadap total biaya pekerjaan struktural adalah :

$$\frac{94.976.480,89}{3.293.752.443,37} \times 100 \% = 2,8835 \%$$

- Prosentase harga pekerjaan ring balk terhadap total biaya pekerjaan struktural adalah :

$$\frac{16.106.522,81}{3.293.752.443,37} \times 100 \% = 0,4890 \%$$

- Prosentase harga pekerjaan lantai kerja terhadap total biaya pekerjaan struktural adalah :

$$\frac{11.161.698,49}{3.293.752.443,37} \times 100 \% = 0,3389 \%$$

6. Untuk jenis besi tulangan pokok yang dipakai adalah besi tulangan ulir karena besi yang berbentuk ulir lebih merekat dengan cor beton sehingga diperoleh konstruksi yang lebih kuat. Menurut Peraturan Beton Bertulang Indonesia (PBBI 1971), kait-kait sengkang harus berupa kait yang miring, yang melingkari batang-batang sudut dan mempunyai bagian yang lurus

b. Lantai 2 ke lantai 3

- Pekerjaan Kolom

Pekerjaan kolom K3 dari lantai 2 ke lantai 3 mengalami penurunan biaya sebesar 4,65 %, angka ini diperoleh dari :

$$\frac{1.270.698,66 - 1.345.070,03}{1.270.698,66 + 1.345.070,03} = 4,65 \%$$

Pekerjaan kolom untuk tiap tipe kolom dari lantai 2 ke lantai 3 mengalami penurunan biaya yaitu kolom K1 3,37 %, K2 7,52 %, K4 5,51 %, K5 1,77 %, K6 2,25 %, K7 5,18 %, K8 3,94 %, K9 2,87 %, KM1 1,43 %, KM2 2,80 %, KM3 4,68 %, KL1 1,80 %, dan KL2 1,39 %. Hal ini dikarenakan kebutuhan tulangan kolom lantai 2 lebih besar daripada lantai 3.

- Pekerjaan Balok

Pekerjaan balok G1 dari lantai 2 ke lantai 3 mengalami penurunan biaya sebesar 1,50 %, angka ini diperoleh dari :

$$\frac{4.972.731,34 - 5.124.247,00}{4.972.731,34 + 5.124.247,00} = 1,50 \%$$

Pekerjaan balok B1 juga mengalami penurunan biaya sebesar 1,98 %. Hal ini disebabkan volume lantai 2 lebih besar daripada lantai 3. Tetapi untuk balok tipe lain dari lantai 2 ke lantai 3 mengalami kenaikan biaya yaitu untuk balok G2 sebesar 13,90 %, angka ini diperoleh dari :

$$\frac{2.299.298,18 - 1.738.265,31}{2.299.298,18 + 1.738.265,31} = 13,90 \%$$

Balok G3 mengalami kenaikan biaya sebesar 2,65 %, G4 4,27 %, G5 3,18 %, G6 5,33 %, G7 2,42 %, G8 1,35 %, G9 2,53 %, G10 2,53 %, G11 1,57 %, G12 2,48 %, G13 1,76 %, G14 1,70 %, G15 1,83 %, B2 1,46 %, B3 1,51 %, B4 8,79 %, dan B5 12,50 %.

- Pekerjaan Pelat Lantai

Pekerjaan pelat P1 dari lantai 2 ke lantai 3 mengalami penurunan biaya sebesar 6,56 %, angka ini diperoleh dari :

$$\frac{18.709.444,33 - 17.643.553,47}{18.709.444,33 + 17.643.553,47} = 6,56 \%$$

Pelat P2 mengalami kenaikan biaya sebesar :

$$\frac{14.102.352,07 - 13.364.793,00}{14.102.352,07 + 13.364.793,00} = 2,69 \%$$

Pelat P2 juga mengalami kenaikan biaya sebesar 3,09 % dan pelat P3 mengalami kenaikan biaya sebesar 3,40 %.

c. Lantai 3 ke lantai atap

- Pekerjaan Balok

Pekerjaan balok G1 dari lantai 3 ke lantai atap mengalami kenaikan biaya sebesar 16,75 %, angka ini diperoleh dari :

$$\frac{6.973.438,64 - 4.972.731,34}{6.973.438,64 + 4.972.731,34} = 16,75 \%$$

Pekerjaan balok untuk tiap tipe balok dari lantai 3 ke lantai atap juga mengalami kenaikan biaya yaitu balok G3 mengalami kenaikan sebesar 1,11 %, G4 3,09 %, G5 7,58 %, G6 1,24 %, G7

1,72 %, G8 2,36 %, G9 1,18 %, G10 3,25 %, G11 2,38 %, G13 2,55 %, G14 2,53 %, G15 2,58 %, B1 9,80 %, B2 2,63 %, B3 8,36 %, dan B5 9,75 %. Sedangkan yang mengalami penurunan biaya hanya pada balok G2 sebesar 9,46 % dan balok B4 sebesar 10,33 %.

- Pekerjaan Pelat Lantai

Pekerjaan pelat P1 dari lantai 3 ke lantai atap mengalami penurunan biaya sebesar 2,33 %, angka ini diperoleh dari :

$$\frac{17.857.861,58 - 18.709.444,33}{17.857.861,58 + 18.709.444,33} = 2,33 \%$$

Hal ini dikarenakan volume pelat pada lantai 3 lebih besar daripada pelat lantai atap.

Keterangan :

Harga upah tiap pekerjaan = volume pekerjaan x harga satuan upah

BAB VII

KESIMPULAN DAN SARAN

.1. Kesimpulan

Dari hasil perhitungan dan pembahasan yang telah dilakukan maka dapat diperoleh beberapa kesimpulan antara lain :

1. Dari hasil perhitungan diperoleh total anggaran biaya pada pekerjaan struktural proyek sebesar Rp. 3.293.752.443,37.
2. Pekerjaan urugan mempunyai volume yang cukup besar dan biaya yang dibutuhkan cukup besar juga. Karena letak lantai dasar (0,00) terletak 2 m di atas permukaan tanah asli. Biaya untuk pekerjaan urugan adalah Rp. 224.781.250,00. Prosentase pekerjaan urugan 6,8245 %.
3. Pekerjaan pondasi menggunakan pondasi tiang pancang. Karena setelah dilakukan penelitian tentang daya dukung tanah, letak tanah keras relatif dalam dari permukaan tanah (± 10 m). Biaya untuk pekerjaan pondasi tiang pancang adalah Rp. 319.200.000,00, sedangkan prosentase pekerjaan pondasi tiang pancang 9,6911 %, poer pile 2,5949 %, sloof 2,8835 % dan lantai kerja 0,3389 %.
4. Pada pekerjaan bekisting diusahakan penggunaan material seefektif mungkin dan menggunakan material yang dapat dimanfaatkan lagi.

Misalkan pada pekerjaan bekisting pelat (3,6mx3,6m), dibutuhkan 3,5 lembar dari 4 lembar multipleks, dan sisa 0,5 lembar dapat digunakan untuk bekisting pelat yang lain dengan tipe yang sama. Balok 40/60 multipleks yang digunakan yaitu untuk 1 lembar multipleks di potong tiap 48 cm untuk bekisting sisi samping (tinggi balok 48 cm) dan untuk sisi bawah (lebar balok 40 cm), 1 lembar multipleks di potong tiap 40 cm.

5. Pada pekerjaan pencoran untuk struktur beton bertulang menggunakan beton *ready mix* dengan mutu beton $f_c' 25 \text{ Mpa}$. Pekerjaan beton balok lantai mempunyai prosentase yang paling besar yaitu 37,0425 % karena balok mempunyai volume yang besar pada tiap lantainya dan tipe yang bervariasi, sedangkan prosentase pada pekerjaan beton pelat 19,7927 %, kolom 20,3429 %, ring balk 0,4890 %.
6. Pada pekerjaan tiap lantai terdapat kenaikan maupun penurunan biaya. Untuk pekerjaan kolom lantai 1 ke lantai 2 mengalami penurunan biaya dengan rata-rata sebesar 6,18 % dan kolom lantai 2 ke lantai 3 mengalami penurunan biaya rata-rata sebesar 3,52 %. Pekerjaan balok lantai 2 ke lantai 3 mengalami kenaikan biaya dengan rata-rata sebesar 4 % dan balok lantai 3 ke atap mengalami kenaikan biaya rata-rata sebesar 4,64 %. Pekerjaan pelat lantai 2 ke lantai 3 mengalami kenaikan biaya dengan rata-rata sebesar 3,06 % dan dari lantai 3 ke lantai atap mengalami penurunan biaya sebesar 2,33 %.

7.2. Saran-saran

Dari hasil pembahasan dan pengamatan langsung di lapangan terdapat beberapa hal yang dapat diberikan saran dalam pelaksanaan pekerjaan struktural, antara lain :

1. Bahan bangunan terutama baja tulangan sebaiknya disimpan pada daerah yang aman atau terlindung dari gangguan cuaca yang dapat menyebabkan penurunan kualitas baja tulangan akibat korosi, misalnya dengan cara menutup baja tulangan dengan terpal sehingga terlindung dari hujan dan sinar matahari.
2. Dalam pelaksanaan pekerjaan hendaknya dilakukan secermat mungkin dan diperlukan pengawasan yang lebih optimal sehingga didapatkan hasil sesuai perencanaan.
3. Pada saat pelaksanaan pekerjaan bekisting diharapkan pemakaian bahan sedapat mungkin menggunakan bahan yang dapat dimanfaatkan lagi dan dalam pembongkaran harus lebih berhati-hati karena bahan bekisting dapat digunakan sebanyak tiga kali untuk setiap pekerjaan dengan tipe yang sama.
4. Diharapkan untuk Tugas Akhir selanjutnya dengan topik yang sama, perlu dikaji tentang berapa besarnya rencana anggaran biaya pada pekerjaan arsitektural dan mekanikal elektrik karena item pekerjaan tersebut lebih bervariasi dan memerlukan kecermatan dalam perhitungan anggaran biayanya.

DAFTAR PUSTAKA

1. A. Soedrajat Sastraatmaja, 1984, **Analisa Anggaran Biaya Pelaksanaan**, Penerbit Nova, Bandung.
2. Bachtiar Ibrahim, 1993, **Rencana dan Estimate Real of Cost**, Penerbit Bumi Aksara, Jakarta.
3. Denny Hermawan, 2002, **Studi Analisa RAB Pada Konstruksi Gedung Dengan Metoda B.O.W dan Non B.O.W.**
4. Iman Soeharto, 1997, **Manajemen Proyek Dari Konseptual Sampai Operasional**, Penerbit Erlangga, Jakarta.
5. Puteri Paramita, 2003, **Studi Analisa Biaya Pelaksanaan Pekerjaan Struktur Pada Konstruksi Gedung Bertingkat.**
6. **Peraturan Beton Bertulang Indonesia**, 1971, **N.I-2**, Cetakan Ketujuh, Direktorat Jenderal Cipta Karya, Departemen Pekerjaan Umum Dan Listrik.
7. Sugeng Djojowiriono, 1991, **Manajemen Konstruksi**, Jilid Pertama Edisi Kedua, Biro Penerbit KMTS, UGM, Yogyakarta.
8. Supriyatno, 2002, **RAB Proyek Bangunan Gedung**, Pusat Pengembangan Sumber Daya Manusia, SENSEA, Yogyakarta.
9. W, Niron John, 1990, **Rencana Anggaran Biaya Bangunan**, Cetakan kedelapan, CV. Asona, Jakarta.

KARTU PUSKOPOLITIKAS AKHIR

NO. KITAS

NO. STUDI

98 311 299

1998 311 299

98 311 276

1998 311 276

PERIODE

15 April 2004 - 15 April 2004

PERIODE 15 APRIL 2004 - 15 APRIL 2004

PERIODE 15 APRIL 2004 - 15 APRIL 2004

PERIODE

PERIODE

PERIODE

PERIODE

PERIODE

PERIODE

PERIODE

PERIODE

PERIODE 15 APRIL 2004 - 15 APRIL 2004

PERIODE 15 APRIL 2004 - 15 APRIL 2004

PERIODE 15 APRIL 2004 - 15 APRIL 2004



PERIODE 15 APRIL 2004 - 15 APRIL 2004

PERIODE 15 APRIL 2004 - 15 APRIL 2004

PERIODE 15 APRIL 2004 - 15 APRIL 2004

Handwritten signature and date: 25-2-04



الجامعة الإسلامية

UNIVERSITAS ISLAM INDONESIA
FAKULTAS TEKNIK SIPIL DAN PERENCANAAN

JURUSAN : TEKNIK SIPIL, ARSITEKTUR, TEKNIK LINGKUNGAN
KAMPUS : Jalan Kaliurang KM 14,4 Telp. (0274) 895042, 895707, 896440. Fax: 895330
Email : dekanat@ftsp.uii.ac.id. Yogyakarta Kode Pos 55584

FM-UII-AA-FPU-09

Nomor : : 33 /Kajur.TS.20/ Bg.Pn./X/2003
Lamp. : -
Hal : : BIMBINGAN TUGAS AKHIR
Periode : : 1 (Sep - Peb 2004)

Jogjakarta, 9-Dec-03

Kepada .
Yth. Bapak / Ibu : Tadjuddin BMA,Ir,H,MT
di -
Jogjakarta

Assalamu'alaikum Wr.Wb.

Dengan ini kami mohon dengan hormat kepada Bapak / Ibu Agar Mahasioswa Jurusan Teknik Sipil, Fakultas Teknik Sipil dan Perencanaan tersebut di bawah ini :

- 1 Nama : Woro Palupi A A
No. Mhs. : 98 511 291
Bidang Studi : Teknik Sipil
Tahun Akademi : 2003 - 2004
- 2 Nama : Noviko Thaufik
No. Mhs. : 98 511 243
Bidang Studi : Teknik Sipil
Tahun Akademi : 2003 - 2004

Dapat diberikan petunjuk- petunjuk, pengarahan serta bimbingan dalam melaksanakan Tugas Akhir. Kedua Mahasiswa tersebut merupakan satu kelompok dengan dosen pembimbing sebagai berikut :

Dosen Pembimbing I	: Tadjuddin BMA,Ir,H,MT
Dosen Pembimbing II	:

Dengan Mengambil Topik /Judul :

Perencanaan Rencana Anggaran Biaya Pada Konstruksi Gedung

Demikian atas bantuan serta kerjasamanya diucapkan terima kasih

Wassalamu'alaikum Wr.Wb.

An.Dekan
Ketua Jurusan Teknik Sipil

M.H. Munadhir, MS

Tembusan

- 1) Dosem Pembimbing ybs
- 2) Mahasiswa ybs
- 3) Arsip.



السلامة الإسلامية

UNIVERSITAS ISLAM INDONESIA
FAKULTAS TEKNIK SIPIL DAN PERENCANAAN

JURUSAN : TEKNIK SIPIL, ARSITEKTUR, TEKNIK LINGKUNGAN
KAMPUS : Jalan Kaliurang KM 14,4 Telp. (0274) 895042, 895707, 896440. Fax: 895330
Email : dekanat@ftsp.uii.ac.id. Yogyakarta Kode Pos 55584

Nomor : 145 /Dek.70/FTSP/09/2003
Lamp. : -
Hal : **Permohonan data TA**

Jogjakarta, 15-Okt-03

Kepada Yth **Proyek Maneger Pembangunan Masjid**
Kampus Universitas Muhammadiyah Yogyakarta
di -
Jogjakarta

Assalamu'alaikum Wr.Wb.

Sehubungan dengan Tugas Akhir yang akan dilaksanakan oleh mahasiswa kami, **Jurusan Teknik Sipil Fakultas Teknik Sipil Dan Perencanaan Universitas Islam Indonesia Yogyakarta** yang bernama sbb :

No	Nama	No.Mhs
1.	Noviko Thaufik	98 511 243
2.	Woro Palupi	98 511 291

Berkenaan hal tersebut kiranya mahasiswa memerlukan **informasi / data / bahan / ijin penelitian**. Untuk mendukung penyusunan Tugas Akhir, maka dengan ini kami mohon kepada Bapak/ Ibu sudilah kiranya dapat memberikan bantuan yang diperlukan untuk menyelesaikan Tugas Akhir.

Demikian permohonan kami , atas perkenan serta bantuan dan bimbingannya diucapkan banyak terima kasih.

Wassalamu' alaikum Wr.Wb



Prof. Ir. H. Widodo, MSCE, Ph.D

Tembusan :

- Mahasiswa ybs
- Arsip.

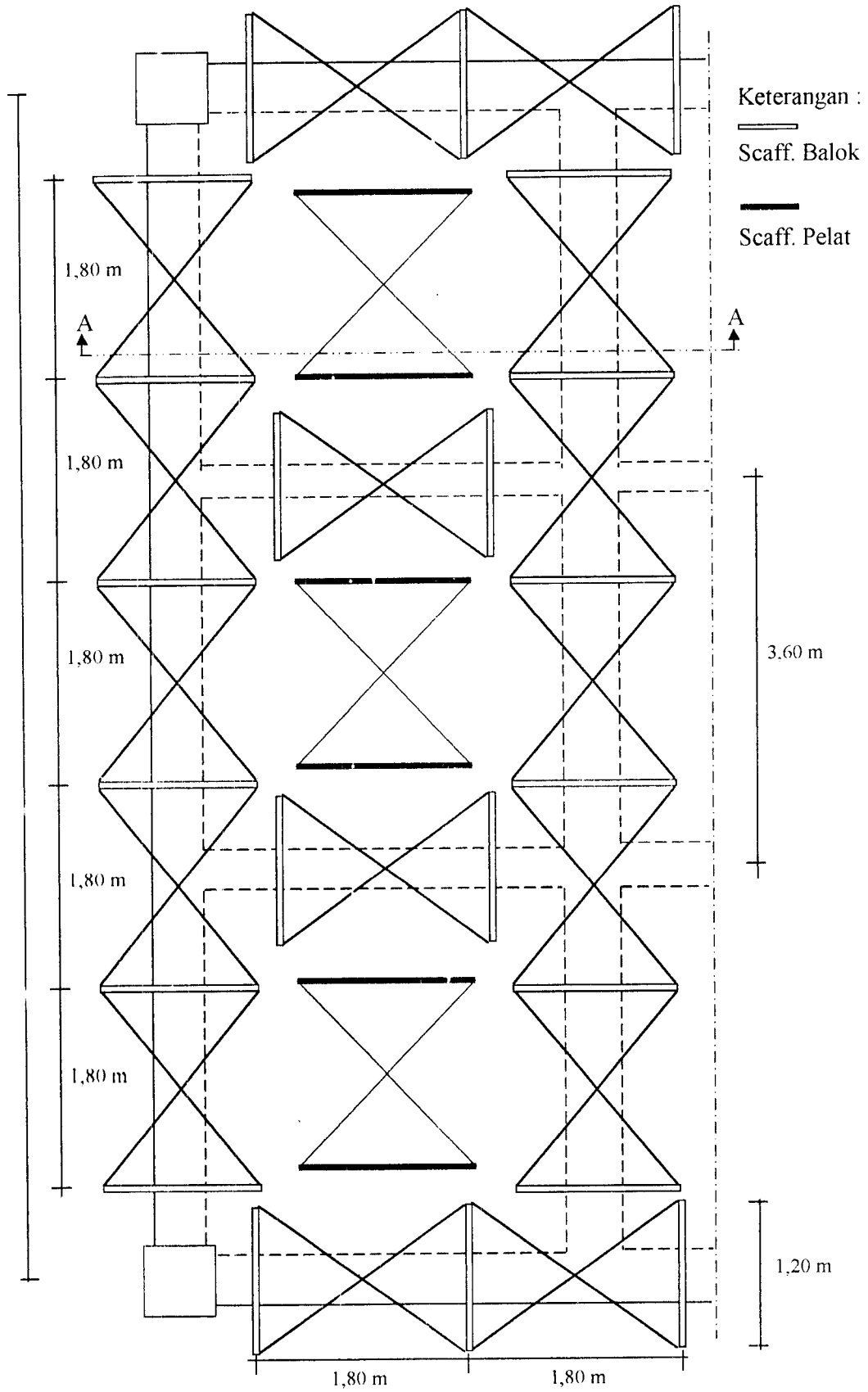

DENAH PENEMPATAN SCAFFOLDING BALOK DAN PELAT

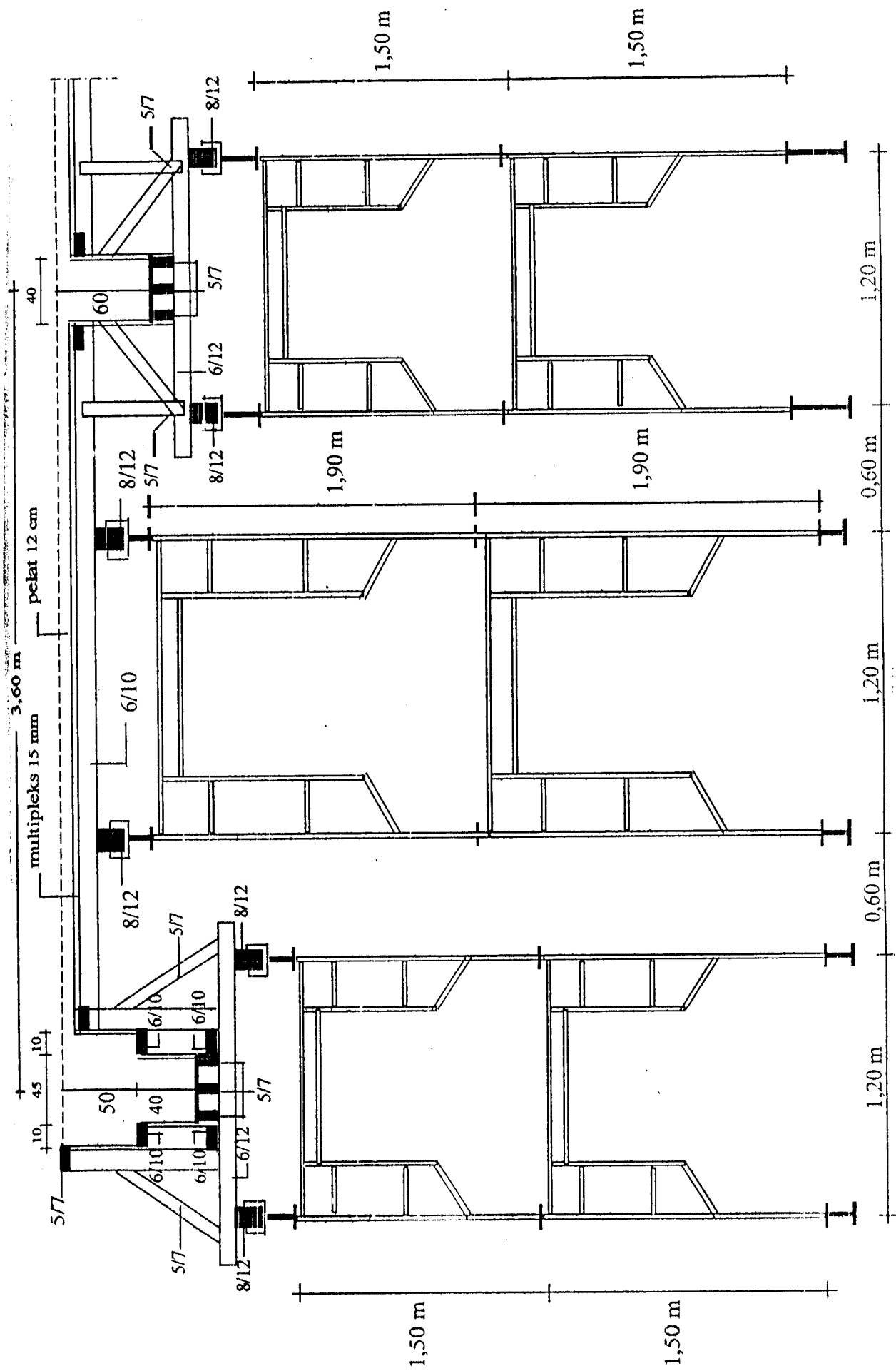

POTONGAN A

LAMPIRAN 4

Perhitungan Volume Beton Poer Pile

No	Tipe	Panjang Poer (m)	Lebar Poer (m)	Tinggi Poer (m)	Tinggi Cor (m)	Lebar Batako (m)	Volume Beton Poer (m ³)	Jumlah Tipe	Volume Total Beton Poer (m ³)
a	b	c	d	e	f	g	$h = (c - (2 * g)) * (d - (2 * g)) * f$	i	$j = h * i$
1	2	1.80	1.00	0.60	0.60	0.10	0.77	12	9.22
2	3	1.69	1.69	0.60	0.60	0.10	1.33	8	10.66
3	4	1.80	1.80	0.80	0.65	0.10	1.66	16	26.62
4	5	2.13	2.13	0.80	0.65	0.10	2.42	6	14.53
5	7	2.39	2.60	0.80	0.80	0.10	4.20	6	25.23
6	9	2.60	2.60	1.00	0.90	0.10	5.18	8	41.47
7	12	3.40	2.60	1.00	0.90	0.10	6.91	2	13.82
<i>Jumlah</i>							22.49	58	141.55

Perhitungan Volume Bekisting Pasangan Batako Poer Pile

No	Tipe	Panjang Poer (m)	Lebar Poer (m)	Tinggi Poer (m)	Lebar Batako (m)	Volume Bekisting Pasangan Batako (m ²)	Jumlah Tipe	Volume Total Bekisting Batako (m ²)
a	b	c	d	e	f	$g = (c * e * 2) + ((d - (2 * g)) * e * 2)$	h	$i = g * h$
1	2	1.80	1.00	0.60	0.10	3.12	12	37.44
2	3	1.69	1.69	0.60	0.10	3.82	8	30.53
3	4	1.80	1.80	0.80	0.10	5.44	16	87.04
4	5	2.13	2.13	0.80	0.10	6.50	6	38.98
5	7	2.39	2.60	0.80	0.10	7.66	6	45.98
6	9	2.60	2.60	1.00	0.10	10.00	8	80.00
7	12	3.40	2.60	1.00	0.10	11.60	2	23.20
<i>Jumlah</i>						48.14	58	343.17

Kebutuhan Besi Tulangan Pokok Poer Pile

No	Type Poer	Panjang Bersih (m)	Lebar Bersih (m)	Tinggi Poer (m)	Selimut Beton (m)	φ Besi	Jarak antar Tulangan (m)	Panjang Tulangan (m)	Jml Tul. Arak Panjang Poer	Jml Tul. Arak Lebar Poer	Jml Tul. Arak Tinggi Poer	Jumlah Total Tulangan	Besi Tulangan (kg/m)	Berat Tulangan (kg)	Jumlah Tipe	Berat Total Tulangan (kg)
a	b	c	d	e	f	g	h	i	$j = ((c-2*f)/h)+1$	$k = ((d-2*f)/h)+1$	$l = ((e-2*f)/h)+1$	m	n	$o = i*m*n$	p	$q = o * p$
1	2	1.60	0.80	0.60	0.05	P 12	0.20	2.30	-	5	-	5	0.89	10.24	12	122.82
		1.60	0.80	0.60	0.05	D 19	0.24	1.60	-	4	-	4	2.23	14.27	12	171.26
		1.60	0.80	0.60	0.05	P 12	0.20	1.50	9	-	-	9	0.89	12.02	12	144.18
		1.60	0.80	0.60	0.05	D 19	0.24	0.80	8	-	-	8	2.23	14.27	12	171.26
		1.60	0.80	0.60	0.05	P 12	0.25	4.70	-	-	3	3	0.89	12.55	12	150.59
Jumlah													63.34			760.12
2	3	1.49	1.49	0.60	0.05	P 12	0.20	1.49	-	8	-	8	0.89	10.61	8	84.87
		1.49	1.49	0.60	0.05	D 19	0.15	2.09	-	11	-	11	2.23	51.27	8	410.14
		1.49	1.49	0.60	0.05	P 12	0.20	2.09	8	-	-	8	0.89	14.88	8	119.05
		1.49	1.49	0.60	0.05	D 19	0.15	1.49	11	-	-	11	2.23	36.55	8	292.40
		1.49	1.49	0.60	0.05	P 12	0.25	5.86	-	-	3	3	0.89	15.65	8	125.17
Jumlah													128.95			1031.63
3	4	1.60	1.60	0.65	0.05	P 12	0.20	2.40	-	9	-	9	0.89	19.22	16	307.58
		1.60	1.60	0.65	0.05	D 19	0.24	1.60	-	8	-	8	2.23	28.54	16	456.70
		1.60	1.60	0.65	0.05	P 12	0.20	2.40	9	-	-	9	0.89	19.22	16	307.58
		1.60	1.60	0.65	0.05	D 19	0.24	1.60	8	-	-	8	2.23	28.54	16	456.70
		1.60	1.60	0.65	0.05	P 12	0.25	6.30	-	-	4	4	0.89	22.43	16	358.85
Jumlah													117.96			1887.42
4	5	1.93	1.93	0.65	0.05	P 12	0.20	2.73	-	11	-	11	0.89	26.73	6	160.36
		1.93	1.93	0.65	0.05	D 19	0.25	1.93	-	9	-	9	2.23	38.74	6	232.41
		1.93	1.93	0.65	0.05	P 12	0.20	2.73	11	-	-	11	0.89	26.73	6	160.36
		1.93	1.93	0.65	0.05	D 19	0.25	1.93	9	-	-	9	2.23	38.74	6	232.41
		1.93	1.93	0.65	0.05	P 12	0.30	7.62	-	-	3	3	0.89	20.35	6	122.07
Jumlah													151.27			907.61

5	7	2.19	2.40	0.80	0.05	P 12	0.20	3.19	-	13	-	13	0.89	36.91	6	221.45
		2.19	2.40	0.80	0.05	D 19	0.16	2.19	-	16	-	16	2.23	78.14	6	468.84
		2.19	2.40	0.80	0.05	P 12	0.20	3.19	12	-	-	12	0.89	34.07	6	204.42
		2.19	2.40	0.80	0.05	D 19	0.16	2.19	14	-	-	14	2.23	68.37	6	410.23
		2.19	2.40	0.80	0.05	P12	0.30	9.08	-	-	4	4	0.89	32.32	6	193.95
													<i>Jumlah</i>	<i>249.81</i>		<i>1498.88</i>
6	9	2.40	2.40	0.90	0.05	P 12	0.20	3.60	-	13	-	13	0.89	41.65	8	333.22
		2.40	2.40	0.90	0.05	D 19	0.16	2.40	-	16	-	16	2.23	85.63	8	685.06
		2.40	2.40	0.90	0.05	P 12	0.20	3.60	13	-	-	13	0.89	41.65	8	333.22
		2.40	2.40	0.90	0.05	D 19	0.16	2.40	16	-	-	16	2.23	85.63	8	685.06
		2.40	2.40	0.90	0.05	P12	0.30	9.50	-	-	4	4	0.89	33.82	8	270.56
													<i>Jumlah</i>	<i>288.39</i>		<i>2307.10</i>
7	12	3.20	2.40	0.90	0.05	P 12	0.20	4.40	-	13	-	13	0.89	50.91	2	101.82
		3.20	2.40	0.90	0.05	D 19	0.16	3.20	-	16	-	16	2.23	114.18	2	228.35
		3.20	2.40	0.90	0.05	P 12	0.20	3.60	17	-	-	17	0.89	54.47	2	108.94
		3.20	2.40	0.90	0.05	D 19	0.16	2.40	21	-	-	21	2.23	112.39	2	224.78
		3.20	2.40	0.90	0.05	P12	0.30	11.10	-	-	4	4	0.89	39.52	2	79.03
													<i>Jumlah</i>	<i>371.46</i>		<i>742.92</i>

Rekapitulasi Kebutuhan Besi Tulangan Ujir dan Polos Poer Pile

No	Tipe Poer	ε Besi	Jarak antar Tulangan (m)	Panjang Tulangan (m)	Jumlah Tulangan (kg)	Besi (kg/m)	Berat Tulangan (kg)	Total Berat Tul. (kg)	Volume Beton (m ³)	Konversi Tul. dim 1m ³ Beton (kg)	Besi (kg)	Bendrat (koef bhxbrt tul) (kg)
a	b	c	d	e	f	g	h = e * f * g	i = Σ h	j	k = (1/j) * i	l = 1.10 * k	m = 0.02 * k
1	2	P 12	0.20	2.30	5	0.89	10.24	34.80	0.77	45.19	49.71	0.90
		P 12	0.20	1.50	9	0.89	12.02					
		P 12	0.25	4.70	3	0.89	12.55					
		D 19	0.24	1.60	4	2.23	14.27					
		D 19	0.24	0.80	8	2.23	14.27					
2	3	P 12	0.20	1.49	8	0.89	10.61	41.14	1.33	30.93	34.02	0.62
		P 12	0.20	2.09	8	0.89	14.88					
		P 12	0.25	5.86	3	0.89	15.65					
		D 19	0.15	2.09	11	2.23	51.27					
		D 19	0.15	1.49	11	2.23	36.55					
3	4	P 12	0.20	2.40	9	0.89	19.22	60.88	1.66	36.67	40.34	0.73
		P 12	0.20	2.40	9	0.89	19.22					
		P 12	0.25	6.30	4	0.89	22.43					
		D 19	0.24	1.60	8	2.23	28.54					
		D 19	0.24	1.60	8	2.23	28.54					
4	5	P 12	0.20	2.73	11	0.89	26.73	73.80	2.42	30.50	33.54	0.61
		P 12	0.20	2.73	11	0.89	26.73					
		P 12	0.30	7.62	3	0.89	20.35					
		D 19	0.25	1.93	9	2.23	38.74					
		D 19	0.25	1.93	9	2.23	38.74					

5		P 12	0.20	3.19	13	0.89	36.91	103.30	4.20	24.60	27.06	0.49
	7	P 12	0.20	3.19	12	0.89	34.07					
		P 12	0.30	9.08	4	0.89	32.32					
		D 19	0.16	2.19	16	2.23	78.14	146.51	4.20	34.88	38.37	0.70
		D 19	0.16	2.19	14	2.23	68.37					
6		P 12	0.20	3.60	13	0.89	41.65					
	9	P 12	0.20	3.60	13	0.89	41.65	117.12	5.18	22.61	24.87	0.45
		P 12	0.30	9.50	4	0.89	33.82					
		D 19	0.16	2.40	16	2.23	85.63	171.26	5.18	33.06	35.37	0.66
		D 19	0.16	2.40	16	2.23	85.63					
7		P 12	0.20	4.40	13	0.89	50.91					
	12	P 12	0.20	3.60	17	0.89	54.47	144.89	6.91	20.97	23.07	0.42
		P 12	0.30	11.10	4	0.89	39.52					
		D 19	0.16	3.20	16	2.23	114.18	226.57	6.91	32.79	36.07	0.66
		D 19	0.16	2.40	21	2.23	112.39					

**DAFTAR ANALISA HARGA SATUAN
PEKERJAAN POER PILE**

No	Uraian	Volume	Sat.	Harga Satuan (Rp)	Analisa Harga Bahan (Rp)	Analisa Harga Upah (Rp)	Total Harga Analisa (Rp)
IV	PEKERJAAN BETON POER PILE						
1	POER PILE TIPE 2						
	BAHAN						
	Beton ready mix K-250	1.00	m ³	274,000.00	274,000.00		
	Besi ulir	40.78	kg	3,350.00	136,613.00		
	Besi polos	49.71	kg	3,000.00	149,130.00		
	Bendrat	1.64	kg	6,500.00	10,660.00		
	Batako	49.00	buah	900.00	44,100.00		
	Semen PC	0.94	zak	22,500.00	21,242.25		
	Pasir	0.03	m ³	40,000.00	1,264.00		637,009.25
	UPAH BORONGAN						
	Cor ready mix	1.00	m ³	32,500.00		32,500.00	
	Buat + stel besi	90.49	kg	200.00		18,098.00	
	Bekisting pas. Batako	4.05	m ²	4,500.00		18,225.00	68,823.00
					Jumlah		705,832.25
					Dibulatkan		705,832.00
2	POER PILE TIPE 3						
	BAHAN						
	Beton ready mix K-250	1.00	m ³	274,000.00	274,000.00		
	Besi ulir	72.63	kg	3,350.00	243,310.50		
	Besi polos	34.02	kg	3,000.00	102,060.00		
	Bendrat	1.94	kg	6,500.00	12,610.00		
	Batako	35.00	buah	900.00	31,500.00		
	Semen PC	0.67	zak	22,500.00	15,050.25		
	Pasir	0.02	m ³	40,000.00	896.00		679,426.75
	UPAH BORONGAN						
	Cor ready mix	1.00	m ³	32,500.00		32,500.00	
	Buat + stel besi	106.65	kg	200.00		21,330.00	
	Bekisting pas. Batako	2.87	m ²	4,500.00		12,915.00	66,745.00
					Jumlah		746,171.75
					Dibulatkan		746,172.00
3	POER PILE TIPE 4						
	BAHAN						
	Beton ready mix K-250	1.00	m ³	274,000.00	274,000.00		
	Besi ulir	37.83	kg	3,350.00	126,730.50		
	Besi polos	40.34	kg	3,000.00	121,020.00		
	Bendrat	1.42	kg	6,500.00	9,230.00		
	Batako	40.00	buah	900.00	36,000.00		
	Semen PC	0.76	zak	22,500.00	17,203.50		
	Pasir	0.03	m ³	40,000.00	1,024.00		585,208.00
	UPAH BORONGAN						
	Cor ready mix	1.00	m ³	32,500.00		32,500.00	
	Buat + stel besi	78.17	kg	200.00		15,634.00	
	Bekisting pas. Batako	3.28	m ²	4,500.00		14,760.00	62,894.00
					Jumlah		648,102.00
					Dibulatkan		648,102.00

BAHAN	1.00	m ³	274,000.00	274,000.00		
Beton ready mix K-250	35.21	kg	3,350.00	117,953.50		
Besi ulir	33.54	kg	3,000.00	100,620.00		
Besi polos	1.25	kg	6,500.00	8,125.00		
Bendrat	33.00	buah	900.00	29,700.00		
Batako	0.63	zak	22,500.00	14,109.75		545,348.25
Semen PC	0.02	m ³	40,000.00	840.00		
Pasir					32,500.00	
UPAH BORONGAN	1.00	m ³	32,500.00	13,750.00		58,355.00
Cor ready mix	68.75	kg	200.00	12,105.00		
Buat + stel besi	2.69	m ²	4,500.00			603,703.25
Bekisting pas. I atako						603,703.00
				Jumlah		
				Dibulatkan		

5 POER PILE TIPE 7						
BAHAN	1.00	m ³	274,000.00	274,000.00		
Beton ready mix K-250	38.37	kg	3,350.00	128,539.50		
Besi ulir	27.06	kg	3,000.00	81,180.00		
Besi polos	1.19	kg	6,500.00	7,735.00		
Bendrat	22.00	buah	900.00	19,800.00		
Batako	0.43	zak	22,500.00	9,598.50		521,425.00
Semen PC	0.01	m ³	40,000.00	572.00		
Pasir					32,500.00	
UPAH BORONGAN	1.00	m ³	32,500.00	13,086.00		53,821.00
Cor ready mix	65.43	kg	200.00	8,235.00		
Buat + stel besi	1.83	m ²	4,500.00			575,246.00
Bekisting pas. Batako						575,246.00
				Jumlah		
				Dibulatkan		

6 POER PILE TIPE 9						
BAHAN	1.00	m ³	274,000.00	274,000.00		
Beton ready mix K-250	36.37	kg	3,350.00	121,839.50		
Besi ulir	24.87	kg	3,000.00	74,610.00		
Besi polos	1.11	kg	6,500.00	7,215.00		
Bendrat	17.00	buah	900.00	15,300.00		
Batako	0.31	zak	22,500.00	6,975.00		500,355.50
Semen PC	0.01	m ³	40,000.00	416.00		
Pasir					32,500.00	
UPAH BORONGAN	1.00	m ³	32,500.00	12,248.00		50,753.00
Cor ready mix	61.24	kg	200.00	5,985.00		
Buat + stel besi	1.33	m ²	4,500.00			551,088.50
Bekisting pas. Batako						551,089.00
				Jumlah		
				Dibulatkan		

7 POER PILE TIPE 12						
BAHAN	1.00	m ³	274,000.00	274,000.00		
Beton ready mix K-250	36.07	kg	3,350.00	120,834.50		
Besi ulir	23.07	kg	3,000.00	69,210.00		
Besi polos	1.08	kg	6,500.00	7,020.00		
Bendrat	21.00	buah	900.00	18,900.00		
Batako	0.39	zak	22,500.00	8,811.00		499,299.50
Semen PC	0.01	m ³	40,000.00	524.00		
Pasir					32,500.00	
UPAH BORONGAN	1.00	m ³	32,500.00	11,828.00		51,888.00
Cor ready mix	59.14	kg	200.00	7,560.00		
Buat + stel besi	1.68	m ²	4,500.00			551,187.50
Bekisting pas. Batako						551,188.00
				Jumlah		
				Dibulatkan		

Perhitungan Kebutuhan Besi Tulangan Pokok Balok Sloof

Type	Jenis	φ Besi (m)	Jumlah Tulangan	Panjang Tulangan (m)	Kait (m)	Perpanjangan (m)	Besi (kg/m)	Kebutuhan Besi (m)	Berat Tulangan (kg)	Jumlah Tipe Sloof	Berat Total Tulangan (kg)
a	b	c	d	e	f = 5 * c	g = 40 * c	h	i = (e+f+g)*d	j = h * i	k	l = j * k
I.1 As 4-7(As D), As 7-8(As E,F,B), As 8-11(As D), As B-D(As 7,8), As D-E(As 4,7,8,11), As E-F(As 7,8) (As ke As = 10,80 m)											
S1	Tump. atas	0.019	4	3.29	0	0.76	2.23	16.20	36.13	13	469.64
	Tump. bawah	0.019	2	5.40	0.19	0.76	2.23	12.70	28.32	13	368.17
	Lap. atas	0.019	4	5.40	0	0.76	2.23	24.64	54.95	13	714.31
	Lap. bawah	0.019	2	7.51	0.19	0	2.23	15.40	34.34	13	446.45
	Susut	0.012	2	10.80	0	0.48	0.89	22.56	20.08	13	261.02
JUMLAH									288.97		3756.63
I.2 As E-F(As 4,11), As F-K(As 7,8) (As ke As = 10,80 m)											
S1	Tump. atas	0.019	4	4.64	0	0.76	2.23	21.60	48.17	4	192.67
	Tump. bawah	0.019	2	6.80	0.19	0.76	2.23	15.50	34.57	4	138.26
	Lap. atas	0.019	4	6.80	0	0.76	2.23	30.24	67.44	4	269.74
	Lap. bawah	0.019	2	7.56	0.19	0	2.23	15.50	34.57	4	138.26
	Susut	0.012	2	10.80	0	0.48	0.89	22.56	20.08	4	80.31
JUMLAH									320.41		1281.66
I.3 As 4-7(As E), As 8-11 (As E) (As ke As = 10,80 m)											
S1	Tump. atas	0.019	4	3.29	0	0.76	2.23	16.20	36.13	2	72.25
	Tump. bawah	0.019	2	5.40	0.19	0.76	2.23	12.70	28.32	2	56.64
	Lap. atas	0.019	4	5.40	0	0.76	2.23	24.64	54.95	2	109.89
	Lap. bawah	0.019	2	7.51	0.19	0	2.23	15.40	34.34	2	68.68
	Susut	0.012	2	10.80	0	0.48	0.89	22.56	20.08	2	40.16
JUMLAH									288.97		577.94
I.4 As 7-8 (As E) (As ke As = 10,80 m)											
S1	Tump. atas	0.019	4	3.39	0	0.76	2.23	16.60	37.02	1	37.02
	Tump. bawah	0.019	2	5.40	0.19	0.76	2.23	12.70	28.32	1	28.32
	Lap. atas	0.019	4	5.40	0	0.76	2.23	24.64	54.95	1	54.95
	Lap. bawah	0.019	2	7.41	0.19	0	2.23	15.20	33.90	1	33.90
	Susut	0.012	2	10.80	0	0.48	0.89	22.56	20.08	1	20.08
JUMLAH									288.53		288.53

I.5 As 7-8 (As K) (As ke As = 10.80 m)												
S1	Tump. atas	0.019	4	3.19	0	0.76	2.23	15.80	35.23	1	35.23	
	Tump. bawah	0.019	2	5.40	0.19	0.76	2.23	12.70	28.32	1	28.32	
	Lap. atas	0.019	4	5.40	0	0.76	2.23	24.64	54.95	1	54.95	
	Lap. bawah	0.019	2	7.61	0.19	0	2.23	15.60	34.79	1	34.79	
	Susut	0.019	4	7.61	0	0	2.23	30.44	67.88	1	67.88	
		0.019	4	5.40	0	0	2.23	21.60	48.17	1	48.17	
		0.012	2	10.80	0	0.48	0.89	22.56	20.08	1	20.08	
JUMLAH									289.42		289.42	
I.6 As 2-4(As D,E), As 5-7(As B,F), As 8-10(As B,F), As 11-13(As D,E), As C-D(As 4,11) (As ke As = 7.20 m)												
S1	Pokok	0.019	4	7.20	0	0.76	2.23	31.84	71.00	10	710.03	
		0.019	4	7.20	0	0.76	2.23	31.84	71.00	10	710.03	
	Susut	0.012	2	7.20	0	0.48	0.89	15.36	13.67	10	136.70	
JUMLAH									155.68		1556.8	
I.7 As 4-5(As F), As 10-11(As F), As A-B(As 7,8) (As ke As = 3.60 m)												
S1	Pokok	0.019	4	5.00	0	0.76	2.23	23.04	51.38	4	205.52	
		0.019	3	5.00	0	0.76	2.23	17.28	38.53	4	154.14	
	Susut	0.012	2	4.50	0	0.48	0.89	9.96	8.86	4	35.46	
JUMLAH									98.78		395.1	
II.1 As 12-14(As G,J), As G-J(AS 12,14) (As ke As = 7.20 m)												
S2	Pokok	0.019	4	10.13	0	0	2.23	40.52	90.36	4	361.44	
		0.019	4	10.13	0	0	2.23	40.52	90.36	4	361.44	
	Susut	0.012	2	9.33	0	0	0.89	18.66	16.61	4	66.43	
JUMLAH									197.33		789.3	
II.2 As 1-3(As G,J), As G-J(As 1,3) (As ke As = 7.20 m)												
S2	Pokok	0.019	4	10.60	0	0	2.23	42.40	94.55	4	378.21	
		0.019	4	10.60	0	0	2.23	42.40	94.55	4	378.21	
	Susut	0.012	2	9.80	0	0	0.89	19.60	17.44	4	69.78	
JUMLAH									206.55		826.2	
III.1 As 7-8 (As L) (As ke As = 10.80 m)												
S2'	Pokok	0.019	3	10.80	0	0.76	2.23	34.68	77.34	1	77.34	
		0.019	3	10.80	0	0.76	2.23	34.68	77.34	1	77.34	
	Susut	0.012	2	10.80	0	0.48	0.89	22.56	20.08	1	20.08	
JUMLAH									174.75		174.8	
III.2 As F-K (As 5,10) (As ke As = 10.80 m)												
S2'	Pokok	0.019	3	11.80	0	0	2.23	35.40	78.94	2	157.88	
		0.019	3	11.80	0	0	2.23	35.40	78.94	2	157.88	
	Susut	0.012	2	11.20	0	0	0.89	22.40	19.94	2	39.87	
JUMLAH									177.82		355.6	

II.3 As 11-12(As H,D, As 3-4(As H,D) (As ke As = 5,27 m.)										
S2' Pokok	0.019	3	6.42	0	0.76	2.23	21.54	48.03	4	192.14
	0.019	3	6.42	0	0.76	2.23	21.54	48.03	4	192.14
Susut	0.012	2	6.02	0	0.48	0.89	13.00	11.57	4	40.28
							JUMLAH	107.64		430.6
II.4 As B-C(As 5,10), As 4-5(As C), As 10-11(As C) (As ke As = 3,60 m.)										
S2' Pokok	0.019	3	6.37	0	0	2.23	19.10	42.58	4	170.33
	0.019	3	6.37	0	0	2.23	19.10	42.58	4	170.33
Susut	0.012	2	5.57	0	0	0.89	11.13	9.91	4	39.62
							JUMLAH	95.07		380.3
II.5 As 4-5(As H,D), As 10-11(As H,D) (As ke As = 3,60 m.)										
S2' Pokok	0.019	3	4.90	0	0.76	2.23	16.98	37.87	4	151.46
	0.019	3	4.90	0	0.76	2.23	16.98	37.87	4	151.46
Susut	0.012	2	4.50	0	0.48	0.89	9.96	8.86	4	35.46
							JUMLAH	84.60		338.4
III. As D-E(As 2,13), As 7-8(As A) (As ke As = 10,80 m.)										
S3 Tump. atas	0.019	3	4.39	0	0	2.23	13.17	29.37	3	88.11
Tump. bawah	0.019	1	6.61	0.19	0	2.23	6.80	15.16	3	45.49
	0.019	3	6.61	0	0	2.23	19.83	44.22	3	132.66
Lap. atas	0.019	1	7.61	0.19	0	2.23	7.80	17.39	3	52.18
	0.019	3	7.61	0	0	2.23	22.83	50.91	3	152.73
Lap. bawah	0.019	3	5.39	0	0	2.23	16.17	36.06	3	108.18
Susut	0.012	2	11.00	0	0	0.89	22.00	19.58	3	58.74
							JUMLAH	212.70		638.09
IV.1 As 5-6(As K), As 6-7(As K,L), As 8-9(As K,L), As 9-10(As K) (As ke As = 3,60 m.)										
S4 Pokok	0.019	2	4.90	0	0.76	2.23	11.32	25.24	6	151.46
	0.019	2	4.90	0	0.76	2.23	11.32	25.24	6	151.46
							JUMLAH	50.49		302.92
IV.2 As K-L (As 6,9) (As ke As = 3,60 m.)										
S4 Pokok	0.019	2	5.40	0	0	2.23	10.80	24.08	2	48.17
	0.019	2	5.40	0	0	2.23	10.80	24.08	2	48.17
							JUMLAH	48.17		96.34

Perhitungan Kebutuhan Besi Tulangan Begel Balok Sloof

Type	Lebar Balok (m)	Tinggi Balok (m)	Panjang Balok (m)	φ Besi	Keliling Balok (m)	Selimut Beton 4cm (m)	Kait 10 D (m)	Jarak antar Begel (m)	Berat Besi (kg/m)	Panjang 1 bh Begel (m)	Jumlah Begel	Berat Begel (kg)	Jumlah Tipe Sloof	Berat Total Begel (kg)
a	b	c	d	e	$f = (2*b) + (2*c)$	$g = 4*0.04$	$h = 2*10^*e$	i	j	$k = f-g+h$	$l = (d/i) + 1$	$m = j*k*1$	n	$o = m*n$
S1	0.4	0.6	10.15	0.008	2.0	0.16	0.16	0.15	0.37	2.00	69	51.06	21	1072.26
S1	0.4	0.6	6.55	0.008	2.0	0.16	0.16	0.15	0.37	2.00	45	33.05	10	330.53
S1	0.4	0.6	2.95	0.008	2.0	0.16	0.16	0.20	0.37	2.00	16	11.66	4	46.62
S2	0.3	0.5	6.55	0.008	1.6	0.16	0.16	0.15	0.37	1.60	45	26.44	8	211.54
S2"	0.3	0.5	8.85	0.008	1.6	0.16	0.16	0.20	0.37	1.60	45	26.79	3	80.36
S2"	0.3	0.5	4.72	0.008	1.6	0.16	0.16	0.20	0.37	1.60	25	14.56	4	58.25
S2"	0.3	0.5	2.95	0.008	1.6	0.16	0.16	0.20	0.37	1.60	16	9.32	8	74.59
S3	0.3	0.5	10.15	0.008	1.6	0.16	0.16	0.15	0.37	1.60	69	40.65	3	121.95
S4	0.3	0.4	3.05	0.008	1.4	0.16	0.16	0.20	0.37	1.40	16	8.42	8	67.34

Rekapitulasi Kebutuhan Besi Tulangan Ulir Balok Sloof

No	Tipe	Jenis	Ø Besi Ulir	Berat Tulangan (kg)	Total Berat Tul. (kg)	Volume Beton (m ³)	Konversi Tul. dlm 1m ³ Beton (kg)	Besi (koef bhnxbrt tul) (kg)	Bendrat (koef bhnxbrt tul) (kg)
a	b	c	d	e	$f = \sum e$	g	$h = (1/g) * f$	$i = 1.10 * h$	$j = 0.02 * h$
I.1	S1	Tump. atas Tump. bawah Lap. atas Lap. bawah	D 19 D 19 D 19 D 19 D 19	36.13 28.32 54.95 34.34 66.99 48.17	268.90	1.97	136.50	150.15	2.73
I.2	S1	Tump. atas Tump. bawah Lap. atas Lap. bawah	D 19 D 19 D 19 D 19 D 19	48.17 34.57 67.44 34.57 67.44 48.17	300.36	2.06	145.81	160.39	2.92
I.3	S1	Tump. atas Tump. bawah Lap. atas Lap. bawah	D 19 D 19 D 19 D 19 D 19	36.13 28.32 54.95 34.34 66.99 48.17	268.90	1.87	143.80	158.18	2.88
I.4	S1	Tump. atas Tump. bawah Lap. atas Lap. bawah	D 19 D 19 D 19 D 19 D 19	37.02 28.32 54.95 33.90 66.10 48.17	268.46	1.78	150.82	165.90	3.02
I.5	S1	Tump. atas Tump. bawah Lap. atas Lap. bawah	D 19 D 19 D 19 D 19 D 19	35.23 28.32 54.95 34.79 67.88 48.17	269.34	2.16	124.69	137.16	2.49
I.6	S1	Pokok	D 19 D 19	71.00 71.00	142.00	1.20	118.33	130.17	2.37
I.7	S1	Pokok	D 19 D 19	51.38 38.53	89.91	0.43	209.09	230.00	4.18
II.1	S2	Pokok	D 19 D 19	90.36 90.36	180.72	0.76	237.79	261.57	4.76
II.2	S2	Pokok	D 19 D 19	94.55 94.55	189.10	0.69	274.06	301.46	5.48
II.1	S2'	Pokok	D 19 D 19	77.34 77.34	154.68	1.35	114.58	126.04	2.29
II.2	S2'	Pokok	D 19 D 19	78.94 78.94	157.88	1.11	142.23	156.46	2.84

II.3	S2'	Pokok	D 19 D 19	48.03 48.03	96.06	0.49	196.04	215.64	3.92
II.4	S2'	Pokok	D 19 D 19	42.58 42.58	85.16	0.25	340.64	374.70	6.81
II.5	S2'	Pokok	D 19 D 19	37.87 37.87	75.74	0.29	261.17	287.29	5.22
III	S3	Tump. atas Tump. bawah Lap. atas Lap. bawah	D 19 D 19 D 19 D 19 D 19	29.37 15.16 44.22 17.39 50.91 36.06	193.11	1.35	143.04	157.35	2.86
IV.1	S4	Pokok	D 19 D 19	25.24 25.24	50.48	0.22	229.45	252.40	4.59
IV.2	S4	Pokok	D 19 D 19	24.08 24.08	48.16	0.31	155.35	170.89	3.11

Rekapitulasi Kebutuhan Besi Tulangan Polos Balok Sloof

No	Tipe	Jenis	ϕ Besi Polos	Berat Tulangan (kg)	Total Berat Tul. (kg)	Volume Beton (m ³)	Konversi Tul. dlm 1m ³ Beton (kg)	Besi (koef bhxbrt tul) (kg)	Bendrat (koef bhxbrt tul) (kg)
a	b	c	d	e	f = ∑ e	g	h = (1/g) * f	i = 1.10 * h	j = 0.02 * h
I.1	S1	Susut Begel	P 12 P8-150	20.08 51.06	71.14	1.97	36.11	39.72	0.72
I.2	S1	Susut Begel	P 12 P8-150	20.08 51.06	71.14	2.06	34.53	37.99	0.69
I.3	S1	Susut Begel	P 12 P8-150	20.08 51.06	71.14	1.87	38.04	41.85	0.76
I.4	S1	Susut Begel	P 12 P8-150	20.08 51.06	71.14	1.78	39.97	43.96	0.80
I.5	S1	Susut Begel	P 12 P8-150	20.08 51.06	71.14	2.16	32.94	36.23	0.66
I.6	S1	Susut Begel	P 12 P8-150	13.67 33.05	46.72	1.20	38.93	42.83	0.78
I.7	S1	Susut Begel	P 12 P8-200	8.86 11.66	20.52	0.43	47.72	52.49	0.95
II.1	S2	Susut Begel	P 12 P8-150	16.61 26.44	43.05	0.76	56.64	62.31	1.13
II.2	S2	Susut Begel	P 12 P8-150	17.44 26.44	43.88	0.69	63.59	69.95	1.27
II.1	S2'	Susut Begel	P 12 P8-200	20.08 26.79	46.87	1.35	34.72	38.19	0.69
II.2	S2'	Susut Begel	P 12 P8-200	19.94 26.79	46.73	1.11	42.10	46.31	0.84
II.3	S2'	Susut Begel	P 12 P8-200	11.57 14.56	26.13	0.49	53.33	58.66	1.07
II.4	S2'	Susut Begel	P 12 P8-200	9.91 9.32	19.23	0.25	76.92	84.61	1.54
II.5	S2'	Susut Begel	P 12 P8-200	8.86 9.52	18.18	0.29	62.69	68.96	1.25
III.	S3	Susut Begel	P 12 P8-150	19.58 40.65	60.23	1.35	44.61	49.08	0.89
IV.1	S4	Begel	P8-200	8.42	8.42	0.22	38.27	42.10	0.77
IV.2	S4	Begel	P8-200	8.42	8.42	0.31	27.16	29.88	0.54

**DAFTAR ANALISA HARGA SATUAN
PEKERJAAN BALOK SLOOF**

No	Uraian	Volume	Sat.	Harga Satuan (Rp)	Analisa Harga Bahan (Rp)	Analisa Harga Upah (Rp)	Total Harga Analisa (Rp)
V	PEKERJAAN BETON SLOOF						
1.1	SLOOF TIPE - S1 (40/60)						
	BAHAN						
	Paku	1.00	kg	6,000.00	5,993.40		
	Besi ulir	150.15	kg	3,350.00	503,002.50		
	Besi polos	39.72	kg	3,000.00	119,160.00		
	Multiplek 15 mm (50%)	1.91	lbr	60,000.00	57,240.00		
	Beton Ready Mix <i>fc' 25 Mpa</i>	1.00	m ³	274,000.00	274,000.00		
	Kayu Bekisting (50%)	0.07	m ³	1,700,000.00	59,075.00		
	Bendrat	3.45	kg	6,500.00	22,425.00		
	Minyak bekisting	1.00	ltr	12,500.00	12,486.25		1,053,382.15
	UPAH BORONGAN						
	Cor ready mix	1.00	m ³	32,500.00		32,500.00	
	Buat + stel besi	189.87	kg	200.00		37,974.00	
	Bekisting	4.99	m ²	9,000.00		44,910.00	115,384.00
					Jumlah		1,168,766.15
					Dibulatkan		1,168,766.00
1.2	SLOOF - S1 (40/60)						
	BAHAN						
	Paku	1.00	kg	6,000.00	5,993.40		
	Besi ulir	160.39	kg	3,350.00	537,306.50		
	Besi polos	37.99	kg	3,000.00	113,970.00		
	Multiplek 15 mm (50%)	1.91	lbr	60,000.00	57,240.00		
	Beton Ready Mix <i>fc' 25 Mpa</i>	1.00	m ³	274,000.00	274,000.00		
	Kayu Bekisting (50%)	0.07	m ³	1,700,000.00	59,075.00		
	Bendrat	3.61	kg	6,500.00	23,465.00		
	Minyak bekisting	1.00	ltr	12,500.00	12,486.25		1,083,536.15
	UPAH BORONGAN						
	Cor ready mix	1.00	m ³	32,500.00		32,500.00	
	Buat + stel besi	198.38	kg	200.00		39,676.00	
	Bekisting	4.99	m ²	9,000.00		44,910.00	117,086.00
					Jumlah		1,200,622.15
					Dibulatkan		1,200,622.00
1.3	SLOOF - S1 (40/60)						
	BAHAN						
	Paku	1.00	kg	6,000.00	5,993.40		
	Besi ulir	158.18	kg	3,350.00	529,903.00		
	Besi polos	41.85	kg	3,000.00	125,550.00		
	Multiplek 15 mm (50%)	1.91	lbr	60,000.00	57,240.00		
	Beton Ready Mix <i>fc' 25 Mpa</i>	1.00	m ³	274,000.00	274,000.00		
	Kayu Bekisting (50%)	0.07	m ³	1,700,000.00	59,075.00		
	Bendrat	3.64	kg	6,500.00	23,660.00		
	Minyak bekisting	1.00	ltr	12,500.00	12,486.25		1,087,907.65
	UPAH BORONGAN						
	Cor ready mix	1.00	m ³	32,500.00		32,500.00	
	Buat + stel besi	200.03	kg	200.00		40,006.00	
	Bekisting	4.99	m ²	9,000.00		44,910.00	117,416.00
					Jumlah		1,205,323.65
					Dibulatkan		1,205,324.00

IV.1	SLOOF - S4 (30/40)							
	BAHAN							
	Paku	1.31	kg	6,000.00	7,860.00			
	Besi ulir	252.40	kg	3,350.00	845,540.00			
	Besi polos	42.10	kg	3,000.00	126,300.00			
	Multiplek 15 mm (50%)	2.50	lbr	60,000.00	75,063.00			
	Beton Ready Mix K-250	1.00	m ³	274,000.00	274,000.00			
	Kayu Bekisting (50%)	0.09	m ³	1,700,000.00	77,350.00			
	Bendrat	5.36	kg	6,500.00	34,840.00			
	Minyak bekisting	1.31	ltr	12,500.00	16,375.00			1,457,328.00
	UPAH BORONGAN							
	Cor ready mix	1.00	m ³	32,500.00		32,500.00		
	Buat + stel besi	294.50	kg	200.00		58,900.00		
	Bekisting	6.55	m ²	9,000.00		58,950.00		150,350.00
					Jumlah			1,607,678.00
					Dibulatkan			1,607,678.00
IV.2	SLOOF - S4 (30/40)							
	BAHAN							
	Paku	1.31	kg	6,000.00	7,860.00			
	Besi ulir	170.89	kg	3,350.00	572,481.50			
	Besi polos	29.88	kg	3,000.00	89,640.00			
	Multiplek 15 mm (50%)	2.50	lbr	60,000.00	75,063.00			
	Beton Ready Mix K-250	1.00	m ³	274,000.00	274,000.00			
	Kayu Bekisting (50%)	0.09	m ³	1,700,000.00	77,350.00			
	Bendrat	3.65	kg	6,500.00	23,725.00			
	Minyak bekisting	1.31	ltr	12,500.00	16,375.00			
	UPAH BORONGAN							
	Cor ready mix	1.00	m ³	32,500.00		32,500.00		
	Buat + stel besi	200.77	kg	200.00		40,154.00		
	Bekisting	6.55	m ²	9,000.00		58,950.00		1,136,494.50
					Jumlah			1,268,098.50
					Dibulatkan			1,268,099.00

**ANALISA HARGA
PEKERJAAN BALOK SLOOF**

No	Uraian Pekerjaan	Volume	Sat.	Harga Satuan (Rp)	Harga Tiap Pekerjaan (Rp)	Harga Total Tiap Pekerjaan (Rp)
V	PEKERJAAN BALOK SLOOF					
1	Beton sloof tipe S1 (40/60)	25.58	m ³	1,168,766.15	29,897,038.12	
2	Beton sloof tipe S1 (40/60)	8.26	m ³	1,200,622.15	9,917,138.96	
3	Beton sloof tipe S1 (40/60)	3.74	m ³	1,205,323.65	4,507,910.45	
4	Beton sloof tipe S1 (40/60)	1.78	m ³	1,240,651.65	2,208,359.94	
5	Beton sloof tipe S1 (40/60)	2.16	m ³	1,109,533.65	2,396,592.68	
6	Beton sloof tipe S1 (40/60)	12.00	m ³	1,105,839.15	13,270,069.80	
7	Beton sloof tipe S1 (40/60)	1.73	m ³	1,504,017.65	2,601,950.53	
8	Beton sloof tipe S2 (30/50)	3.04	m ³	1,712,691.50	5,206,582.16	
9	Beton sloof tipe S2 (30/50)	2.76	m ³	1,884,339.00	5,200,775.64	
10	Beton sloof tipe S2' (30/50)	1.35	m ³	1,135,461.00	1,532,872.35	
11	Beton sloof tipe S2' (30/50)	2.22	m ³	1,273,986.00	2,828,248.92	
12	Beton sloof tipe S2' (30/50)	1.96	m ³	1,532,110.00	3,002,935.60	
13	Beton sloof tipe S2' (30/50)	0.99	m ³	2,201,653.00	2,179,636.47	
14	Beton sloof tipe S2' (30/50)	1.17	m ³	1,829,047.50	2,139,985.58	
15	Beton sloof tipe S3 (30/50)	4.05	m ³	1,286,464.50	5,210,181.23	
16	Beton sloof tipe S4 (30/40)	1.30	m ³	1,607,678.00	2,089,981.40	
17	Beton sloof tipe S4 (30/40)	0.62	m ³	1,268,098.50	786,221.07	94,976,480.89
Harga Pekerjaan Balok Sloof						94,976,480.89

LAMPIRAN 6

Perhitungan Volume Beton dan Volume Bekisting Kolom

Volume Beton dan Bekisting Kolom Penampang Lingkaran

Level	Tipe	Dimensi Kolom (mm)	Tinggi Kolom (m)	Volume Beton (m ³)	Volume Bekisting (m ²)	Jumlah Tipe (bh)	Vol. Total Beton (m ³)	Vol. Total Bekisting (m ²)
a	b	c	d	$e = 1/4 * \pi * c^2 * d$	$f = \pi * c * d$	g	$h = c * g$	$i = f * g$
L1	K1	Ø 850	4.95	2.81	13.22	2	5.62	26.44
	K2	Ø 850	4.85	2.75	12.95	2	5.50	25.90
<i>Jumlah</i>							11.12	52.34
L2	K1	Ø 850	8.96	5.08	23.93	2	10.17	47.85
	K2	Ø 850	4.48	2.54	11.96	2	5.08	23.93
<i>Jumlah</i>							15.25	71.78
L3	K2	Ø 850	4.48	2.54	11.96	2	5.08	23.93
<i>Jumlah</i>							5.08	23.93
ATAP	K1	Ø 850	3.6	2.04	9.61	2	4.09	19.23
	K2	Ø 850	3.6	2.04	9.61	2	4.09	19.23
<i>Jumlah</i>							8.17	38.45

Volume Beton dan Bekisting Kolom Penampang Segi Empat

Level	Tipe	b Kolom (m)	h Kolom (m)	Tinggi Kolom (m)	Volume Beton (m ³)	Volume Bekisting (m ²)	Jumlah Tipe (bh)	Vol. Total Beton (m ³)
a	b	c	d	e	$f = c * d * e$	$g = (4 * c) * e$	h	$i = f * h$
L1	K3	0.75	0.75	4.95	2.78	14.85	2	5.57
	K4	0.65	0.65	4.95	2.09	12.87	6	12.55
	K5	0.65	0.65	5.20	2.20	13.52	10	21.97
	K6	0.65	0.65	5.20	2.20	13.52	2	4.39
	K7	0.65	0.65	5.20	2.20	13.52	4	8.79
	K8	0.65	0.65	5.25	2.22	13.65	4	8.87
	K9	0.65	0.65	5.25	2.22	13.65	8	17.75
	KM1	0.65	0.65	5.25	2.22	13.65	4	8.87
	KM2	0.65	0.65	5.25	2.22	13.65	2	4.44
	KM3	0.65	0.65	5.25	2.22	13.65	2	4.44
<i>Jumlah</i>								97.63
L2	K3	0.75	0.75	4.48	2.52	13.44	2	5.04
	K4	0.65	0.65	4.48	1.89	11.65	6	11.36
	K5	0.65	0.65	4.48	1.89	11.65	10	18.93
	K6	0.65	0.65	4.48	1.89	11.65	2	3.79
	K7	0.65	0.65	4.48	1.89	11.65	4	7.57
	K8	0.55	0.55	4.48	1.36	9.86	4	5.42
	K9	0.55	0.55	4.48	1.36	9.86	8	10.84
	K10	0.40	0.65	4.38	1.14	11.39	4	4.56
	KM1	0.55	0.55	4.48	1.36	9.86	4	4.56
	KM2	0.55	0.55	4.48	1.36	9.86	2	2.71
KM3	0.55	0.55	4.48	1.36	9.86	2	2.71	
<i>Jumlah</i>								77.48
L3	K3	0.75	0.75	4.48	2.52	13.44	2	5.04
	K4	0.65	0.65	4.48	1.89	11.65	6	11.36
	K5	0.65	0.65	4.48	1.89	11.65	10	18.93
	K6	0.65	0.65	4.48	1.89	11.65	2	3.79
	K7	0.65	0.65	4.48	1.89	11.65	4	7.57
	K8	0.55	0.55	4.48	1.36	9.86	4	5.42
	K9	0.55	0.55	4.48	1.36	9.86	8	10.84
	KM1	0.55	0.55	4.48	1.36	9.86	4	5.42
	KM2	0.55	0.55	4.48	1.36	9.86	2	2.71
	KM3	0.55	0.55	4.48	1.36	9.86	2	2.71
<i>Jumlah</i>								73.79

Volume Beton dan Bekisting Kolom Penampang L

Level	Tipe	b Kolom (m)	h Kolom (m)	b2 Kolom (m)	h2 Kolom (m)	Tinggi Kolom (m)	Kll (1) Kolom (m)	Kll (2) Kolom (m)	Volume Beton (m ³)	Volume Bekisting (m ²)	Jumlah Tipe (bh)	Vol. Total Beton (m ³)	Vol. Total Bekisting (m ²)
a	b	c	d	e	f	g	h	I	$j=((c*d)+(e*f))*g$	$k=(h+I)*g$	l	$m=j*l$	$n=k*l$
L1	KL1	0.4	0.65	0.25	0.4	5.20	1.7	1.3	1.87	15.60	6	11.23	93.60
	KL2	0.4	0.65	0.25	0.4	5.05	1.7	1.3	1.82	15.15	4	7.27	60.60
<i>Jumlah</i>												18.50	154.20
L2	KL1	0.4	0.65	0.25	0.4	4.48	1.7	1.3	1.61	13.44	6	9.68	80.6
	KL2	0.4	0.75	0.35	0.4	4.48	1.9	1.5	1.97	15.23	4	7.88	60.92
<i>Jumlah</i>												17.56	141.57
L3	KL1	0.4	0.65	0.25	0.4	4.93	1.7	1.3	1.77	14.79	6	10.65	88.74
	KL2	0.4	0.75	0.35	0.4	4.93	1.9	1.5	2.17	16.76	4	8.68	67.05
<i>Jumlah</i>												19.33	155.79

Perhitungan Kebutuhan Besi Tulangan Pokok Kolom

Level	Tipe	Dimensi Kolom (mm)	Tinggi Kolom (m)	ØBesi (mm)	Tinggi Poer Pile (m)	Jrk elev lt 1 ke poer pl (m)	Pjg Besi Tkk (m)	Perpigan (40 D) (m)	Kait (10 D) (m)	Panjang Besi (m)	Jml Besi (bh)	Berat Besi (kg/m)	Volume Besi (kg)
a	b	c	d	e	f	g	h	i	j	$k = d+f+g+h+i+j$	l	m	$n = k \cdot l \cdot m$
L1	K1	Ø850	4.48	D25	0.90	0.47	1.15	1.00	0.25	8.25	36	3.85	1.143.45
	K2	Ø850	4.48	D25	1.00	0.37	1.15	1.00	0.25	8.25	28	3.85	889.35
	K3	750/750	4.48	D25	0.90	0.47	1.15	1.00	0.25	8.25	28	3.85	889.35
	K4	650/650	4.48	D25	0.90	0.47	1.15	1.00	0.25	8.25	32	3.85	1.016.40
	K5	650/650	4.48	D25	0.65	0.72	0.75	1.00	0.25	7.85	16	3.85	483.56
	K6	650/650	4.48	D25	0.65	0.72	0.915	1.00	0.25	8.02	20	3.85	617.16
	K7	650/650	4.48	D25	0.55	0.72	0.75	1.00	0.25	7.85	24	3.85	725.34
	K8	650/650	4.48	D25	0.60	0.77	0.75	1.00	0.25	7.85	20	3.85	604.45
	K9	650/650	4.48	D25	0.60	0.77	0.75	1.00	0.25	7.85	16	3.85	483.56
	KM1	650/650	4.48	D25	0.60	0.77	0.695	1.00	0.25	7.80	12	3.85	360.13
	KM2	650/650	4.48	D25	0.60	0.77	0.695	1.00	0.25	7.80	20	3.85	600.22
	KM3	650/650	4.48	D25	0.60	0.77	0.695	1.00	0.25	7.80	28	3.85	840.30
	KL1	L400/600	4.48	D25	0.65	0.72	0.915	1.00	0.25	8.02	24	3.85	740.59
	KL2	L400/600	4.48	D25	0.80	0.57	1.045	1.00	0.25	8.15	36	3.85	1.128.90

Level	Tipe	Pot	Dimensi Kolom (mm)	Tinggi Kolom (m)	Ø Besi (mm)	Panjang Besi Pot (m)	Pjg Besi (m)	Perpigan (40 D) (m)	Jumlah Besi (bh)	Berat Besi (kg/m)	Volume Besi (kg)	Volume Besi Total (kg)
a	b	c	d	e	f	g	$h = \sum g$	I	j	k	$m = (h * j * k) + 1$	$n = \sum m$
L2	K1	A	Ø850	8.96	D25	4.48	4.48	1.0	36	3.85	759.53	1.350.27
		B	Ø850	8.96	D25	4.48	4.48	1.0	28	3.85	590.74	
	K2	A	Ø850	4.48	D25	4.37	4.37	1.0	28	3.85	578.89	681.45
		B	Ø850	4.48	D25	0.11	0.11	1.0	24	3.85	102.56	
	K3	BC	750/750	4.48	D25	3.38	3.38	1.0	28	3.85	472.16	667.13
		D	750/75	4.48	D25	1.11	1.11	1.0	24	3.85	194.96	
	K4	BC	650/650	4.48	D25	3.37	3.37	1.0	32	3.85	538.38	765.84
		D	650/650	4.48	D25	1.11	1.11	1.0	28	3.85	227.46	
	K5	BC	650/650	4.48	D25	3.37	3.37	1.0	16	3.85	269.19	366.67
		D	650/650	4.48	D25	1.11	1.11	1.0	12	3.85	97.48	
	K6	BC	650/650	4.48	D25	3.37	3.37	1.0	20	3.85	336.49	466.47
		D	650/650	4.48	D25	1.11	1.11	1.0	16	3.85	129.98	
	K7	BC	650/650	4.48	D25	3.37	3.37	1.0	24	3.85	403.79	566.26
		D	650/650	4.48	D25	1.11	1.11	1.0	20	3.85	162.47	
	K8	BC	550/550	4.48	D25	3.37	3.37	1.0	24	3.85	403.79	566.26
		D	550/550	4.48	D25	1.11	1.11	1.0	20	3.85	162.47	
	K9	BC	550/550	4.48	D25	3.33	3.37	1.0	16	3.85	269.19	366.67
		D	550/550	4.48	D25	1.11	1.11	1.0	12	3.85	97.48	
	KM1	BC	550/550	4.48	D25	3.37	3.37	1.0	12	3.85	201.89	299.38
		D	550/550	4.48	D25	1.11	1.11	1.0	12	3.85	97.48	
	KM2	BC	550/550	4.48	D25	3.37	3.37	1.0	20	3.85	336.49	482.71
		D	550/550	4.48	D25	1.11	1.11	1.0	18	3.85	146.22	
	KM3	BC	550/550	4.48	D25	3.37	3.37	1.0	28	3.85	471.09	666.05
		D	550/550	4.48	D25	1.11	1.11	1.0	24	3.85	194.96	
	KL1	BC	1.400/650	4.48	D25	3.37	3.37	1.0	24	3.85	403.79	566.26
		D	1.400/650	4.48	D25	1.11	1.11	1.0	20	3.85	162.47	
	KL2	BC	1.400/750	4.48	D25	3.37	3.37	1.0	36	3.85	605.68	898.13
		D	1.400/750	4.48	D25	1.11	1.11	1.0	36	3.85	292.45	

Level	Tipe/ Pot	Dimensi Kolom (mm)	Tinggi Kolom (m)	ØBesi (mm)	Panjang Besi Pot (m)	Panjang Besi Tkk (m)	Kait Bawah (10 D) (m)	Kait Atas (5 D) (m)	Panjang Besi (m)	Jml Besi (bh)	Brt Besi (kg/m)	Volume Besi (kg)
a	b	d	e	f	g	h	i	j	$k=g+h+I-j$	h	I	$j-g*h*I$
I.2	K10 A	400/650	4.38	D25	4.68	0.5	0.25	0.125	5.56	20	3.85	427.74

Level	Tipe	Dimensi Kolom (mm)	Tinggi Kolom (m)	ØBesi (mm)	Panjang Besi (m)	Jumlah Besi (bh)	Berat Besi (kg/m)	Volume Besi (kg)
a	b	c	d	e	f	g	h	$I=f*g*h$
I.3	K2	Ø850	4.48	D25	4.48	24	3.85	413.95
	K3	750/750	4.48	D25	4.81	24	3.85	444.44
	K4	650/650	4.48	D25	4.93	28	3.85	531.45
	K5	650/650	4.48	D25	4.93	12	3.85	227.77
	K6	650/650	4.48	D25	4.93	16	3.85	303.69
	K7	650/650	4.48	D25	4.93	16	3.85	303.69
	K8	550/550	4.48	D25	4.81	20	3.85	370.37
	K9	550/550	4.48	D25	4.81	12	3.85	222.22
	KM1	550/550	4.48	D25	4.73	12	3.85	218.53
	KM2	550/550	4.48	D25	4.73	18	3.85	327.79
	KM3	550/550	4.48	D25	4.73	24	3.85	437.05
	KL1	L400/650	4.48	D25	4.93	20	3.85	379.61
KL2	L400/650	4.48	D25	4.93	36	3.85	683.30	
Atap	K1	Ø850	3.6	D25	3.6	24	3.85	332.64
	K2	Ø850	3.6	D25	3.6	24	3.85	332.64

Perhitungan Kebutuhan Besi Tulangan Begel Kolom

Begel kolom berpenampang lingkaran

Level	Type	Diameter Kolom (m)	L Kolom (m)	Ø Besi (mm)	Selimit Kolom (m)	Kll Kolom (m)	Kll Selimit (m)	d' (m)	L' (m)	Perpigan (40 D) (m)	Jrk Bgl (m)	Panjang Begel (m)	Berat Besi (kg/m)	Vol Begel (kg)	Vol Begel Kolom (kg)
a	b	c	d	e	f	$g = \pi * c$	$h = \pi * f$	$i = g - h$	$j = d - 0,45$	k	l	$m = \frac{j}{l} \sqrt{(3,14 * i)^2 + l^2}$	n	$o = m * n$	$p = \sum m$
L1	K1	0.85	5.23	P12	0.03	2.67	0.09	2.58	4.78	1	0.1	387.65	0.89	345.01	345.01
	K2	0.85	5.23	P12	0.03	2.67	0.09	2.58	4.78	1	0.1	387.65	0.89	345.01	345.01
L2	K1	0.85	8.96	P12	0.03	2.67	0.09	2.58	8.51	1	0.1	689.37	0.89	613.54	1,227.08
	Pot A	0.85	8.96	P12	0.03	2.67	0.09	2.58	8.51	1	0.1	689.37	0.89	613.54	
	K2	0.85	4.48	P12	0.03	2.67	0.09	2.58	4.03	1	0.1	326.99	0.89	291.02	
	Pot B	0.85	4.48	P12	0.03	2.67	0.09	2.58	4.03	1	0.1	326.99	0.89	291.02	
L3	K2	0.85	4.48	P12	0.03	2.67	0.09	2.58	4.03	1	0.1	326.99	0.89	291.02	582.03
ATAP	K1	0.85	3.6	P12	0.03	2.67	0.09	2.58	3.15	1	0.1	255.80	0.89	227.66	227.66
	K2	0.85	3.6	P12	0.03	2.67	0.09	2.58	3.15	1	0.1	255.80	0.89	227.66	227.66

Level	Type	b (m)	h (m)	Selimum Kolom (m)	b' Bersih (m)	h' Bersih (m)	Jrk Pot (m)	Ø Besi (mm)	Kait (2 x 100) (m)	Panjang Begel (m)	Jrk Bgt (m)	Jumlah Begel (bh)	Banyak Begel (bh)	Berat Besi (kg/m)	Volume Begel (kg)	Vol Bgl Kolom (kg)		
a	b	c	d	e	f=c-e	g=d-e	h	i	j	k=(4*j)+i	l	m = h/l	n=m+1	o	p=k*n*o	q=∑p		
L1	K3 Pot A Pot B Pot C	0.75	0.75	0.03	0.69	0.69	1.20	P10	0.2	2.96	0.08	15	16	0.62	29.31	85.05		
		0.75	0.75	0.03	0.69	0.69	2.39	P10	0.2	2.96	0.15	16	17	0.62	31.01			
		0.75	0.75	0.03	0.69	0.69	1.25	P10	0.2	2.96	0.1	12	13	0.62	24.73			
	K4 Pot A Pot B Pot C	0.65	0.65	0.03	0.59	0.59	1.20	P10	0.2	2.56	0.08	15	16	0.62	25.35		73.29	
		0.65	0.65	0.03	0.59	0.59	2.44	P10	0.2	2.56	0.15	16	17	0.62	27.35			
		0.65	0.65	0.03	0.59	0.59	1.20	P10	0.2	2.56	0.1	12	13	0.62	20.59			
	K5 Pot A Pot B Pot C	0.65	0.65	0.03	0.59	0.59	1.20	P10	0.2	2.56	0.08	15	16	0.62	25.35			73.29
		0.65	0.65	0.03	0.59	0.59	2.44	P10	0.2	2.56	0.15	16	17	0.62	27.35			
		0.65	0.65	0.03	0.59	0.59	1.20	P10	0.2	2.56	0.1	12	13	0.62	20.59			
K6 Pot A Pot B Pot C	0.65	0.65	0.03	0.59	0.59	1.20	P10	0.2	2.56	0.08	15	16	0.62	25.35	73.29			
	0.65	0.65	0.03	0.59	0.59	2.44	P10	0.2	2.56	0.15	16	17	0.62	27.35				
	0.65	0.65	0.03	0.59	0.59	1.20	P10	0.2	2.56	0.1	12	13	0.62	20.59				
K7 Pot A Pot B Pot C	0.65	0.65	0.03	0.59	0.59	1.20	P10	0.2	2.56	0.08	15	16	0.62	25.35		73.29		
	0.65	0.65	0.03	0.59	0.59	2.44	P10	0.2	2.56	0.15	16	17	0.62	27.35				
	0.65	0.65	0.03	0.59	0.59	1.20	P10	0.2	2.56	0.1	12	13	0.62	20.59				
K8 Pot A Pot B Pot C	0.65	0.65	0.03	0.59	0.59	1.20	P10	0.2	2.56	0.08	15	16	0.62	25.35			73.29	
	0.65	0.65	0.03	0.59	0.59	2.44	P10	0.2	2.56	0.15	16	17	0.62	27.35				
	0.65	0.65	0.03	0.59	0.59	1.20	P10	0.2	2.56	0.1	12	13	0.62	20.59				

L3	K3	0.75	0.75	0.03	0.69	0.69	1.11	P10	0.2	2.96	0.1	11	12	0.62	22.21	80.08
	Pot D	0.75	0.69	0.03	0.69	0.69	2.24	P10	0.2	2.96	0.15	15	16	0.62	29.24	
	Pot E	0.75	0.69	0.03	0.69	0.69	1.46	P10	0.2	2.96	0.1	15	16	0.62	28.63	
	Pot F	0.75	0.69	0.03	0.69	0.69										
	K4	0.65	0.59	0.03	0.59	0.59	1.11	P10	0.2	2.56	0.1	11	12	0.62	19.21	70.52
	Pot D	0.65	0.59	0.03	0.59	0.59	2.36	P10	0.2	2.56	0.15	16	17	0.62	26.56	
	Pot E	0.65	0.59	0.03	0.59	0.59	1.46	P10	0.2	2.56	0.1	15	16	0.62	24.76	
	Pot F	0.65	0.59	0.03	0.59	0.59										
	K5	0.65	0.59	0.03	0.59	0.59	1.11	P10	0.2	2.56	0.1	11	12	0.62	19.21	70.52
	Pot D	0.65	0.59	0.03	0.59	0.59	2.36	P10	0.2	2.56	0.15	16	17	0.62	26.56	
	Pot E	0.65	0.59	0.03	0.59	0.59	1.46	P10	0.2	2.56	0.1	15	16	0.62	24.76	
	Pot F	0.65	0.59	0.03	0.59	0.59										
	K6	0.65	0.59	0.03	0.59	0.59	1.11	P10	0.2	2.56	0.1	11	12	0.62	19.21	70.52
	Pot D	0.65	0.59	0.03	0.59	0.59	2.36	P10	0.2	2.56	0.15	16	17	0.62	26.56	
	Pot E	0.65	0.59	0.03	0.59	0.59	1.46	P10	0.2	2.56	0.1	15	16	0.62	24.76	
	Pot F	0.65	0.59	0.03	0.59	0.59										
	K7	0.65	0.59	0.03	0.59	0.59	1.11	P10	0.2	2.56	0.1	11	12	0.62	19.21	70.52
	Pot D	0.65	0.59	0.03	0.59	0.59	2.36	P10	0.2	2.56	0.15	16	17	0.62	26.56	
	Pot E	0.65	0.59	0.03	0.59	0.59	1.46	P10	0.2	2.56	0.1	15	16	0.62	24.76	
	Pot F	0.65	0.59	0.03	0.59	0.59										
	K8	0.55	0.49	0.03	0.49	0.49	1.11	P10	0.2	2.16	0.1	11	12	0.62	16.20	58.43
	Pot D	0.55	0.49	0.03	0.49	0.49	2.24	P10	0.2	2.16	0.15	15	16	0.62	21.34	
	Pot E	0.55	0.49	0.03	0.49	0.49	1.46	P10	0.2	2.16	0.1	15	16	0.62	20.89	
	Pot F	0.55	0.49	0.03	0.49	0.49										
	K9	0.55	0.49	0.03	0.49	0.49	1.11	P10	0.2	2.16	0.1	11	12	0.62	16.20	58.43
	Pot D	0.55	0.49	0.03	0.49	0.49	2.24	P10	0.2	2.16	0.15	15	16	0.62	21.34	
	Pot E	0.55	0.49	0.03	0.49	0.49	1.46	P10	0.2	2.16	0.1	15	16	0.62	20.89	
	Pot F	0.55	0.49	0.03	0.49	0.49										
	K9	0.55	0.49	0.03	0.49	0.49	1.46	P10	0.2	2.16	0.1	15	16	0.62	20.89	58.43

Perhitungan Kebutuhan Besi Begel Susut Vertikal Kolom

Level	Tipe	b Kolom (m)	h Kolom (m)	h' Kolom (m)	b' Bersusut (m)	h' Bersih (m)	Lebar Begel (m)	Tinggi Begel (m)	Ø Besi (mm)	Kait (2 x 100°) (m)	Panjang Begel (m)	Jrk Pot (m)	Jrk Bgl (m)	Banyak Begel (bh)	Berat Besi (kg/m)	Volume Begel (kg)	Jml Volume (kg)	
a	b	c	d	e	f=c-(2*e)	g=d-(2*e)	h=1/3*f	i	j	k	l=(2*i)+ (2*h)+k	m	n	p=o+1	q	r=l*p*q	s = Σr	
L1	K3																	
	Pot A	0.75	0.75	0.03	0.69	0.69	0.23	0.69	P10	0.2	2.04	1.20	0.08	16	0.62	20.20	37.24	
	Pot C	0.75	0.75	0.03	0.69	0.69	0.23	0.69	P10	0.2	2.04	1.25	0.1	13	0.62	17.04		
	K4																	
	Pot A	0.65	0.65	0.03	0.59	0.59	0.20	0.69	P10	0.2	1.97	1.20	0.08	16	0.62	19.54		
	Pot B	0.65	0.65	0.03	0.59	0.59	0.20	0.69	P10	0.2	1.97	2.44	0.15	17	0.62	21.08		
Pot C	0.65	0.65	0.03	0.59	0.59	0.20	0.69	P10	0.2	1.97	1.20	0.1	13	0.62	15.87			
L2	K3																	
	Pot C	0.75	0.75	0.03	0.69	0.69	0.23	0.69	P10	0.2	2.04	1.16	0.1	13	0.62	15.94	31.24	
	Pot D	0.75	0.75	0.03	0.69	0.69	0.23	0.69	P10	0.2	2.04	1.11	0.1	12	0.62	15.30		
	K4																	
	Pot C	0.65	0.65	0.03	0.59	0.59	0.20	0.69	P10	0.2	1.11	1.20	0.1	13	0.62	8.93		
	Pot B	0.65	0.65	0.03	0.59	0.59	0.20	0.69	P10	0.2	2.26	2.44	0.15	17	0.62	24.15		
Pot D	0.65	0.65	0.03	0.59	0.59	0.20	0.69	P10	0.2	1.11	1.20	0.1	13	0.62	8.93			

Perhitungan Kebutuhan Besi Begel Susut Horizontal Kolom

Level	Type	b (m)	h Kolom (m)	Selimum Kolom (m)	b' Bersih (m)	h' Bersih (m)	Lebar Begel (m)	Tinggi Begel (m)	Ø Besi (mm)	Kait (2 x 10Ø) (m)	Fa'ijang Begel (m)	Jrk Pot (m)	Jrk Bgl (m)	Jml Bgl (bh)	Banyak Begel (bh)	Berat Besi (kg/m)	Volume Begel (kg)	Jml Volume (kg)
a	b	c	d	e	f=c-(2*e)	g=d-(2*e)	h	I=1/3h'	j	k	l=(2*i)+(2*h)+k	m	n	o=m/n	p=o+1	q	r=l*p*q	s = Σr
L1	K3																	
	Pot A	0.75	0.75	0.03	0.69	0.69	0.69	0.23	P10	0.2	2.04	1.20	0.08	15	16	0.62	20.70	37.24
	Pot C	0.75	0.75	0.03	0.69	0.69	0.69	0.23	P10	0.2	2.04	1.25	0.1	12	13	0.62	17.04	
	K4																	
	Pot A	0.65	0.65	0.03	0.59	0.59	0.69	0.20	P10	0.2	1.97	1.20	0.08	15	16	0.62	19.54	56.50
	Pot B	0.65	0.65	0.03	0.59	0.59	0.69	0.20	P10	0.2	1.97	2.44	0.15	16	17	0.62	21.08	
Pot C	0.65	0.65	0.03	0.59	0.59	0.69	0.20	P10	0.2	1.97	1.20	0.1	12	13	0.62	15.87		
L2	K3																	
	Pot C	0.75	0.75	0.03	0.69	0.69	0.69	0.23	P10	0.2	2.04	1.16	0.1	12	13	0.62	15.94	31.24
	Pot D	0.75	0.75	0.03	0.69	0.69	0.69	0.23	P10	0.2	2.04	1.11	0.1	11	12	0.62	15.30	
	K4																	
	Pot C	0.65	0.65	0.03	0.59	0.59	0.69	0.20	P10	0.2	1.11	1.20	0.1	12	13	0.62	8.93	42.01
	Pot B	0.65	0.65	0.03	0.59	0.59	0.69	0.20	P10	0.2	2.26	2.44	0.15	16	17	0.62	24.15	
Pot D	0.65	0.65	0.03	0.59	0.59	0.69	0.20	P10	0.2	1.11	1.20	0.1	12	13	0.62	8.93		

Rekapitulasi Kebutuhan Besi Tulangan Ulir Kolom

No	Tipe	Jenis	Ø Besi Ulir	Berat Tulangan (kg)	Total Berat Tul. (kg)	Volume Beton (m³)	Konversi Tul. dlm 1m³ Beton (kg)	Besi (koef blnxbrt tul) (kg)	Bendrat (koef blnxbrt tul) (kg)
a	b	c	d	e	$f = \sum e$	g	$h = (1/g) * f$	$i = 1.10 * h$	$j = 0.02 * h$
LANTAI 1									
1	K1	Pokok	D25	1143.45	1143.45	2.81	406.92	447.61	8.14
2	K2	Pokok	D25	889.35	889.35	2.75	323.40	355.74	6.47
3	K3	Pokok	D25	889.35	889.35	2.78	319.91	351.90	6.40
4	K4	Pokok	D25	1016.40	1016.40	2.09	486.32	534.95	9.73
5	K5	Pokok	D25	483.56	483.56	2.20	219.80	241.78	4.40
6	K6	Pokok	D25	617.16	617.16	2.20	280.53	308.58	5.61
7	K7	Pokok	D25	725.34	725.34	2.20	329.70	362.67	6.59
8	K8	Pokok	D25	604.45	604.45	2.22	272.27	299.50	5.45
9	K9	Pokok	D25	483.56	483.56	2.22	217.82	239.60	4.36
10	KL1	Pokok	D25	740.59	740.59	1.87	396.04	435.64	7.92
11	KL2	Pokok	D25	1128.90	1128.90	1.82	620.27	682.30	12.41
12	KM1	Pokok	D25	360.13	360.13	2.22	162.22	178.44	3.24
13	KM2	Pokok	D25	600.22	600.22	2.22	270.37	297.41	5.41
14	KM3	Pokok	D25	840.30	840.30	2.22	378.51	416.36	7.57
LANTAI 2									
1	K1	Pokok	D25	1350.27	1350.27	5.08	265.80	292.38	5.32
2	K2	Pokok	D25	681.45	681.45	2.54	268.29	295.12	5.37
3	K3	Pokok	D25	667.13	667.13	2.52	264.73	291.21	5.29
4	K4	Pokok	D25	765.84	765.84	1.89	405.21	445.73	8.10
5	K5	Pokok	D25	366.67	366.67	1.89	194.01	213.41	3.88
6	K6	Pokok	D25	466.47	466.47	1.89	246.81	271.49	4.94
7	K7	Pokok	D25	566.26	566.26	1.89	299.61	329.57	5.99
8	K8	Pokok	D25	566.26	566.26	1.36	416.37	458.00	8.33
9	K9	Pokok	D25	366.67	366.67	1.36	269.61	296.57	5.39
10	K10	Pokok	D25	427.74	427.74	1.14	375.21	412.73	7.50
11	KL1	Pokok	D25	566.26	566.26	1.61	351.71	386.89	7.03
12	KL2	Pokok	D25	898.13	898.13	1.97	455.90	501.49	9.12
13	KM1	Pokok	D25	299.38	299.38	1.36	220.13	242.15	4.40
14	KM2	Pokok	D25	482.71	482.71	1.36	354.93	390.43	7.10
15	KM3	Pokok	D25	666.05	666.05	1.36	489.74	538.72	9.79
LANTAI 3									
1	K2	Pokok	D25	413.95	413.95	2.54	162.97	179.27	3.26
2	K3	Pokok	D25	444.44	444.44	2.52	176.37	194.00	3.53
3	K4	Pokok	D25	531.45	531.45	1.89	281.19	309.31	5.62
4	K5	Pokok	D25	227.77	227.77	1.89	120.51	132.56	2.41
5	K6	Pokok	D25	303.69	303.69	1.89	160.68	176.75	3.21
6	K7	Pokok	D25	303.69	303.69	1.89	160.68	176.75	3.21
7	K8	Pokok	D25	370.37	370.37	1.36	272.33	299.56	5.45
8	K9	Pokok	D25	222.22	222.22	1.36	163.40	179.74	3.27
9	KL1	Pokok	D25	397.61	397.61	1.77	224.64	247.10	4.49
10	KL2	Pokok	D25	683.30	683.30	2.17	314.88	346.37	6.30
11	KM1	Pokok	D25	218.53	218.53	1.36	160.68	176.75	3.21
12	KM2	Pokok	D25	327.79	327.79	1.36	241.02	265.12	4.82
13	KM3	Pokok	D25	437.05	437.05	1.36	321.36	353.50	6.43
ATAP									
1	K1	Pokok	D25	332.64	332.64	2.04	163.06	179.36	3.26
2	K2	Pokok	D25	332.64	332.64	2.04	163.06	179.36	3.26

Rekapitulasi Kebutuhan Besi Tulangan Polos Kolom

No	Type	Jenis	∅ Besi Polos	Berat Tulangan (kg)	Total Berat Tul. (kg)	Volume Beton (m ³)	Konversi Tul. dlm 1m ³ Beton (kg)	Besi (koef bhxbrt tul) (kg)	Bendrat (koef bhxbrt tul) (kg)
a	b	c	d	e	f = ∑ e	g	h = (1/g) * f	i = 1.10 * h	j = 0.02 * h
LANTAI 1									
1	K1	Begel	P12	345.01	345.01	2.81	122.78	135.06	2.46
2	K2	Begel	P12	345.01	345.01	2.75	125.46	138.00	2.51
3	K3	Begel	P10	85.05	159.53	2.78	57.38	63.12	1.15
		Begel susut	P10	37.24					
		Begel susut	P10	37.24					
4	K4	Begel	P10	73.29	186.29	2.09	89.13	98.05	1.78
		Begel susut	P10	56.50					
		Begel susut	P10	56.50					
5	K5	Begel	P10	73.29	73.29	2.20	33.31	36.65	0.67
6	K6	Begel	P10	73.29	73.29	2.20	33.31	36.65	0.67
7	K7	Begel	P10	73.29	73.29	2.20	33.31	36.65	0.67
8	K8	Begel	P10	73.29	73.29	2.22	33.01	36.31	0.66
9	K9	Begel	P10	73.29	73.29	2.22	33.01	36.31	0.66
10	KL1	Begel susut	P10	117.95	117.95	1.87	63.07	69.38	1.26
11	KI.2	Begel susut	P10	117.95	117.95	1.82	64.81	71.29	1.30
12	KM1	Begel	P10	73.29	73.29	2.22	33.01	36.31	0.66
13	KM2	Begel	P10	73.29	73.29	2.22	33.01	36.31	0.66
14	KM3	Begel	P10	73.29	73.29	2.22	33.01	36.31	0.66
LANTAI 2									
1	K1	Begel	P12	1227.08	1227.08	5.08	241.55	265.71	4.83
2	K2	Begel	P12	582.03	582.03	2.54	229.15	252.06	4.58
3	K3	Begel	P10	74.33	136.81	2.52	54.29	59.72	1.09
		Begel susut	P10	31.24					
		Begel susut	P10	31.24					
4	K4	Begel	P10	63.91	147.93	1.89	78.27	86.10	1.57
		Begel susu.	P10	42.01					
		Begel susut	P10	42.01					
5	K5	Begel	P10	63.91	63.91	1.89	33.81	37.20	0.68
6	K6	Begel	P10	63.91	63.91	1.89	33.81	37.20	0.68
7	K7	Begel	P10	63.91	63.91	1.89	33.81	37.20	0.68
8	K8	Begel	P10	53.57	53.57	1.36	39.39	43.33	0.79
9	K9	Begel	P10	53.57	53.57	1.36	39.39	43.33	0.79
10	K10	Begel	P10	51.11	51.11	1.14	44.83	49.32	0.90
11	KI.1	Begel susut	P10	102.86	102.86	1.61	63.89	70.28	1.28
12	KL2	Begel susut	P10	102.86	102.86	1.97	52.21	57.43	1.04
13	KM1	Begel	P10	53.93	53.93	1.36	39.65	43.62	0.79
14	KM2	Begel	P10	53.93	53.93	1.36	39.65	43.62	0.79
15	KM3	Begel	P10	53.93	53.93	1.36	39.65	43.62	0.79

LANTAI 3									
1	K2	Begel	P12	291.02	291.02	2.54	114.57	126.03	2.29
2	K3	Begel	P10	80.08	80.08	2.52	31.78	34.96	0.64
3	K4	Begel	P10	70.52	70.52	1.89	37.31	41.04	0.75
4	K5	Begel	P10	70.52	70.52	1.89	37.31	41.04	0.75
5	K6	Begel	P10	70.52	70.52	1.89	37.31	41.04	0.75
6	K7	Begel	P10	70.52	70.52	1.89	37.31	41.04	0.75
7	K8	Begel	P10	58.43	58.43	1.36	42.96	47.26	0.86
8	K9	Begel	P10	58.43	58.43	1.36	42.96	47.26	0.86
9	KL1	Begel susut	P10	113.50	113.50	1.77	64.12	70.54	1.28
10	KL2	Begel susut	P10	113.50	113.50	2.17	52.30	57.53	1.05
11	KM1	Begel	P10	57.72	57.72	1.36	42.44	46.69	0.85
12	KM2	Begel	P10	57.72	57.72	1.36	42.44	46.69	0.85
13	KM3	Begel	P10	57.72	57.72	1.36	42.44	46.69	0.85
ATAP									
1	K1	Begel	P12	227.66	227.66	2.04	111.60	122.76	2.23
2	K2	Begel	P12	227.66	227.66	2.04	111.60	122.76	2.23

**DAFTAR ANALISA HARGA SATUAN
PEKERJAAN KOLOM**

No	Uraian	Volume	Sat.	Harga Satuan (Rp)	Analisa Harga Bahan (Rp)	Analisa Harga Upah (Rp)	Total Harga Analisa (Rp)
VI	PEKERJAAN BETON KOLOM						
I	KOLOM LANTAI 1						
1	KOLOM K1 (ø 85)						
	BAHAN						
	Paku	0.94	kg	6,000.00	5,652.00		
	Besi ulir	447.61	kg	3,350.00	1,499,493.50		
	Besi polos	135.06	kg	3,000.00	405,180.00		
	Multipleks 15 mm (50%)	1.80	lbr	60,000.00	53,976.00		
	Beton Ready Mix <i>fc' 25 Mpa</i>	1.00	m ³	274,000.00	274,000.00		
	Kayu Bekisting (50%)	0.07	m ³	1,700,000.00	55,675.00		
	Bendrat	10.60	kg	6,500.00	68,900.00		
	Minyak bekisting	0.94	ltr	12,500.00	11,775.00		2,374,651.50
	UPAH BORONGAN						
	Cor ready mix tanpa pompa	1.00	m ³	40,000.00		40,000.00	
	Buat + stel besi	582.67	kg	200.00		116,534.00	
	Bekisting	4.71	m ²	9,250.00		43,567.50	
	Pasang + bongkar scaffolding	4.71	m ²	2,500.00		11,775.00	
	Scaffolding	6.00	set	13,500.00		81,000.00	292,876.50
					Jumlah		2,667,528.00
					Dibulatkan		2,667,528.00
2	KOLOM K2 (ø 85)						
	BAHAN						
	Paku	0.94	kg	6,000.00	5,652.00		
	Besi ulir	335.74	kg	3,350.00	1,124,729.00		
	Besi polos	138.00	kg	3,000.00	414,000.00		
	Multipleks 15 mm (50%)	1.80	lbr	60,000.00	53,976.00		
	Beton Ready Mix <i>fc' 25 Mpa</i>	1.00	m ³	274,000.00	274,000.00		
	Kayu Bekisting (50%)	0.07	m ³	1,700,000.00	55,675.00		
	Bendrat	8.98	kg	6,500.00	58,370.00		
	Minyak bekisting	0.94	ltr	12,500.00	11,775.00		1,998,177.00
	UPAH BORONGAN						
	Cor ready mix tanpa pompa	1.00	m ³	40,000.00		40,000.00	
	Buat + stel besi	473.74	kg	200.00		94,748.00	
	Bekisting	4.71	m ²	9,250.00		43,567.50	
	Pasang + bongkar scaffolding	4.71	m ²	2,500.00		11,775.00	
	Scaffolding	6.00	set	13,500.00		81,000.00	271,090.50
					Jumlah		2,269,267.50
					Dibulatkan		2,269,268.00
3	KOLOM K3 (75x75)						
	BAHAN						
	Paku	1.07	kg	6,000.00	6,399.60		
	Besi ulir	351.90	kg	3,350.00	1,178,865.00		
	Besi polos	63.12	kg	3,000.00	189,360.00		
	Multipleks 15 mm (33.333%)	2.04	lbr	60,000.00	40,743.59		
	Beton Ready Mix <i>fc' 25 Mpa</i>	1.00	m ³	274,000.00	274,000.00		
	Kayu Bekisting (33.333%)	0.07	m ³	1,700,000.00	41,989.58		
	Bendrat	7.55	kg	6,500.00	49,075.00		
	Minyak bekisting	1.07	ltr	12,500.00	13,332.50		1,793,765.27
	UPAH BORONGAN						
	Cor ready mix tanpa pompa	1.00	m ³	40,000.00		40,000.00	
	Buat + stel besi	415.02	kg	200.00		83,004.00	
	Bekisting	5.33	m ²	9,250.00		49,330.25	
	Pasang + bongkar scaffolding	5.33	m ²	2,500.00		13,332.50	
	Scaffolding	6.00	set	13,500.00		81,000.00	266,666.75
					Jumlah		2,060,432.02
					Dibulatkan		2,060,432.00

4	KOLOM K4 (65x65)								
	BAHAN								
	Paku	1.23	kg	6,000.00	7,396.80				
	Besi ulir	534.95	kg	3,350.00	1,792,082.50				
	Besi polos	98.05	kg	3,000.00	291,150.00				
	Multipleks 15 mm (33,333%)	2.35	lbr	60,000.00	47,093.53				
	Beton Ready Mix <i>fc' 25 Mpa</i>	1.00	m ³	274,000.00	274,000.00				
	Kayu Bekisting (33,333%)	0.09	m ³	1,700,000.00	48,562.85				
	Bendrat	11.51	kg	6,500.00	74,815.00				
	Minyak bekisting	1.23	ltr	12,500.00	15,410.00				2,553,510.68
	UPAH BORONGAN								
	Cor ready mix tanpa pompa	1.00	m ³	40,000.00		40,000.00			
	Buat + stel besi	633.00	kg	200.00		126,600.00			
	Bekisting	6.16	m ²	9,250.00		57,017.00			
	Pasang + bongkar scaffolding	6.16	m ²	2,500.00		15,410.00			
	Scaffolding	6.00	set	13,500.00		81,000.00			320,027.00
					Jumlah				2,873,537.68
					Dibulatkan				2,873,538.00
5	KOLOM K5 (65x65)								
	BAHAN								
	Paku	1.23	kg	6,000.00	7,396.80				
	Besi ulir	241.78	kg	3,350.00	809,963.00				
	Besi polos	36.65	kg	3,000.00	109,950.00				
	Multipleks 15 mm (33,333%)	2.35	lbr	60,000.00	47,093.53				
	Beton Ready Mix <i>fc' 25 Mpa</i>	1.00	m ³	274,000.00	274,000.00				
	Kayu Bekisting (33,333%)	0.09	m ³	1,700,000.00	48,562.85				
	Bendrat	5.07	kg	6,500.00	32,955.00				
	Minyak bekisting	1.23	ltr	12,500.00	15,410.00				
	UPAH BORONGAN								
	Cor ready mix tanpa pompa	1.00	m ³	40,000.00		40,000.00			
	Buat + stel besi	278.43	kg	200.00		55,686.00			
	Bekisting	6.16	m ²	9,250.00		57,017.00			
	Pasang + bongkar scaffolding	6.16	m ²	2,500.00		15,410.00			
	Scaffolding	6.00	set	13,500.00		81,000.00			249,113.00
					Jumlah				1,594,444.18
					Dibulatkan				1,594,444.00
6	KOLOM K6 (65x65)								
	BAHAN								
	Paku	1.23	kg	6,000.00	7,396.80				
	Besi ulir	308.58	kg	3,350.00	1,033,743.00				
	Besi polos	36.65	kg	3,000.00	109,950.00				
	Multipleks 15 mm (33,333%)	2.35	lbr	60,000.00	47,093.53				
	Beton Ready Mix <i>fc' 25 Mpa</i>	1.00	m ³	274,000.00	274,000.00				
	Kayu Bekisting (33,333%)	0.09	m ³	1,700,000.00	48,562.85				
	Bendrat	5.28	kg	6,500.00	40,820.00				
	Minyak bekisting	1.23	ltr	12,500.00	15,410.00				
	UPAH BORONGAN								
	Cor ready mix tanpa pompa	1.00	m ³	40,000.00		40,000.00			
	Buat + stel besi	345.23	kg	200.00		69,046.00			
	Bekisting	6.16	m ²	9,250.00		57,017.00			
	Pasang + bongkar scaffolding	6.16	m ²	2,500.00		15,410.00			
	Scaffolding	6.00	set	13,500.00		81,000.00			262,473.00
					Jumlah				1,839,449.18
					Dibulatkan				1,839,449.00
7	KOLOM K7 (65x65)								
	BAHAN								
	Paku	1.23	kg	6,000.00	7,396.80				
	Besi ulir	362.67	kg	3,350.00	1,214,944.50				
	Besi polos	36.65	kg	3,000.00	109,950.00				
	Multipleks 15 mm (33,333%)	2.35	lbr	60,000.00	47,093.53				
	Beton Ready Mix <i>fc' 25 Mpa</i>	1.00	m ³	274,000.00	274,000.00				
	Kayu Bekisting (33,333%)	0.09	m ³	1,700,000.00	48,562.85				
	Bendrat	7.26	kg	6,500.00	47,190.00				
	Minyak bekisting	1.23	ltr	12,500.00	15,410.00				
	UPAH BORONGAN								
	Cor ready mix tanpa pompa	1.00	m ³	40,000.00		40,000.00			
	Buat + stel besi	399.32	kg	200.00		79,864.00			
	Bekisting	6.16	m ²	9,250.00		57,017.00			
	Pasang + bongkar scaffolding	6.16	m ²	2,500.00		15,410.00			
	Scaffolding	6.00	set	13,500.00		81,000.00			273,291.00
					Jumlah				2,037,838.68
					Dibulatkan				2,037,839.00

8	KOLOM K8 (65x65)								
	BAHAN								
	Paku	1.25	kg	6,000.00	7,396.80				
	Besi ulir	299.50	kg	3,350.00	1,003,325.00				
	Besi polos	36.31	kg	3,000.00	108,930.00				
	Multipleks 15 mm (33.333%)	2.35	lbr	60,000.00	47,093.53				
	Beton Ready Mix <i>fc' 25 Mpa</i>	1.00	m ³	274,000.00	274,000.00				
	Kayu Bekisting (33.333%)	0.09	m ³	1,700,000.00	48,562.85				
	Bendrat	6.11	kg	6,500.00	39,715.00				
	Minyak bekisting	1.23	ltr	12,500.00	15,410.00				1,544,433.18
	UPAH BORONGAN								
	Cor ready mix tanpa pompa	1.00	m ³	40,000.00		40,000.00			
	Buat + stel besi	335.81	kg	200.00		67,162.00			
	Bekisting	6.16	m ²	9,250.00		57,017.00			
	Pasang + bongkar scaffolding	6.16	m ²	2,500.00		15,410.00			
	Scaffolding	6.00	set	13,500.00		81,000.00			260,589.00
					Jumlah				1,805,022.18
					Dibulatkan				1,805,022.00
9	KOLOM K9 (65x65)								
	BAHAN								
	Paku	1.23	kg	6,000.00	7,396.80				
	Besi ulir	239.60	kg	3,350.00	802,660.00				
	Besi polos	36.31	kg	3,000.00	108,930.00				
	Multipleks 15 mm (33.333%)	2.35	lbr	60,000.00	47,093.53				
	Beton Ready Mix <i>fc' 25 Mpa</i>	1.00	m ³	274,000.00	274,000.00				
	Kayu Bekisting (33.333%)	0.09	m ³	1,700,000.00	48,562.85				
	Bendrat	5.02	kg	6,500.00	32,630.00				
	Minyak bekisting	1.23	ltr	12,500.00	15,410.00				
	UPAH BORONGAN								
	Cor ready mix tanpa pompa	1.00	m ³	40,000.00		40,000.00			
	Buat + stel besi	275.91	kg	200.00		55,182.00			
	Bekisting	6.16	m ²	9,250.00		57,017.00			
	Pasang + bongkar scaffolding	6.16	m ²	2,500.00		15,410.00			
	Scaffolding	6.00	set	13,500.00		81,000.00			248,649.00
					Jumlah				1,585,272.18
					Dibulatkan				1,586,272.00
10	KOLOM KL1 (L40x65)								
	BAHAN								
	Paku	1.67	kg	6,000.00	9,992.40				
	Besi ulir	435.64	kg	3,350.00	1,459,394.00				
	Besi polos	69.38	kg	3,000.00	208,140.00				
	Multipleks 15 mm (33.333%)	3.18	lbr	60,000.00	63,617.36				
	Beton Ready Mix <i>fc' 25 Mpa</i>	1.00	m ³	274,000.00	274,000.00				
	Kayu Bekisting (33.333%)	0.12	m ³	1,700,000.00	65,562.68				
	Bendrat	9.18	kg	6,500.00	59,670.00				
	Minyak bekisting	1.67	ltr	12,500.00	20,817.50				
	UPAH BORONGAN								
	Cor ready mix tanpa pompa	1.00	m ³	40,000.00		40,000.00			
	Buat + stel besi	505.02	kg	200.00		101,004.00			
	Bekisting	8.33	m ²	9,250.00		77,024.75			
	Pasang + bongkar scaffolding	8.33	m ²	2,500.00		20,817.50			
	Scaffolding	6.00	set	13,500.00		81,000.00			319,846.25
					Jumlah				2,481,040.19
					Dibulatkan				2,481,040.00
11	KOLOM KL2 (L40x65)								
	BAHAN								
	Paku	1.67	kg	6,000.00	9,992.40				
	Besi ulir	682.30	kg	3,350.00	2,285,705.00				
	Besi polos	71.29	kg	3,000.00	213,870.00				
	Multipleks 15 mm (33.333%)	3.18	lbr	60,000.00	63,617.36				
	Beton Ready Mix <i>fc' 25 Mpa</i>	1.00	m ³	274,000.00	274,000.00				
	Kayu Bekisting (33.333%)	0.12	m ³	1,700,000.00	65,562.68				
	Bendrat	13.71	kg	6,500.00	89,115.00				
	Minyak bekisting	1.67	ltr	12,500.00	20,817.50				
	UPAH BORONGAN								
	Cor ready mix tanpa pompa	1.00	m ³	40,000.00		40,000.00			
	Buat + stel besi	753.59	kg	200.00		150,718.00			
	Bekisting	8.33	m ²	9,250.00		77,024.75			
	Pasang + bongkar scaffolding	8.33	m ²	2,500.00		20,817.50			
	Scaffolding	6.00	set	13,500.00		81,000.00			369,560.25
					Jumlah				3,392,240.19
					Dibulatkan				3,392,240.00

2	KOLOM K2 (ø 85)							
	BAHAN							
	Paku	0.94	kg	6,000.00	5,652.00			
	Besi ulir	295.12	kg	3,350.00	988,652.00			
	Besi polos	252.06	kg	3,000.00	756,180.00			
	Multipleks 15 mm (50%)	1.80	lbr	60,000.00	53,976.00			
	Beton Ready Mix <i>fc' 25 Mpa</i>	1.00	m ³	274,000.00	274,000.00			
	Kayu Bekisting (50%)	0.07	m ³	1,700,000.00	55,675.00			
	Bendrat	9.95	kg	6,500.00	64,675.00			
	Minyak bekisting	0.94	ltr	12,500.00	11,775.00			2,210,585.00
	UPAH BORONGAN							
	Cor ready mix tanpa pompa	1.00	m ³	41,500.00		41,500.00		
	Buat + stel besi	547.18	kg	215.00		117,643.70		
	Bekisting	4.71	m ²	10,175.00		47,924.25		
	Pasang + bongkar scaffolding	4.71	m ²	2,750.00		12,952.50		
	Scaffolding	6.00	set	13,500.00		81,000.00		301,020.45
								2,511,605.45
					Jumlah			2,511,605.00
					Dibulatkan			2,511,605.00
3	KOLOM K3 (75x75)							
	BAHAN							
	Paku	1.07	kg	6,000.00	6,399.60			
	Besi ulir	291.21	kg	3,350.00	975,553.50			
	Besi polos	59.72	kg	3,000.00	179,160.00			
	Multipleks 15 mm (36,667%)	2.04	lbr	60,000.00	41,151.85			
	Beton Ready Mix <i>fc' 25 Mpa</i>	1.00	m ³	274,000.00	274,000.00			
	Kayu Bekisting (36,667%)	0.07	m ³	1,700,000.00	42,410.32			
	Bendrat	6.38	kg	6,500.00	41,470.00			
	Minyak bekisting	1.07	ltr	12,500.00	13,332.50			
	UPAH BORONGAN							
	Cor ready mix tanpa pompa	1.00	m ³	41,500.00		41,500.00		
	Buat + stel besi	350.93	kg	215.00		75,449.95		
	Bekisting	5.33	m ²	10,175.00		54,263.28		
	Pasang + bongkar scaffolding	5.33	m ²	2,750.00		14,665.75		
	Scaffolding	6.00	set	13,500.00		81,000.00		266,878.98
								1,840,356.74
					Jumlah			1,840,357.00
					Dibulatkan			1,840,357.00
4	KOLOM K4 (65x65)							
	BAHAN							
	Paku	1.23	kg	6,000.00	7,396.80			
	Besi ulir	445.73	kg	3,350.00	1,493,195.50			
	Besi polos	86.10	kg	3,000.00	258,300.00			
	Multipleks 15 mm (36,667%)	2.35	lbr	60,000.00	47,565.41			
	Beton Ready Mix <i>fc' 25 Mpa</i>	1.00	m ³	274,000.00	274,000.00			
	Kayu Bekisting (36,667%)	0.09	m ³	1,700,000.00	49,049.45			
	Bendrat	9.67	kg	6,500.00	62,855.00			
	Minyak bekisting	1.23	ltr	12,500.00	15,410.00			
	UPAH BORONGAN							
	Cor ready mix tanpa pompa	1.00	m ³	41,500.00		41,500.00		
	Buat + stel besi	531.83	kg	215.00		114,343.45		
	Bekisting	6.16	m ²	10,175.00		62,718.70		
	Pasang + bongkar scaffolding	6.16	m ²	2,750.00		16,951.00		
	Scaffolding	6.00	set	13,500.00		81,000.00		316,513.15
								2,524,285.31
					Jumlah			2,524,285.00
					Dibulatkan			2,524,285.00
5	KOLOM K5 (65x65)							
	BAHAN							
	Paku	1.23	kg	6,000.00	7,396.80			
	Besi ulir	213.41	kg	3,350.00	714,923.50			
	Besi polos	37.20	kg	3,000.00	111,600.00			
	Multipleks 15 mm (36,667%)	2.35	lbr	60,000.00	47,565.41			
	Beton Ready Mix <i>fc' 25 Mpa</i>	1.00	m ³	274,000.00	274,000.00			
	Kayu Bekisting (36,667%)	0.09	m ³	1,700,000.00	49,049.45			
	Bendrat	4.56	kg	6,500.00	29,640.00			
	Minyak bekisting	1.23	ltr	12,500.00	15,410.00			
	UPAH BORONGAN							
	Cor ready mix tanpa pompa	1.00	m ³	41,500.00		41,500.00		
	Buat + stel besi	250.61	kg	215.00		53,881.15		
	Bekisting	5.16	m ²	10,175.00		62,718.70		
	Pasang + bongkar scaffolding	6.16	m ²	2,750.00		16,951.00		
	Scaffolding	6.00	set	13,500.00		81,000.00		256,050.85
								1,505,636.01
					Jumlah			1,505,636.01
					Dibulatkan			1,505,636.00

6	KOLOM K6 (65x65)							
	BAHAN							
	Paku	1.23	kg	6,000.00	7,396.80			
	Besi ulir	271.49	kg	3,350.00	909,491.50			
	Besi polos	37.20	kg	3,000.00	111,600.00			
	Multipleks 15 mm (36,667%)	2.35	lbr	60,000.00	47,565.41			
	Beton Ready Mix <i>fc' 25 Mpa</i>	1.00	m ³	274,000.00	274,000.00			
	Kayu Bekisting (36,667%)	0.09	m ³	1,700,000.00	49,049.45			
	Bendrat	5.62	kg	6,500.00	36,530.00			
	Minyak bekisting	1.23	ltr	12,500.00	15,410.00			1.451,043.16
	UPAH BORONGAN							
	Cor ready mix tanpa pompa	1.00	m ³	41,500.00		41,500.00		
	Buat + stel besi	308.69	kg	215.00		66,368.35		
	Bekisting	6.16	m ²	10,175.00		62,718.70		
	Pasang + bongkar scaffolding	6.16	m ²	2,750.00		16,951.00		
	Scaffolding	6.00	set	13,500.00		81,000.00		268,538.05
					Jumlah			1,719,581.21
					Dibulatkan			1,719,581.00
7	KOLOM K7 (65x65)							
	BAHAN							
	Paku	1.23	kg	6,000.00	7,396.80			
	Besi ulir	329.57	kg	3,350.00	1,104,059.50			
	Besi polos	37.20	kg	3,000.00	111,600.00			
	Multipleks 15 mm (36,667%)	2.35	lbr	60,000.00	47,565.41			
	Beton Ready Mix <i>fc' 25 Mpa</i>	1.00	m ³	274,000.00	274,000.00			
	Kayu Bekisting (36,667%)	0.09	m ³	1,700,000.00	49,049.45			
	Bendrat	6.67	kg	6,500.00	43,355.00			
	Minyak bekisting	1.23	ltr	12,500.00	15,410.00			1.652,436.16
	UPAH BORONGAN							
	Cor ready mix tanpa pompa	1.00	m ³	41,500.00		41,500.00		
	Buat + stel besi	366.77	kg	215.00		78,855.55		
	Bekisting	6.16	m ²	10,175.00		62,718.70		
	Pasang + bongkar scaffolding	6.16	m ²	2,750.00		16,951.00		
	Scaffolding	6.00	set	13,500.00		81,000.00		281,025.25
					Jumlah			1,933,461.41
					Dibulatkan			1,933,461.00
8	KOLOM K8 (55x55)							
	BAHAN							
	Paku	1.45	kg	6,000.00	8,700.00			
	Besi ulir	458.00	kg	3,350.00	1,534,300.00			
	Besi polos	43.33	kg	3,000.00	129,990.00			
	Multipleks 15 mm (36,667%)	2.77	lbr	60,000.00	55,938.39			
	Beton Ready Mix <i>fc' 25 Mpa</i>	1.00	m ³	274,000.00	274,000.00			
	Kayu Bekisting (36,667%)	0.10	m ³	1,700,000.00	57,691.77			
	Bendrat	9.12	kg	6,500.00	59,280.00			
	Minyak bekisting	1.45	ltr	12,500.00	18,125.00			2.138,025.17
	UPAH BORONGAN							
	Cor ready mix tanpa pompa	1.00	m ³	41,500.00		41,500.00		
	Buat + stel besi	501.33	kg	215.00		107,785.95		
	Bekisting	7.25	m ²	10,175.00		73,768.75		
	Pasang + bongkar scaffolding	7.25	m ²	2,750.00		19,937.50		
	Scaffolding	6.00	set	13,500.00		81,000.00		323,992.20
					Jumlah			2,462,017.37
					Dibulatkan			2,462,017.00
9	KOLOM K9 (55x55)							
	BAHAN							
	Paku	1.45	kg	6,000.00	8,700.00			
	Besi ulir	296.57	kg	3,350.00	993,509.50			
	Besi polos	43.33	kg	3,000.00	129,990.00			
	Multipleks 15 mm (36,667%)	2.77	lbr	60,000.00	55,938.39			
	Beton Ready Mix <i>fc' 25 Mpa</i>	1.00	m ³	274,000.00	274,000.00			
	Kayu Bekisting (36,667%)	0.10	m ³	1,700,000.00	57,691.77			
	Bendrat	6.18	kg	6,500.00	40,170.00			
	Minyak bekisting	1.45	ltr	12,500.00	18,125.00			1,578,124.67
	UPAH BORONGAN							
	Cor ready mix tanpa pompa	1.00	m ³	41,500.00		41,500.00		
	Buat + stel besi	339.90	kg	215.00		73,078.50		
	Bekisting	7.25	m ²	10,175.00		73,768.75		
	Pasang + bongkar scaffolding	7.25	m ²	2,750.00		19,937.50		
	Scaffolding	6.00	set	13,500.00		81,000.00		289,284.75
					Jumlah			1,867,409.42
					Dibulatkan			1,867,409.00

14	KOLOM KM2 (65x65)							
	BAHAN							
	Paku	1.45	kg	6,000.00	8,700.00			
	Besi ulir	390.43	kg	3,350.00	1,307,940.50			
	Besi polos	43.62	kg	3,000.00	130,860.00			
	Multipleks 15 mm (36,667%)	2.77	lbr	60,000.00	55,938.39			
	Beton Ready Mix <i>fc' 25 Mpa</i>	1.00	m ³	274,000.00	274,000.00			
	Kayu Bekisting (36,667%)	0.10	m ³	1,700,000.00	57,691.77			
	Bendrat	7.89	kg	6,500.00	51,285.00			
	Minyak bekisting	1.45	ltr	12,500.00	18,125.00			1,904,540.67
	UPAH BORONGAN							
	Cor ready mix tanpa pompa	1.00	m ³	41,500.00		41,500.00		
	Buat + stel besi	434.05	kg	215.00		93,320.75		
	Bekisting	7.25	m ²	10,175.00		73,768.75		
	Pasang + bongkar scaffolding	7.25	m ²	2,750.00		19,937.50		
	Scaffolding	6.00	set	13,500.00		81,000.00		309,527.00
					Jumlah			2,214,067.67
					Dibulatkan			2,214,068.00
15	KOLOM KM3 (65x65)							
	BAHAN							
	Paku	1.45	kg	6,000.00	8,700.00			
	Besi ulir	538.72	kg	3,350.00	1,804,712.00			
	Besi polos	43.62	kg	3,000.00	130,860.00			
	Multipleks 15 mm (36,667%)	2.77	lbr	60,000.00	55,938.39			
	Beton Ready Mix <i>fc' 25 Mpa</i>	1.00	m ³	274,000.00	274,000.00			
	Kayu Bekisting (36,667%)	0.10	m ³	1,700,000.00	57,691.77			
	Bendrat	10.58	kg	6,500.00	68,770.00			
	Minyak bekisting	1.45	ltr	12,500.00	18,125.00			2,418,797.17
	UPAH BORONGAN							
	Cor ready mix tanpa pompa	1.00	m ³	41,500.00		41,500.00		
	Buat + stel besi	582.34	kg	215.00		125,203.10		
	Bekisting	7.25	m ²	10,175.00		73,768.75		
	Pasang + bongkar scaffolding	7.25	m ²	2,750.00		19,937.50		
	Scaffolding	6.00	set	13,500.00		81,000.00		341,409.35
					Jumlah			2,760,206.52
					Dibulatkan			2,760,207.00
III	KOLOM LANTAI 3							
1	KOLOM K2 (ø 85)							
	BAHAN							
	Paku	0.94	kg	6,000.00	5,652.00			
	Besi ulir	179.27	kg	3,350.00	600,554.50			
	Besi polos	126.03	kg	3,000.00	378,090.00			
	Multipleks 15 mm (50%)	1.30	lbr	60,000.00	53,976.00			
	Beton Ready Mix <i>fc' 25 Mpa</i>	1.00	m ³	274,000.00	274,000.00			
	Kayu Bekisting (50%)	0.07	m ³	1,700,000.00	55,675.00			
	Bendrat	5.55	kg	6,500.00	36,075.00			
	Minyak bekisting	0.94	ltr	12,500.00	11,775.00			1,415,797.50
	UPAH BORONGAN							
	Cor ready mix tanpa pompa	1.00	m ³	43,000.00		43,000.00		
	Buat + stel besi	305.30	kg	230.00		70,219.00		
	Bekisting	4.71	m ²	11,100.00		52,281.00		
	Pasang + bongkar scaffolding	4.71	m ²	3,050.00		14,365.50		
	Scaffolding	6.00	set	13,500.00		81,000.00		260,865.50
					Jumlah			1,676,663.00
					Dibulatkan			1,676,663.00
2	KOLOM K3 (75x75)							
	BAHAN							
	Paku	1.07	kg	6,000.00	6,399.60			
	Besi ulir	194.00	kg	3,350.00	649,900.00			
	Besi polos	34.96	kg	3,000.00	104,880.00			
	Multipleks 15 mm (36,667%)	2.04	lbr	60,000.00	41,151.85			
	Beton Ready Mix <i>fc' 25 Mpa</i>	1.00	m ³	274,000.00	274,000.00			
	Kayu Bekisting (36,667%)	0.07	m ³	1,700,000.00	42,410.32			
	Bendrat	4.17	kg	6,500.00	27,105.00			
	Minyak bekisting	1.07	ltr	12,500.00	13,332.50			1,159,179.27
	UPAH BORONGAN							
	Cor ready mix tanpa pompa	1.00	m ³	43,000.00		43,000.00		
	Buat + stel besi	228.96	kg	230.00		52,660.80		
	Bekisting	5.33	m ²	11,100.00		59,196.30		
	Pasang + bongkar scaffolding	5.33	m ²	3,050.00		16,265.65		
	Scaffolding	6.00	set	13,500.00		81,000.00		252,122.75
					Jumlah			1,411,302.02
					Dibulatkan			1,411,302.00

3	KOLOM K4 (65x65)							
	BAHAN							
	Paku	1.23	kg	6,000.00	7,396.80			
	Besi ulir	309.31	kg	3,350.00	1,036,188.50			
	Besi polos	41.04	kg	3,000.00	123,120.00			
	Multipleks 15 mm (36,667%)	2.35	lbr	60,000.00	47,565.41			
	Beton Ready Mix <i>fc' 25 Mpa</i>	1.00	m ³	274,000.00	274,000.00			
	Kayu Bekisting (36,667%)	0.09	m ³	1,700,000.00	49,049.45			
	Bendrat	6.37	kg	6,500.00	41,405.00			
	Minyak bekisting	1.23	ltr	12,500.00	15,410.00			1,594,135.16
	UPAH BORONGAN							
	Cor ready mix tanpa pompa	1.00	m ³	43,000.00		43,000.00		
	Buat + stel besi	350.35	kg	230.00		80,580.50		
	Bekisting	6.16	m ²	11,100.00		68,420.40		
	Pasang + bongkar scaffolding	6.16	m ²	3,050.00		18,800.20		
	Scaffolding	6.00	set	13,500.00		81,000.00		291,801.10
					Jumlah			1,885,936.26
					Dibulatkan			1,885,936.00
4	KOLOM K5 (65x65)							
	BAHAN							
	Paku	1.23	kg	6,000.00	7,396.80			
	Besi ulir	122.56	kg	3,350.00	444,076.00			
	Besi polos	41.04	kg	3,000.00	123,120.00			
	Multipleks 15 mm (36,667%)	2.35	lbr	60,000.00	47,565.41			
	Beton Ready Mix <i>fc' 25 Mpa</i>	1.00	m ³	274,000.00	274,000.00			
	Kayu Bekisting (36,667%)	0.09	m ³	1,700,000.00	49,049.45			
	Bendrat	3.16	kg	6,500.00	20,540.00			
	Minyak bekisting	1.23	ltr	12,500.00	15,410.00			981,157.66
	UPAH BORONGAN							
	Cor ready mix tanpa pompa	1.00	m ³	43,000.00		43,000.00		
	Buat + stel besi	173.60	kg	230.00		39,928.00		
	Bekisting	6.16	m ²	11,100.00		68,420.40		
	Pasang + bongkar scaffolding	6.16	m ²	3,050.00		18,800.20		
	Scaffolding	6.00	set	13,500.00		81,000.00		251,148.60
					Jumlah			1,232,306.26
					Dibulatkan			1,232,306.00
5	KOLOM K6 (65x65)							
	BAHAN							
	Paku	1.23	kg	6,000.00	7,396.80			
	Besi ulir	176.75	kg	3,350.00	592,112.50			
	Besi polos	41.04	kg	3,000.00	123,120.00			
	Multipleks 15 mm (36,667%)	2.35	lbr	60,000.00	47,565.41			
	Beton Ready Mix <i>fc' 25 Mpa</i>	1.00	m ³	274,000.00	274,000.00			
	Kayu Bekisting (36,667%)	0.09	m ³	1,700,000.00	49,049.45			
	Bendrat	3.96	kg	6,500.00	25,740.00			
	Minyak bekisting	1.23	ltr	12,500.00	15,410.00			1,134,394.16
	UPAH BORONGAN							
	Cor ready mix tanpa pompa	1.00	m ³	43,000.00		43,000.00		
	Buat + stel besi	217.79	kg	230.00		50,091.70		
	Bekisting	6.16	m ²	11,100.00		68,420.40		
	Pasang + bongkar scaffolding	6.16	m ²	3,050.00		18,800.20		
	Scaffolding	6.00	set	13,500.00		81,000.00		261,312.30
					Jumlah			1,395,706.46
					Dibulatkan			1,395,706.00
6	KOLOM K7 (65x65)							
	BAHAN							
	Paku	1.23	kg	6,000.00	7,396.80			
	Besi ulir	176.75	kg	3,350.00	592,112.50			
	Besi polos	41.04	kg	3,000.00	123,120.00			
	Multipleks 15 mm (36,667%)	2.35	lbr	60,000.00	47,565.41			
	Beton Ready Mix <i>fc' 25 Mpa</i>	1.00	m ³	274,000.00	274,000.00			
	Kayu Bekisting (36,667%)	0.09	m ³	1,700,000.00	49,049.45			
	Bendrat	3.96	kg	6,500.00	25,740.00			
	Minyak bekisting	1.23	ltr	12,500.00	15,410.00			1,134,394.16
	UPAH BORONGAN							
	Cor ready mix tanpa pompa	1.00	m ³	43,000.00		43,000.00		
	Buat + stel besi	217.79	kg	230.00		50,091.70		
	Bekisting	6.16	m ²	11,100.00		68,420.40		
	Pasang + bongkar scaffolding	6.16	m ²	3,050.00		18,800.20		
	Scaffolding	6.00	set	13,500.00		81,000.00		261,312.30
					Jumlah			1,395,706.46
					Dibulatkan			1,395,706.00

1	KOLOM ATAP							
	KOLOM K1 (Ø 85)							
	BAHAN							
	Paku	0.94	kg	6,000.00	5,652.00			
	Besi ulir	179.36	kg	3,350.00	600,856.00			
	Besi polos	122.76	kg	3,000.00	368,280.00			
	Multipleks 15 mm (50%)	1.80	lbr	60,000.00	53,976.00			
	Beton Ready Mix <i>f_c' 25 Mpa</i>	1.00	m ³	274,000.00	274,000.00			
	Kayu Bekisting (50%)	0.07	m ³	1,700,000.00	55,675.00			
	Bendrat	5.49	kg	6,500.00	35,685.00			
	Minyak bekisting	0.94	ltr	12,500.00	11,775.00			1,405,899.00
	UPAH BOPONGAN							
	Cor ready mix tanpa pompa	1.00	m ³	44,500.00		44,500.00		
	Buat + stel besi	302.12	kg	245.00		74,019.40		
	Bekisting	4.71	m ²	12,025.00		56,637.75		
	Pasang + bongkar scaffolding	4.71	m ²	3,350.00		15,778.50		
	Scaffolding	6.00	set	13,500.00		81,000.00		271,935.65
					Jumlah			1,677,834.65
					Dibulatkan			1,677,835.00
2	KOLOM K2 (Ø 85)							
	BAHAN							
	Paku	0.94	kg	6,000.00	5,652.00			
	Besi ulir	179.36	kg	3,350.00	600,856.00			
	Besi polos	122.76	kg	3,000.00	368,280.00			
	Multipleks 15 mm (50%)	1.80	lbr	60,000.00	53,976.00			
	Beton Ready Mix <i>f_c' 25 Mpa</i>	1.00	m ³	274,000.00	274,000.00			
	Kayu Bekisting (50%)	0.07	m ³	1,700,000.00	55,675.00			
	Bendrat	5.49	kg	6,500.00	35,685.00			
	Minyak bekisting	0.94	ltr	12,500.00	11,775.00			1,405,899.00
	UPAH BORONGAN							
	Cor ready mix tanpa pompa	1.00	m ³	44,500.00		44,500.00		
	Buat + stel besi	302.12	kg	245.00		74,019.40		
	Bekisting	4.71	m ²	12,025.00		56,637.75		
	Pasang + bongkar scaffolding	4.71	m ²	3,350.00		15,778.50		
	Scaffolding	6.00	set	13,500.00		81,000.00		271,935.65
					Jumlah			1,677,834.65
					Dibulatkan			1,677,835.00

ANALISA HARGA PEKERJAAN KOLOM

No	Uraian Pekerjaan	Volume	Sat.	Harga Satuan (Rp)	Harga Tiap Pekerjaan (Rp)	Harga Total Tiap Pekerjaan (Rp)
VI	PEKERJAAN KOLOM					
I	LANTAI I					
1	Beton kolom K1 (Ø85)	5.62	m ³	2,606,778.00	14,991,507.36	
2	Beton kolom K2 (Ø85)	5.50	m ³	2,208,517.50	12,146,846.25	
3	Beton kolom K3 (75x75)	5.57	m ³	2,060,432.02	11,476,606.37	
4	Beton kolom K4 (65x65)	12.53	m ³	2,873,537.68	36,062,897.84	
5	Beton kolom K5 (65x65)	21.97	m ³	1,594,444.18	35,029,938.56	
6	Beton kolom K6 (65x65)	4.39	m ³	1,839,449.18	8,075,181.89	
7	Beton kolom K7 (65x65)	8.79	m ³	2,037,838.68	17,912,601.97	
8	Beton kolom K8 (65x65)	8.87	m ³	1,805,022.18	16,010,546.71	
9	Beton kolom K9 (65x65)	17.75	m ³	1,585,292.18	28,138,936.14	
10	Beton kolom KL1 (L40x65)	11.23	m ³	2,481,040.19	27,862,081.35	
11	Beton kolom KL2 (L40x65)	7.27	m ³	3,392,240.19	24,661,586.19	
12	Beton kolom KM1 (65x65)	8.87	m ³	1,360,894.18	12,071,131.35	
13	Beton kolom KM2 (65x65)	4.44	m ³	1,797,342.68	7,980,201.48	
14	Beton kolom KM3 (65x65)	4.44	m ³	2,233,655.18	9,917,428.98	262,337,492.44
II	LANTAI 2					
1	Beton kolom K1 (Ø85)	10.17	m ³	2,485,094.60	25,273,412.08	
2	Beton kolom K2 (Ø85)	5.08	m ³	2,449,677.95	12,444,363.99	
3	Beton kolom K3 (75x75)	5.04	m ³	1,840,356.74	9,275,397.98	
4	Beton kolom K4 (65x65)	11.36	m ³	2,524,285.31	28,675,881.16	
5	Beton kolom K5 (65x65)	18.93	m ³	1,505,636.01	28,501,689.73	
6	Beton kolom K6 (65x65)	3.79	m ³	1,719,581.21	6,517,212.80	
7	Beton kolom K7 (65x65)	7.57	m ³	1,933,461.41	14,636,302.90	
8	Beton kolom K8 (65x65)	5.42	m ³	2,462,017.37	13,344,134.12	
9	Beton kolom K9 (65x65)	10.84	m ³	1,867,409.42	20,242,718.06	
10	Beton kolom K10 (40x65)	4.56	m ³	2,403,740.60	10,961,057.12	
11	Beton kolom KL1 (L40x65)	9.68	m ³	2,324,638.86	22,502,504.20	
12	Beton kolom KL2 (L40x65)	7.88	m ³	2,684,698.85	21,155,426.92	
13	Beton kolom KM1 (65x65)	5.42	m ³	1,667,899.47	9,040,015.10	
14	Beton kolom KM2 (65x65)	2.71	m ³	2,214,067.67	6,000,123.37	
15	Beton kolom KM3 (65x65)	2.71	m ³	2,760,206.52	7,480,159.66	236,050,399.18
III	LANTAI 3					
1	Beton kolom K2 (Ø85)	5.08	m ³	1,613,322.50	8,195,678.30	
2	Beton kolom K3 (75x75)	5.04	m ³	1,411,302.02	7,112,962.17	
3	Beton kolom K4 (65x65)	11.36	m ³	1,885,936.26	21,424,235.95	
4	Beton kolom K5 (65x65)	18.93	m ³	1,232,306.26	23,327,557.56	
5	Beton kolom K6 (65x65)	3.79	m ³	1,395,706.46	5,289,727.50	
6	Beton kolom K7 (65x65)	7.57	m ³	1,395,706.46	10,565,497.93	
7	Beton kolom K8 (65x65)	5.42	m ³	1,907,132.27	10,336,656.88	
8	Beton kolom K9 (65x65)	10.84	m ³	1,464,006.67	15,869,832.25	
9	Beton kolom KL1 (L40x65)	10.65	m ³	1,827,078.59	19,458,386.97	
10	Beton kolom KL2 (L40x65)	8.68	m ³	2,130,781.52	18,495,183.62	
11	Beton kolom KM1 (65x65)	5.42	m ³	1,451,006.37	7,864,454.50	
12	Beton kolom KM2 (65x65)	2.71	m ³	1,777,835.97	4,817,935.47	
13	Beton kolom KM3 (65x65)	2.71	m ³	2,104,701.37	5,703,740.70	158,461,849.78
IV	ATAP					
1	Beton kolom K1 (Ø85)	4.09	m ³	1,613,081.15	6,597,501.90	
2	Beton kolom K2 (Ø85)	4.09	m ³	1,613,081.15	6,597,501.90	13,195,003.81
Harga Total Pekerjaan Kolom						670,044,745.21

Perhitungan Volume Bekisting dan Volume Beton Balok Lantai

No	Type	Jumlah Tipe	Panjang Bersih (m)	Luasan 1	Luasan 2	Lebar 1 (m)	Tinggi 1 (m)	Lebar 2 (m)	Tinggi 2 (m)	Tinggi Pelat (m)	Tinggi Bersih (m)	Volume Bekisting (m ²)	Volume Bekisting Total (m ²)	Volume Beton (m ³)	Volume Beton Total (m ³)
a	b	c	d	e	f	g	h	i	j	k	l = h - k	$m = (2 * l) + (2 * 0.1) + ((1 + (2 * j))) * d$	$n = c * m$	$o = ((g * l) + (i * j)) * d$	$p = c * o$
BALOK INDUK (BALOK T)															
LANTAI 2															
1	G 1	10	10.05	65/50	45/40	0.65	0.50	0.45	0.40	0.12	0.38	22.21	222.11	4.29	42.91
2	G 2	2	10.05	65/50	45/40	0.65	0.50	0.45	0.40	0.12	0.38	22.21	44.42	4.29	8.58
3	G 3	3	10.15	65/50	45/40	0.65	0.50	0.45	0.40	0.12	0.38	22.43	67.29	4.33	13.00
4a	G 4	3	10.15	65/50	45/40	0.65	0.50	0.45	0.40	0.12	0.38	22.43	67.29	4.33	13.00
4b	G 4	4	6.55	65/50	45/40	0.65	0.50	0.45	0.40	0.12	0.38	14.48	57.90	2.80	11.19
5	G 5	3	10.15	65/50	45/40	0.65	0.50	0.45	0.40	0.12	0.38	22.43	67.29	4.33	13.00
6	G 6	4	6.55	65/50	45/40	0.65	0.50	0.45	0.40	0.12	0.38	14.48	57.90	2.80	11.19
7	G 7	2	6.50	65/50	45/40	0.65	0.50	0.45	0.40	0.12	0.38	14.37	28.73	2.78	5.55
8	G 8	2	10.10	65/50	45/40	0.65	0.50	0.45	0.40	0.12	0.38	22.32	44.64	4.31	8.63
9	G 9	14	2.95	65/50	45/40	0.65	0.50	0.45	0.40	0.12	0.38	6.52	91.27	1.26	17.64
10	G 10	10	2.95	65/50	45/40	0.65	0.50	0.45	0.40	0.12	0.38	6.52	65.20	1.26	12.60
11	G 11	4	4.62	65/50	45/40	0.65	0.50	0.45	0.40	0.12	0.38	10.21	40.84	1.97	7.89
12	G 12	8	3.28	65/50	45/40	0.65	0.50	0.45	0.40	0.12	0.38	7.24	57.90	1.40	11.19
JUMLAH												207.84	912.80	40.16	176.36

No	Type	Jenis	Jumlah Tipe	Panjang Bersih (m)	Lebar Balok (m)	Tinggi Balok (h1) (m)	Tinggi Pelat (h2) (m)	Tinggi Bersih (h) (m)	Volume Bekisting (m ²)	Volume Bekisting Total (m ²)	Volume Beton (m ³)	Volume Beton Total (m ³)
a	b	c	d	e	f	g	h	i = g - h	j = (f + (2 * i)) * e	k = d * j	l = f * i * e	m = d * l
BALOK ANAK (SEGIEMPAT)												
LANTAI 2												
13	G 13	40/70	6	6.80	0.40	0.70	0.12	0.58	10.61	63.65	1.58	9.47
14	G 14	40/70	2	5.50	0.40	0.70	0.12	0.58	8.58	17.16	1.28	2.55
15	G 15	40/70	12	3.40	0.40	0.70	0.12	0.58	5.30	63.65	0.79	9.47
16	B 1	40/50	32	10.15	0.40	0.50	0.12	0.38	11.77	376.77	1.54	49.37
17	B 2	40/50	2	10.15	0.40	0.50	0.12	0.38	11.77	23.55	1.54	3.09
18	B 3	40/50	16	6.55	0.40	0.50	0.12	0.38	7.60	121.57	1.00	15.93
19	B 4	40/50	4	6.55	0.40	0.50	0.12	0.38	7.60	30.39	1.00	3.98
20	B 5	40/50	8	3.08	0.40	0.50	0.12	0.38	3.57	28.54	0.47	3.74
JUMLAH									66.80	725.27	9.19	97.59

No	Type	Jumlah Tipe	Panjang Bersih (m)	Luasan 1	Luasan 2	Lebar 1 (m)	Tinggi 1 (m)	Lebar 2 (m)	Tinggi 2 (m)	Tinggi Pelat (m)	Tinggi 1 Bersih (m)	Volume Bekisting (m ²)	Volume Bekisting Total (m ²)	Volume Beton (m ³)	Volume Beton Total (m ³)
a	b	c	d	e	f	g	h	i	j	k	l = h - k	m = ((2*)+(2*0.1)+(1+2*)) * d	n = c * m	o = ((g*)+(1*j)) * d	p = c * o
BALOK INDUK (BALOK T)															
LANTAI 3															
1a	G 1	5	10.05	65/50	45/40	0.65	0.50	0.45	0.40	0.12	0.38	22.21	111.05	4.29	21.46
1b	G 1	2	3.38	65/50	45/40	0.65	0.50	0.45	0.40	0.12	0.38	7.47	14.94	1.44	2.89
2	G 2	4	6.68	65/50	45/40	0.65	0.50	0.45	0.40	0.12	0.38	14.76	59.05	2.85	11.41
3	G 3	3	10.15	65/50	45/40	0.65	0.50	0.45	0.40	0.12	0.38	22.43	67.29	4.33	13.00
4a	G 4	3	10.15	65/50	45/40	0.65	0.50	0.45	0.40	0.12	0.38	22.43	67.29	4.33	13.00
4b	G 4	4	6.55	65/50	45/40	0.65	0.50	0.45	0.40	0.12	0.38	14.48	57.90	2.80	11.19
5	G 5	3	10.15	65/50	45/40	0.65	0.50	0.45	0.40	0.12	0.38	22.43	67.29	4.33	13.00
6	G 6	4	6.55	65/50	45/40	0.65	0.50	0.45	0.40	0.12	0.38	14.48	57.90	2.80	11.19
7	G 7	2	6.50	65/50	45/40	0.65	0.50	0.45	0.40	0.12	0.38	14.37	28.73	2.78	5.55
8	G 8	2	10.10	65/50	45/40	0.65	0.50	0.45	0.40	0.12	0.38	22.32	44.64	4.31	8.63
9	G 9	14	2.95	65/50	45/40	0.65	0.50	0.45	0.40	0.12	0.38	6.52	91.27	1.26	17.64
10	G 10	10	2.95	65/50	45/40	0.65	0.50	0.45	0.40	0.12	0.38	6.52	65.20	1.26	12.60
11	G 11	4	4.62	65/50	45/40	0.65	0.50	0.45	0.40	0.12	0.38	10.21	40.84	1.97	7.89
12	G 12	8	3.28	65/50	45/40	0.65	0.50	0.45	0.40	0.12	0.38	7.24	57.90	1.40	11.19
13a	B L	1	10.15	40/50	10.40	0.40	0.50	0.10	0.40	0.12	0.38	18.88	18.88	1.95	1.95
13b	B L	2	3.28	40/50	10.40	0.40	0.50	0.10	0.40	0.12	0.38	6.09	12.18	0.63	1.26
JUMLAH												862.38	42.74	163.83	
Jumlah												232.83	42.74	163.83	

No	Type	Jenis	Jumlah Tipe	Panjang Bersih (m)	Lebar Balok (m)	Tinggi Balok (h1) (m)	Tinggi Pelat (h2) (m)	Tinggi Bersih (h) (m)	Volume Bekisting (m ²)	Volume Bekisting Total (m ²)	Volume Beton (m ³)	Volume Beton Total (m ³)
a	b	c	d	e	f	g	h	i = g - h	j = (f + (2 * i)) * e	k = d * j	l = f * i * e	m = d * j
BALOK ANAK (SEGIEMPAT)												
LANTAI 3												
13	G 13	40/70	6	6.80	0.40	0.70	0.12	0.58	10.61	63.65	1.58	9.47
14	G 14	40/70	2	5.50	0.40	0.70	0.12	0.58	8.58	17.16	1.28	2.55
15	G 15	40/70	12	3.40	0.40	0.70	0.12	0.58	5.30	63.65	0.79	9.47
16a	B 1	40/50	21	10.15	0.40	0.50	0.12	0.38	11.77	247.25	1.54	32.40
16b	B 1	40/50	4	6.68	0.40	0.50	0.12	0.38	7.74	30.97	1.01	4.06
16c	B 1	40/50	2	3.28	0.40	0.50	0.12	0.38	3.80	7.60	0.50	1.00
17	B 2	40/50	2	10.15	0.40	0.50	0.12	0.38	11.77	23.55	1.54	3.09
18	B 3	40/50	16	6.55	0.40	0.50	0.12	0.38	7.60	121.57	1.00	15.93
19	B 4	40/50	6	6.55	0.40	0.50	0.12	0.38	7.60	45.59	1.00	5.97
20	B 5	40/50	10	3.08	0.40	0.50	0.12	0.38	3.57	35.67	0.47	4.67
JUMLAH									78.35	656.65	10.70	88.60

No	Type	Jumlah Tipe	Panjang Bersih (m)	Luasan 1	Luasan 2	Lebar 1 (m)	Tinggi 1 (m)	Lebar 2 (m)	Tinggi 2 (m)	Tinggi Pelat (m)	Tinggi Bersih (m)	Volume Bekisting (m ²)	Volume Bekisting Total (m ²)	Volume Beton (m ³)	Volume Beton Total (m ³)
a	b	c	d	e	f	g	h	i	i	k	l = h - k	m = (2*)H(2*0.1) + (H(2*))	n = c * m	o = ((g*) + (i*)) * d	p = c * o
BALOK INDUK (BALOK T. ATAP)															
1	G 1	10	10.05	65/50	45/40	0.65	0.50	0.45	0.40	0.12	0.38	22.21	222.11	4.29	42.91
2	G 2	2	10.05	65/50	45/40	0.65	0.50	0.45	0.40	0.12	0.38	22.21	44.42	4.29	8.58
3	G 3	3	10.15	65/50	45/40	0.65	0.50	0.45	0.40	0.12	0.38	22.43	67.29	4.33	13.00
4a	G 4	3	10.15	65/50	45/40	0.65	0.50	0.45	0.40	0.12	0.38	22.43	67.29	4.33	13.00
4b	G 4	4	6.55	65/50	45/40	0.65	0.50	0.45	0.40	0.12	0.38	14.48	57.90	2.80	11.19
5	G 5	4	10.15	65/50	45/40	0.65	0.50	0.45	0.40	0.12	0.38	22.43	89.73	4.33	17.34
6	G 6	4	6.55	65/50	45/40	0.65	0.50	0.45	0.40	0.12	0.38	14.48	57.90	2.80	11.19
7	G 7	2	6.50	65/50	45/40	0.65	0.50	0.45	0.40	0.12	0.38	14.37	28.73	2.78	5.55
8	G 8	2	10.10	65/50	45/40	0.65	0.50	0.45	0.40	0.12	0.38	22.32	44.64	4.31	8.63
9	G 9	14	2.95	65/50	45/40	0.65	0.50	0.45	0.40	0.12	0.38	6.52	91.27	1.26	17.64
10	G 10	10	2.95	65/50	45/40	0.65	0.50	0.45	0.40	0.12	0.38	6.52	65.20	1.26	12.60
11	G 11	4	4.62	65/50	45/40	0.65	0.50	0.45	0.40	0.12	0.38	10.21	40.84	1.97	7.89
JUMLAH												200.60	877.33	38.76	169.51

Perhitungan Kebutuhan Besi Tulangan Pokok Balok Lantai

Tipe	Jenis	ϕ Besi (m)	Jumlah Tulangan	Panjang Tulangan (m)	Kait (m)	Berat Besi (kg/m)	Kebutuhan Besi (m)	Berat Tulangan (kg)	Jumlah Tipe Balok	Berat Total Tulangan (kg)	
a	b	c	d	e	$f = 5 * c$	g	$h = (c+f)*d$	$i = g * h$	j	$k = i * j$	
LANTAI 2											
1. As D-E (As 7 / As 8) ; As 7-8 (As D / As E)											
G1	Tump. atas	0.025	6	2.70	0.13	3.85	16.95	65.26	4	261.03	
		0.025	6	2.70	0.00	3.85	16.20	62.37	4	249.48	
		0.025	8	2.70	0.13	3.85	22.60	87.01	4	348.04	
		0.025	6	2.70	0.00	3.85	16.20	62.37	4	249.48	
	Tump. bawah	0.025	8	1.35	0.00	3.85	10.80	41.58	4	166.32	
		0.025	2	1.35	0.13	3.85	2.95	11.36	4	45.43	
		0.025	8	1.35	0.00	3.85	10.80	41.58	4	166.32	
		Lap. atas	0.025	6	5.40	0.00	3.85	32.40	124.74	4	498.96
	Lap. bawah	0.025	8	8.10	0.00	3.85	64.80	249.48	4	997.92	
	Susut	0.010	2	10.80	0.10	0.62	21.80	13.52	4	54.06	
			0.012	4	10.80	0.12	0.89	43.68	38.88	4	155.50
	<i>Jumlah</i>								798.14		3192.54
1. As E-F (As 7 / As 8), As 4-7 (As D/As E), As 8-11 (As D/As E)											
G1	Tump. atas	0.025	6	2.70	0.13	3.85	16.95	65.26	6	391.55	
		0.025	6	2.70	0.00	3.85	16.20	62.37	6	374.22	
		0.025	6	2.70	0.13	3.85	16.95	65.26	6	391.55	
		0.025	6	2.70	0.00	3.85	16.20	62.37	6	374.22	
	Tump. bawah	0.025	8	2.70	0.00	3.85	21.60	83.16	6	498.96	
		Lap. atas	0.025	6	5.40	0.00	3.85	32.40	124.74	6	748.44
		Lap. bawah	0.025	8	8.10	0.00	3.85	64.80	249.48	6	1496.88
		Susut	0.010	2	10.80	0.10	0.62	21.80	13.52	6	81.10
			0.012	4	10.80	0.12	0.89	43.68	38.88	6	233.25
	<i>Jumlah</i>								765.03		4590.16
	2. As B-D (As 7 / As 8)										
	G2	Tump. atas	0.025	6	2.70	0.13	3.85	16.95	65.26	2	130.52
0.025			6	2.70	0.00	3.85	16.20	62.37	2	124.74	
0.025			8	2.70	0.13	3.85	22.60	87.01	2	174.02	
0.025			6	2.70	0.00	3.85	16.20	62.37	2	124.74	
Tump. bawah		0.025	8	1.35	0.00	3.85	10.80	41.58	2	83.16	
		0.025	1	1.35	0.13	3.85	1.48	5.68	2	11.36	
		0.025	9	1.35	0.00	3.85	12.15	46.78	2	93.56	
		Lap. atas	0.025	6	5.40	0.00	3.85	32.40	124.74	2	249.48
Lap. bawah		0.025	9	8.10	0.00	3.85	72.90	280.67	2	561.33	
Susut		0.010	2	10.80	0.10	0.62	21.80	13.52	2	27.03	
			0.012	4	10.80	0.12	0.89	43.68	38.88	2	77.75
<i>Jumlah</i>								828.84		1657.38	
3. As D-E (As 4 / As 11) ; As 7-8 (As B)											
G3	Tump. atas	0.025	4	2.70	0.13	3.85	11.30	43.51	3	130.52	
		0.025	4	2.70	0.00	3.85	10.80	41.58	3	124.74	
		0.025	4	2.70	0.13	3.85	11.30	43.51	3	130.52	
		0.025	4	2.70	0.00	3.85	10.80	41.58	3	124.74	
	Tump. bawah	0.025	6	2.70	0.25	3.85	17.70	68.15	3	204.44	
		Lap. atas	0.025	4	5.40	0.00	3.85	21.60	83.16	3	249.48
		Lap. bawah	0.025	6	8.10	0.00	3.85	48.60	187.11	3	561.33
		Susut	0.010	2	10.80	0.10	0.62	21.80	13.52	3	40.55
			0.012	4	10.80	0.12	0.89	43.68	38.88	3	116.63
	<i>Jumlah</i>								560.98		1682.93

4a. As D-E (As 2 / As 13) ; As 7-8 (As A)										
G4	Tump. atas	0.025	4	3.50	0.13	3.85	14.50	55.83	3	167.48
		0.025	4	3.50	0.00	3.85	14.00	53.90	3	161.70
		0.025	4	3.50	0.13	3.85	14.50	55.83	3	167.48
		0.025	4	3.50	0.00	3.85	14.00	53.90	3	161.70
	Tump. bawah	0.025	6	4.30	0.00	3.85	25.80	99.33	3	297.99
		0.025	4	5.40	0.00	3.85	21.60	83.16	3	249.48
	Lap. atas	0.025	6	8.10	0.00	3.85	48.60	187.11	3	561.33
		0.010	2	10.80	0.10	0.62	21.80	13.52	3	40.55
	Susut	0.010	2	10.80	0.10	0.62	21.80	13.52	3	40.55
		0.012	4	10.80	0.12	0.89	43.68	38.88	3	116.63
<i>Jumlah</i>								641.44		1924.32
4b. As 2-4 (As D / As E) ; As 11-13 (As D / As E)										
G4	Tump. atas	0.025	2	2.60	0.13	3.85	5.45	20.98	4	83.93
		0.025	4	2.60	0.00	3.85	10.40	40.04	4	160.16
		0.025	2	1.80	0.13	3.85	3.85	14.82	4	59.29
		0.025	4	1.80	0.00	3.85	7.20	27.72	4	110.88
	Tump. bawah	0.025	4	3.50	0.00	3.85	14.00	53.90	4	215.60
		0.025	4	3.60	0.00	3.85	14.40	55.44	4	221.76
	Lap. atas	0.025	4	4.50	0.00	3.85	18.00	69.30	4	277.20
		0.025	1	4.50	0.25	3.85	4.75	18.29	4	73.15
	Susut	0.010	2	7.20	0.10	0.62	14.60	9.05	4	36.21
		0.012	4	7.20	0.12	0.89	29.28	26.06	4	104.24
<i>Jumlah</i>								335.60		1342.41
5. As 7-8 (As F)										
G5	Tump. atas	0.025	2	2.70	0.13	3.85	5.65	21.75	1	21.75
		0.025	4	2.70	0.00	3.85	10.80	41.58	1	41.58
		0.025	2	2.70	0.13	3.85	5.65	21.75	1	21.75
		0.025	4	2.70	0.00	3.85	10.80	41.58	1	41.58
	Tump. bawah	0.025	4	2.00	0.00	3.85	8.00	30.80	1	30.80
		0.025	4	5.40	0.00	3.85	21.60	83.16	1	83.16
	Lap. atas	0.025	4	8.80	0.00	3.85	35.20	135.52	1	135.52
		0.025	1	8.80	0.25	3.85	9.05	34.84	1	34.84
	Susut	0.010	2	10.80	0.10	0.62	21.80	13.52	1	13.52
		0.012	4	10.80	0.12	0.89	43.68	38.88	1	38.88
<i>Jumlah</i>								463.38		463.38
5. As E-F (As 4) ; As E-F (As 11)										
G5	Tump. atas	0.025	2	3.50	0.13	3.85	7.25	27.91	2	55.83
		0.025	4	3.50	0.00	3.85	14.00	53.90	2	107.80
		0.025	2	2.70	0.13	3.85	5.65	21.75	2	43.51
		0.025	4	2.70	0.00	3.85	10.80	41.58	2	83.16
	Tump. bawah	0.025	4	3.50	0.00	3.85	14.00	53.90	2	107.80
		0.025	4	5.40	0.00	3.85	21.60	83.16	2	166.32
	Lap. atas	0.025	4	8.10	0.00	3.85	32.40	124.74	2	249.48
		0.025	2	8.10	0.25	3.85	16.70	64.30	2	128.59
	Susut	0.010	2	10.80	0.10	0.62	21.80	13.52	2	27.03
		0.012	4	10.80	0.12	0.89	43.68	38.88	2	77.75
<i>Jumlah</i>								523.63		1047.26
6. As C-D (As 4 / As 11)										
G6	Tump. atas	0.025	4	1.80	0.13	3.85	7.70	29.65	2	59.29
		0.025	4	1.80	0.00	3.85	7.20	27.72	2	55.44
		0.025	3	2.60	0.13	3.85	8.18	31.47	2	62.95
		0.025	4	2.60	0.00	3.85	10.40	40.04	2	80.08
	Tump. bawah	0.025	6	1.00	0.00	3.85	6.00	23.10	2	46.20
		0.025	5	1.00	0.00	3.85	5.00	19.25	2	38.50
	Lap. atas	0.025	4	3.60	0.00	3.85	14.40	55.44	2	110.88
		0.025	5	5.20	0.00	3.85	26.00	100.10	2	200.20
	Susut	0.025	1	5.20	0.13	3.85	5.33	20.50	2	41.00
		0.010	2	7.20	0.10	0.62	14.60	9.05	2	18.10
		0.012	4	7.20	0.12	0.89	29.28	2	52.12	
<i>Jumlah</i>								382.38		764.76

6. As 5-7 (As B) ; As 8-10 (As B)											
G6	Tump. atas	0.025	2	2.60	0.13	3.85	5.45	20.98	2	41.97	
		0.025	4	2.60	0.00	3.85	10.40	40.04	2	80.08	
		0.025	4	1.80	0.13	3.85	7.70	29.65	2	59.29	
		0.025	4	1.80	0.00	3.85	7.20	27.72	2	55.44	
	Tump. bawah	0.025	4	1.80	0.00	3.85	7.20	27.72	2	55.44	
		0.025	6	1.00	0.00	3.85	6.00	23.10	2	46.20	
		0.025	4	3.60	0.00	3.85	14.40	55.44	2	110.88	
	Lap. atas	0.025	4	5.20	0.00	3.85	20.80	80.08	2	160.16	
	Lap. bawah	0.025	2	5.20	0.25	3.85	10.90	41.97	2	83.93	
	Susut	0.010	2	7.20	0.10	0.62	14.60	9.05	2	18.10	
		0.012	4	7.20	0.12	0.89	29.28	26.06	2	52.12	
<i>Jumlah</i>								381.80		763.61	
7. As 5-7 (As F) ; As 8-10 (As F)											
G7	Tump. atas	0.025	2	1.80	0.13	3.85	3.85	14.82	2	29.65	
		0.025	4	1.80	0.00	3.85	7.20	27.72	2	55.44	
		0.025	3	1.80	0.13	3.85	5.78	22.23	2	44.47	
		0.025	4	1.80	0.00	3.85	7.20	27.72	2	55.44	
	Tump. bawah	0.025	5	2.00	0.00	3.85	10.00	38.50	2	77.00	
		0.025	4	3.60	0.00	3.85	14.40	55.44	2	110.88	
		0.025	5	5.20	0.00	3.85	26.00	100.10	2	200.20	
	Lap. atas	0.025	2	7.20	0.10	0.62	14.60	9.05	2	18.10	
	Lap. bawah	0.025	4	7.20	0.12	0.89	29.28	26.06	2	52.12	
	<i>Jumlah</i>								321.65		643.29
	8. As F-K (As 7 / As 8)										
G8	Tump. atas	0.025	4	2.70	0.13	3.85	11.30	43.51	2	87.01	
		0.025	6	2.70	0.00	3.85	16.20	62.37	2	124.74	
		0.025	4	2.70	0.13	3.85	11.30	43.51	2	87.01	
		0.025	6	2.70	0.00	3.85	16.20	62.37	2	124.74	
	Tump. bawah	0.025	6	1.35	0.00	3.85	8.10	31.19	2	62.37	
		0.025	6	1.35	0.00	3.85	8.10	31.19	2	62.37	
		0.025	4	5.40	0.00	3.85	21.60	83.16	2	166.32	
	Lap. atas	0.025	6	8.10	0.00	3.85	48.60	187.11	2	374.22	
	Lap. bawah	0.010	2	10.80	0.10	0.62	21.80	13.52	2	27.03	
	Susut	0.012	4	10.80	0.12	0.89	43.68	38.88	2	77.75	
	<i>Jumlah</i>								596.78		1193.56
9. As B-C(As5/As10), As F-II(As5/As10), As A-B(As7/As8), As 4-5(AsII/AsI) As 10-11(As II/AsI), As 4-5(AsC), As 10-11(AsC), As 4-5(As F), As 10-11(As F)											
G9	Tump. atas	0.025	2	1.80	0.13	3.85	3.85	14.82	14	207.52	
		0.025	5	1.80	0.00	3.85	9.00	34.65	14	485.10	
		0.025	2	1.80	0.13	3.85	3.85	14.82	14	207.52	
		0.025	5	1.80	0.00	3.85	9.00	34.65	14	485.10	
	Tump. bawah	0.025	5	3.60	0.00	3.85	18.00	69.30	14	970.20	
		0.025	5	1.60	0.00	3.85	8.00	30.80	14	431.20	
		0.025	5	1.60	0.00	3.85	8.00	30.80	14	431.20	
	Lap. atas	0.010	2	3.60	0.10	0.62	7.40	4.59	14	64.23	
	Lap. bawah	0.012	4	3.60	0.12	0.89	14.88	13.24	14	185.40	
	<i>Jumlah</i>								247.68		3467.47
	10. As K-L (As 7 / As 8)										
G10	Tump. atas	0.025	2	1.80	0.13	3.85	3.85	14.82	2	29.65	
		0.025	5	1.80	0.00	3.85	9.00	34.65	2	69.30	
		0.025	2	1.00	0.13	3.85	2.25	8.66	2	17.33	
		0.025	5	1.00	0.00	3.85	5.00	19.25	2	38.50	
	Tump. bawah	0.025	5	2.80	0.00	3.85	14.00	53.90	2	107.80	
		0.025	5	1.60	0.00	3.85	8.00	30.80	2	61.60	
		0.025	5	1.60	0.00	3.85	8.00	30.80	2	61.60	
	Lap. atas	0.010	2	3.60	0.10	0.62	7.40	4.59	2	9.18	
	Lap. bawah	0.012	4	3.60	0.12	0.89	14.88	13.24	2	26.49	
	<i>Jumlah</i>								210.72		421.43

10. As I-K (As 5/As 10) ; As K-L (As 6/As 9) ; As 5-6 (As K) ; As 9-10 (As K) ; As 6-7 (As I) ; As 8-9 (As I)											
G10	Tump. atas	0.025	2	1.80	0.13	3.85	3.85	14.82	8	118.58	
		0.025	4	1.80	0.00	3.85	7.20	27.72	8	221.76	
		0.025	2	1.30	0.13	3.85	3.85	14.82	8	118.58	
		0.025	4	1.80	0.00	3.85	7.20	27.72	8	221.76	
	Tump. bawah	0.025	6	3.60	0.00	3.85	21.60	83.16	8	665.28	
	Lap. atas	0.025	4	1.60	0.00	3.85	6.40	24.64	8	197.12	
	Lap. bawah	0.025	6	1.60	0.00	3.85	9.60	36.96	8	295.68	
	Susut	0.010	2	3.60	0.10	0.62	7.40	4.59	8	36.70	
			0.012	4	3.60	0.12	0.89	14.88	13.24	8	105.95
	<i>Jumlah</i>								247.68		1981.41
11. As 3-4 (As H / As I) ; As 11-12 (As H / As I)											
G11	Tump. atas	0.025	4	2.15	0.13	3.85	9.10	35.04	4	140.14	
		0.025	4	1.35	0.00	3.85	5.40	20.79	4	83.16	
	Tump. bawah	0.025	4	2.80	0.00	3.85	11.20	43.12	4	172.48	
	Lap. atas	0.025	4	2.57	0.00	3.85	10.28	39.58	4	158.31	
	Lap. bawah	0.025	6	3.27	0.00	3.85	19.62	75.54	4	302.15	
	Susut	0.010	2	5.27	0.10	0.62	10.74	6.66	4	26.64	
			0.012	4	5.27	0.12	0.89	21.56	19.19	4	76.75
	<i>Jumlah</i>								239.91		959.63
G12	Tump. atas	0.025	2	1.80	0.13	3.85	3.85	14.82	8	118.58	
		0.025	5	1.80	0.00	3.85	9.00	34.65	8	277.20	
		0.025	2	1.00	0.13	3.85	2.25	8.66	8	69.30	
		0.025	5	1.00	0.00	3.85	5.00	19.25	8	154.00	
	Tump. bawah	0.025	5	2.80	0.00	3.85	14.00	53.90	8	431.20	
	Lap. atas	0.025	5	1.60	0.00	3.85	8.00	30.80	8	246.40	
	Lap. bawah	0.025	5	1.60	0.00	3.85	8.00	30.80	8	246.40	
	Susut	0.010	2	3.60	0.10	0.62	7.40	4.59	8	36.70	
			0.012	4	3.60	0.12	0.89	14.88	13.24	8	105.95
	<i>Jumlah</i>								210.72		1685.73
G13	Tump. atas	0.025	2	1.80	0.13	3.85	3.85	14.82	6	88.94	
		0.025	4	1.80	0.00	3.85	7.20	27.72	6	166.32	
		0.025	3	1.80	0.13	3.85	5.78	22.23	6	133.40	
		0.025	4	1.80	0.00	3.85	7.20	27.72	6	166.32	
	Tump. bawah	0.025	5	2.00	0.00	3.85	10.00	38.50	6	231.00	
	Lap. atas	0.025	4	3.60	0.00	3.85	14.40	55.44	6	332.64	
	Lap. bawah	0.025	5	5.20	0.00	3.85	26.00	100.10	6	600.60	
	Susut	0.012	2	7.20	0.12	0.89	14.64	13.03	6	78.18	
	<i>Jumlah</i>								299.57		1797.40
	G14	Tump. atas	0.025	2	1.80	0.13	3.85	3.85	14.82	2	29.65
0.025			5	1.80	0.00	3.85	9.00	34.65	2	69.30	
0.025			2	1.00	0.13	3.85	2.25	8.66	2	17.33	
0.025			5	1.00	0.00	3.85	5.00	19.25	2	38.50	
Tump. bawah		0.025	5	2.80	0.00	3.85	14.00	53.90	2	107.80	
Lap. atas		0.025	5	1.60	0.00	3.85	8.00	30.80	2	61.60	
Lap. bawah		0.025	5	1.60	0.00	3.85	8.00	30.80	2	61.60	
Susut		0.012	2	3.60	0.12	0.89	7.44	6.62	2	13.24	
<i>Jumlah</i>								199.51		399.01	
G15		Tump. atas	0.025	2	1.80	0.13	3.85	3.85	14.82	12	177.87
	0.025		4	1.80	0.00	3.85	7.20	27.72	12	332.64	
	0.025		2	1.00	0.13	3.85	2.25	8.66	12	103.95	
	0.025		4	1.00	0.00	3.85	4.00	15.40	12	184.80	
	Tump. bawah	0.025	5	2.80	0.00	3.85	14.00	53.90	12	646.80	
	Lap. atas	0.025	4	1.60	0.00	3.85	6.40	24.64	12	295.68	
	Lap. bawah	0.025	5	1.60	0.00	3.85	8.00	30.80	12	369.60	
	Susut	0.012	2	3.60	0.12	0.89	7.44	6.62	12	79.46	
	<i>Jumlah</i>								182.57		2190.80

B1	Tump. atas	0.025	2	2.70	0.13	3.85	5.65	21.75	32	696.08
		0.025	4	2.70	0.00	3.85	10.80	41.58	32	1330.56
		0.025	2	2.70	0.13	3.85	5.65	21.75	32	696.08
		0.025	4	2.70	0.00	3.85	10.80	41.58	32	1330.56
	Tump. bawah	0.025	4	2.70	0.00	3.85	10.80	41.58	32	1330.56
		0.025	4	2.70	0.00	3.85	10.80	41.58	32	1330.56
	Lap. atas	0.025	4	5.40	0.00	3.85	21.60	83.16	32	2661.12
	Lap. bawah	0.025	2	8.10	0.25	3.85	16.70	64.30	32	2057.44
	Susut	0.025	4	8.10	0.00	3.85	32.40	124.74	32	3991.68
	0.012	2	10.80	0.12	0.89	21.84	19.44	32	622.00	
							<i>Jumlah</i>	459.88		14716.08
B2	Tump. atas	0.025	1	2.70	0.13	3.85	2.83	10.88	2	21.75
		0.025	3	2.70	0.00	3.85	8.10	31.19	2	62.37
		0.025	1	2.70	0.13	3.85	2.83	10.88	2	21.75
		0.025	3	2.70	0.00	3.85	8.10	31.19	2	62.37
	Tump. bawah	0.025	3	2.70	0.00	3.85	8.10	31.19	2	62.37
		0.025	3	2.70	0.00	3.85	8.10	31.19	2	62.37
	Lap. atas	0.025	3	5.40	0.00	3.85	16.20	62.37	2	124.74
	Lap. bawah	0.025	1	8.10	0.25	3.85	8.35	32.15	2	64.30
	Susut	0.025	3	8.10	0.00	3.85	24.30	93.56	2	187.11
	0.012	2	10.80	0.12	0.89	21.84	19.44	2	38.88	
							<i>Jumlah</i>	322.82		645.64
B3	Tump. atas	0.025	1	2.20	0.13	3.85	2.33	8.95	16	143.22
		0.025	3	2.20	0.00	3.85	6.60	25.41	16	406.56
		0.025	1	2.20	0.13	3.85	2.33	8.95	16	143.22
		0.025	3	2.20	0.00	3.85	6.60	25.41	16	406.56
	Tump. bawah	0.025	3	2.80	0.00	3.85	8.40	32.34	16	517.44
		0.025	3	2.80	0.00	3.85	8.40	32.34	16	517.44
	Lap. atas	0.025	3	3.60	0.00	3.85	10.80	41.58	16	665.28
	Lap. bawah	0.025	1	5.20	0.25	3.85	5.45	20.98	16	335.72
	Susut	0.025	3	5.20	0.00	3.85	15.60	60.06	16	960.96
	0.012	2	7.20	0.12	0.89	14.64	13.03	16	208.47	
							<i>Jumlah</i>	236.71		3787.43
B4	Tump. atas	0.025	2	2.20	0.13	3.85	4.65	17.90	4	71.61
		0.025	4	2.20	0.00	3.85	8.80	33.88	4	135.52
		0.025	2	1.80	0.13	3.85	3.85	14.82	4	59.29
		0.025	4	1.80	0.00	3.85	7.20	27.72	4	110.88
	Tump. bawah	0.025	4	2.40	0.00	3.85	9.60	36.96	4	147.84
		0.025	4	2.40	0.00	3.85	9.60	36.96	4	147.84
	Lap. atas	0.025	4	3.60	0.00	3.85	14.40	55.44	4	221.76
	Lap. bawah	0.025	2	5.20	0.25	3.85	10.90	41.97	4	167.86
	Susut	0.025	4	5.20	0.00	3.85	20.80	80.08	4	320.32
	0.012	2	7.20	0.12	0.89	14.64	13.03	4	52.12	
							<i>Jumlah</i>	321.80		1287.20
B5	Pokok	0.025	3	4.00	0.00	3.85	12.00	46.20	8	369.60
		0.025	3	4.00	0.00	3.85	12.00	46.20	8	369.60
	Susut	0.012	2	3.60	0.06	0.89	7.32	6.51	8	52.12
							<i>Jumlah</i>	98.91		791.32

Tipe	Jenis	φ Besi (m)	Jumlah Tulangan	Panjang Tulangan (m)	Kait (m)	Berat Besi (kg/m)	Kebutuhan Besi (m)	Berat Tulangan (kg)	Jumlah Tipe Balok	Berat Total Tulangan (kg)
a	b	c	d	e	$f = 5 * c$	g	$h = (e+f)*d$	$i = g * h$	j	$k = i * j$
LANTAI 3										
Ia. As 7-8 (As E)										
G1	Tump. atas	0.025	6	2.70	0.13	3.85	16.95	65.26	1	65.26
		0.025	4	2.70	0.00	3.85	10.80	41.58	1	41.58
		0.025	6	2.70	0.13	3.85	16.95	65.26	1	65.26
		0.025	4	2.70	0.00	3.85	10.80	41.58	1	41.58
	Tump. bawah	0.025	6	2.70	0.00	3.85	16.20	62.37	1	62.37
		0.025	4	5.40	0.00	3.85	21.60	83.16	1	83.16
	Lap. atas	0.025	6	8.10	0.00	3.85	48.60	187.11	1	187.11
	Lap. bawah	0.010	2	10.80	0.10	0.62	21.80	13.52	1	13.52
	Susut	0.012	4	10.80	0.12	0.89	43.68	38.88	1	38.88
<i>Jumlah</i>								598.71		598.71
Ia. As 4-7 (As E) ; As 8-11 (As E)										
G1	Tump. atas	0.025	5	2.70	0.13	3.85	14.13	54.38	2	108.76
		0.025	4	2.70	0.00	3.85	10.80	41.58	2	83.16
		0.025	5	2.70	0.13	3.85	14.13	54.38	2	108.76
		0.025	4	2.70	0.00	3.85	10.80	41.58	2	83.16
	Tump. bawah	0.025	6	2.70	0.00	3.85	16.20	62.37	2	124.74
		0.025	4	5.40	0.00	3.85	21.60	83.16	2	166.32
	Lap. atas	0.025	6	8.10	0.00	3.85	48.60	187.11	2	374.22
	Lap. bawah	0.010	2	10.80	0.10	0.62	21.80	13.52	2	27.03
	Susut	0.012	4	10.80	0.12	0.89	43.68	38.88	2	77.75
<i>Jumlah</i>								576.95		1153.91
Ia. As E-F (As 7 / As 8)										
G1	Tump. atas	0.025	6	2.70	0.13	3.85	16.95	65.26	2	130.52
		0.025	6	2.70	0.00	3.85	16.20	62.37	2	124.74
		0.025	6	2.70	0.13	3.85	16.95	65.26	2	130.52
		0.025	6	2.70	0.00	3.85	16.20	62.37	2	124.74
	Tump. bawah	0.025	6	2.70	0.00	3.85	16.20	62.37	2	124.74
		0.025	6	5.40	0.00	3.85	32.40	124.74	2	249.48
	Lap. atas	0.025	2	8.10	0.13	3.85	16.45	63.33	2	126.67
	Lap. bawah	0.025	6	8.10	0.00	3.85	48.60	187.11	2	374.22
	Susut	0.010	2	10.80	0.10	0.62	21.80	13.52	2	27.03
Susut	0.012	4	10.80	0.12	0.89	43.68	38.88	2	77.75	
<i>Jumlah</i>								706.32		1412.65
I.b. As 7 / As 8										
G1	Tump. atas	0.025	12	1.35	0.00	3.85	16.20	62.37	2	124.74
		0.025	2	1.35	0.13	3.85	2.95	11.36	2	22.72
		0.025	4	1.35	0.00	3.85	5.40	20.79	2	41.58
	Lap. atas	0.025	12	2.95	0.00	3.85	35.40	136.29	2	272.58
		0.025	4	2.95	0.00	3.85	11.80	45.43	2	90.86
	Susut	0.010	2	3.80	0.10	0.62	7.80	4.84	2	9.67
Susut	0.012	4	3.80	0.12	0.89	15.68	13.96	2	27.91	
<i>Jumlah</i>								295.03		590.06
2. As B-D (As 7 / As 8)										
G2	Tump. atas	0.025	7	2.60	0.00	3.85	18.20	70.07	2	140.14
		0.025	4	2.60	0.00	3.85	10.40	40.04	2	80.08
	Lap. atas	0.025	7	5.40	0.00	3.85	37.80	145.53	2	291.06
		0.025	2	5.40	0.13	3.85	11.05	42.54	2	85.09
	Lap. bawah	0.025	4	5.40	0.00	3.85	21.60	83.16	2	166.32
		0.010	2	7.20	0.10	0.62	14.60	9.05	2	18.10
Susut	0.012	4	7.20	0.12	0.89	29.28	26.06	2	52.12	
<i>Jumlah</i>								416.45		832.91

2. As 4-6 (As D) ; As 9-11 (As D)										
G2	Tump. atas	0.025	4	5.40	0.00	3.85	21.60	83.16	2	166.32
		0.025	5	5.40	0.13	3.85	27.63	106.36	2	212.71
	Tump. bawah	0.025	6	6.30	0.00	3.85	37.80	145.53	2	291.06
		0.025	4	2.60	0.00	3.85	10.40	40.04	2	80.08
	Lap. atas	0.025	6	1.70	0.00	3.85	10.20	39.27	2	78.54
	Lap. bawah	0.010	2	7.20	0.10	0.62	14.60	9.05	2	18.10
	Susut	0.012	4	7.20	0.12	0.89	29.28	26.06	2	52.12
<i>Jumlah</i>							449.47			898.93
3. As D-E (As 4 / As 11) ; As 7-8 (As B)										
G3	Tump. atas	0.025	4	2.70	0.13	3.85	11.30	43.51	3	130.52
		0.025	4	2.70	0.00	3.85	10.80	41.58	3	124.74
		0.025	4	2.70	0.13	3.85	11.30	43.51	3	130.52
		0.025	4	2.70	0.00	3.85	10.80	41.58	3	124.74
	Tump. bawah	0.025	6	3.60	0.00	3.85	21.60	83.16	3	249.48
	Lap. atas	0.025	4	5.40	0.00	3.85	21.60	83.16	3	249.48
	Lap. bawah	0.025	6	8.10	0.00	3.85	48.60	187.11	3	561.33
	Susut	0.010	2	10.80	0.10	0.62	21.80	13.52	3	40.55
		0.012	4	10.80	0.12	0.89	43.68	38.88	3	116.63
	<i>Jumlah</i>							575.99		
4a. As D-E (As 2 / As 13) ; As 7-8 (As A)										
G4	Tump. atas	0.025	3	3.50	0.13	3.85	10.88	41.87	3	125.61
		0.025	4	3.50	0.00	3.85	14.00	53.90	3	161.70
		0.025	3	3.50	0.13	3.85	10.88	41.87	3	125.61
		0.025	4	3.50	0.00	3.85	14.00	53.90	3	161.70
	Tump. bawah	0.025	5	2.15	0.00	3.85	10.75	41.39	3	124.16
	Lap. atas	0.025	4	5.40	0.00	3.85	21.60	83.16	3	249.48
	Lap. bawah	0.025	5	8.10	0.00	3.85	40.50	155.93	3	467.78
	Susut	0.010	2	10.80	0.10	0.62	21.80	13.52	3	40.55
		0.012	4	10.80	0.12	0.89	43.68	38.88	3	116.63
	<i>Jumlah</i>							524.40		
4b. As 2-4 (As D / As E) ; As 11-13 (As D / As E)										
G4	Tump. atas	0.025	2	2.60	0.13	3.85	5.45	20.98	4	83.93
		0.025	4	2.60	0.00	3.85	10.40	40.04	4	160.16
		0.025	5	1.80	0.13	3.85	9.63	37.06	4	148.23
		0.025	4	1.80	0.00	3.85	7.20	27.72	4	110.88
	Tump. bawah	0.025	4	1.80	0.00	3.85	7.20	27.72	4	110.88
		0.025	6	1.00	0.13	3.85	6.75	25.99	4	103.95
	Lap. atas	0.025	4	3.60	0.00	3.85	14.40	55.44	4	221.76
	Lap. bawah	0.025	5	5.20	0.13	3.85	26.63	102.51	4	410.03
	Susut	0.010	2	7.20	0.10	0.62	14.60	9.05	4	36.21
		0.012	4	7.20	0.12	0.89	29.28	26.06	4	104.24
<i>Jumlah</i>							372.56			1490.25
5. As 7-8 (As F)										
G5	Tump. atas	0.025	3	2.70	0.13	3.85	8.48	32.63	1	32.63
		0.025	4	2.70	0.00	3.85	10.80	41.58	1	41.58
		0.025	3	2.70	0.13	3.85	8.48	32.63	1	32.63
		0.025	4	2.70	0.00	3.85	10.80	41.58	1	41.58
	Tump. bawah	0.025	5	3.60	0.00	3.85	18.00	69.30	1	69.30
	Lap. atas	0.025	4	5.40	0.00	3.85	21.60	83.16	1	83.16
	Lap. bawah	0.025	5	8.10	0.13	3.85	41.13	158.33	1	158.33
	Susut	0.010	2	10.80	0.10	0.62	21.80	13.52	1	13.52
		0.012	4	10.80	0.12	0.89	43.68	38.88	1	38.88
	<i>Jumlah</i>							511.60		

5. As E-F (As 4) ; As E-F (As 11)											
G5	Tump. atas	0.025	3	3.50	0.13	3.85	10.88	41.87	2	83.74	
		0.025	4	3.50	0.00	3.85	14.00	53.90	2	107.80	
		0.025	4	2.70	0.13	3.85	11.30	43.51	2	87.01	
		0.025	4	2.70	0.00	3.85	10.80	41.58	2	83.16	
	Tump. bawah	0.025	5	2.15	0.00	3.85	10.75	41.39	2	82.78	
		0.025	6	1.35	0.00	3.85	8.10	31.19	2	62.37	
	Lap. atas	0.025	4	5.40	0.00	3.85	21.60	83.16	2	166.32	
	Lap. bawah	0.025	1	8.10	0.13	3.85	8.23	31.67	2	63.33	
		0.025	5	8.10	0.00	3.85	40.50	155.93	2	311.85	
	Susut	0.010	2	10.80	0.10	0.62	21.80	13.52	2	27.03	
		0.012	4	10.80	0.12	0.89	43.68	38.88	2	77.75	
	<i>Jumlah</i>							576.57			1153.14
6. As C-D (As 4 / As 11)											
G6	Tump. atas	0.025	3	2.60	0.13	3.85	8.18	31.47	2	62.95	
		0.025	4	2.60	0.00	3.85	10.40	40.04	2	80.08	
		0.025	4	1.80	0.13	3.85	7.70	29.65	2	59.29	
		0.025	4	1.80	0.00	3.85	7.20	27.72	2	55.44	
	Tump. bawah	0.025	5	1.80	0.00	3.85	9.00	34.65	2	69.30	
		0.025	6	1.00	0.00	3.85	6.00	23.10	2	46.20	
	Lap. atas	0.025	4	3.60	0.00	3.85	14.40	55.44	2	110.88	
	Lap. bawah	0.025	1	5.20	0.13	3.85	5.33	20.50	2	41.00	
		0.025	5	5.20	0.00	3.85	26.00	100.10	2	200.20	
	Susut	0.010	2	7.20	0.10	0.62	14.60	9.05	2	18.10	
		0.012	4	7.20	0.12	0.89	29.28	26.06	2	52.12	
	<i>Jumlah</i>							397.78			795.56
6. As 5-7 (As B) ; As 8-10 (As B)											
G6	Tump. atas	0.025	2	2.60	0.13	3.85	5.45	20.98	2	41.97	
		0.025	4	2.60	0.00	3.85	10.40	40.04	2	80.08	
		0.025	4	1.80	0.13	3.85	7.70	29.65	2	59.29	
		0.025	4	1.80	0.00	3.85	7.20	27.72	2	55.44	
	Tump. bawah	0.025	4	1.80	0.00	3.85	7.20	27.72	2	55.44	
		0.025	6	1.00	0.00	3.85	6.00	23.10	2	46.20	
	Lap. atas	0.025	4	3.60	0.00	3.85	14.40	55.44	2	110.88	
	Lap. bawah	0.025	2	5.20	0.13	3.85	10.65	41.00	2	82.01	
		0.025	4	5.20	0.00	3.85	20.80	80.08	2	160.16	
	Susut	0.010	2	7.20	0.10	0.62	14.60	9.05	2	18.10	
		0.012	4	7.20	0.12	0.89	29.28	26.06	2	52.12	
	<i>Jumlah</i>							380.84			761.68
7. As 5-7 (As F) ; As 8-10 (As F)											
G7	Tump. atas	0.025	2	1.80	0.13	3.85	3.85	14.82	2	29.65	
		0.025	4	1.80	0.00	3.85	7.20	27.72	2	55.44	
		0.025	3	1.80	0.13	3.85	5.78	22.23	2	44.47	
		0.025	4	1.80	0.00	3.85	7.20	27.72	2	55.44	
	Tump. bawah	0.025	5	1.00	0.00	3.85	5.00	19.25	2	38.50	
		0.025	5	1.00	0.00	3.85	5.00	19.25	2	38.50	
	Lap. atas	0.025	4	3.60	0.00	3.85	14.40	55.44	2	110.88	
	Lap. bawah	0.025	5	5.20	0.00	3.85	26.00	100.10	2	200.20	
		0.010	2	7.20	0.10	0.62	14.60	9.05	2	18.10	
	Susut	0.012	4	7.20	0.12	0.89	29.28	26.06	2	52.12	
		<i>Jumlah</i>							321.65		
	8. As F-K (As 7 / As 8)										
G8	Tump. atas	0.025	3	2.70	0.13	3.85	8.48	32.63	2	65.26	
		0.025	4	2.70	0.00	3.85	10.80	41.58	2	83.16	
		0.025	3	2.70	0.13	3.85	8.48	32.63	2	65.26	
		0.025	4	2.70	0.00	3.85	10.80	41.58	2	83.16	
	Tump. bawah	0.025	4	1.35	0.00	3.85	5.40	20.79	2	41.58	
		0.025	6	1.35	0.00	3.85	8.10	31.19	2	62.37	
	Lap. atas	0.025	4	5.40	0.00	3.85	21.60	83.16	2	166.32	
	Lap. bawah	0.025	2	8.10	0.13	3.85	16.45	63.33	2	126.67	
		0.025	4	8.10	0.00	3.85	32.40	124.74	2	249.48	
	Susut	0.010	2	10.80	0.10	0.62	21.80	13.52	2	27.03	
		0.012	4	10.80	0.12	0.89	43.68	38.88	2	77.75	
	<i>Jumlah</i>							524.02			1048.03

9. As 4-5 (As II / As I), As 10-11 (As II / As I), As 4-5 (As C), As 10-11 (As C), As B-C (As 5 / As 10) As F-II (As 5 / As 10), As A-B (As 7 / As 8), As 4-5 (As F), As 10-11 (As F)										
G9	Tump. atas	0.025	2	1.80	0.13	3.85	3.85	14.82	14	207.52
		0.025	5	1.80	0.00	3.85	9.00	34.65	14	485.10
		0.025	2	1.80	0.13	3.85	3.85	14.82	14	207.52
		0.025	5	1.80	0.00	3.85	9.00	34.65	14	485.10
	Tump. bawah	0.025	5	3.60	0.00	3.85	18.00	69.30	14	970.20
		0.025	5	1.60	0.00	3.85	8.00	30.80	14	431.20
	Lap. atas	0.025	5	1.60	0.00	3.85	8.00	30.80	14	431.20
		0.025	5	1.60	0.00	3.85	8.00	30.80	14	431.20
	Lap. bawah	0.010	2	3.60	0.10	0.62	7.40	4.59	14	64.23
		0.012	4	3.60	0.12	0.89	14.88	13.24	14	185.40
<i>Jumlah</i>								247.68		3467.47
10. As K-L (As 7 / As 8)										
G10	Pokok	0.025	4	4.40	0.00	3.85	17.60	67.76	2	135.52
		0.025	4	4.40	0.00	3.85	17.60	67.76	2	135.52
	Susut	0.010	2	3.60	0.10	0.62	7.40	4.59	2	9.18
		0.012	4	3.60	0.12	0.89	14.88	13.24	2	26.49
<i>Jumlah</i>								153.35		306.70
10. As I-K (As 5/As 10) ; As K-L (As 6/As 9) ; As 5-6 (As K) ; As 9-10 (As K) ; As 6-7 (As L) ; As 8-9 (As L)										
G10	Tump. atas	0.025	2	1.80	0.13	3.85	3.85	14.82	8	118.58
		0.025	4	1.80	0.00	3.85	7.20	27.72	8	221.76
		0.025	2	1.80	0.13	3.85	3.85	14.82	8	118.58
		0.025	4	1.80	0.00	3.85	7.20	27.72	8	221.76
	Tump. bawah	0.025	6	3.60	0.00	3.85	21.60	83.16	8	665.28
		0.025	4	1.60	0.00	3.85	6.40	24.64	8	197.12
	Lap. atas	0.025	6	1.60	0.00	3.85	9.60	36.96	8	295.68
		0.025	6	1.60	0.00	3.85	9.60	36.96	8	295.68
	Lap. bawah	0.010	2	3.60	0.10	0.62	7.40	4.59	8	36.70
		0.012	4	3.60	0.12	0.89	14.88	13.24	8	105.95
<i>Jumlah</i>								247.68		1981.41
11. As 3-4 (As H / As I) ; As 11-12 (As H / As I)										
G11	Tump. atas	0.025	4	2.15	0.00	3.85	8.60	33.11	4	132.44
		0.025	4	1.35	0.00	3.85	5.40	20.79	4	83.16
	Tump. bawah	0.025	4	2.80	0.00	3.85	11.20	43.12	4	172.48
		0.025	4	2.57	0.00	3.85	10.28	39.58	4	158.31
	Lap. atas	0.025	4	3.27	0.00	3.85	13.08	50.36	4	201.43
		0.025	4	3.27	0.00	3.85	13.08	50.36	4	201.43
	Lap. bawah	0.010	2	5.27	0.10	0.62	10.74	6.66	4	26.64
		0.012	4	5.27	0.12	0.89	21.56	19.19	4	76.75
<i>Jumlah</i>								212.80		851.21
G12	Tump. atas	0.025	2	1.80	0.13	3.85	3.85	14.82	8	118.58
		0.025	5	1.80	0.00	3.85	9.00	34.65	8	277.20
		0.025	2	1.00	0.13	3.85	2.25	8.66	8	69.30
		0.025	5	1.00	0.00	3.85	5.00	19.25	8	154.00
	Tump. bawah	0.025	5	2.80	0.00	3.85	14.00	53.90	8	431.20
		0.025	5	1.60	0.00	3.85	8.00	30.80	8	246.40
	Lap. atas	0.025	5	1.60	0.00	3.85	8.00	30.80	8	246.40
		0.025	5	1.60	0.00	3.85	8.00	30.80	8	246.40
	Lap. bawah	0.010	2	3.60	0.10	0.62	7.40	4.59	8	36.70
		0.012	4	3.60	0.12	0.89	14.88	13.24	8	105.95
<i>Jumlah</i>								210.72		1685.73
G13	Tump. atas	0.025	2	1.80	0.13	3.85	3.85	14.82	6	88.94
		0.025	4	1.80	0.00	3.85	7.20	27.72	6	166.32
		0.025	3	1.80	0.13	3.85	5.78	22.23	6	133.40
		0.025	4	1.80	0.00	3.85	7.20	27.72	6	166.32
	Tump. bawah	0.025	5	2.00	0.00	3.85	10.00	38.50	6	231.00
		0.025	4	3.60	0.00	3.85	14.40	55.44	6	332.64
	Lap. atas	0.025	5	5.20	0.00	3.85	26.00	100.10	6	600.60
		0.025	5	5.20	0.00	3.85	26.00	100.10	6	600.60
	Lap. bawah	0.010	2	7.20	0.10	0.62	7.40	4.59	6	26.64
		0.012	2	7.20	0.12	0.89	14.64	13.03	6	78.18
<i>Jumlah</i>								299.57		1797.41

G14	Tump. atas	0.025	2	1.80	0.13	3.85	3.85	14.82	2	29.65
		0.025	5	1.80	0.00	3.85	9.00	34.65	2	69.30
		0.025	2	1.00	0.13	3.85	2.25	8.66	2	17.33
		0.025	5	1.00	0.00	3.85	5.00	19.25	2	38.50
	Tump. bawah	0.025	5	2.80	0.00	3.85	14.00	53.90	2	107.80
		Lap. atas	0.025	5	1.60	0.00	3.85	8.00	30.80	2
	Lap. bawah	0.025	5	1.60	0.00	3.85	8.00	30.80	2	61.60
	Susut	0.012	2	3.60	0.12	0.89	7.44	6.62	2	13.24
<i>Jumlah</i>								199.51		399.01
G15	Tump. atas	0.025	2	1.80	0.13	3.85	3.85	14.82	12	177.87
		0.025	4	1.80	0.00	3.85	7.20	27.72	12	332.64
		0.025	2	1.00	0.13	3.85	2.25	8.66	12	103.95
		0.025	4	1.00	0.00	3.85	4.00	15.40	12	184.80
	Tump. bawah	0.025	5	2.80	0.00	3.85	14.00	53.90	12	646.80
		Lap. atas	0.025	4	1.60	0.00	3.85	6.40	24.64	12
	Lap. bawah	0.025	5	1.60	0.00	3.85	8.00	30.80	12	369.60
	Susut	0.012	2	3.60	0.12	0.89	7.44	6.62	12	79.46
<i>Jumlah</i>								182.57		2190.80
B1a	Tump. atas	0.025	2	2.70	0.13	3.85	5.65	21.75	21	456.80
		0.025	4	2.70	0.00	3.85	10.80	41.58	21	873.18
		0.025	2	2.70	0.13	3.85	5.65	21.75	21	456.80
		0.025	4	2.70	0.00	3.85	10.80	41.58	21	873.18
	Tump. bawah	0.025	4	2.70	0.00	3.85	10.80	41.58	21	873.18
		Lap. atas	0.025	4	5.40	0.00	3.85	21.60	83.16	21
	Lap. bawah	0.025	2	8.10	0.25	3.85	16.70	64.30	21	1350.20
	Susut	0.025	4	8.10	0.00	3.85	32.40	124.74	21	2619.54
Susut	0.012	2	10.80	0.12	0.89	21.84	19.44	21	408.19	
<i>Jumlah</i>								459.88		9657.43
B1b	Tump. atas	0.025	2	1.80	0.13	3.85	3.85	14.82	4	59.29
		0.025	4	1.80	0.00	3.85	7.20	27.72	4	110.88
		0.025	2	1.80	0.13	3.85	3.85	14.82	4	59.29
		0.025	4	1.80	0.00	3.85	7.20	27.72	4	110.88
	Tump. bawah	0.025	4	2.00	0.00	3.85	8.00	30.80	4	123.20
		Lap. atas	0.025	4	3.60	0.00	3.85	14.40	55.44	4
	Lap. bawah	0.025	2	5.20	0.25	3.85	10.90	41.97	4	167.86
	Susut	0.025	4	5.20	0.00	3.85	20.80	80.08	4	320.32
Susut	0.012	2	7.20	0.12	0.89	14.64	13.03	4	52.12	
<i>Jumlah</i>								306.40		1225.60
B1c	Pokok	0.025	4	4.00	0.00	3.85	16.00	61.60	2	123.20
		0.025	4	4.00	0.00	3.85	16.00	61.60	2	123.20
	Susut	0.012	2	3.60	0.12	0.89	7.44	6.62	2	13.24
<i>Jumlah</i>								129.82		259.64
B2	Tump. atas	0.025	1	2.70	0.13	3.85	2.83	10.88	2	21.75
		0.025	3	2.70	0.00	3.85	8.10	31.19	2	62.37
		0.025	1	2.70	0.13	3.85	2.83	10.88	2	21.75
		0.025	3	2.70	0.00	3.85	8.10	31.19	2	62.37
	Tump. bawah	0.025	3	2.70	0.00	3.85	8.10	31.19	2	62.37
		Lap. atas	0.025	3	5.40	0.00	3.85	16.20	62.37	2
	Lap. bawah	0.025	1	8.10	0.25	3.85	8.35	32.15	2	64.30
	Susut	0.025	3	8.10	0.00	3.85	24.30	93.56	2	187.11
Susut	0.012	2	10.80	0.12	0.89	21.84	19.44	2	48.88	
<i>Jumlah</i>								322.82		645.64

B3	Tump. atas	0.025	1	2.20	0.13	3.85	2.33	8.95	16	143.22
		0.025	3	2.20	0.00	3.85	6.60	25.41	16	406.56
		0.025	1	2.20	0.13	3.85	2.33	8.95	16	143.22
	Tump. bawah	0.025	3	2.20	0.00	3.85	6.60	25.41	16	406.56
		0.025	3	2.80	0.00	3.85	8.40	32.34	16	517.44
		0.025	3	3.60	0.00	3.85	10.80	41.58	16	665.28
	Lap. atas	0.025	1	5.20	0.25	3.85	5.45	20.98	16	335.72
	Lap. bawah	0.025	3	5.20	0.00	3.85	15.60	60.06	16	960.96
	Susut	0.012	2	7.20	0.12	0.89	14.64	13.03	16	208.47
<i>Jumlah</i>								236.71		3787.43
B4	Tun p. atas	0.025	2	2.20	0.13	3.85	4.65	17.90	6	107.42
		0.025	4	2.20	0.00	3.85	8.80	33.88	6	203.28
		0.025	2	1.80	0.13	3.85	3.85	14.82	6	88.94
	Tump. bawah	0.025	4	1.80	0.00	3.85	7.20	27.72	6	166.32
		0.025	4	2.40	0.00	3.85	9.60	36.96	6	221.76
		0.025	4	3.60	0.00	3.85	14.40	55.44	6	332.64
	Lap. atas	0.025	2	5.20	0.25	3.85	10.90	41.97	6	251.79
	Lap. bawah	0.025	4	5.20	0.00	3.85	20.80	80.08	6	480.48
	Susut	0.012	2	7.20	0.12	0.89	14.64	13.03	6	78.18
<i>Jumlah</i>								321.80		1930.80
B5	Pokok	0.025	3	4.00	0.00	3.85	12.00	46.20	10	462.00
		0.025	3	4.00	0.00	3.85	12.00	46.20	10	462.00
	Susut	0.012	2	3.60	0.06	0.89	7.32	6.51	10	65.15
<i>Jumlah</i>								98.91		989.15
BLa	Tump. atas	0.025	2	2.70	0.13	3.85	5.65	21.75	1	21.75
		0.025	4	2.70	0.00	3.85	10.80	41.58	1	41.58
		0.025	2	2.70	0.13	3.85	5.65	21.75	1	21.75
	Tump. bawah	0.025	4	2.70	0.00	3.85	10.80	41.58	1	41.58
		0.025	4	2.70	0.00	3.85	10.80	41.58	1	41.58
		0.025	4	2.70	0.00	3.85	10.80	41.58	1	41.58
	Lap. atas	0.025	4	5.40	0.00	3.85	21.60	83.16	1	83.16
	Lap. bawah	0.025	2	8.10	0.25	3.85	16.70	64.30	1	64.30
		0.025	4	8.10	0.00	3.85	32.40	124.74	1	124.74
Susut	0.012	2	10.80	0.12	0.89	21.84	19.44	1	19.44	
<i>Jumlah</i>								459.88		459.88
BLb	Pokok	0.025	4	4.00	0.00	3.85	16.00	61.60	2	123.20
		0.025	4	4.00	0.00	3.85	16.00	61.60	2	123.20
	Susut	0.012	2	3.60	0.12	0.89	7.44	6.62	2	13.24
<i>Jumlah</i>								129.82		259.64

Type	Jenis	φ Besi (m)	Jumlah Tulangan	Panjang Tulangan (m)	Kait (m)	Berat Besi (kg/m)	Kebutuhan Besi (m)	Berat Tulangan (kg)	Jumlah Tipe Balok	Berat Total Tulangan (kg)	
a	b	c	d	e	$f=5 * c$	g	$h=(e+f)*d$	$i=g * h$	j	$k=i * j$	
ATAP											
1. As 7-8 (As D / As E), As 4-7 (As D/As E), As 8-11 (As D/As E)											
G1	Tump. atas	0.025	3	2.70	0.13	3.85	8.48	32.63	6	195.77	
		0.025	4	2.70	0.00	3.85	10.80	41.58	6	249.48	
		0.025	3	2.70	0.13	3.85	8.48	32.63	6	195.77	
		0.025	4	2.70	0.00	3.85	10.80	41.58	6	249.48	
	Tump. bawah	0.025	5	2.70	0.00	3.85	13.50	51.98	6	311.85	
		Lap. atas	0.025	4	5.40	0.00	3.85	21.60	83.16	6	498.96
		Lap. bawah	0.025	5	8.10	0.00	3.85	40.50	155.93	6	935.55
	Susut	0.010	2	10.80	0.10	0.62	21.80	13.52	6	81.10	
		0.012	4	10.80	0.12	0.89	43.68	38.88	6	233.25	
	<i>Jumlah</i>								491.87		2951.21
1. As E-F (As 7 / As 8) ; As D-E (As 7 / As 8)											
G1	Tump. atas	0.025	6	2.70	0.13	3.85	16.95	65.26	4	261.03	
		0.025	4	2.70	0.00	3.85	10.80	41.58	4	166.32	
		0.025	6	2.70	0.13	3.85	16.95	65.26	4	261.03	
		0.025	4	2.70	0.00	3.85	10.80	41.58	4	166.32	
	Tump. bawah	0.025	6	2.70	0.00	3.85	16.20	62.37	4	249.48	
		Lap. atas	0.025	4	5.40	0.00	3.85	21.60	83.16	4	332.64
		Lap. bawah	0.025	6	8.10	0.00	3.85	48.60	187.11	4	748.44
	Susut	0.010	2	10.80	0.10	0.62	21.80	13.52	4	54.06	
		0.012	4	10.80	0.12	0.89	43.68	38.88	4	155.50	
	<i>Jumlah</i>								598.71		2394.82
2. As B-D (As 7 / As 8)											
G2	Tump. atas	0.025	3	2.70	0.13	3.85	8.48	32.63	2	65.26	
		0.025	4	2.70	0.00	3.85	10.80	41.58	2	83.16	
		0.025	3	2.70	0.13	3.85	8.48	32.63	2	65.26	
		0.025	4	2.70	0.00	3.85	10.80	41.58	2	83.16	
	Tump. bawah	0.025	5	2.70	0.00	3.85	13.50	51.98	2	103.95	
		Lap. atas	0.025	4	5.40	0.00	3.85	21.60	83.16	2	166.32
		Lap. bawah	0.025	1	8.10	0.13	3.85	8.23	31.67	2	63.33
	Susut	0.025	5	8.10	0.00	3.85	40.50	155.93	2	311.85	
		0.010	2	10.80	0.10	0.62	21.80	13.52	2	27.03	
		0.012	4	10.80	0.12	0.89	43.68	38.88	2	77.75	
<i>Jumlah</i>								523.53		1047.07	
3. As D-E (As 4 / As 11) ; As 7-8 (As B)											
G3	Tump. atas	0.025	2	2.70	0.13	3.85	5.65	21.75	3	65.26	
		0.025	4	2.70	0.00	3.85	10.80	41.58	3	124.74	
		0.025	2	2.70	0.13	3.85	5.65	21.75	3	65.26	
		0.025	4	2.70	0.00	3.85	10.80	41.58	3	124.74	
	Tump. bawah	0.025	4	2.70	0.00	3.85	10.80	41.58	3	124.74	
		Lap. atas	0.025	4	5.40	0.00	3.85	21.60	83.16	3	249.48
		Lap. bawah	0.025	2	8.10	0.13	3.85	16.45	63.33	3	190.00
	Susut	0.025	4	8.10	0.00	3.85	32.40	124.74	3	374.22	
		0.010	2	10.80	0.10	0.62	21.80	13.52	3	40.55	
		0.012	4	10.80	0.12	0.89	43.68	38.88	3	116.63	
<i>Jumlah</i>								491.87		1475.61	

4a. As D-E (As 2 / As 13) ; As 7-8 (As A)										
G4	Tump. atas	0.025	1	3.20	0.13	3.85	3.33	12.80	3	38.40
		0.025	4	3.20	0.00	3.85	12.80	49.28	3	147.84
		0.025	1	3.20	0.13	3.85	3.33	12.80	3	38.40
		0.025	4	3.20	0.00	3.85	12.80	49.28	3	147.84
	Tump. bawah	0.025	4	3.70	0.00	3.85	14.80	56.98	3	170.94
		0.025	4	5.40	0.00	3.85	21.60	83.16	3	249.48
	Lap. atas	0.025	1	8.10	0.13	3.85	8.23	31.67	3	95.00
		0.025	4	8.10	0.00	3.85	32.40	124.74	3	374.22
	Susut	0.010	2	10.80	0.10	0.62	21.80	13.52	3	40.55
		0.012	4	10.80	0.12	0.89	43.68	38.88	3	116.63
<i>Jumlah</i>								473.10		1419.30
4b. As 2-4 (As D / As E) ; As 11-13 (As D / As E)										
G4	Tump. atas	0.025	2	1.80	0.13	3.85	3.85	14.82	4	59.29
		0.025	4	1.80	0.00	3.85	7.20	27.72	4	110.88
		0.025	2	2.60	0.13	3.85	5.45	20.98	4	83.93
		0.025	4	2.60	0.00	3.85	10.40	40.04	4	160.16
	Tump. bawah	0.025	4	3.50	0.00	3.85	14.00	53.90	4	215.60
		0.025	4	3.60	0.00	3.85	14.40	55.44	4	221.76
	Lap. atas	0.025	1	4.50	0.13	3.85	4.63	17.81	4	71.23
		0.025	4	4.50	0.00	3.85	18.00	69.30	4	277.20
	Susut	0.010	2	7.20	0.10	0.62	14.60	9.05	4	36.21
		0.012	4	7.20	0.12	0.89	29.28	26.06	4	104.24
<i>Jumlah</i>								335.12		1340.49
5. As 7-8 (As F / As K)										
G5	Tump. atas	0.025	2	2.70	0.13	3.85	5.65	21.75	2	43.51
		0.025	4	2.70	0.00	3.85	10.80	41.58	2	83.16
		0.025	2	2.70	0.13	3.85	5.65	21.75	2	43.51
		0.025	4	2.70	0.00	3.85	10.80	41.58	2	83.16
	Tump. bawah	0.025	4	2.00	0.00	3.85	8.00	30.80	2	61.60
		0.025	4	5.40	0.00	3.85	21.60	83.16	2	166.32
	Lap. atas	0.025	1	8.80	0.13	3.85	8.93	34.36	2	68.72
		0.025	4	8.80	0.00	3.85	35.20	135.52	2	271.04
	Susut	0.010	2	10.80	0.10	0.62	21.80	13.52	2	27.03
		0.012	4	10.80	0.12	0.89	43.68	38.88	2	77.75
<i>Jumlah</i>								462.90		925.79
5. As E-F (As 4 / As 11)										
G5	Tump. atas	0.025	2	3.50	0.13	3.85	7.25	27.91	2	55.83
		0.025	4	3.50	0.00	3.85	14.00	53.90	2	107.80
		0.025	2	2.70	0.13	3.85	5.65	21.75	2	43.51
		0.025	4	2.70	0.00	3.85	10.80	41.58	2	83.16
	Tump. bawah	0.025	4	3.50	0.00	3.85	14.00	53.90	2	107.80
		0.025	4	5.40	0.00	3.85	21.60	83.16	2	166.32
	Lap. atas	0.025	2	8.10	0.13	3.85	16.45	63.33	2	126.67
		0.025	4	8.10	0.00	3.85	32.40	124.74	2	249.48
	Susut	0.010	2	10.80	0.10	0.62	21.80	13.52	2	27.03
		0.012	4	10.80	0.12	0.89	43.68	38.88	2	77.75
<i>Jumlah</i>								522.67		1045.34
6. As C-D (As 4 / As 11)										
G6	Tump. atas	0.025	2	1.80	0.13	3.85	3.85	14.82	2	29.65
		0.025	4	1.80	0.00	3.85	7.20	27.72	2	55.44
		0.025	2	2.60	0.13	3.85	5.45	20.98	2	41.97
		0.025	4	2.60	0.00	3.85	10.40	40.04	2	80.08
	Tump. bawah	0.025	4	2.80	0.00	3.85	11.20	43.12	2	86.24
		0.025	4	3.60	0.00	3.85	14.40	55.44	2	110.88
	Lap. atas	0.025	2	5.20	0.13	3.85	10.65	41.00	2	82.01
		0.025	4	5.20	0.00	3.85	20.80	80.08	2	160.16
	Susut	0.010	2	7.20	0.10	0.62	14.60	9.05	2	18.10
		0.012	4	7.20	0.12	0.89	29.28	26.06	2	52.12
<i>Jumlah</i>								358.32		716.64

6. As 5-7 (As B) ; As 8-10 (As B)										
G6	Tump. atas	0.025	1	1.80	0.13	3.85	1.93	7.41	2	14.82
		0.025	4	1.80	0.00	3.85	7.20	27.72	2	55.44
		0.025	1	2.60	0.13	3.85	2.73	10.49	2	20.98
		0.025	4	2.60	0.00	3.85	10.40	40.04	2	80.08
	Tump. bawah	0.025	4	2.80	0.00	3.85	11.20	43.12	2	86.24
		0.025	4	3.60	0.00	3.85	14.40	55.44	2	110.88
	Lap. atas	0.025	4	3.60	0.00	3.85	14.40	55.44	2	110.88
		0.025	1	5.20	0.13	3.85	5.33	20.50	2	41.00
	Lap. bawah	0.025	4	5.20	0.00	3.85	20.80	80.08	2	160.16
		0.010	2	7.20	0.10	0.62	14.60	9.05	2	18.10
Susut	0.012	4	7.20	0.12	0.89	29.28	26.06	2	52.12	
	<i>Jumlah</i>							319.91		639.83
7. As 5-7 (As F) ; As 8-10 (As F)										
G7	Tump. atas	0.025	4	1.80	0.13	3.85	7.70	29.65	2	59.29
		0.025	2	1.80	0.13	3.85	3.85	14.82	2	29.65
		0.025	4	1.80	0.00	3.85	7.20	27.72	2	55.44
		0.025	4	2.00	0.00	3.85	8.00	30.80	2	61.60
	Tump. bawah	0.025	4	3.60	0.00	3.85	14.40	55.44	2	110.88
		0.025	1	5.20	0.13	3.85	5.33	20.50	2	41.00
	Lap. atas	0.025	4	5.20	0.00	3.85	20.80	80.08	2	160.16
		0.025	4	5.20	0.00	3.85	20.80	80.08	2	160.16
	Lap. bawah	0.010	2	7.20	0.10	0.62	14.60	9.05	2	18.10
		0.012	4	7.20	0.12	0.89	29.28	26.06	2	52.12
<i>Jumlah</i>							294.12		588.24	
8. As F-K (As 7 / As 8)										
G8	Tump. atas	0.025	3	2.70	0.13	3.85	8.48	32.63	2	65.26
		0.025	4	2.70	0.00	3.85	10.80	41.58	2	83.16
		0.025	3	2.70	0.13	3.85	8.48	32.63	2	65.26
		0.025	4	2.70	0.00	3.85	10.80	41.58	2	83.16
	Tump. bawah	0.025	5	2.70	0.00	3.85	13.50	51.98	2	103.95
		0.025	4	5.40	0.00	3.85	21.60	83.16	2	166.32
	Lap. atas	0.025	1	8.10	0.13	3.85	8.23	31.67	2	63.33
		0.025	5	8.10	0.00	3.85	40.50	155.93	2	311.85
	Lap. bawah	0.010	2	10.80	0.10	0.62	21.80	13.52	2	27.03
		0.012	4	10.80	0.12	0.89	43.68	38.88	2	77.75
<i>Jumlah</i>							523.53		1047.07	
9. As 4-5 (As H / As I), As 10-11 (As H / As I), As 4-5 (As C), As 10-11 (As C), As B-C (As 5/As10) As F-H (As 5/As10), As A-B (As 7 / As 8), As 4-5 (As F), As 10-11 (As F)										
G9	Tump. atas	0.025	1	1.80	0.13	3.85	1.93	7.41	14	103.76
		0.025	4	1.80	0.00	3.85	7.20	27.72	14	388.08
		0.025	1	1.80	0.13	3.85	1.93	7.41	14	103.76
		0.025	4	1.80	0.00	3.85	7.20	27.72	14	388.08
	Tump. bawah	0.025	5	3.60	0.00	3.85	18.00	69.30	14	970.20
		0.025	4	1.60	0.00	3.85	6.40	24.64	14	344.96
	Lap. atas	0.025	5	1.60	0.00	3.85	8.00	30.80	14	431.20
		0.010	2	3.60	0.10	0.62	7.40	4.59	14	64.23
	Lap. bawah	0.012	4	3.60	0.12	0.89	14.88	13.24	14	185.40
		<i>Jumlah</i>							212.83	
10. As K-L (As 7 / As 8)										
G10	Pokok	0.025	4	4.40	0.00	3.85	17.60	67.76	2	135.52
		0.025	4	4.40	0.00	3.85	17.60	67.76	2	135.52
	Susut	0.010	2	3.60	0.10	0.62	7.40	4.59	2	9.18
		0.012	4	3.60	0.12	0.89	14.88	13.24	2	26.49
<i>Jumlah</i>							153.35		306.70	
10. As I-K (As 5/As 10) ; As K-L (As 6/As 9) ; As 5-6 (As K) ; As 9-10 (As K) ; As 6-7 (As I) ; As 8-9 (As I)										
G10	Tump. atas	0.025	1	1.80	0.13	3.85	1.93	7.41	8	59.29
		0.025	4	1.80	0.00	3.85	7.20	27.72	8	221.76
		0.025	1	1.80	0.13	3.85	1.93	7.41	8	59.29
		0.025	4	1.80	0.00	3.85	7.20	27.72	8	221.76
	Tump. bawah	0.025	5	3.60	0.00	3.85	18.00	69.30	8	554.40
		0.025	4	1.60	0.00	3.85	6.40	24.64	8	197.12
	Lap. atas	0.025	5	1.60	0.00	3.85	8.00	30.80	8	246.40
		0.010	2	3.60	0.10	0.62	7.40	4.59	8	36.70
	Lap. bawah	0.012	4	3.60	0.12	0.89	14.88	13.24	8	105.95
		<i>Jumlah</i>							212.83	

II, As 3-4 (As II / As I) ; As 11-12 (As II / As I)											
G11	Tump. atas	0.025	4	2.15	0.00	3.85	8.60	33.11	4	132.44	
		0.025	4	1.35	0.00	3.85	5.40	20.79	4	83.16	
	Tump. bawah	0.025	4	2.80	0.00	3.85	11.20	43.12	4	172.48	
		Lap. atas	0.025	4	2.57	0.00	3.85	10.28	39.58	4	158.31
	Lap. bawah	0.025	4	3.27	0.00	3.85	13.08	50.36	4	201.43	
	Susut	0.010	2	5.27	0.10	0.62	10.74	6.66	4	26.64	
		0.012	4	5.27	0.12	0.89	21.56	19.19	4	76.75	
<i>Jumlah</i>								212.80		851.21	
G13	Tump. atas	0.025	2	1.80	0.13	3.85	3.85	14.82	6	88.94	
		0.025	4	1.80	0.00	3.85	7.20	27.72	6	166.32	
		0.025	3	1.80	0.13	3.85	5.78	22.23	6	133.40	
		0.025	4	1.80	0.00	3.85	7.20	27.72	6	166.32	
	Tump. bawah	0.025	5	2.00	0.00	3.85	10.00	38.50	6	231.00	
	Lap. atas	0.025	4	3.60	0.00	3.85	14.40	55.44	6	332.64	
	Lap. bawah	0.025	5	5.20	0.00	3.85	26.00	100.10	6	600.60	
	Susut	0.012	2	7.20	0.12	0.89	14.64	13.03	6	78.18	
	<i>Jumlah</i>								299.57		1797.40
	G14	Tump. atas	0.025	2	1.80	0.13	3.85	3.85	14.82	2	29.65
0.025			5	1.80	0.00	3.85	9.00	34.65	2	69.30	
0.025			2	1.00	0.13	3.85	2.25	8.66	2	17.33	
0.025			5	1.00	0.00	3.85	5.00	19.25	2	38.50	
Tump. bawah		0.025	5	2.80	0.00	3.85	14.00	53.90	2	107.80	
Lap. atas		0.025	5	1.60	0.00	3.85	8.00	30.80	2	61.60	
Lap. bawah		0.025	5	1.60	0.00	3.85	8.00	30.80	2	61.60	
Susut		0.012	2	3.60	0.12	0.89	7.44	6.62	2	13.24	
<i>Jumlah</i>								199.51		399.01	
G15		Tump. atas	0.025	2	1.80	0.13	3.85	3.85	14.82	12	177.87
	0.025		4	1.80	0.00	3.85	7.20	27.72	12	332.64	
	0.025		2	1.00	0.13	3.85	2.25	8.66	12	103.95	
	0.025		4	1.00	0.00	3.85	4.00	15.40	12	184.80	
	Tump. bawah	0.025	5	2.80	0.00	3.85	14.00	53.90	12	646.80	
	Lap. atas	0.025	4	1.60	0.00	3.85	6.40	24.64	12	295.68	
	Lap. bawah	0.025	5	1.60	0.00	3.85	8.00	30.80	12	369.60	
	Susut	0.012	2	3.60	0.12	0.89	7.44	6.62	12	79.46	
	<i>Jumlah</i>								182.57		2190.80
	B1	Tump. atas	0.025	2	2.70	0.13	3.85	5.65	21.75	28	609.07
0.025			4	2.70	0.00	3.85	10.80	41.58	28	1164.24	
0.025			2	2.70	0.13	3.85	5.65	21.75	28	609.07	
0.025			4	2.70	0.00	3.85	10.80	41.58	28	1164.24	
Tump. bawah		0.025	4	2.70	0.00	3.85	10.80	41.58	28	1164.24	
Lap. atas		0.025	4	5.40	0.00	3.85	21.60	83.16	28	2328.48	
Lap. bawah		0.025	2	8.10	0.25	3.85	16.70	64.30	28	1800.26	
		0.025	4	8.10	0.00	3.85	32.40	124.74	28	3492.72	
Susut		0.012	2	10.80	0.12	0.89	21.84	19.44	28	544.25	
<i>Jumlah</i>								459.88		12876.57	
B2	Tump. atas	0.025	1	2.70	0.13	3.85	2.83	10.88	2	21.75	
		0.025	3	2.70	0.00	3.85	8.10	31.19	2	62.37	
		0.025	1	2.70	0.13	3.85	2.83	10.88	2	21.75	
		0.025	3	2.70	0.00	3.85	8.10	31.19	2	62.37	
	Tump. bawah	0.025	3	2.70	0.00	3.85	8.10	31.19	2	62.37	
	Lap. atas	0.025	3	5.40	0.00	3.85	16.20	62.37	2	124.74	
	Lap. bawah	0.025	1	8.10	0.25	3.85	8.35	32.15	2	64.30	
		0.025	3	8.10	0.00	3.85	24.30	93.56	2	187.11	
	Susut	0.012	2	10.80	0.12	0.89	21.84	19.44	2	38.88	
	<i>Jumlah</i>								322.82		645.64

B3a	Tump. atas	0.025	1	2.70	0.13	3.85	2.83	10.88	6	65.26
		0.025	3	2.70	0.00	3.85	8.10	31.19	6	187.11
		0.025	1	2.70	0.13	3.85	2.83	10.88	6	65.26
		0.025	3	2.70	0.00	3.85	8.10	31.19	6	187.11
	Tump. bawah	0.025	3	2.70	0.00	3.85	8.10	31.19	6	187.11
		0.025	3	5.40	0.00	3.85	16.20	62.37	6	374.22
	Lap. atas	0.025	1	8.10	0.25	3.85	8.35	32.15	6	192.89
	Lap. bawah	0.025	3	8.10	0.00	3.85	24.30	93.56	6	561.33
Susut	0.012	2	10.80	0.12	0.89	21.84	19.44	6	116.63	
<i>Jumlah</i>								322.82		1936.91
B3b	Tump. atas	0.025	1	2.20	0.13	3.85	2.33	8.95	16	143.22
		0.025	3	2.20	0.00	3.85	6.60	25.41	16	406.56
		0.025	1	2.20	0.13	3.85	2.33	8.95	16	143.22
		0.025	3	2.20	0.00	3.85	6.60	25.41	16	406.56
	Tump. bawah	0.025	3	2.80	0.00	3.85	8.40	32.34	16	517.44
		0.025	3	3.60	0.00	3.85	10.80	41.58	16	665.28
	Lap. atas	0.025	1	5.20	0.25	3.85	5.45	20.98	16	335.72
	Lap. bawah	0.025	3	5.20	0.00	3.85	15.60	60.06	16	960.96
Susut	0.012	2	7.20	0.12	0.89	14.64	13.03	16	208.47	
<i>Jumlah</i>								326.71		3787.43
B4	Tump. atas	0.025	2	2.20	0.13	3.85	4.65	17.90	4	71.61
		0.025	4	2.20	0.00	3.85	8.80	33.88	4	135.52
		0.025	2	1.80	0.13	3.85	3.85	14.82	4	59.29
		0.025	4	1.80	0.00	3.85	7.20	27.72	4	110.88
	Tump. bawah	0.025	4	2.40	0.00	3.85	9.60	36.96	4	147.84
		0.025	4	3.60	0.00	3.85	14.40	55.44	4	221.76
	Lap. atas	0.025	2	5.20	0.25	3.85	10.90	41.97	4	167.86
	Lap. bawah	0.025	4	5.20	0.00	3.85	20.80	80.08	4	320.32
Susut	0.012	2	7.20	0.12	0.89	14.64	13.03	4	52.12	
<i>Jumlah</i>								321.80		1287.20
B5	Pokok	0.025	3	4.00	0.00	3.85	12.00	46.20	12	554.40
		0.025	3	4.00	0.00	3.85	12.00	46.20	12	554.40
	Susut	0.012	2	3.60	0.06	0.89	7.32	6.51	12	78.18
<i>Jumlah</i>								98.91		1186.98

Perhitungan Kebutuhan Besi Tulangan Begel Balok Lantai

Type	Panjang balok (m)	Lebar 1 (m)	Tinggi 1 (m)	Lebar 2 (m)	Tinggi 2 (m)	ε besi (m)	Keliling Balok 1 (m)	Keliling Balok 2 (m)	Selimut Beton 5cm (m)	Kait 10 D (m)	Jarak antar Begel 1 (m)	Jarak antar Begel 2 (m)	Berat Besi (kg/m)	Panjang Begel 1 (m)	Panjang Begel 2 (m)	Jumlah Begel 1	Jumlah Begel 2	Berat Begel (kg)	
a	b	c	d	e	f	g	$h=(2*c)+ (2*d)$	$i=(2*e)+ (2*f)$	$j=4*0.05$	$k=2*10$	l	m	n	$o=h+j+k$	$p=i+j+k$	$q=(b/l)+ 1$	$r=(b/m)+ 1$	$s1=n*o*q$	$s2=n*p*r$
LANTAI 2																			
G1	10.05	0.65	0.50	-	-	0.006	2.30	-	0.20	0.12	0.25	-	0.22	2.22	-	41	-	20.12	
	3.60	-	-	0.45	0.90	0.010	-	2.70	0.20	0.20	-	0.10	0.62	-	5.40	-	37	123.88	
	6.45	-	-	0.45	0.90	0.010	-	2.70	0.20	0.20	-	0.15	0.62	-	2.70	-	44	73.66	
G2	10.05	0.65	0.50	-	-	0.006	2.30	-	0.20	0.12	0.25	-	0.22	2.22	-	<i>Jumlah</i>		217.66	
	3.60	-	-	0.45	0.90	0.010	-	2.70	0.20	0.20	-	0.10	0.62	-	5.40	-	41	20.12	
	6.45	-	-	0.45	0.90	0.010	-	2.70	0.20	0.20	-	0.15	0.62	-	2.70	-	44	123.88	
G3	10.15	0.65	0.50	-	-	0.006	2.30	-	0.20	0.12	0.25	-	0.22	2.22	-	<i>Jumlah</i>		217.66	
	3.60	-	-	0.45	0.90	0.010	-	2.70	0.20	0.20	-	0.10	0.62	-	5.40	-	42	20.32	
	6.55	-	-	0.45	0.90	0.010	-	2.70	0.20	0.20	-	0.15	0.62	-	2.70	-	45	123.88	
G4a	10.15	0.65	0.50	-	-	0.006	2.30	-	0.20	0.12	0.25	-	0.22	2.22	-	<i>Jumlah</i>		218.97	
	3.60	-	-	0.45	0.90	0.010	-	2.70	0.20	0.20	-	0.10	0.62	-	5.40	-	42	20.32	
	6.55	-	-	0.45	0.90	0.010	-	2.70	0.20	0.20	-	0.15	0.62	-	2.70	-	45	123.88	
G4b	6.55	0.65	0.50	-	-	0.006	2.30	-	0.20	0.12	0.25	-	0.22	2.22	-	<i>Jumlah</i>		218.97	
	3.60	-	-	0.45	0.90	0.010	-	2.70	0.20	0.20	-	0.10	0.62	-	5.40	-	27	13.28	
	2.95	-	-	0.45	0.90	0.010	-	2.70	0.20	0.20	-	0.15	0.62	-	2.70	-	21	123.88	
G5	10.15	0.65	0.50	-	-	0.006	2.30	-	0.20	0.12	0.25	-	0.22	2.22	-	<i>Jumlah</i>		171.76	
	3.60	-	-	0.45	0.90	0.010	-	2.70	0.20	0.20	-	0.10	0.62	-	5.40	-	42	20.32	
	6.55	-	-	0.45	0.90	0.010	-	2.70	0.20	0.20	-	0.15	0.62	-	2.70	-	45	123.88	
G6	6.55	0.65	0.50	-	-	0.006	2.30	-	0.20	0.12	0.25	-	0.22	2.22	-	<i>Jumlah</i>		218.97	
	3.60	-	-	0.45	0.90	0.010	-	2.70	0.20	0.20	-	0.10	0.62	-	5.40	-	27	13.28	
	2.95	-	-	0.45	0.90	0.010	-	2.70	0.20	0.20	-	0.15	0.62	-	2.70	-	21	123.88	
																<i>Jumlah</i>		171.76	

G7	6.50	0.65	0.50	-	-	0.006	2.30	-	0.20	0.12	0.25	-	0.22	2.22	-	27	-	15.19
	3.60	-	-	0.45	0.90	0.010	-	2.70	0.20	0.20	-	0.10	0.62	-	5.40	-	37	123.88
	2.90	-	-	0.45	0.90	0.010	-	2.70	0.20	0.20	-	0.15	0.62	-	2.70	-	20	34.04
																<i>Jumlah</i>		171.10
G8	10.10	0.65	0.50	-	-	0.006	2.30	-	0.20	0.12	0.25	-	0.22	2.22	-	41	-	20.22
	3.60	-	-	0.45	0.90	0.010	-	2.70	0.20	0.20	-	0.10	0.62	-	5.40	-	37	123.88
	6.50	-	-	0.45	0.90	0.010	-	2.70	0.20	0.20	-	0.15	0.62	-	2.70	-	44	74.21
																<i>Jumlah</i>		218.31
G9	2.95	0.65	0.50	-	-	0.006	2.30	-	0.20	0.12	0.25	-	0.22	2.22	-	13	-	6.25
	2.95	-	-	0.45	0.90	0.010	-	2.70	0.20	0.20	-	0.10	0.62	-	5.40	-	31	102.11
																<i>Jumlah</i>		108.37
G10	2.95	0.65	0.50	-	-	0.006	2.30	-	0.20	0.12	0.25	-	0.22	2.22	-	13	-	6.25
	2.95	-	-	0.45	0.90	0.010	-	2.70	0.20	0.20	-	0.10	0.62	-	5.40	-	31	102.11
																<i>Jumlah</i>		108.37
G11	4.62	0.65	0.50	-	-	0.006	2.30	-	0.20	0.12	0.25	-	0.22	2.22	-	19	-	9.51
	3.60	-	-	0.45	0.90	0.010	-	2.70	0.20	0.20	-	0.10	0.62	-	5.40	-	37	123.88
	1.02	-	-	0.45	0.90	0.010	-	2.70	0.20	0.20	-	0.15	0.62	-	2.70	-	8	13.06
																<i>Jumlah</i>		146.45
G12	2.95	0.65	0.50	-	-	0.006	2.30	-	0.20	0.12	0.25	-	0.22	2.22	-	13	-	6.25
	2.95	-	-	0.45	0.90	0.010	-	2.70	0.20	0.20	-	0.10	0.62	-	5.40	-	31	102.11
																<i>Jumlah</i>		108.37

Type Balok	Lebar Balok (m)	Tinggi Balok (m)	Panjang Balok (m)	Ø Besi (m)	Keliling Balok (m)	Selimut Beton 5cm (m)	Kait 10 D (m)	Jarak antar Begel (m)	Berat Besi (kg/m)	Panjang 1 bh Begel (m)	Jumlah Begel	Berat Begel (kg)	Jumlah Tipe Sloof	Berat Total Begel (kg)	
a	b	c	d	e	$f = (2*b) + (2*c)$	$g = 4*0.05$	$h = 2*10*e$	i	j	$k = f-g+h$	$l = (d/i)+1$	$m = j*k*l$	n	$o = m*n$	
<i>Begel balok anak lantai 2</i>															
G13	0.4	0.7	3.60	0.01	2.2	0.2	0.2	0.10	0.62	2.20	37	50.47	6	302.81	
	0.4	0.7	2.95	0.01	2.2	0.2	0.2	0.15	0.62	2.20	21	28.19	6	169.14	
G14	0.4	0.7	3.60	0.01	2.2	0.2	0.2	0.10	0.62	2.20	37	50.47	2	100.94	
	0.4	0.7	1.90	0.01	2.2	0.2	0.2	0.15	0.62	2.20	14	18.64	2	37.28	
G15	0.4	0.7	2.00	0.01	2.2	0.2	0.2	0.10	0.62	2.20	21	28.64	12	343.73	
	0.4	0.7	1.40	0.01	2.2	0.2	0.2	0.15	0.62	2.20	10	14.09	12	169.14	
B1	0.4	0.5	5.40	0.01	1.8	0.2	0.2	0.10	0.62	1.80	55	61.38	32	1964.16	
	0.4	0.5	4.75	0.01	1.8	0.2	0.2	0.15	0.62	1.80	33	36.46	32	1166.59	
B2	0.4	0.5	5.40	0.01	1.8	0.2	0.2	0.10	0.62	1.80	55	61.38	2	122.76	
	0.4	0.5	4.75	0.01	1.8	0.2	0.2	0.15	0.62	1.80	33	36.46	2	72.91	
B3	0.4	0.5	3.60	0.01	1.8	0.2	0.2	0.10	0.62	1.80	37	41.29	16	660.67	
	0.4	0.5	2.95	0.01	1.8	0.2	0.2	0.15	0.62	1.80	21	23.06	16	369.02	
B4	0.4	0.5	3.60	0.01	1.8	0.2	0.2	0.10	0.62	1.80	37	41.29	4	165.17	
	0.4	0.5	2.95	0.01	1.8	0.2	0.2	0.15	0.62	1.80	21	23.06	4	92.26	
B5	0.4	0.5	0.95	0.01	1.8	0.2	0.2	0.10	0.62	1.80	11	11.72	8	93.74	
	0.4	0.5	2.00	0.01	1.8	0.2	0.2	0.15	0.62	1.80	14	16.00	8	127.97	

G6	6.55	0.65	0.50	-	-	0.006	2.30	-	0.20	0.12	0.25	-	0.22	2.22	-	27	-	13.28
	3.60	-	-	0.45	0.90	0.010	-	2.70	0.20	0.20	-	0.10	0.62	-	5.40	-	37	123.88
	2.95	-	-	0.45	0.90	0.010	-	2.70	0.20	0.20	-	0.15	0.62	-	2.70	-	21	34.60
																<i>Jumlah</i>		171.76
G7	6.50	0.65	0.50	-	-	0.006	2.30	-	0.20	0.12	0.25	-	0.22	2.22	-	27	-	13.19
	3.60	-	-	0.45	0.90	0.010	-	2.70	0.20	0.20	-	0.10	0.62	-	5.40	-	37	123.88
	2.90	-	-	0.45	0.90	0.010	-	2.70	0.20	0.20	-	0.15	0.62	-	2.70	-	20	34.04
																<i>Jumlah</i>		171.10
G8	10.10	0.65	0.50	-	-	0.006	2.30	-	0.20	0.12	0.25	-	0.22	2.22	-	41	-	20.22
	3.60	-	-	0.45	0.90	0.010	-	2.70	0.20	0.20	-	0.10	0.62	-	5.40	-	37	123.88
	6.50	-	-	0.45	0.90	0.010	-	2.70	0.20	0.20	-	0.15	0.62	-	2.70	-	44	74.21
																<i>Jumlah</i>		218.31
G9	2.95	0.65	0.50	-	-	0.006	2.30	-	0.20	0.12	0.25	-	0.22	2.22	-	13	-	6.25
	2.95	-	-	0.45	0.90	0.010	-	2.70	0.20	0.20	-	0.10	0.62	-	5.40	-	31	102.11
																<i>Jumlah</i>		108.37
G10	2.95	0.65	0.50	-	-	0.006	2.30	-	0.20	0.12	0.25	-	0.22	2.22	-	13	-	6.25
	2.95	-	-	0.45	0.90	0.010	-	2.70	0.20	0.20	-	0.10	0.62	-	5.40	-	31	102.11
																<i>Jumlah</i>		108.37
G11	4.62	0.65	0.50	-	-	0.006	2.30	-	0.20	0.12	0.25	-	0.22	2.22	-	19	-	9.51
	3.60	-	-	0.45	0.90	0.010	-	2.70	0.20	0.20	-	0.10	0.62	-	5.40	-	37	123.88
	1.02	-	-	0.45	0.90	0.010	-	2.70	0.20	0.20	-	0.15	0.62	-	2.70	-	8	13.06
																<i>Jumlah</i>		146.45
G12	2.95	0.65	0.50	-	-	0.006	2.30	-	0.20	0.12	0.25	-	0.22	2.22	-	13	-	6.25
	2.95	-	-	0.45	0.90	0.010	-	2.70	0.20	0.20	-	0.10	0.62	-	5.40	-	31	102.11
																<i>Jumlah</i>		108.37

Type	Lebar Balok (m)	Tinggi Balok (m)	Panjang Balok (m)	Ø Besi (m)	Keliling Balok (m)	Selimut Beton 5cm (m)	Kait 10 D (m)	Jarak antar Begel (m)	Berat Besi (kg/m)	Panjang 1 bh Begel (m)	Jumlah Begel	Berat Begel (kg)	Jumlah Tipe Sloof	Berat Total Begel (kg)
a	b	c	d	e	$f = (2*b) + (2*c)$	$g = 4*0.04$	$h = 2*10*e$	i	j	$k = f-g+h$	$l = (df/l)+1$	$m = j*k*$	n	$o = m*n$
<i>Begal balok anak lantai 3</i>														
G13	0.4	0.7	3.60	0.01	2.2	0.2	0.2	0.10	0.62	2.20	37	50.47	6	302.81
	0.4	0.7	2.95	0.01	2.2	0.2	0.2	0.15	0.62	2.20	21	28.19	6	169.14
G14	0.4	0.7	3.60	0.01	2.2	0.2	0.2	0.10	0.62	2.20	37	50.47	2	100.94
	0.4	0.7	1.90	0.01	2.2	0.2	0.2	0.15	0.62	2.20	14	18.64	2	37.28
G15	0.4	0.7	2.00	0.01	2.2	0.2	0.2	0.10	0.62	2.20	21	28.64	12	343.73
	0.4	0.7	1.40	0.01	2.2	0.2	0.2	0.15	0.62	2.20	10	14.09	12	169.14
B1a	0.4	0.5	5.40	0.01	1.8	0.2	0.2	0.10	0.62	1.80	55	61.38	21	1288.98
	0.4	0.5	4.75	0.01	1.8	0.2	0.2	0.15	0.62	1.80	33	36.46	21	765.58
B1b	0.4	0.5	3.60	0.01	1.8	0.2	0.2	0.10	0.62	1.80	37	41.29	4	165.17
	0.4	0.5	3.08	0.01	1.8	0.2	0.2	0.15	0.62	1.80	22	24.03	4	96.12
B1c	0.4	0.5	0.95	0.01	1.8	0.2	0.2	0.10	0.62	1.80	11	11.72	2	23.44
	0.4	0.5	2.00	0.01	1.8	0.2	0.2	0.15	0.62	1.80	14	16.00	2	31.99
B2	0.4	0.5	5.40	0.01	1.8	0.2	0.2	0.10	0.62	1.80	55	61.38	2	122.76
	0.4	0.5	4.75	0.01	1.8	0.2	0.2	0.15	0.62	1.80	33	36.46	2	72.91
B3	0.4	0.5	3.60	0.01	1.8	0.2	0.2	0.10	0.62	1.80	37	41.29	16	660.67
	0.4	0.5	2.95	0.01	1.8	0.2	0.2	0.15	0.62	1.80	21	23.06	16	369.02
B4	0.4	0.5	3.60	0.01	1.8	0.2	0.2	0.10	0.62	1.80	37	41.29	6	247.75
	0.4	0.5	2.95	0.01	1.8	0.2	0.2	0.15	0.62	1.80	21	23.06	6	138.38
B5	0.4	0.5	0.95	0.01	1.8	0.2	0.2	0.10	0.62	1.80	11	11.72	10	117.18
	0.4	0.5	2.00	0.01	1.8	0.2	0.2	0.15	0.62	1.80	14	16.00	10	159.96
BL a	0.4	0.5	5.40	0.01	1.8	0.2	0.2	0.10	0.62	1.80	55	61.38	1	61.38
	0.4	0.5	4.75	0.01	1.8	0.2	0.2	0.15	0.62	1.80	33	36.46	1	36.46
BL b	0.4	0.5	2.00	0.01	1.8	0.2	0.2	0.10	0.62	1.80	21	23.44	2	46.87
	0.4	0.5	0.95	0.01	1.8	0.2	0.2	0.15	0.62	1.80	7	8.18	2	16.37

Type	Panjang Balok (m)	Lebar 1 (m)	Tinggi 1 (m)	Lebar 2 (m)	Tinggi 2 (m)	e besi (m)	Keliling Balok 1 (m)	Keliling Balok 2 (m)	Selimit Beton 5cm (m)	Kait 10 D (m)	Jarak antar Balok 1 (m)	Jarak antar Balok 2 (m)	Berat Besi (kg/m)	Panjang Begel 1 (m)	Panjang Begel 2 (m)	Jumlah Begel 1	Jumlah Begel 2	Berat Begel (kg)	
a	b	c	d	e	f	g	$h=(2*c)+ (2*d)$	$i=(2*e)+ (2*f)$	$j=4*0.05$	$k=2*10$	l	m	n	$o=h+j+k$	$p=i+j+k$	$q=(b/l)+ 1$	$r=(b/m)+ 1$	$s1=n*o*q$	$s2=n*p*r$
ATAP																			
G1	10.05	0.65	0.50	-	-	0.006	2.30	-	0.20	0.12	0.25	-	0.22	2.22	-	41	-	20.12	
	3.60	-	-	0.45	0.90	0.010	-	2.70	0.20	0.20	-	0.10	0.62	-	5.40	-	37	123.88	
	6.45	-	-	0.45	0.90	0.010	-	2.70	0.20	0.20	-	0.15	0.62	-	2.70	-	44	73.66	
																	<i>Jumlah</i>		217.66
G2	10.05	0.65	0.50	-	-	0.006	2.30	-	0.20	0.12	0.25	-	0.22	2.22	-	41	-	20.12	
	3.60	-	-	0.45	0.90	0.010	-	2.70	0.20	0.20	-	0.10	0.62	-	5.40	-	37	123.88	
	6.45	-	-	0.45	0.90	0.010	-	2.70	0.20	0.20	-	0.15	0.62	-	2.70	-	44	73.66	
																	<i>Jumlah</i>		217.66
G3	10.15	0.65	0.50	-	-	0.006	2.30	-	0.20	0.12	0.25	-	0.22	2.22	-	42	-	20.32	
	3.60	-	-	0.45	0.90	0.010	-	2.70	0.20	0.20	-	0.10	0.62	-	5.40	-	37	123.88	
	6.55	-	-	0.45	0.90	0.010	-	2.70	0.20	0.20	-	0.15	0.62	-	2.70	-	45	74.77	
																	<i>Jumlah</i>		218.97
G4a	10.15	0.65	0.50	-	-	0.006	2.30	-	0.20	0.12	0.25	-	0.22	2.22	-	42	-	20.32	
	3.60	-	-	0.45	0.90	0.010	-	2.70	0.20	0.20	-	0.10	0.62	-	5.40	-	37	123.88	
	6.55	-	-	0.45	0.90	0.010	-	2.70	0.20	0.20	-	0.15	0.62	-	2.70	-	45	74.77	
																	<i>Jumlah</i>		218.97
G4b	6.55	0.65	0.50	-	-	0.006	2.30	-	0.20	0.12	0.25	-	0.22	2.22	-	27	-	13.28	
	3.60	-	-	0.45	0.90	0.010	-	2.70	0.20	0.20	-	0.10	0.62	-	5.40	-	37	123.88	
	2.95	-	-	0.45	0.90	0.010	-	2.70	0.20	0.20	-	0.15	0.62	-	2.70	-	21	34.60	
																	<i>Jumlah</i>		171.76
G5	10.15	0.65	0.50	-	-	0.006	2.30	-	0.20	0.12	0.25	-	0.22	2.22	-	42	-	20.32	
	3.60	-	-	0.45	0.90	0.010	-	2.70	0.20	0.20	-	0.10	0.62	-	5.40	-	37	123.88	
	6.55	-	-	0.45	0.90	0.010	-	2.70	0.20	0.20	-	0.15	0.62	-	2.70	-	45	74.77	
																	<i>Jumlah</i>		218.97
G6	6.55	0.65	0.50	-	-	0.006	2.30	-	0.20	0.12	0.25	-	0.22	2.22	-	27	-	13.28	
	3.60	-	-	0.45	0.90	0.010	-	2.70	0.20	0.20	-	0.10	0.62	-	5.40	-	37	123.88	
	2.95	-	-	0.45	0.90	0.010	-	2.70	0.20	0.20	-	0.15	0.62	-	2.70	-	21	34.60	
																	<i>Jumlah</i>		171.76

G7	6.50	0.65	0.50	-	-	0.006	2.30	-	0.20	0.12	0.25	-	0.22	2.22	-	27	-	13.19
	3.60	-	-	0.45	0.90	0.010	-	2.70	0.20	0.20	-	-	0.62	-	5.40	-	37	123.88
	2.90	-	-	0.45	0.90	0.010	-	2.70	0.20	0.20	-	-	0.62	-	2.70	-	20	34.04
																<i>Jumlah</i>		171.10
G8	10.10	0.65	0.50	-	-	0.006	2.30	-	0.20	0.12	0.25	-	0.22	2.22	-	41	-	20.22
	3.60	-	-	0.45	0.90	0.010	-	2.70	0.20	0.20	-	-	0.62	-	5.40	-	37	123.88
	6.50	-	-	0.45	0.90	0.010	-	2.70	0.20	0.20	-	-	0.62	-	2.70	-	44	74.21
																<i>Jumlah</i>		218.31
G9	2.95	0.65	0.50	-	-	0.006	2.30	-	0.20	0.12	0.25	-	0.22	2.22	-	13	-	6.25
	2.95	-	-	0.45	0.90	0.010	-	2.70	0.20	0.20	-	-	0.62	-	5.40	-	31	102.11
																<i>Jumlah</i>		108.37
G10	2.95	0.65	0.50	-	-	0.006	2.30	-	0.20	0.12	0.25	-	0.22	2.22	-	13	-	6.25
	2.95	-	-	0.45	0.90	0.010	-	2.70	0.20	0.20	-	-	0.62	-	5.40	-	31	102.11
																<i>Jumlah</i>		108.37
G11	4.62	0.65	0.50	-	-	0.006	2.30	-	0.20	0.12	0.25	-	0.22	2.22	-	19	-	9.51
	3.60	-	-	0.45	0.90	0.010	-	2.70	0.20	0.20	-	-	0.62	-	5.40	-	37	123.88
	1.02	-	-	0.45	0.90	0.010	-	2.70	0.20	0.20	-	-	0.62	-	2.70	-	8	13.06
																<i>Jumlah</i>		146.45

Type	Lebar Balok (m)	Tinggi Balok (m)	Panjang Balok (m)	Ø Besi	Keliling Balok (m)	Selimut Beton 5cm (m)	Kait 10 D (m)	Jarak antar Begel (m)	Berat Besi (kg/m)	Panjang 1 bh Begel (m)	Jumlah Begel	Berat Begel (kg)	Jumlah Tipe Sloof	Berat Total Begel (kg)	
a	b	c	d	e	$f = (2*b) + (2*c)$	$g = 4*0.04$	$h = 2*10*e$	i	j	$k = f-g+h$	$l = (d/f)+1$	$m = j*k*l$	n	$o = m*n$	
<i>Begal balok anak lantai Atap</i>															
G13	0.4	0.7	3.60	0.01	2.2	0.2	0.2	0.10	0.62	2.20	37	50.47	6	302.81	
	0.4	0.7	2.95	0.01	2.2	0.2	0.2	0.15	0.62	2.20	21	28.19	6	169.14	
G14	0.4	0.7	3.60	0.01	2.2	0.2	0.2	0.10	0.62	2.20	37	50.47	2	100.94	
	0.4	0.7	1.90	0.01	2.2	0.2	0.2	0.15	0.62	2.20	14	18.64	2	37.28	
G15	0.4	0.7	2.00	0.01	2.2	0.2	0.2	0.10	0.62	2.20	21	28.64	12	343.73	
	0.4	0.7	1.40	0.01	2.2	0.2	0.2	0.15	0.62	2.20	10	14.09	12	169.14	
B1	0.4	0.5	5.40	0.01	1.8	0.2	0.2	0.10	0.62	1.80	55	61.38	28	1718.64	
	0.4	0.5	4.75	0.01	1.8	0.2	0.2	0.15	0.62	1.80	33	36.46	28	1020.77	
B2	0.4	0.5	5.40	0.01	1.8	0.2	0.2	0.10	0.62	1.80	55	61.38	2	122.76	
	0.4	0.5	4.75	0.01	1.8	0.2	0.2	0.15	0.62	1.80	33	36.46	2	72.91	
B3a	0.4	0.5	5.40	0.01	1.8	0.2	0.2	0.10	0.62	1.80	55	61.38	6	368.28	
	0.4	0.5	4.75	0.01	1.8	0.2	0.2	0.15	0.62	1.80	33	36.46	6	218.74	
B3b	0.4	0.5	3.60	0.01	1.8	0.2	0.2	0.10	0.62	1.80	37	41.29	16	660.67	
	0.4	0.5	2.95	0.01	1.8	0.2	0.2	0.15	0.62	1.80	21	23.06	16	369.02	
B4	0.4	0.5	3.60	0.01	1.8	0.2	0.2	0.10	0.62	1.80	37	41.29	4	165.17	
	0.4	0.5	2.95	0.01	1.8	0.2	0.2	0.15	0.62	1.80	21	23.06	4	92.26	
B5	0.4	0.5	0.95	0.01	1.8	0.2	0.2	0.10	0.62	1.80	11	11.72	12	140.62	
	0.4	0.5	2.00	0.01	1.8	0.2	0.2	0.15	0.62	1.80	14	16.00	12	191.95	

Rekapitulasi Kebutuhan Besi Tulangan Ulir Balok Lantai

No	Typ	ε Besi Ulir	Berat Total Tul. Ulir (kg)	Volume Beton (m ³)	Konversi Tul. dlm 1m ³ Beton (kg)	Besi Beton Ulir (koef bhnxbrt tul) (kg)	Bendrat (koef bhnxbrt tul) (kg)
a	b	c	d	e	$f = (1/e) * d$	$g = 1.10 * f$	$h = 0.02 * f$
BALOK LANTAI 2							
1	G 1	D 25	745.75	4.29	173.833	191.217	3.477
2	G 1	D 25	712.64	4.29	166.115	182.727	3.322
3	G 2	D 25	776.45	4.29	180.990	199.089	3.620
4	G 3	D 25	508.59	4.33	117.456	129.202	2.349
5	G 4a	D 25	589.05	4.33	136.039	149.643	2.721
6	G 4b	D 25	300.49	2.80	107.319	118.051	2.146
7	G 5	D 25	410.99	4.33	94.916	104.408	1.898
8	G 5	D 25	471.24	4.33	108.831	119.715	2.177
9	G 6	D 25	347.27	2.80	124.025	136.428	2.481
10	G 6	D 25	346.69	2.80	123.819	136.201	2.476
11	G 7	D 25	286.54	2.78	103.071	113.378	2.061
12	G 8	D 25	544.39	4.31	126.309	138.939	2.526
13	G 9	D 25	229.85	1.26	182.417	200.658	3.648
14	G 10	D 25	192.89	1.26	153.083	168.392	3.062
15	G 10	D 25	229.85	1.26	182.417	200.658	3.648
16	G 11	D 25	214.06	1.97	108.660	119.526	2.173
17	G 12	D 25	192.89	1.40	137.775	151.553	2.756
18	G 13	D 25	286.54	1.58	181.352	199.487	3.627
19	G 14	D 25	192.89	1.28	150.691	165.761	3.014
20	G 15	D 25	175.95	0.79	222.715	244.987	4.454
21	B 1	D 25	440.44	1.54	286.000	314.600	5.720
22	B 2	D 25	303.38	1.54	197.000	216.700	3.940
23	E 3	D 25	223.69	1.00	223.685	246.054	4.474
24	B 4	D 25	308.77	1.00	308.770	339.647	6.175
25	B 5	D 25	92.40	0.47	196.596	216.255	3.932
BALOK LANTAI 3							
1	G 1a	D 25	546.32	4.29	127.346	140.081	2.547
2	G 1a	D 25	524.56	4.29	122.276	134.503	2.446
3	G 1a	D 25	692.81	4.29	161.494	177.643	3.230
4	G 1b	D 25	276.24	1.44	191.832	211.015	3.837
5	G 2	D 25	381.34	2.85	133.804	147.185	2.676
6	G 2	D 25	414.36	2.85	145.388	159.927	2.908
7	G 3	D 25	523.60	4.33	120.924	133.016	2.418
8	G 4a	D 25	472.01	4.33	109.009	119.910	2.180
9	G 4b	D 25	337.45	2.80	120.519	132.571	2.410
10	G 5	D 25	459.21	4.33	106.053	116.658	2.121
11	G 5	D 25	524.18	4.33	121.057	133.163	2.421
12	G 6	D 25	362.67	2.80	129.525	142.478	2.591
13	G 6	D 25	345.73	2.80	123.475	135.823	2.470
14	G 7	D 25	286.54	2.78	103.071	113.378	2.061
15	G 8	D 25	471.63	4.31	109.426	120.368	2.189
16	G 9	D 25	229.85	1.26	182.417	200.658	3.648
17	G 10	D 25	135.52	1.26	107.556	118.311	2.151

18	G 10	D 25	229.85	1.26	182.417	200.658	3.648
19	G 11	D 25	186.96	1.97	94.902	104.392	1.898
20	G 12	D 25	192.89	1.40	137.775	151.553	2.756
21	G 13	D 25	286.54	1.58	181.352	199.487	3.627
22	G 14	D 25	192.89	1.28	150.691	165.761	3.014
23	G 15	D 25	175.95	0.79	222.715	244.987	4.454
24	B 1a	D 25	440.44	1.54	286.000	314.600	5.720
25	B 1b	D 25	293.37	1.01	290.465	319.512	5.809
26	B 1c	D 25	123.20	0.50	246.400	271.040	4.928
27	B 2	D 25	303.38	1.54	197.000	216.700	3.940
28	B 3	D 25	223.69	1.00	223.685	246.054	4.474
29	B 4	D 25	308.77	1.00	308.770	339.647	6.175
30	B 5	D 25	92.40	0.47	196.596	216.255	3.932
31	B 1a	D 25	440.44	1.95	225.867	248.453	4.517
32	B 1b	D 25	123.20	0.63	195.556	215.111	3.911
BALOK ATAP							
1	G 1	D 25	439.48	4.29	102.442	112.687	2.049
2	G 1	D 25	546.32	4.29	127.346	140.081	2.547
3	G 2	D 25	471.14	4.29	109.824	120.806	2.196
4	G 3	D 25	439.48	4.33	101.496	111.646	2.030
5	G 4a	D 25	420.71	4.33	97.161	106.878	1.943
6	G 4b	D 25	300.01	2.80	107.147	117.862	2.143
7	G 5	D 25	410.51	4.33	94.805	104.286	1.896
8	G 5	D 25	470.28	4.33	108.609	119.470	2.172
9	G 6	D 25	323.21	2.80	115.431	126.974	2.309
10	G 6	D 25	284.80	2.80	101.716	111.887	2.034
11	G 7	D 25	259.01	2.78	93.169	102.485	1.863
12	G 8	D 25	471.14	4.31	109.314	120.246	2.186
13	G 9	D 25	195.00	1.26	154.764	170.240	3.095
14	G 10	D 25	135.52	1.26	107.556	118.311	2.151
15	G 10	D 25	195.00	1.26	154.764	170.240	3.095
16	G 11	D 25	186.96	1.97	94.902	104.392	1.898
17	G 13	D 25	286.54	1.58	181.352	199.487	3.627
18	G 14	D 25	192.89	1.28	150.691	165.761	3.014
19	G 15	D 25	175.95	0.79	222.715	244.987	4.454
20	B 1	D 25	440.44	1.54	286.000	314.600	5.720
21	B 2	D 25	303.38	1.54	197.000	216.700	3.940
22	B 3a	D 25	303.38	1.54	197.000	216.700	3.940
23	B 3b	D 25	223.69	1.03	217.170	238.887	4.343
24	B 4	D 25	308.77	1.00	308.770	339.647	6.175
25	B 5	D 25	92.40	0.47	196.596	216.255	3.932

Catatan : Untuk berat total besi tulangan ulir di dapat dengan menjumlahkan berat besi tulangan pokok yaitu besi tulangan tumpuan dan lapangan yang mempunyai jenis besi ulir (D 25).

Rekapitulasi Kebutuhan Besi Tulangan Polos Balok Lantai

No	Tipe	ε Besi Polos	Berat Total Tul. Polos (kg)	Volume Beton (m ³)	Konversi Tul. dlm 1m ³ Beton (kg)	Besi Beton Polos (koef bhxbrt tul) (kg)	Bendrat (koef bhxbrt tul) (kg)
a	b	c	d	e	$f = (1/c) * d$	$g = 1.10 * f$	$h = 0.02 * f$
BALOK LANTAI 2							
1	G 1	P6;P10;P12	270.06	4.29	62.951	69.246	1.259
2	G 1	P6;P10;P12	270.06	4.29	62.951	69.246	1.259
3	G 2	P6;P10;P12	270.06	4.29	62.951	69.246	1.259
4	G 3	P6;P10;P12	271.37	4.33	62.672	68.939	1.253
5	G 4a	P6;P10;P12	271.37	4.33	62.672	68.939	1.253
6	G 4b	P6;P10;P12	206.87	2.80	73.882	81.270	1.478
7	G 5	P6;P10;P12	271.37	4.33	62.672	68.939	1.253
8	G 5	P6;P10;P12	271.37	4.33	62.672	68.939	1.253
9	G 6	P6;P10;P12	206.87	2.80	73.882	81.270	1.478
10	G 6	P6;P10;P12	206.87	2.80	73.882	81.270	1.478
11	G 7	P6;P10;P12	206.22	2.78	74.180	81.598	1.484
12	G 8	P6;P10;P12	270.71	4.31	62.810	69.091	1.256
13	G 9	P6;P10;P12	126.19	1.26	100.151	110.166	2.003
14	G 10	P6;P10;P12	126.19	1.26	100.151	110.166	2.003
15	G 10	P6;P10;P12	126.19	1.26	100.151	110.166	2.003
16	G 11	P6;P10;P12	172.30	1.97	87.462	96.208	1.749
17	G 12	P6;P10;P12	126.19	1.40	90.136	99.149	1.803
18	G 13	P10 ; P12	91.69	1.58	58.032	63.835	1.161
19	G 14	P10 ; P12	75.73	1.28	59.164	65.080	1.183
20	G 15	P10 ; P12	49.35	0.79	62.468	68.715	1.249
21	B 1	P10 ; P12	117.28	1.54	76.156	83.771	1.523
22	B 2	P10 ; P12	117.28	1.54	76.156	83.771	1.523
23	B 3	P10 ; P12	77.38	1.00	77.380	85.118	1.548
24	B 4	P10 ; P12	77.38	1.00	77.380	85.118	1.548
25	B 5	P10 ; P12	34.23	0.47	72.830	80.113	1.457
BALOK LANTAI 3							
1	G 1a	P6;P10;P12	270.06	4.29	62.951	69.246	1.259
2	G 1a	P6;P10;P12	270.06	4.29	62.951	69.246	1.259
3	G 1a	P6;P10;P12	270.06	4.29	62.951	69.246	1.259
4	G 1b	P6;P10;P12	108.81	1.44	75.563	83.119	1.511
5	G 2	P6;P10;P12	168.39	2.85	59.084	64.993	1.182
6	G 2	P6;P10;P12	168.39	2.85	59.084	64.993	1.182
7	G 3	P6;P10;P12	271.37	4.33	62.672	68.939	1.253
8	G 4a	P6;P10;P12	271.37	4.33	62.672	68.939	1.253
9	G 4b	P6;P10;P12	206.87	2.80	73.882	81.270	1.478
10	G 5	P6;P10;P12	271.37	4.33	62.672	68.939	1.253
11	G 5	P6;P10;P12	271.37	4.33	62.672	68.939	1.253
12	G 6	P6;P10;P12	206.87	2.80	73.882	81.270	1.478
13	G 6	P6;P10;P12	206.87	2.80	73.882	81.270	1.478
14	G 7	P6;P10;P12	206.22	2.78	74.180	81.598	1.484
15	G 8	P6;P10;P12	270.71	4.31	62.810	69.091	1.256
16	G 9	P6;P10;P12	126.19	1.26	100.151	110.166	2.003

17	G 10	P6;P10;P12	126.19	1.26	100.151	110.166	2.003
18	G 10	P6;P10;P12	126.19	1.26	100.151	110.166	2.003
19	G 11	P6;P10;P12	172.30	1.97	87.462	96.208	1.749
20	G 12	P6;P10;P12	126.19	1.40	90.136	99.149	1.803
21	G 13	P10 ; P12	91.69	1.58	58.032	63.835	1.161
22	G 14	P10 ; P12	75.73	1.28	59.164	65.080	1.183
23	G 15	P10 ; P12	49.35	0.79	62.468	68.715	1.249
24	B 1a	P10 ; P12	117.28	1.54	76.156	83.771	1.523
25	B 1b	P10 ; P12	78.35	1.01	77.574	85.332	1.551
26	B 1c	P10 ; P12	34.34	0.50	68.680	75.548	1.374
27	B 2	P10 ; P12	117.28	1.54	76.156	83.771	1.523
28	B 3	P10 ; P12	77.38	1.00	77.380	85.118	1.548
29	B 4	P10 ; P12	77.38	1.00	77.380	85.118	1.548
30	B 5	P10 ; P12	34.23	0.47	72.830	80.113	1.457
31	B La	P10 ; P12	117.28	1.95	60.144	66.158	1.203
32	B Lb	P10 ; P12	38.24	0.63	60.698	66.768	1.214

BALOK ATAP

1	G 1	P6;P10;P12	270.06	4.29	62.951	69.246	1.259
2	G 1.	P6;P10;P12	270.06	4.29	62.951	69.246	1.259
3	G 2	P6;P10;P12	270.06	4.29	62.951	69.246	1.259
4	G 3	P6;P10;P12	271.37	4.33	62.672	68.939	1.253
5	G 4a	P6;P10;P12	271.37	4.33	62.672	68.939	1.253
6	G 4b	P6;P10;P12	206.87	2.80	73.882	81.270	1.478
7	G 5	P6;P10;P12	271.37	4.33	62.672	68.939	1.253
8	G 5	P6;P10;P12	271.37	4.33	62.672	68.939	1.253
9	G 6	P6;P10;P12	206.87	2.80	73.882	81.270	1.478
10	G 6	P6;P10;P12	206.87	2.80	73.882	81.270	1.478
11	G 7	P6;P10;P12	206.22	2.78	74.180	81.598	1.484
12	G 8	P6;P10;P12	270.71	4.31	62.810	69.091	1.256
13	G 9	P6;P10;P12	126.19	1.26	100.151	110.166	2.003
14	G 10	P6;P10;P12	126.19	1.26	100.151	110.166	2.003
15	G 10	P6;P10;P12	126.19	1.26	100.151	110.166	2.003
16	G 11	P6;P10;P12	172.30	1.97	87.462	96.208	1.749
17	G 13	P10 ; P12	91.69	1.58	58.032	63.835	1.161
18	G 14	P10 ; P12	75.73	1.28	59.164	65.080	1.183
19	G 15	P10 ; P12	49.35	0.79	62.468	68.715	1.249
20	B 1	P10 ; P12	117.28	1.54	76.156	83.771	1.523
21	B 2	P10 ; P12	117.28	1.54	76.156	83.771	1.523
22	B 3a	P10 ; P12	117.28	1.54	76.156	83.771	1.523
23	B 3b	P10 ; P12	77.38	1.03	75.126	82.639	1.503
24	B 4	P10 ; P12	77.38	1.00	77.380	85.118	1.548
25	B 5	P10 ; P12	34.23	0.47	72.830	80.113	1.457

Catatan : Untuk berat total besi tulangan polos di dapat dengan menjumlahkan berat besi tulangan susut dan besi tulangan begel yang mempunyai jenis besi polos (P6,P10,P12).

**DAFTAR ANALISA HARGA SATUAN
PEKERJAAN BALOK**

No	Uraian	Volume	Sat.	Harga Satuan (Rp)	Analisa Harga Bahan (Rp)	Analisa Harga Upah (Rp)	Total Harga Analisa (Rp)
VII	PEKERJAAN BETON BALOK						
I	BALOK LANTAI 2						
1	BALOK G1 (65/90)						
	BAHAN						
	Paku	1.04	kg	6,000.00	6,216.00		
	Besi ulir	192.20	kg	3,350.00	643,883.40		
	Besi polos	69.25	kg	3,000.00	207,738.00		
	Multipleks 15 mm (33,333%)	1.98	lbr	60,000.00	39,575.60		
	Beton Ready Mix <i>fc' 25 Mpa</i>	1.00	m ³	274,000.00	274,000.00		
	Kayu Bekisting (33,333%)	0.07	m ³	1,700,000.00	40,799.59		
	Bendrat	4.75	kg	6,500.00	30,901.00		
	Minyak bekisting	1.04	ltr	12,500.00	12,950.00		1.256.063.60
	UPAH BORONGAN						
	Cor ready mix dengan pompa	1.00	m ³	9,250.00		9,250.00	
	Buat + stel besi	261.45	kg	215.00		56,211.75	
	Bekisting	5.18	m ²	10,850.00		56,203.00	
	Pompa	1.00	m ³	8,000.00		8,000.00	
	Pasang + bongkar scaffolding	5.18	m ²	2,500.00		12,950.00	
	Scaffolding	3.00	set	19,500.00		58,500.00	201.114.75
					Jumlah		1.457.178.35
					Dibulatkan		1.457.178.00
2	BALOK G1 (65/90)						
	BAHAN						
	Paku	1.04	kg	6,000.00	6,216.00		
	Besi ulir	182.73	kg	3,350.00	612,135.45		
	Besi polos	69.25	kg	3,000.00	207,738.00		
	Multipleks 15 mm (33,333%)	1.98	lbr	60,000.00	39,575.60		
	Beton Ready Mix <i>fc' 25 Mpa</i>	1.00	m ³	274,000.00	274,000.00		
	Kayu Bekisting (33,333%)	0.07	m ³	1,700,000.00	40,799.59		
	Bendrat	4.58	kg	6,500.00	29,776.50		
	Minyak bekisting	1.04	ltr	12,500.00	12,950.00		1.223.191.15
	UPAH BORONGAN						
	Cor ready mix dengan pompa	1.00	m ³	9,250.00		9,250.00	
	Buat + stel besi	251.97	kg	215.00		54,174.20	
	Bekisting	5.18	m ²	10,850.00		56,203.00	
	Pompa	1.00	m ³	8,000.00		8,000.00	
	Pasang + bongkar scaffolding	5.18	m ²	2,500.00		12,950.00	
	Scaffolding	3.00	set	19,500.00		58,500.00	199.077.20
					Jumlah		1.422.268.34
					Dibulatkan		1.422.268.00
3	BALOK G2 (65/90)						
	BAHAN						
	Paku	1.04	kg	6,000.00	6,216.00		
	Besi ulir	199.09	kg	3,350.00	666,948.15		
	Besi polos	69.25	kg	3,000.00	207,738.00		
	Multipleks 15 mm (33,333%)	1.98	lbr	60,000.00	39,575.60		
	Beton Ready Mix <i>fc' 25 Mpa</i>	1.00	m ³	274,000.00	274,000.00		
	Kayu Bekisting (33,333%)	0.07	m ³	1,700,000.00	40,799.59		
	Bendrat	4.88	kg	6,500.00	31,713.50		
	Minyak bekisting	1.04	ltr	12,500.00	12,950.00		1.279.940.85
	UPAH BORONGAN						
	Cor ready mix dengan pompa	1.00	m ³	9,250.00		9,250.00	
	Buat + stel besi	268.34	kg	215.00		57,692.03	
	Bekisting	5.18	m ²	10,850.00		56,203.00	
	Pompa	1.00	m ³	8,000.00		8,000.00	
	Pasang + bongkar scaffolding	5.18	m ²	2,500.00		12,950.00	
	Scaffolding	3.00	set	19,500.00		58,500.00	202.595.03
					Jumlah		1.482.535.87
					Dibulatkan		1.482.536.00

4	BALOK G3 (65/90)								
	BAHAN								
	Paku	1.04	kg	6,000.00	6,216.00				
	Besi ulir	129.20	kg	3,350.00	432,826.70				
	Besi polos	68.94	kg	3,000.00	206,817.00				
	Multipleks 15 mm (33,333%)	1.98	lbr	60,000.00	39,575.60				
	Beton Ready Mix <i>fc' 25 Mpa</i>	1.00	m ³	274,000.00	274,000.00				
	Kayu Bekisting (33,333%)	0.07	m ³	1,700,000.00	40,799.59				
	Bendrat	3.60	kg	6,500.00	23,413.00				
	Minyak bekisting	1.04	ltr	12,500.00	12,950.00				1.036.597.90
	UPAH BORONGAN								
	Cor ready mix dengan pompa	1.00	m ³	9,250.00		9,250.00			
	Buat + stel besi	198.14	kg	215.00		42,600.32			
	Bekisting	5.18	m ²	10,850.00		56,203.00			
	Pompa	1.00	m ³	8,000.00		8,000.00			
	Pasang + bongkar scaffolding	5.18	m ²	2,500.00		12,950.00			
	Scaffolding	3.00	set	19,500.00		58,500.00			187,503.32
								Jumlah	1,224,101.21
								Dibulatkan	1,224,101.00
5	BALOK G4a (65/90)								
	BAHAN								
	Paku	1.04	kg	6,000.00	6,216.00				
	Besi ulir	149.64	kg	3,350.00	501,304.05				
	Besi polos	68.94	kg	3,000.00	206,817.00				
	Multipleks 15 mm (33,333%)	1.98	lbr	60,000.00	39,575.60				
	Beton Ready Mix <i>fc' 25 Mpa</i>	1.00	m ³	274,000.00	274,000.00				
	Kayu Bekisting (33,333%)	0.07	m ³	1,700,000.00	40,799.59				
	Bendrat	3.97	kg	6,500.00	25,831.00				
	Minyak bekisting	1.04	ltr	12,500.00	12,950.00				1.107.193.25
	UPAH BORONGAN								
	Cor ready mix dengan pompa	1.00	m ³	9,250.00		9,250.00			
	Buat + stel besi	218.58	kg	215.00		46,995.13			
	Bekisting	5.18	m ²	10,850.00		56,203.00			
	Pompa	1.00	m ³	8,000.00		8,000.00			
	Pasang + bongkar scaffolding	5.18	m ²	2,500.00		12,950.00			
	Scaffolding	3.00	set	19,500.00		58,500.00			191,898.13
								Jumlah	1,299,391.38
								Dibulatkan	1,299,391.00
6	BALOK G4b (65/90)								
	BAHAN								
	Paku	1.04	kg	6,000.00	6,216.00				
	Besi ulir	118.05	kg	3,350.00	395,470.85				
	Besi polos	81.27	kg	3,000.00	243,810.00				
	Multipleks 15 mm (33,333%)	1.98	lbr	60,000.00	39,575.60				
	Beton Ready Mix <i>fc' 25 Mpa</i>	1.00	m ³	274,000.00	274,000.00				
	Kayu Bekisting (33,333%)	0.07	m ³	1,700,000.00	40,799.59				
	Bendrat	3.62	kg	6,500.00	23,556.00				
	Minyak bekisting	1.04	ltr	12,500.00	12,950.00				1.036.378.05
	UPAH BORONGAN								
	Cor ready mix dengan pompa	1.00	m ³	9,250.00		9,250.00			
	Buat + stel besi	199.32	kg	215.00		42,854.02			
	Bekisting	5.18	m ²	10,850.00		56,203.00			
	Pompa	1.00	m ³	8,000.00		8,000.00			
	Pasang + bongkar scaffolding	5.18	m ²	2,500.00		12,950.00			
	Scaffolding	3.00	set	19,500.00		58,500.00			187,757.02
								Jumlah	1,224,135.06
								Dibulatkan	1,224,135.00
7	BALOK G5 (65/90)								
	BAHAN								
	Paku	1.04	kg	6,000.00	6,216.00				
	Besi ulir	104.41	kg	3,350.00	349,766.80				
	Besi polos	68.94	kg	3,000.00	206,817.00				
	Multipleks 15 mm (33,333%)	1.98	lbr	60,000.00	39,575.60				
	Beton Ready Mix <i>fc' 25 Mpa</i>	1.00	m ³	274,000.00	274,000.00				
	Kayu Bekisting (33,333%)	0.07	m ³	1,700,000.00	40,799.59				
	Bendrat	3.15	kg	6,500.00	20,481.50				
	Minyak bekisting	1.04	ltr	12,500.00	12,950.00				950,606.50
	UPAH BORONGAN								
	Cor ready mix dengan pompa	1.00	m ³	9,250.00		9,250.00			
	Buat + stel besi	173.35	kg	215.00		37,269.61			
	Bekisting	5.18	m ²	10,850.00		56,203.00			
	Pompa	1.00	m ³	8,000.00		8,000.00			
	Pasang + bongkar scaffolding	5.18	m ²	2,500.00		12,950.00			
	Scaffolding	3.00	set	19,500.00		58,500.00			182,172.61
								Jumlah	1,132,779.10
								Dibulatkan	1,132,779.00

12	BALOK G8 (65/90)							
	BAHAN							
	Paku	1.04	kg	6,000.00	6,216.00			
	Besi ulir	138.94	kg	3,350.00	465,445.65			
	Besi polos	69.09	kg	3,000.00	207,273.00			
	Multipleks 15 mm (33,333%)	1.98	lbr	60,000.00	39,575.60			
	Beton Ready Mix <i>f_c' 25 Mpa</i>	1.00	m ³	274,000.00	274,000.00			
	Kayu Bekisting (33,333%)	0.07	m ³	1,700,000.00	40,799.59			
	Bendrat	3.78	kg	6,500.00	24,583.00			
	Minyak bekisting	1.04	ltr	12,500.00	12,950.00			1,070,842.85
	UPAH BORONGAN							
	Cor ready mix dengan pompa	1.00	m ³	9,250.00		9,250.00		
	Buat + stel besi	208.03	kg	215.00		44,726.45		
Bekisting	5.18	m ²	10,850.00		56,203.00			
Pompa	1.00	m ³	8,000.00		8,000.00			
Pasang + bongkar scaffolding	5.18	m ²	2,500.00		12,950.00			
Scaffolding	3.00	set	19,500.00		58,500.00		189,621.45	
					Jumlah			1,260,472.30
					Dibulatkan			1,260,472.00
13	BALOK G9 (65/90)							
	BAHAN							
	Paku	1.04	kg	6,000.00	6,216.00			
	Besi ulir	200.66	kg	3,350.00	672,204.30			
	Besi polos	110.17	kg	3,000.00	330,498.00			
	Multipleks 15 mm (33,333%)	1.98	lbr	60,000.00	39,575.60			
	Beton Ready Mix <i>f_c' 25 Mpa</i>	1.00	m ³	274,000.00	274,000.00			
	Kayu Bekisting (33,333%)	0.07	m ³	1,700,000.00	40,799.59			
	Bendrat	5.65	kg	6,500.00	36,731.50			
	Minyak bekisting	1.04	ltr	12,500.00	12,950.00			1,412,975.00
	UPAH BORONGAN							
	Cor ready mix dengan pompa	1.00	m ³	9,250.00		9,250.00		
	Buat + stel besi	310.82	kg	215.00		66,827.16		
Bekisting	5.18	m ²	10,850.00		56,203.00			
Pompa	1.00	m ³	8,000.00		8,000.00			
Pasang + bongkar scaffolding	5.18	m ²	2,500.00		12,950.00			
Scaffolding	3.00	set	19,500.00		58,500.00		211,730.16	
					Jumlah			1,624,705.16
					Dibulatkan			1,624,705.00
14	BALOK G10 (65/90)							
	BAHAN							
	Paku	1.04	kg	6,000.00	6,216.00			
	Besi ulir	168.39	kg	3,350.00	564,113.20			
	Besi polos	110.17	kg	3,000.00	330,498.00			
	Multipleks 15 mm (33,333%)	1.98	lbr	60,000.00	39,575.60			
	Beton Ready Mix <i>f_c' 25 Mpa</i>	1.00	m ³	274,000.00	274,000.00			
	Kayu Bekisting (33,333%)	0.07	m ³	1,700,000.00	40,799.59			
	Bendrat	5.07	kg	6,500.00	32,922.50			
	Minyak bekisting	1.04	ltr	12,500.00	12,950.00			1,301,074.90
	UPAH BORONGAN							
	Cor ready mix dengan pompa	1.00	m ³	9,250.00		9,250.00		
	Buat + stel besi	278.56	kg	215.00		59,889.97		
Bekisting	5.18	m ²	10,850.00		56,203.00			
Pompa	1.00	m ³	8,000.00		8,000.00			
Pasang + bongkar scaffolding	5.18	m ²	2,500.00		12,950.00			
Scaffolding	3.00	set	19,500.00		58,500.00		204,792.97	
					Jumlah			1,505,867.87
					Dibulatkan			1,505,868.00
15	BALOK G10 (65/90)							
	BAHAN							
	Paku	1.04	kg	6,000.00	6,216.00			
	Besi ulir	200.66	kg	3,350.00	672,204.30			
	Besi polos	110.17	kg	3,000.00	330,498.00			
	Multipleks 15 mm (33,333%)	1.98	lbr	60,000.00	39,575.60			
	Beton Ready Mix <i>f_c' 25 Mpa</i>	1.00	m ³	274,000.00	274,000.00			
	Kayu Bekisting (33,333%)	0.07	m ³	1,700,000.00	40,799.59			
	Bendrat	5.65	kg	6,500.00	36,731.50			
	Minyak bekisting	1.04	ltr	12,500.00	12,950.00			1,412,975.00
	UPAH BORONGAN							
	Cor ready mix dengan pompa	1.00	m ³	9,250.00		9,250.00		
	Buat + stel besi	310.82	kg	215.00		66,827.16		
Bekisting	5.18	m ²	10,850.00		56,203.00			
Pompa	1.00	m ³	8,000.00		8,000.00			
Pasang + bongkar scaffolding	5.18	m ²	2,500.00		12,950.00			
Scaffolding	3.00	set	19,500.00		58,500.00		211,730.16	
					Jumlah			1,624,705.16
					Dibulatkan			1,624,705.00

16	BALOK G11 (65/90)								
	BAHAN								
	Paku	1.04	kg	6,000.00	6,216.00				
	Besi ulir	119.53	kg	3,350.00	400,412.10				
	Besi polos	96.21	kg	3,000.00	288,624.00				
	Multipleks 15 mm (33,333%)	1.98	lbr	60,000.00	39,575.60				
	Beton Ready Mix <i>fc' 25 Mpa</i>	1.00	m ³	274,000.00	274,000.00				
	Kayu Bekisting (33,333%)	0.07	m ³	1,700,000.00	40,799.59				
	Bendrat	3.92	kg	6,500.00	25,493.00				
	Minyak bekisting	1.04	ltr	12,500.00	12,950.00				1,088,070.30
	UPAH BORONGAN								
	Cor ready mix dengan pompa	1.00	m	9,250.00		9,250.00			
	Buat + stel besi	215.73	kg	215.00		46,382.81			
	Bekisting	5.18	m ²	10,850.00		56,203.00			
Pompa	1.00	m ³	8,000.00		8,000.00				
Pasang + bongkar scaffolding	5.18	m ²	2,500.00		12,950.00				
Scaffolding	3.00	set	19,500.00		58,500.00			191,285.81	
						Jumlah			1,279,356.11
						Dibulatkan			1,279,356.00
17	BALOK G12 (65/90)								
	BAHAN								
	Paku	1.04	kg	6,000.00	6,216.00				
	Besi ulir	151.55	kg	3,350.00	507,702.55				
	Besi polos	99.15	kg	3,000.00	297,447.00				
	Multipleks 15 mm (33,333%)	1.98	lbr	60,000.00	39,575.60				
	Beton Ready Mix <i>fc' 25 Mpa</i>	1.00	m ³	274,000.00	274,000.00				
	Kayu Bekisting (33,333%)	0.07	m ³	1,700,000.00	40,799.59				
	Bendrat	3.98	kg	6,500.00	25,844.00				
	Minyak bekisting	1.04	ltr	12,500.00	12,950.00				1,204,534.75
	UPAH BORONGAN								
	Cor ready mix dengan pompa	1.00	m ³	9,250.00		9,250.00			
	Buat + stel besi	250.70	kg	215.00		53,900.93			
	Bekisting	5.18	m ²	10,850.00		56,203.00			
Pompa	1.00	m ³	8,000.00		8,000.00				
Pasang + bongkar scaffolding	5.18	m ²	2,500.00		12,950.00				
Scaffolding	3.00	set	19,500.00		58,500.00			198,803.93	
						Jumlah			1,403,338.68
						Dibulatkan			1,403,339.00
18	BALOK G13 (40/70)								
	BAHAN								
	Paku	1.34	kg	6,000.00	8,064.00				
	Besi ulir	199.49	kg	3,350.00	668,281.45				
	Besi polos	63.84	kg	3,000.00	191,505.00				
	Multipleks 15 mm (33,333%)	2.57	lbr	60,000.00	51,341.49				
	Beton Ready Mix <i>fc' 25 Mpa</i>	1.00	m ³	274,000.00	274,000.00				
	Kayu Bekisting (33,333%)	0.09	m ³	1,700,000.00	52,926.14				
	Bendrat	4.79	kg	6,500.00	31,122.00				
	Minyak bekisting	1.34	ltr	12,500.00	16,800.00				1,291,040.07
	UPAH BORONGAN								
	Cor ready mix dengan pompa	1.00	m ³	9,250.00		9,250.00			
	Buat + stel besi	263.32	kg	215.00		56,614.23			
	Bekisting	6.72	m ²	10,850.00		72,912.00			
Pompa	1.00	m ³	8,000.00		8,000.00				
Pasang + bongkar scaffolding	6.72	m ²	2,500.00		16,800.00				
Scaffolding	3.00	set	19,500.00		58,500.00			222,076.23	
						Jumlah			1,516,116.30
						Dibulatkan			1,516,116.00
19	BALOK G14 (40/70)								
	BAHAN								
	Paku	1.34	kg	6,000.00	8,064.00				
	Besi ulir	165.76	kg	3,350.00	555,299.35				
	Besi polos	65.08	kg	3,000.00	195,240.00				
	Multipleks 15 mm (33,333%)	2.57	lbr	60,000.00	51,341.49				
	Beton Ready Mix <i>fc' 25 Mpa</i>	1.00	m ³	274,000.00	274,000.00				
	Kayu Bekisting (33,333%)	0.09	m ³	1,700,000.00	52,926.14				
	Bendrat	4.20	kg	6,500.00	27,280.50				
	Minyak bekisting	1.34	ltr	12,500.00	16,800.00				1,180,951.47
	UPAH BORONGAN								
	Cor ready mix dengan pompa	1.00	m ³	9,250.00		9,250.00			
	Buat + stel besi	230.84	kg	215.00		49,630.82			
	Bekisting	6.72	m ²	10,850.00		72,912.00			
Pompa	1.00	m ³	8,000.00		8,000.00				
Pasang + bongkar scaffolding	6.72	m ²	2,500.00		16,800.00				
Scaffolding	3.00	set	19,500.00		58,500.00			215,092.82	
						Jumlah			1,396,044.29
						Dibulatkan			1,396,044.00

24	BALOK B4 (40/50)								
	BAHAN								
	Paku	1.52	kg	6,000.00	9,120.00				
	Besi ulir	339.65	kg	3,350.00	1,137,817.45				
	Besi polos	85.12	kg	3,000.00	255,354.00				
	Multipleks 15 mm (33,333%)	2.90	lbr	60,000.00	58,063.42				
	Beton Ready Mix <i>fc' 25 Mpa</i>	1.00	m ³	274,000.00	274,000.00				
	Kayu Bekisting (33,333%)	0.11	m ³	1,700,000.00	59,839.40				
	Bendrat	7.72	kg	6,500.00	50,199.50				
	Minyak bekisting	1.52	ltr	12,500.00	19,000.00				1,863,393.77
	UPAH BORONGAN								
	Cor ready mix dengan pompa	1.00	m ³	9,250.00		9,250.00			
	Buat + stel besi	424.77	kg	215.00		91,324.48			
	Bekisting	7.60	m ²	10,850.00		82,460.00			
	Pompa	1.00	m ³	8,000.00		8,000.00			
	Pasang + bongkar scaffolding	7.60	m ²	2,500.00		19,000.00			
	Scaffolding	3.00	set	19,500.00		58,500.00			268,534.48
					Jumlah				2,131,928.25
					Dibulatkan				2,131,928.00
25	BALOK B5 (40/50)								
	BAHAN								
	Paku	1.52	kg	6,000.00	9,120.00				
	Besi ulir	216.26	kg	3,350.00	724,454.25				
	Besi polos	80.11	kg	3,000.00	240,339.00				
	Multipleks 15 mm (33,333%)	2.90	lbr	60,000.00	58,063.42				
	Beton Ready Mix <i>fc' 25 Mpa</i>	1.00	m ³	274,000.00	274,000.00				
	Kayu Bekisting (33,333%)	0.11	m ³	1,700,000.00	59,839.40				
	Bendrat	5.39	kg	6,500.00	35,028.50				
	Minyak bekisting	1.52	ltr	12,500.00	19,000.00				1,419,844.57
	UPAH BORONGAN								
	Cor ready mix dengan pompa	1.00	m ³	9,250.00		9,250.00			
	Buat + stel besi	296.37	kg	215.00		63,719.12			
	Bekisting	7.60	m ²	10,850.00		82,460.00			
	Pompa	1.00	m ³	8,000.00		8,000.00			
	Pasang + bongkar scaffolding	7.60	m ²	2,500.00		19,000.00			
	Scaffolding	3.00	set	19,500.00		58,500.00			240,929.12
					Jumlah				1,660,773.69
					Dibulatkan				1,660,774.00
II	BALOK LANTAI 3								
1	BALOK G1a (65/90)								
	BAHAN								
	Paku	1.04	kg	6,000.00	6,216.00				
	Besi ulir	140.08	kg	3,350.00	469,271.35				
	Besi polos	69.25	kg	3,000.00	207,738.00				
	Multipleks 15 mm (36,667%)	1.98	lbr	60,000.00	39,972.16				
	Beton Ready Mix <i>fc' 25 Mpa</i>	1.00	m ³	274,000.00	274,000.00				
	Kayu Bekisting (36,667%)	0.07	m ³	1,700,000.00	41,208.41				
	Bendrat	3.81	kg	6,500.00	24,739.00				
	Minyak bekisting	1.04	ltr	12,500.00	12,950.00				1,076,094.91
	UPAH BORONGAN								
	Cor ready mix dengan pompa	1.00	m ³	9,250.00		9,250.00			
	Buat + stel besi	209.33	kg	230.00		48,145.21			
	Bekisting	5.18	m ²	11,825.00		61,253.50			
	Pompa	1.00	m ³	8,000.00		8,000.00			
	Pasang + bongkar scaffolding	5.18	m ²	2,750.00		14,245.00			
	Scaffolding	3.00	set	19,500.00		58,500.00			199,393.71
					Jumlah				1,275,488.62
					Dibulatkan				1,275,489.00
2	BALOK G1a (65/90)								
	BAHAN								
	Paku	1.04	kg	6,000.00	6,216.00				
	Besi ulir	134.50	kg	3,350.00	450,585.05				
	Besi polos	69.25	kg	3,000.00	207,738.00				
	Multipleks 15 mm (36,667%)	1.98	lbr	60,000.00	39,972.16				
	Beton Ready Mix <i>fc' 25 Mpa</i>	1.00	m ³	274,000.00	274,000.00				
	Kayu Bekisting (36,667%)	0.07	m ³	1,700,000.00	41,208.41				
	Bendrat	3.71	kg	6,500.00	24,082.50				
	Minyak bekisting	1.04	ltr	12,500.00	12,950.00				1,056,752.11
	UPAH BORONGAN								
	Cor ready mix dengan pompa	1.00	m ³	9,250.00		9,250.00			
	Buat + stel besi	203.75	kg	230.00		46,862.27			
	Bekisting	5.18	m ²	11,825.00		61,253.50			
	Pompa	1.00	m ³	8,000.00		8,000.00			
	Pasang + bongkar scaffolding	5.18	m ²	2,750.00		14,245.00			
	Scaffolding	3.00	set	19,500.00		58,500.00			198,110.77
					Jumlah				1,254,862.88
					Dibulatkan				1,254,863.00

7	BALOK G3 (65/90)							
	BAHAN							
	Paku	1.04	kg	6,000.00	6,216.00			
	Besi ulir	133.02	kg	3,350.00	445,603.60			
	Besi polos	68.94	kg	3,000.00	206,817.00			
	Multipleks 15 mm (36,667%)	1.98	lbr	60,000.00	39,972.16			
	Beton Ready Mix <i>fc' 25 Mpa</i>	1.00	m ³	274,000.00	274,000.00			
	Kayu Bekisting (36,667%)	0.07	m ³	1,700,000.00	41,208.41			
	Bendrat	3.67	kg	6,500.00	23,861.50			
	Minyak bekisting	1.04	ltr	12,500.00	12,950.00			1,050,628.66
	UPAH BORONGAN							
	Cor ready mix dengan pompa	1.00	m ³	9,250.00		9,250.00		
	Buat + stel besi	201.96	kg	230.00		46,449.65		
	Bekisting	5.18	m ²	11,825.00		61,253.50		
	Pompa	1.00	m ³	8,000.00		8,000.00		
	Pasang + bongkar scaffolding	5.18	m ²	2,750.00		14,245.00		
	Scaffolding	3.00	set	19,500.00		58,500.00		197,698.15
					Jumlah			1,248,326.81
					Dibulatkan			1,248,327.00
8	BALOK G4a (65/90)							
	BAHAN							
	Paku	1.04	kg	6,000.00	6,216.00			
	Besi ulir	119.91	kg	3,350.00	401,698.50			
	Besi polos	68.94	kg	3,000.00	206,817.00			
	Multipleks 15 mm (36,667%)	1.98	lbr	60,000.00	39,972.16			
	Beton Ready Mix <i>fc' 25 Mpa</i>	1.00	m ³	274,000.00	274,000.00			
	Kayu Bekisting (36,667%)	0.07	m ³	1,700,000.00	41,208.41			
	Bendrat	3.43	kg	6,500.00	22,314.50			
	Minyak bekisting	1.04	ltr	12,500.00	12,950.00			1,005,176.56
	UPAH BORONGAN							
	Cor ready mix dengan pompa	1.00	m ³	9,250.00		9,250.00		
	Buat + stel besi	188.85	kg	230.00		43,435.27		
	Bekisting	5.18	m ²	11,825.00		61,253.50		
	Pompa	1.00	m ³	8,000.00		8,000.00		
	Pasang + bongkar scaffolding	5.18	m ²	2,750.00		14,245.00		
	Scaffolding	3.00	set	19,500.00		58,500.00		194,683.77
					Jumlah			1,199,860.33
					Dibulatkan			1,199,860.00
9	BALOK G4b (65/90)							
	BAHAN							
	Paku	1.04	kg	6,000.00	6,216.00			
	Besi ulir	132.57	kg	3,350.00	444,112.85			
	Besi polos	81.27	kg	3,000.00	243,810.00			
	Multipleks 15 mm (36,667%)	1.98	lbr	60,000.00	39,972.16			
	Beton Ready Mix <i>fc' 25 Mpa</i>	1.00	m ³	274,000.00	274,000.00			
	Kayu Bekisting (36,667%)	0.07	m ³	1,700,000.00	41,208.41			
	Bendrat	3.89	kg	6,500.00	25,272.00			
	Minyak bekisting	1.04	ltr	12,500.00	12,950.00			1,087,541.41
	UPAH BORONGAN							
	Cor ready mix dengan pompa	1.00	m ³	9,250.00		9,250.00		
	Buat + stel besi	213.84	kg	230.00		49,183.43		
	Bekisting	5.18	m ²	11,825.00		61,253.50		
	Pompa	1.00	m ³	8,000.00		8,000.00		
	Pasang + bongkar scaffolding	5.18	m ²	2,750.00		14,245.00		
	Scaffolding	3.00	set	19,500.00		58,500.00		200,431.93
					Jumlah			1,287,973.34
					Dibulatkan			1,287,973.00
10	BALOK G5 (65/90)							
	BAHAN							
	Paku	1.04	kg	6,000.00	6,216.00			
	Besi ulir	116.66	kg	3,350.00	390,804.30			
	Besi polos	68.94	kg	3,000.00	206,817.00			
	Multipleks 15 mm (36,667%)	1.98	lbr	60,000.00	39,972.16			
	Beton Ready Mix <i>fc' 25 Mpa</i>	1.00	m ³	274,000.00	274,000.00			
	Kayu Bekisting (36,667%)	0.07	m ³	1,700,000.00	41,208.41			
	Bendrat	3.37	kg	6,500.00	21,931.00			
	Minyak bekisting	1.04	ltr	12,500.00	12,950.00			993,898.86
	UPAH BORONGAN							
	Cor ready mix dengan pompa	1.00	m ³	9,250.00		9,250.00		
	Buat + stel besi	185.60	kg	230.00		42,687.31		
	Bekisting	5.18	m ²	11,825.00		61,253.50		
	Pompa	1.00	m ³	8,000.00		8,000.00		
	Pasang + bongkar scaffolding	5.18	m ²	2,750.00		14,245.00		
	Scaffolding	3.00	set	19,500.00		58,500.00		193,935.81
					Jumlah			1,187,834.67
					Dibulatkan			1,187,835.00

11	BALOK G5 (65/90)								
	BAHAN								
	Paku	1.04	kg	6,000.00	6,216.00				
	Besi ulir	133.16	kg	3,350.00	446,096.05				
	Besi polos	68.94	kg	3,000.00	206,817.00				
	Multipleks 15 mm (36,667%)	1.98	lbr	60,000.00	39,972.16				
	Beton Ready Mix <i>fc' 25 Mpa</i>	1.00	m ³	274,000.00	274,000.00				
	Kayu Bekisting (36,667%)	0.07	m ³	1,700,000.00	41,208.41				
	Bendrat	3.67	kg	6,500.00	23,881.00				
	Minyak bekisting	1.04	ltr	12,500.00	12,950.00				1,051,140.61
	UPAH BORONGAN								
	Cor ready mix dengan pompa	1.00	m ³	9,250.00			9,250.00		
	Buat + stel besi	202.10	kg	230.00			46,483.46		
	Bekisting	5.18	m ²	11,825.00			61,253.50		
	Pompa	1.00	m ³	8,000.00			8,000.00		
	Pasang + bongkar scaffolding	5.18	m ²	2,750.00			14,245.00		
	Scaffolding	3.00	set	19,500.00			58,500.00		197,731.96
						Jumlah			1,248,872.57
						Dibulatkan			1,248,873.00
12	BALOK G6 (65/90)								
	BAHAN								
	Paku	1.04	kg	6,000.00	6,216.00				
	Besi ulir	142.48	kg	3,350.00	477,301.30				
	Besi polos	81.27	kg	3,000.00	243,810.00				
	Multipleks 15 mm (36,667%)	1.98	lbr	60,000.00	39,972.16				
	Beton Ready Mix <i>fc' 25 Mpa</i>	1.00	m ³	274,000.00	274,000.00				
	Kayu Bekisting (36,667%)	0.07	m ³	1,700,000.00	41,208.41				
	Bendrat	4.07	kg	6,500.00	26,448.50				
	Minyak bekisting	1.04	ltr	12,500.00	12,950.00				1,121,906.36
	UPAH BORONGAN								
	Cor ready mix dengan pompa	1.00	m ³	9,250.00			9,250.00		
	Buat + stel besi	223.75	kg	230.00			51,462.04		
	Bekisting	5.18	m ²	11,825.00			61,253.50		
	Pompa	1.00	m ³	8,000.00			8,000.00		
	Pasang + bongkar scaffolding	5.18	m ²	2,750.00			14,245.00		
	Scaffolding	3.00	set	19,500.00			58,500.00		202,710.54
						Jumlah			1,324,616.90
						Dibulatkan			1,324,617.00
13	BALOK G6 (65/90)								
	BAHAN								
	Paku	1.04	kg	6,000.00	6,216.00				
	Besi ulir	135.82	kg	3,350.00	455,007.05				
	Besi polos	81.27	kg	3,000.00	243,810.00				
	Multipleks 15 mm (36,667%)	1.98	lbr	60,000.00	39,972.16				
	Beton Ready Mix <i>fc' 25 Mpa</i>	1.00	m ³	274,000.00	274,000.00				
	Kayu Bekisting (36,667%)	0.07	m ³	1,700,000.00	41,208.41				
	Bendrat	3.95	kg	6,500.00	25,662.00				
	Minyak bekisting	1.04	ltr	12,500.00	12,950.00				1,098,825.61
	UPAH BORONGAN								
	Cor ready mix dengan pompa	1.00	m ³	9,250.00			9,250.00		
	Buat + stel besi	217.09	kg	230.00			49,931.39		
	Bekisting	5.18	m ²	11,825.00			61,253.50		
	Pompa	1.00	m ³	8,000.00			8,000.00		
	Pasang + bongkar scaffolding	5.18	m ²	2,750.00			14,245.00		
	Scaffolding	3.00	set	19,500.00			58,500.00		201,179.89
						Jumlah			1,301,005.50
						Dibulatkan			1,301,006.00
14	BALOK G7 (65/90)								
	BAHAN								
	Paku	1.04	kg	6,000.00	6,216.00				
	Besi ulir	113.38	kg	3,350.00	379,816.30				
	Besi polos	81.60	kg	3,000.00	244,794.00				
	Multipleks 15 mm (36,667%)	1.98	lbr	60,000.00	39,972.16				
	Beton Ready Mix <i>fc' 25 Mpa</i>	1.00	m ³	274,000.00	274,000.00				
	Kayu Bekisting (36,667%)	0.07	m ³	1,700,000.00	41,208.41				
	Bendrat	3.55	kg	6,500.00	23,042.50				
	Minyak bekisting	1.04	ltr	12,500.00	12,950.00				1,021,999.36
	UPAH BORONGAN								
	Cor ready mix dengan pompa	1.00	m ³	9,250.00			9,250.00		
	Buat + stel besi	194.98	kg	230.00			44,844.48		
	Bekisting	5.18	m ²	11,825.00			61,253.50		
	Pompa	1.00	m ³	8,000.00			8,000.00		
	Pasang + bongkar scaffolding	5.18	m ²	2,750.00			14,245.00		
	Scaffolding	3.00	set	19,500.00			58,500.00		196,092.98
						Jumlah			1,218,092.34
						Dibulatkan			1,218,092.00

23	BALOK G15 (40/70)							
	BAHAN							
	Paku	1.34	kg	6,000.00	8,064.00			
	Besi ulir	244.99	kg	3,350.00	820,706.45			
	Besi polos	68.72	kg	3,000.00	206,145.00			
	Multipleks 15 mm (36,667%)	2.57	lbr	60,000.00	51,855.93			
	Beton Ready Mix <i>fc' 25 Mpa</i>	1.00	m ³	274,000.00	274,000.00			
	Kayu Bekisting (36,667%)	0.09	m ³	1,700,000.00	53,456.46			
	Bendrat	5.70	kg	6,500.00	37,069.50			
	Minyak bekisting	1.34	ltr	12,500.00	16,800.00			1,468,097.35
	UPAH BORONGAN							
	Cor ready mix dengan pompa	1.00	m ³	9,250.00		9,250.00		
	Buat + stel besi	313.70	kg	230.00		72,151.46		
	Bekisting	6.72	m ²	11,825.00		79,464.00		
	Pompa	1.00	m ³	8,000.00		8,000.00		
	Pasang + bongkar scaffolding	5.18	m ²	2,750.00		14,245.00		
	Scaffolding	3.00	set	19,500.00		58,500.00		241,610.46
					Jumlah			1,709,707.81
					Dibulatkan			1,709,708.00
24	BALOK B1a (40/50)							
	BAHAN							
	Paku	1.52	kg	6,000.00	9,120.00			
	Besi ulir	314.60	kg	3,350.00	1,053,910.00			
	Besi polos	83.77	kg	3,000.00	251,313.00			
	Multipleks 15 mm (36,667%)	2.90	lbr	60,000.00	58,645.22			
	Beton Ready Mix <i>fc' 25 Mpa</i>	1.00	m ³	274,000.00	274,000.00			
	Kayu Bekisting (36,667%)	0.11	m ³	1,700,000.00	60,439.00			
	Bendrat	7.24	kg	6,500.00	47,079.50			
	Minyak bekisting	1.52	ltr	12,500.00	19,000.00			1,773,506.72
	UPAH BORONGAN							
	Cor ready mix dengan pompa	1.00	m ³	9,250.00		9,250.00		
	Buat + stel besi	398.37	kg	230.00		91,625.33		
	Bekisting	7.60	m ²	11,825.00		89,870.00		
	Pompa	1.00	m ³	8,000.00		8,000.00		
	Pasang + bongkar scaffolding	5.18	m ²	2,750.00		14,245.00		
	Scaffolding	3.00	set	19,500.00		58,500.00		271,490.33
					Jumlah			2,044,997.05
					Dibulatkan			2,044,997.00
25	BALOK B1b (40/50)							
	BAHAN							
	Paku	1.52	kg	6,000.00	9,120.00			
	Besi ulir	319.51	kg	3,350.00	1,070,365.20			
	Besi polos	85.33	kg	3,000.00	255,996.00			
	Multipleks 15 mm (36,667%)	2.90	lbr	60,000.00	58,645.22			
	Beton Ready Mix <i>fc' 25 Mpa</i>	1.00	m ³	274,000.00	274,000.00			
	Kayu Bekisting (36,667%)	0.11	m ³	1,700,000.00	60,439.00			
	Bendrat	7.36	kg	6,500.00	47,840.00			
	Minyak bekisting	1.52	ltr	12,500.00	19,000.00			1,795,405.42
	UPAH BORONGAN							
	Cor ready mix dengan pompa	1.00	m ³	9,250.00		9,250.00		
	Buat + stel besi	404.84	kg	230.00		93,114.12		
	Bekisting	7.60	m ²	11,825.00		89,870.00		
	Pompa	1.00	m ³	8,000.00		8,000.00		
	Pasang + bongkar scaffolding	5.18	m ²	2,750.00		14,245.00		
	Scaffolding	3.00	set	19,500.00		58,500.00		272,979.12
					Jumlah			2,068,384.54
					Dibulatkan			2,068,385.00
26	BALOK B1c (40/50)							
	BAHAN							
	Paku	1.52	kg	6,000.00	9,120.00			
	Besi ulir	271.04	kg	3,350.00	907,984.00			
	Besi polos	75.55	kg	3,000.00	226,644.00			
	Multipleks 15 mm (36,667%)	2.90	lbr	60,000.00	58,645.22			
	Beton Ready Mix <i>fc' 25 Mpa</i>	1.00	m ³	274,000.00	274,000.00			
	Kayu Bekisting (36,667%)	0.11	m ³	1,700,000.00	60,439.00			
	Bendrat	6.30	kg	6,500.00	40,963.00			
	Minyak bekisting	1.52	ltr	12,500.00	19,000.00			1,596,795.22
	UPAH BORONGAN							
	Cor ready mix dengan pompa	1.00	m ³	9,250.00		9,250.00		
	Buat + stel besi	345.59	kg	230.00		79,715.24		
	Bekisting	7.60	m ²	11,825.00		89,870.00		
	Pompa	1.00	m ³	8,000.00		8,000.00		
	Pasang + bongkar scaffolding	5.18	m ²	2,750.00		14,245.00		
	Scaffolding	3.00	set	19,500.00		58,500.00		259,580.24
					Jumlah			1,856,375.46
					Dibulatkan			1,856,375.00

27	BALOK B2 (40/50)							
	BAHAN							
	Paku	1.52	kg	6,000.00	9,120.00			
	Besi ulir	216.70	kg	3,350.00	725,945.00			
	Besi polos	83.77	kg	3,000.00	251,313.00			
	Multipleks 15 mm (36.667%)	2.90	lbr	60,000.00	58,645.22			
	Beton Ready Mix f_c ' 25 Mpa	1.00	m ³	274,000.00	274,000.00			
	Kayu Bekisting (36.667%)	0.11	m ³	1,700,000.00	60,439.00			
	Bendrat	5.46	kg	6,500.00	35,509.50			
	Minyak bekisting	1.52	ltr	12,500.00	19,000.00			1.433,071.72
	UPAH BORONGAN							
	Cor ready mix dengan pompa	1.00	m ³	9,250.00		9,250.00		
	Buat + stel besi	300.47	kg	230.00		69,108.33		
	Bekisting	7.60	m ²	11,825.00		89,870.00		
	Pompa	1.00	m ³	8,000.00		8,000.00		
	Pasang + bongkar scaffolding	5.18	m ²	2,750.00		14,245.00		
	Scaffolding	3.00	set	19,500.00		58,500.00		248,973.33
					Jumlah			1,682,945.05
					Dibulatkan			1,682,945.00
28	BALOK B3 (40/50)							
	BAHAN							
	Paku	1.52	kg	6,000.00	9,120.00			
	Besi ulir	246.05	kg	3,350.00	824,280.90			
	Besi polos	85.12	kg	3,000.00	255,354.00			
	Multipleks 15 mm (36.667%)	2.90	lbr	60,000.00	58,645.22			
	Beton Ready Mix f_c ' 25 Mpa	1.00	m ³	274,000.00	274,000.00			
	Kayu Bekisting (36.667%)	0.11	m ³	1,700,000.00	60,439.00			
	Bendrat	6.02	kg	6,500.00	39,143.00			
	Minyak bekisting	1.52	ltr	12,500.00	19,000.00			
	UPAH BORONGAN							
	Cor ready mix dengan pompa	1.00	m ³	9,250.00		9,250.00		
	Buat + stel besi	331.17	kg	230.00		76,169.56		
	Bekisting	7.60	m ²	11,825.00		89,870.00		
	Pompa	1.00	m ³	8,000.00		8,000.00		
	Pasang + bongkar scaffolding	5.18	m ²	2,750.00		14,245.00		
	Scaffolding	3.00	set	19,500.00		58,500.00		256,034.56
					Jumlah			1,796,016.68
					Dibulatkan			1,796,017.00
29	BALOK B4 (40/50)							
	BAHAN							
	Paku	1.52	kg	6,000.00	9,120.00			
	Besi ulir	339.65	kg	3,350.00	1,137,817.45			
	Besi polos	85.12	kg	3,000.00	255,354.00			
	Multipleks 15 mm (36.667%)	2.90	lbr	60,000.00	58,645.22			
	Beton Ready Mix f_c ' 25 Mpa	1.00	m ³	274,000.00	274,000.00			
	Kayu Bekisting (36.667%)	0.11	m ³	1,700,000.00	60,439.00			
	Bendrat	7.72	kg	6,500.00	50,199.50			
	Minyak bekisting	1.52	ltr	12,500.00	19,000.00			
	UPAH BORONGAN							
	Cor ready mix dengan pompa	1.00	m ³	9,250.00		9,250.00		
	Buat + stel besi	424.77	kg	230.00		97,695.95		
	Bekisting	7.60	m ²	11,825.00		89,870.00		
	Pompa	1.00	m ³	8,000.00		8,000.00		
	Pasang + bongkar scaffolding	5.18	m ²	2,750.00		14,245.00		
	Scaffolding	3.00	set	19,500.00		58,500.00		277,560.95
					Jumlah			2,142,136.12
					Dibulatkan			2,142,136.00
30	BALOK B5 (40/50)							
	BAHAN							
	Paku	1.52	kg	6,000.00	9,120.00			
	Besi ulir	216.26	kg	3,350.00	724,454.25			
	Besi polos	80.11	kg	3,000.00	240,339.00			
	Multipleks 15 mm (36.667%)	2.90	lbr	60,000.00	58,645.22			
	Beton Ready Mix f_c ' 25 Mpa	1.00	m ³	274,000.00	274,000.00			
	Kayu Bekisting (36.667%)	0.11	m ³	1,700,000.00	60,439.00			
	Bendrat	5.39	kg	6,500.00	35,028.50			
	Minyak bekisting	1.52	ltr	12,500.00	19,000.00			
	UPAH BORONGAN							
	Cor ready mix dengan pompa	1.00	m ³	9,250.00		9,250.00		
	Buat + stel besi	296.37	kg	230.00		68,164.64		
	Bekisting	7.60	m ²	11,825.00		89,870.00		
	Pompa	1.00	m ³	8,000.00		8,000.00		
	Pasang + bongkar scaffolding	5.18	m ²	2,750.00		14,245.00		
	Scaffolding	3.00	set	19,500.00		58,500.00		248,029.64
					Jumlah			1,669,055.61
					Dibulatkan			1,669,056.00

7	BALOK G5 (65/90)								
	BAHAN								
	Paku	1.04	kg	6,000.00	6,216.00				
	Besi ulir	104.29	kg	3,350.00	349,358.10				
	Besi polos	68.94	kg	3,000.00	206,817.00				
	Multipleks 15 mm (36,667%)	1.98	lbr	60,000.00	39,972.16				
	Beton Ready Mix <i>fc' 25 Mpa</i>	1.00	m ³	274,000.00	274,000.00				
	Kayu Bekisting (36,667%)	0.07	m ³	1,700,000.00	41,208.41				
	Bendrat	3.15	kg	6,500.00	20,468.50				
	Minyak bekisting	1.04	ltr	12,500.00	12,950.00				950,990.16
	UPAH BORONGAN								
	Cor ready mix dengan pompa	1.00	m ³	9,250.00		9,250.00			
	Buat + stel besi	173.23	kg	245.00		42,440.13			
	Bekisting	5.18	m ²	12,800.00		66,304.00			
	Pompa	1.00	m ³	8,000.00		8,000.00			
	Pasang + bongkar scaffolding	5.18	m ²	3,050.00		15,799.00			
	Scaffolding	3.00	set	19,500.00		58,500.00			200,293.13
					Jumlah				1,151,283.29
					Dibulatkan				1,151,283.00
8	BALOK G5 (65/90)								
	BAHAN								
	Paku	1.04	kg	6,000.00	6,216.00				
	Besi ulir	119.47	kg	3,350.00	400,224.50				
	Besi polos	68.94	kg	3,000.00	206,817.00				
	Multipleks 15 mm (36,667%)	1.98	lbr	60,000.00	39,972.16				
	Beton Ready Mix <i>fc' 25 Mpa</i>	1.00	m ³	274,000.00	274,000.00				
	Kayu Bekisting (36,667%)	0.07	m ³	1,700,000.00	41,208.41				
	Bendrat	3.43	kg	6,500.00	22,288.50				
	Minyak bekisting	1.04	ltr	12,500.00	12,950.00				1,003,676.56
	UPAH BORONGAN								
	Cor ready mix dengan pompa	1.00	m ³	9,250.00		9,250.00			
	Buat + stel besi	188.41	kg	245.00		46,160.21			
	Bekisting	5.18	m ²	12,800.00		66,304.00			
	Pompa	1.00	m ³	8,000.00		8,000.00			
	Pasang + bongkar scaffolding	5.18	m ²	3,050.00		15,799.00			
	Scaffolding	3.00	set	19,500.00		58,500.00			204,013.21
					Jumlah				1,207,689.77
					Dibulatkan				1,207,690.00
9	BALOK G6 (65/90)								
	BAHAN								
	Paku	1.04	kg	6,000.00	6,216.00				
	Besi ulir	126.97	kg	3,350.00	425,362.90				
	Besi polos	81.27	kg	3,000.00	243,810.00				
	Multipleks 15 mm (36,667%)	1.98	lbr	60,000.00	39,972.16				
	Beton Ready Mix <i>fc' 25 Mpa</i>	1.00	m ³	274,000.00	274,000.00				
	Kayu Bekisting (36,667%)	0.07	m ³	1,700,000.00	41,208.41				
	Bendrat	3.79	kg	6,500.00	24,615.50				
	Minyak bekisting	1.04	ltr	12,500.00	12,950.00				1,068,134.96
	UPAH BORONGAN								
	Cor ready mix dengan pompa	1.00	m ³	9,250.00		9,250.00			
	Buat + stel besi	208.24	kg	245.00		51,019.78			
	Bekisting	5.18	m ²	12,800.00		66,304.00			
	Pompa	1.00	m ³	8,000.00		8,000.00			
	Pasang + bongkar scaffolding	5.18	m ²	3,050.00		15,799.00			
	Scaffolding	3.00	set	19,500.00		58,500.00			208,872.78
					Jumlah				1,277,007.74
					Dibulatkan				1,277,008.00
10	BALOK G6 (65/90)								
	BAHAN								
	Paku	1.04	kg	6,000.00	6,216.00				
	Besi ulir	111.89	kg	3,350.00	374,821.45				
	Besi polos	81.27	kg	3,000.00	243,810.00				
	Multipleks 15 mm (36,667%)	1.98	lbr	60,000.00	39,972.16				
	Beton Ready Mix <i>fc' 25 Mpa</i>	1.00	m ³	274,000.00	274,000.00				
	Kayu Bekisting (36,667%)	0.07	m ³	1,700,000.00	41,208.41				
	Bendrat	3.51	kg	6,500.00	22,828.00				
	Minyak bekisting	1.04	ltr	12,500.00	12,950.00				1,015,806.01
	UPAH BORONGAN								
	Cor ready mix dengan pompa	1.00	m ³	9,250.00		9,250.00			
	Buat + stel besi	193.16	kg	245.00		47,323.47			
	Bekisting	5.18	m ²	12,800.00		66,304.00			
	Pompa	1.00	m ³	8,000.00		8,000.00			
	Pasang + bongkar scaffolding	5.18	m ²	3,050.00		15,799.00			
	Scaffolding	3.00	set	19,500.00		58,500.00			205,176.47
					Jumlah				1,220,982.48
					Dibulatkan				1,220,982.00

19	BALOK G15 (40/70)							
	BAHAN							
	Paku	1.34	kg	6,000.00	8,064.00			
	Besi ulir	244.99	kg	3,350.00	820,706.45			
	Besi polos	68.72	kg	3,000.00	206,145.00			
	Multipleks 15 mm (36,667%)	2.57	lbr	60,000.00	51,855.93			
	Beton Ready Mix <i>fc' 25 Mpa</i>	1.00	m ³	274,000.00	274,000.00			
	Kayu Bekisting (36,667%)	0.09	m ³	1,700,000.00	53,456.46			
	Bendrat	5.70	kg	6,500.00	37,069.50			
	Minyak bekisting	1.34	ltr	12,500.00	16,800.00			1.468,097.35
	UPAH BORONGAN							
	Cor ready mix dengan pompa	1.00	m ³	9,250.00		9,250.00		
	Buat + stel besi	313.70	kg	245.00		76,856.99		
	Bekisting	6.72	m ²	12,800.00		86,016.00		
	Pompa	1.00	m ³	8,000.00		8,000.00		
	Pasang + bongkar scaffolding	5.18	m ²	3,050.00		15,799.00		
	Scaffolding	3.00	set	19,500.00		58,500.00		254,421.99
					Jumlah			1,722,519.34
					Dibulatkan			1,722,519.00
20	BALOK B1 (40/50)							
	BAHAN							
	Paku	1.52	kg	6,000.00	9,120.00			
	Besi ulir	314.60	kg	3,350.00	1,053,910.00			
	Besi polos	83.77	kg	3,000.00	251,313.00			
	Multipleks 15 mm (36,667%)	2.90	lbr	60,000.00	58,645.22			
	Beton Ready Mix <i>fc' 25 Mpa</i>	1.00	m ³	274,000.00	274,000.00			
	Kayu Bekisting (36,667%)	0.11	m ³	1,700,000.00	60,439.00			
	Bendrat	7.24	kg	6,500.00	47,079.50			
	Minyak bekisting	1.52	ltr	12,500.00	19,000.00			
	UPAH BORONGAN							
	Cor ready mix dengan pompa	1.00	m ³	9,250.00		9,250.00		
	Buat + stel besi	398.37	kg	245.00		97,600.90		
	Bekisting	7.60	m ²	12,800.00		97,280.00		
	Pompa	1.00	m ³	8,000.00		8,000.00		
	Pasang + bongkar scaffolding	5.18	m ²	3,050.00		15,799.00		
	Scaffolding	3.00	set	19,500.00		58,500.00		286,429.90
					Jumlah			2,059,936.61
					Dibulatkan			2,059,937.00
21	BALOK B2 (40/50)							
	BAHAN							
	Paku	1.52	kg	6,000.00	9,120.00			
	Besi ulir	216.70	kg	3,350.00	725,945.00			
	Besi polos	83.77	kg	3,000.00	251,313.00			
	Multipleks 15 mm (36,667%)	2.90	lbr	60,000.00	58,645.22			
	Beton Ready Mix <i>fc' 25 Mpa</i>	1.00	m ³	274,000.00	274,000.00			
	Kayu Bekisting (36,667%)	0.11	m ³	1,700,000.00	60,439.00			
	Bendrat	5.46	kg	6,500.00	35,509.50			
	Minyak bekisting	1.52	ltr	12,500.00	19,000.00			
	UPAH BORONGAN							
	Cor ready mix dengan pompa	1.00	m ³	9,250.00		9,250.00		
	Buat + stel besi	300.47	kg	245.00		73,615.40		
	Bekisting	7.60	m ²	12,800.00		97,280.00		
	Pompa	1.00	m ³	8,000.00		8,000.00		
	Pasang + bongkar scaffolding	5.18	m ²	3,050.00		15,799.00		
	Scaffolding	3.00	set	19,500.00		58,500.00		262,444.40
					Jumlah			1,696,416.11
					Dibulatkan			1,696,416.00
22	BALOK B3 a (40/50)							
	BAHAN							
	Paku	1.52	kg	6,000.00	9,120.00			
	Besi ulir	216.70	kg	3,350.00	725,945.00			
	Besi polos	83.77	kg	3,000.00	251,313.00			
	Multipleks 15 mm (36,667%)	2.90	lbr	60,000.00	58,645.22			
	Beton Ready Mix <i>fc' 25 Mpa</i>	1.00	m ³	274,000.00	274,000.00			
	Kayu Bekisting (36,667%)	0.11	m ³	1,700,000.00	60,439.00			
	Bendrat	5.46	kg	6,500.00	35,509.50			
	Minyak bekisting	1.52	ltr	12,500.00	19,000.00			
	UPAH BORONGAN							
	Cor ready mix dengan pompa	1.00	m ³	9,250.00		9,250.00		
	Buat + stel besi	300.47	kg	245.00		73,615.40		
	Bekisting	7.60	m ²	12,800.00		97,280.00		
	Pompa	1.00	m ³	8,000.00		8,000.00		
	Pasang + bongkar scaffolding	5.18	m ²	3,050.00		15,799.00		
	Scaffolding	3.00	set	19,500.00		58,500.00		262,444.40
					Jumlah			1,696,416.11
					Dibulatkan			1,696,416.00

ANALISA HARGA PEKERJAAN BALOK LANTAI

No	Uraian Pekerjaan	Volume	Sat.	Harga Satuan (Rp)	Harga Tiap Pekerjaan (Rp)	Harga Total Tiap Pekerjaan (Rp)
VII	PEKERJAAN BALOK					
I	LANTAI 2					
1	Beton balok G1 (65/90)	17.17	m ³	1,457,178.35	25,297,198.48	
2	Beton balok G1 (65/90)	25.74	m ³	1,422,268.34	36,609,187.10	
3	Beton balok G2 (65/90)	8.58	m ³	1,482,535.87	12,720,157.78	
4	Beton balok G3 (65/90)	13.00	m ³	1,224,101.21	15,913,315.75	
5	Beton balok G4a (65/90)	13.00	m ³	1,299,391.38	16,892,087.89	
6	Beton balok G4b (65/90)	11.19	m ³	1,224,135.06	13,698,071.34	
7	Beton balok G5 (65/90)	4.33	m ³	1,132,779.10	4,904,933.51	
8	Beton balok G5 (65/90)	8.67	m ³	1,189,162.06	10,310,035.03	
9	Beton balok G6 (65/90)	5.60	m ³	1,291,826.57	7,234,228.77	
10	Beton balok G6 (65/90)	5.60	m ³	1,290,550.81	7,227,084.54	
11	Beton balok G7 (65/90)	5.55	m ³	1,208,016.84	6,704,493.44	
12	Beton balok G8 (65/90)	8.63	m ³	1,260,472.30	10,877,875.92	
13	Beton balok G9 (65/90)	17.64	m ³	1,624,705.16	28,659,798.96	
14	Beton balok G10 (65/90)	2.52	m ³	1,505,867.87	3,794,787.02	
15	Beton balok G10 (65/90)	10.08	m ³	1,624,705.16	16,377,027.97	
16	Beton balok G11 (65/90)	7.89	m ³	1,279,356.11	10,094,119.68	
17	Beton balok G12 (65/90)	11.19	m ³	1,403,338.68	15,703,359.79	
18	Beton balok G13 (40/70)	9.47	m ³	1,516,116.30	14,357,621.40	
19	Beton balok G14 (40/70)	2.55	m ³	1,396,044.29	3,559,912.94	
20	Beton balok G15 (40/70)	9.47	m ³	1,699,960.50	16,098,625.97	
21	Beton balok B1 (40/50)	49.37	m ³	2,035,185.09	100,477,087.69	
22	Beton balok B2 (40/50)	3.09	m ³	1,674,601.59	5,174,518.90	
23	Beton balok B3 (40/50)	15.93	m ³	1,787,212.70	28,470,298.33	
24	Beton balok B4 (40/50)	3.98	m ³	2,131,928.25	8,485,074.42	
25	Beton balok B5 (40/50)	3.74	m ³	1,660,773.69	6,211,293.60	425,852,196.21
II	LANTAI 3					
1	Beton balok G1a (65/90)	4.29	m ³	1,275,488.62	5,471,846.20	
2	Beton balok G1a (65/90)	8.58	m ³	1,254,862.88	10,766,723.54	
3	Beton balok G1a (65/90)	8.58	m ³	1,407,939.08	12,080,117.34	
4	Beton balok G1b (65/90)	2.89	m ³	1,584,265.13	4,578,526.24	
5	Beton balok G2 (65/90)	5.70	m ³	1,287,521.75	7,338,874.00	
6	Beton balok G2 (65/90)	5.71	m ³	1,334,646.11	7,620,829.31	
7	Beton balok G3 (65/90)	13.00	m ³	1,248,326.81	16,228,248.58	
8	Beton balok G4a (65/90)	13.00	m ³	1,199,860.33	15,598,184.34	
9	Beton balok G4b (65/90)	11.19	m ³	1,287,973.34	14,412,421.72	
10	Beton balok G5 (65/90)	4.33	m ³	1,187,834.67	5,143,324.14	
11	Beton balok G5 (65/90)	8.67	m ³	1,248,872.57	10,827,725.21	
12	Beton balok G6 (65/90)	5.60	m ³	1,324,616.90	7,417,854.66	
13	Beton balok G6 (65/90)	5.60	m ³	1,300,005.50	7,280,030.82	
14	Beton balok G7 (65/90)	5.55	m ³	1,218,092.34	6,760,412.51	











15	Beton balok G8 (65/90)	8.63	m ³	1,202,068.93	10,373,854.90	
16	Beton balok G9 (65/90)	17.64	m ³	1,636,518.38	28,868,184.29	
17	Beton balok G10 (65/90)	2.52	m ³	1,331,985.62	3,356,603.77	
18	Beton balok G10 (65/90)	10.08	m ³	1,636,518.38	16,496,105.31	
19	Beton balok G11 (65/90)	7.89	m ³	1,233,775.76	9,734,490.78	
20	Beton balok G12 (65/90)	11.19	m ³	1,418,039.57	15,867,862.83	
21	Beton balok G13 (40/70)	9.47	m ³	1,525,107.91	14,442,771.87	
22	Beton balok G14 (40/70)	2.55	m ³	1,404,548.68	3,581,599.12	
23	Beton balok G15 (40/70)	9.47	m ³	1,709,707.81	16,190,932.92	
24	Beton balok B1a (40/50)	32.40	m ³	2,044,997.05	66,257,904.39	
25	Beton balok B1b (40/50)	4.06	m ³	2,068,384.54	8,397,641.23	
26	Beton balok B1c (40/50)	1.00	m ³	1,856,375.46	1,856,375.46	
27	Beton balok B2 (40/50)	3.09	m ³	1,682,945.05	5,200,300.20	
28	Beton balok B3 (40/50)	15.93	m ³	1,796,016.68	28,610,545.70	
29	Beton balok B4 (40/50)	5.97	m ³	2,142,136.12	12,788,552.63	
30	Beton balok B5 (40/50)	4.67	m ³	1,669,055.61	7,794,489.69	
31	Beton balok BLa (40/90)	1.95	m ³	2,103,298.61	4,101,432.28	
32	Beton balok BLb (40/90)	1.26	m ³	1,981,686.05	2,496,924.42	387,941,690.38
III	ATAP					
1	Beton balok G1 (65/90)	25.74	m ³	1,183,514.60	30,463,665.77	
2	Beton balok G1 (65/90)	17.17	m ³	1,285,233.03	22,067,451.10	
3	Beton balok G2 (65/90)	8.58	m ³	1,213,657.90	10,413,184.81	
4	Beton balok G3 (65/90)	13.00	m ³	1,178,652.49	15,322,482.35	
5	Beton balok G4a (65/90)	13.00	m ³	1,160,946.03	15,092,298.37	
6	Beton balok G4b (65/90)	11.19	m ³	1,243,171.10	13,911,084.65	
7	Beton balok G5 (65/90)	8.67	m ³	1,151,283.29	9,981,626.11	
8	Beton balok G5 (65/90)	8.67	m ³	1,207,689.77	10,470,670.30	
9	Beton balok G6 (65/90)	5.60	m ³	1,277,007.74	7,151,243.37	
10	Beton balok G6 (65/90)	5.60	m ³	1,220,982.48	6,837,501.88	
11	Beton balok G7 (65/90)	5.55	m ³	1,187,174.15	6,588,816.53	
12	Beton balok G8 (65/90)	8.63	m ³	1,211,057.23	10,451,423.88	
13	Beton balok G9 (65/90)	17.64	m ³	1,534,838.03	27,074,542.92	
14	Beton balok G10 (65/90)	2.52	m ³	1,342,017.28	3,381,883.54	
15	Beton balok G10 (65/90)	10.08	m ³	1,534,838.03	15,471,167.38	
16	Beton balok G11 (65/90)	7.89	m ³	1,243,389.26	9,810,341.29	
17	Beton balok G13 (40/70)	9.47	m ³	1,537,163.74	14,556,940.58	
18	Beton balok G14 (40/70)	2.55	m ³	1,416,117.29	3,611,099.09	
19	Beton balok G15 (40/70)	9.47	m ³	1,722,519.34	16,312,258.11	
20	Beton balok B1 (40/50)	43.20	m ³	2,059,936.61	88,989,261.73	
21	Beton balok B2 (40/50)	3.09	m ³	1,696,416.11	5,241,925.79	
22	Beton balok B3a (40/50)	9.26	m ³	1,696,416.11	15,708,813.22	
23	Beton balok B3b (40/50)	16.54	m ³	1,775,111.54	29,360,344.86	
24	Beton balok B4 (40/50)	3.98	m ³	2,157,471.59	8,586,736.94	
25	Beton balok B5 (40/50)	5.61	m ³	1,682,465.13	9,438,629.37	406,295,393.96
Harga Pekerjaan Balok Lantai						1,220,089,280.55





Perhitungan Volume Beton dan Volume Bekisting Pelat Lantai

No	Type	Lebar Pelat (m)	Panjang Pelat (m)	Lebar Aktual (m)	Panjang Aktual (m)	Tebal Pelat (m)	Jumlah Tipe	Volume Bekisting (m ²)	Volume Bekisting Total (m ²)	Volume Beton (m ³)	Vol. Beton Total (m ³)
a	b	c	d	e	f	g	h	i = e*f	j = h*i	k = c*d*g	l = h*k
LANTAI 2											
1	P1	3.60	3.60	3.075	3.075	0.12	52	9.46	491.69	1.56	80.87
2	P2	3.60	3.60	3.075	3.075	0.12	44	9.46	416.05	1.56	68.43
3	P2	3.60	1.67	3.200	1.270	0.12	10	4.06	40.64	0.72	7.21
4	P3	1.80	1.80	1.400	1.400	0.12	8	1.96	15.68	0.39	3.11
										<i>Jumlah</i>	<i>159.62</i>
LANTAI 3											
1	P1	3.60	3.60	3.075	3.075	0.12	43	9.46	406.59	1.56	66.87
2	P2	3.60	3.60	3.075	3.075	0.12	44	9.46	416.05	1.56	68.43
3	P2	3.60	1.67	3.200	1.270	0.12	10	4.06	40.64	0.72	7.21
4	P3	1.80	1.80	1.400	1.400	0.12	8	1.96	15.68	0.39	3.11
										<i>Jumlah</i>	<i>145.63</i>
ATAP											
1	PA	3.60	3.60	3.075	3.075	0.10	98	9.46	926.65	1.30	127.01
2	PA	3.60	1.67	3.200	1.270	0.10	10	4.06	40.64	0.60	6.01
3	PW	3.60	3.60	3.075	3.075	0.10	4	9.46	37.82	1.30	5.18
										<i>Jumlah</i>	<i>138.20</i>

Perhitungan Kebutuhan Besi Tulangan Pelat Lantai

Type	Jenis	Panjang Plat (m)	Lebar Plat (m)	φ Besi (m)	Jarak antar Tulangan (m)	Kait Tulangan (m)	Jumlah Tipe	Panjang 1 bh Tulangan (m)	Berat Besi (kg/m)	Jumlah Tulangan	Berat Tulangan (kg)
a	b	c	d	e	f	g = 2*5*e	h	i = ((0.5*c)+g)*h	j	k = ((c-0.4)/f)+1	l = i*j*k
P 1		3.60	3.60	0.010	0.10	0.10	4	7.60	0.62	33	155.50
		3.60	3.60	0.008	0.30	0.08	2	5.56	0.37	12	24.69
		3.60	3.60	0.008	0.30	-	2	7.20	0.37	12	31.97
		3.60	3.60	0.010	0.20	0.10	2	9.30	0.62	17	98.02
		3.60	3.60	0.010	0.20	0.10	2	9.30	0.62	17	98.02
<i>Jumlah</i>											408.20
P 2		3.60	3.60	0.010	0.13	0.10	4	7.60	0.62	27	127.22
		3.60	3.60	0.008	0.30	0.08	2	5.56	0.37	12	24.69
		3.60	3.60	0.008	0.30	-	2	7.2	0.37	12	31.97
		3.60	3.60	0.010	0.25	0.10	2	9.30	0.62	14	80.72
		3.60	3.60	0.010	0.25	0.10	2	9.30	0.62	14	80.72
<i>Jumlah</i>											345.33

P 3		1.80	1.80	0.010	0.13	0.10	4	4.00	0.62	12	29.76
		1.80	1.80	0.008	0.30	0.08	2	1.96	0.37	6	4.35
		1.80	1.80	0.008	0.30	-	2	1.80	0.37	6	4.00
		1.80	1.80	0.010	0.25	0.10	2	2.00	0.62	7	8.68
		1.80	1.80	0.010	0.25	0.10	2	2.00	0.62	7	8.68
<i>Jumlah</i>											55.47
P A		3.60	3.60	0.010	0.10	0.10	4	7.60	0.62	33	155.50
		3.60	3.60	0.008	0.30	0.08	2	5.56	0.37	12	24.69
		3.60	3.60	0.008	0.30	-	2	7.20	0.37	12	31.97
		3.60	3.60	0.010	0.20	0.10	2	9.30	0.62	17	98.02
		3.60	3.60	0.010	0.20	0.10	2	9.30	0.62	17	98.02
<i>Jumlah</i>											408.19

PW		3.60	3.60	0.010	0.09	0.12	4	7.68	0.62	37	176.18
		3.60	3.60	0.008	0.30	0.10	2	5.59	0.37	12	24.83
		3.60	3.60	0.008	0.30	-	2	7.20	0.37	12	31.97
		3.60	3.60	0.010	0.18	0.12	2	9.34	0.62	19	110.03
		3.60	3.60	0.010	0.18	0.12	2	9.34	0.62	19	110.03
<i>Jumlah</i>										453.03	

**DAFTAR ANALISA HARGA SATUAN
PEKERJAAN PELAT**

No	Uraian	Volume	Sat.	Harga Satuan (Rp)	Analisa Harga Bahan (Rp)	Analisa Harga Upah (Rp)	Total Harga Analisa (Rp)
VIII	PEKERJAAN BETON PELAT						
I	PELAT LANTAI II						
I	PFLAT P1 (3,60 x 3,60) m ²						
	BAHAN						
	Paku	1.21	kg	6,000.00	7,272.00		
	Besi polos	287.84	kg	3,000.00	863,520.00		
	Multipleks 15 mm (33,333%)	2.31	lbr	60,000.00	46,297.54		
	Beton Ready Mix <i>fc' 25 Mpa</i>	1.00	m ³	274,000.00	274,000.00		
	Kayu Bekisting (33,333%)	0.08	m ³	1,700,000.00	47,712.86		
	Bendrat	5.23	kg	6,500.00	34,017.10		
	Minyak bekisting	1.21	ltr	12,500.00	15,150.00		1,287,969.50
	UPAH BORONGAN						
	Cor ready mix dengan pompa	1.00	m ³	9,250.00		9,250.00	
	Buat + stel besi	287.84	kg	245.00		70,520.80	
	Bekisting	6.06	m ²	10,850.00		65,751.00	
	Pompa	1.00	m ³	8,000.00		8,000.00	
	Pasang + bongkar scaffolding	6.06	m ²	2,500.00		15,150.00	
	Scaffolding	3.00	set	16,500.00		49,500.00	218,171.80
					Jumlah		1,506,141.30
					Dibulatkan		1,506,141.00
2	PELAT P2 (3,60 x 3,60) m ²						
	BAHAN						
	Paku	1.21	kg	6,000.00	7,272.00		
	Besi polos	243.49	kg	3,000.00	730,470.00		
	Multipleks 15 mm (33,333%)	2.31	lbr	60,000.00	46,297.54		
	Beton Ready Mix <i>fc' 25 Mpa</i>	1.00	m ³	274,000.00	274,000.00		
	Kayu Bekisting (33,333%)	0.08	m ³	1,700,000.00	47,712.86		
	Bendrat	4.43	kg	6,500.00	28,776.15		
	Minyak bekisting	1.21	ltr	12,500.00	15,150.00		1,149,678.54
	UPAH BORONGAN						
	Cor ready mix dengan pompa	1.00	m ³	9,250.00		9,250.00	
	Buat + stel besi	243.49	kg	245.00		59,655.05	
	Bekisting	6.06	m ²	10,850.00		65,751.00	
	Pompa	1.00	m ³	8,000.00		8,000.00	
	Pasang + bongkar scaffolding	6.06	m ²	2,500.00		15,150.00	
	Scaffolding	3.00	set	16,500.00		49,500.00	207,306.05
					Jumlah		1,356,984.59
					Dibulatkan		1,356,985.00
3	PELAT P2 (3,60 x 1,67) m ²						
	BAHAN						
	Paku	1.13	kg	6,000.00	6,768.00		
	Besi polos	224.89	kg	3,000.00	674,667.00		
	Multipleks 15 mm (33,333%)	2.15	lbr	60,000.00	43,089.57		
	Beton Ready Mix <i>fc' 25 Mpa</i>	1.00	m ³	274,000.00	274,000.00		
	Kayu Bekisting (33,333%)	0.08	m ³	1,700,000.00	44,426.22		
	Bendrat	4.09	kg	6,500.00	26,578.50		
	Minyak bekisting	1.13	ltr	12,500.00	14,100.00		1,083,629.29
	UPAH BORONGAN						
	Cor ready mix dengan pompa	1.00	m ³	9,250.00		9,250.00	
	Buat + stel besi	224.89	kg	245.00		55,097.81	
	Bekisting	5.64	m ²	10,850.00		61,194.00	
	Pompa	1.00	m ³	8,000.00		8,000.00	
	Pasang + bongkar scaffolding	5.64	m ²	2,500.00		14,100.00	
	Scaffolding	3.00	set	16,500.00		49,500.00	197,141.81
					Jumlah		1,280,771.10
					Dibulatkan		1,280,771.00

4	PELAT P3 (1.80 x 1.80) m ²								
	BAHAN								
	Paku	1.01	kg	6,000.00	6,030.60				
	Besi polos	156.45	kg	3,000.00	469,350.00				
	Multipleks 15 mm (36,667%)	1.92	lbr	60,000.00	38,780.34				
	Beton Ready Mix <i>fc' 25 Mpa</i>	1.00	m ³	274,000.00	274,000.00				
	Kayu Bekisting (36,667%)	0.07	m ³	1,700,000.00	40,006.50				
	Bendrat	2.84	kg	6,500.00	18,489.90				
	Minyak bekisting	1.01	ltr	12,500.00	12,563.75				859,221.09
	UPAH BORONGAN								
	Cor ready mix dengan pompa	1.00	m ³	9,250.00		9,250.00			
	Buat + stel besi	156.45	kg	265.00		41,459.25			
	Bekisting	5.03	m ²	11,825.00		59,479.75			
	Pompa	1.00	m ³	8,000.00		8,000.00			
	Pasang + bongkar scaffolding	6.06	m ²	2,750.00		16,665.00			
	Scaffolding	3.00	set	16,500.00		49,500.00			184,354.00
						Jumlah			1,043,575.09
						Dibulatkan			1,043,575.00
III	PELAT ATAP								
1	PELAT PA (3.60 x 3.60) m ²								
	BAHAN								
	Paku	1.46	kg	6,000.00	8,736.00				
	Besi polos	287.83	kg	3,000.00	863,490.00				
	Multipleks 15 mm (36,667%)	2.78	lbr	60,000.00	56,176.76				
	Beton Ready Mix <i>fc' 25 Mpa</i>	1.00	m ³	274,000.00	274,000.00				
	Kayu Bekisting (36,667%)	0.10	m ³	1,700,000.00	57,920.71				
	Bendrat	5.23	kg	6,500.00	34,014.50				
	Minyak bekisting	1.46	ltr	12,500.00	18,200.00				1,312,537.96
	UPAH BORONGAN								
	Cor ready mix dengan pompa	1.00	m ³	9,250.00		9,250.00			
	Buat + stel besi	287.83	kg	285.00		82,031.55			
	Bekisting	7.28	m ²	12,800.00		93,184.00			
	Pompa	1.00	m ³	8,000.00		8,000.00			
	Pasang + bongkar scaffolding	7.28	m ²	3,050.00		22,204.00			
	Scaffolding	3.00	set	16,500.00		49,500.00			264,169.55
						Jumlah			1,576,707.51
						Dibulatkan			1,576,708.00
2	PELAT PA (3.60 x 1.67) m ²								
	BAHAN								
	Paku	1.35	kg	6,000.00	8,124.00				
	Besi polos	224.89	kg	3,000.00	674,667.00				
	Multipleks 15 mm (36,667%)	2.59	lbr	60,000.00	52,239.74				
	Beton Ready Mix <i>fc' 25 Mpa</i>	1.00	m ³	274,000.00	274,000.00				
	Kayu Bekisting (36,667%)	0.09	m ³	1,700,000.00	53,857.10				
	Bendrat	4.09	kg	6,500.00	26,578.50				
	Minyak bekisting	1.35	ltr	12,500.00	16,925.00				1,106,391.34
	UPAH BORONGAN								
	Cor ready mix dengan pompa	1.00	m ³	9,250.00		9,250.00			
	Buat + stel besi	224.89	kg	285.00		64,093.37			
	Bekisting	6.77	m ²	12,800.00		86,656.00			
	Pompa	1.00	m ³	8,000.00		8,000.00			
	Pasang + bongkar scaffolding	7.28	m ²	3,050.00		22,204.00			
	Scaffolding	3.00	set	16,500.00		49,500.00			239,703.37
						Jumlah			1,346,094.70
						Dibulatkan			1,346,095.00
3	PELAT PW (3.60 x 3.60) m ²								
	BAHAN								
	Paku	1.46	kg	4,500.00	6,552.00				
	Besi polos	319.44	kg	3,000.00	958,320.00				
	Multipleks 15 mm (36,667%)	2.78	lbr	60,000.00	56,176.76				
	Beton Ready Mix <i>fc' 25 Mpa</i>	1.00	m ³	274,000.00	274,000.00				
	Kayu Bekisting (36,667%)	0.10	m ³	1,700,000.00	57,920.71				
	Bendrat	5.81	kg	6,500.00	37,752.65				
	Minyak bekisting	1.46	ltr	8,000.00	11,648.00				1,402,370.11
	UPAH BORONGAN								
	Cor ready mix dengan pompa	1.00	m ³	9,250.00		9,250.00			
	Buat + stel besi	319.44	kg	285.00		91,040.40			
	Bekisting	7.28	m ²	12,800.00		93,184.00			
	Pompa	1.00	m ³	8,000.00		8,000.00			
	Pasang + bongkar scaffolding	7.28	m ²	3,050.00		22,204.00			
	Scaffolding	3.00	set	16,500.00		49,500.00			273,178.40
						Jumlah			1,675,548.51
						Dibulatkan			1,675,549.00

ANALISA HARGA PEKERJAAN PELAT LANTAI

No	Uraian Pekerjaan	Volume	Sat.	Harga Satuan (Rp)	Harga Tiap Pekerjaan (Rp)	Harga Total Tiap Pekerjaan (Rp)
VIII	PEKERJAAN PELAT					
I	LANTAI 2					
1	Beton pelat P1 (3,60x3,60) m ²	80.87	m ³	1,506,141.30	121,595,574.40	
2	Beton pelat P2 (3,60x3,60) m ²	68.43	m ³	1,356,984.59	92,858,455.71	
3	Beton pelat P2 (3,60x1,67) m ²	7.21	m ³	1,280,771.10	9,234,359.61	
4	Beton pelat P3 (3,60x3,60) m ²	3.11	m ³	1,030,670.22	3,205,384.38	226,893,774.10
II	LANTAI 3					
1	Beton pelat P1 (3,60x3,60) m ²	66.87	m ³	1,520,263.59	101,660,026.05	
2	Beton pelat P2 (3,60x3,60) m ²	68.43	m ³	1,370,219.89	93,764,146.85	
3	Beton pelat P2 (3,60x1,67) m ²	7.21	m ³	1,294,209.79	9,331,252.61	
4	Beton pelat P3 (3,60x3,60) m ²	3.11	m ³	1,043,575.09	3,245,518.53	208,000,944.04
III	ATAP					
1	Beton pelat PA (3,60x3,60) m ²	127.01	m ³	1,576,707.51	200,257,621.23	
2	Beton pelat PA (3,60x1,67) m ²	6.01	m ³	1,346,094.70	8,090,029.16	
3	Beton pelat PW (3,60x3,60) m ²	5.18	m ³	1,675,548.51	8,679,341.30	217,026,991.68
Harga Pekerjaan Pelat Lantai						651,921,709.83

Perhitungan Volume Beton dan Volume Bekisting Ring Balk

No	Jenis	Jumlah Tipe	Panjang Bersih (m)	Lebar Balok (m)	Tinggi Balok (m)	Volume Bekisting (m ²)	Volume Bekisting Total (m ²)	Volume Bekisting (kg)	Volume Beton (m ³)	Volume Beton Total (m ³)
a	b	c	d	e	f	$g=(c+(2*f))*d$	$h=f*g$	$i=f*g$	$j=d*e*f$	$m=f*j$
1	40/80	2	10.40	0.40	0.80	20.80	41.60	3.33	3.33	6.66
2	40/80	2	10.80	0.40	0.80	21.60	43.20	3.46	3.46	6.91
<i>Jumlah</i>						42.40	84.80	6.78	6.78	13.57

Perhitungan Kebutuhan Besi Tulangan Pokok Ring Balk

No.	Jenis	c Besi (m)	Jumlah Tulangan	Panjang Tulangan (m)	Kait (m)	Berat Besi (kg/m)	Kebutuhan Besi (m)	Berat Tulangan (kg)	Jumlah Ring Balk	Berat Total Tulangan (kg)
a	b	c	d	e	$f=5*c$	g	$h=(e+f)*d$	$i=g*h$	j	$k=i*j$
1 & 2	Tump atas	0.025	1	3.20	0.13	3.85	3.33	12.80	4	51.21
		0.025	3	3.20	0.09	3.85	9.60	36.96	4	147.84
		0.025	1	3.20	0.13	3.85	3.33	12.80	4	51.21
		0.025	3	3.20	0.00	3.85	9.60	36.96	4	147.84
	Tump bwh	0.025	3	3.90	0.00	3.85	11.70	45.05	4	180.18
	Lap atas	0.025	3	5.40	0.00	3.85	16.20	62.37	4	249.48
	Lap bawah	0.025	1	8.10	0.25	3.85	8.35	32.15	4	128.59
		0.025	3	8.10	0.00	3.85	24.30	93.56	4	374.22
	Susut	0.012	4	10.80	0.12	0.89	43.68	38.88	4	155.50
<i>Jumlah</i>								371.52		1486.06

Perhitungan Kebutuhan Besi Tulangan Begel Ring Balk

No.	Lebar Balok (m)	Tinggi Balok (m)	Panjang Balok (m)	c besi (m)	Keliling Balok (m)	Selimut Beton 5cm (m)	Kait .10 D (m)	Jarak antar Begel (m)	Berat Besi (kg/m)	Panjang 1 bh Begel (m)	Jumlah Begel	Berat Begel (kg)	Jumlah Ring Balk	Berat Total Begel (kg)
a	b	c	d	e	$f=(2*b)+(2*c)$	$g=4*0.05$	$h=2*10*c$	i	j	$k=f-g+h$	$l=(d/f)+1$	$m=j*k*l$	n	$o=m*n$
1 & 2	0.40	0.80	2.00	0.01	2.40	0.20	0.20	0.10	0.62	2.40	21.00	31.25	4.00	124.99
	0.40	0.80	8.10	0.01	2.40	0.20	0.20	0.15	0.62	2.40	55.00	81.84	4.00	327.36
<i>Jumlah</i>												113.09		452.35

Rekapitulasi Kebutuhan Besi Tulangan Ring Balk

Rekap Besi Tulangan Ulir

No	Tipe	Jenis	e Besi Ulir	Berat Tulangan (kg)	Total Berat Tul. (kg)	Volume Beton (m ³)	Konversi Tul. dlm 1m ³ Beton (kg)	Besi (koef bhnxbrt tul) (kg)	Bendrat (koef bhnxbrt tul) (kg)	
a	b	c	d	e	f = $\sum c$	g	h = (1/g) * f	i = 1.10 * h	j = 0.02 * h	
RING BALK										
1	40/80	Tump atas	0.025	12.80	332.650	3.330	99.895	109.884	1.908	
			0.025	36.96						
			0.025	12.80						
			0.025	36.96						
		Tump bwh	0.025	45.05						
			Lap atas	0.025						62.37
			Lap bwh	0.025						32.15
			0.025	93.56						
2	40/80	Tump atas	0.025	12.80	332.650	3.460	96.142	105.756	1.923	
			0.025	36.96						
			0.025	12.80						
			0.025	36.96						
		Tump bwh	0.025	45.05						
			Lap atas	0.025						62.37
			Lap bwh	0.025						32.15
			0.025	93.56						

Rekap Besi Tulangan Polos

No	Tipe	Jenis	e Besi Polos	Berat Tulangan (kg)	Total Berat Tul. (kg)	Volume Beton (m ³)	Konversi Tul. dlm 1m ³ Beton (kg)	Besi (koef bhnxbrt tul) (kg)	Bendrat (koef bhnxbrt tul) (kg)
a	b	c	d	e	f = $\sum c$	g	h = (1/g) * f	i = 1.10 * h	j = 0.02 * h
RING BALK									
1	40/80	Susut Begel	P 12	38.88	151.970	3.330	45.637	50.200	0.913
			P10-100	31.25					
			P10-150	81.84					
2	40/80	Susut Begel	P 12	38.88	151.970	3.460	43.922	48.314	0.878
			P10-100	31.25					
			P10-150	81.84					

**DAFTAR ANALISA HARGA SATUAN
PEKERJAAN RING BALK**

No	Uraian	Volume	Sat.	Harga Satuan (Rp)	Analisa Harga Bahan (Rp)	Analisa Harga Upah (Rp)	Total Harga Analisa (Rp)
IX	PEKERJAAN BETON RING BALK						
1	RING BALK (40/80)						
	BAHAN						
	Paku	1.25	kg	6,000.00	7,500.00		
	Besi ulir	109.88	kg	3,350.00	368,111.40		
	Besi polos	50.20	kg	3,000.00	150,600.00		
	Multipleks 15 mm (50%)	2.39	lbr	60,000.00	71,625.00		
	Beton Ready Mix <i>fc' 25 Mpa</i>	1.00	m ³	274,000.00	274,000.00		
	Kayu Bekisting (50%)	0.09	m ³	1,700,000.00	73,865.00		
	Bendrat	2.91	kg	6,500.00	18,921.50		
	Minyak bekisting	1.25	ltr	12,500.00	15,625.00		980,247.90
	UPAH BORONGAN						
	Cor ready mix dengan pompa	1.00	m ³	9,250.00		9,250.00	
	Buat + stel besi	160.08	kg	245.00		39,220.58	
	Bekisting	6.25	m ²	12,800.00		80,000.00	
	Pompa	1.00	m ³	8,000.00		8,000.00	
	Pasang + bongkar scaffolding	6.25	m ²	3,350.00		20,937.50	
	Scaffolding	3.00	set	19,500.00		58,500.00	215,908.08
					Jumlah		1,196,155.98
					Dibulatkan		1,196,156.00
2	RING BALK (40/80)						
	BAHAN						
	Paku	1.25	kg	6,000.00	7,500.00		
	Besi ulir	105.76	kg	3,350.00	354,282.60		
	Besi polos	48.31	kg	3,000.00	144,942.00		
	Multipleks 15 mm (50%)	2.39	lbr	60,000.00	71,625.00		
	Beton Ready Mix <i>fc' 25 Mpa</i>	1.00	m ³	274,000.00	274,000.00		
	Kayu Bekisting (50%)	0.09	m ³	1,700,000.00	73,865.00		
	Bendrat	2.80	kg	6,500.00	18,206.50		
	Minyak bekisting	1.04	ltr	12,500.00	12,950.00		957,371.10
	UPAH BORONGAN						
	Cor ready mix dengan pompa	1.00	m ³	9,250.00		9,250.00	
	Buat + stel besi	154.07	kg	245.00		37,747.15	
	Bekisting	6.25	m ²	12,800.00		80,000.00	
	Pompa	1.00	m ³	8,000.00		8,000.00	
	Pasang + bongkar scaffolding	6.25	m ²	3,350.00		20,937.50	
	Scaffolding	3.00	set	19,500.00		58,500.00	214,434.65
					Jumlah		1,171,805.75
					Dibulatkan		1,171,806.00

ANALISA HARGA PEKERJAAN RING BALK

No	Uraian Pekerjaan	Volume	Sat.	Harga Satuan (Rp)	Harga Tiap Pekerjaan (Rp)	Harga Total Tiap Pekerjaan (Rp)
IX	PEKERJAAN RING BALK					
1	Beton ring balk (40/80)	6.66	m ³	1,196,155.98	8,009,345.08	
2	Beton ring balk (40/80)	6.91	m ³	1,171,805.75	8,097,177.73	16,106,522.81
Harga Pekerjaan Ring Balk						16,106,522.81

HARGA SATUAN UPAH BORONGAN PEKERJAAN

No	Macam Pekerjaan	Sat	Harga (Rp)
I	PEKERJAAN PONDASI		
1	Urugan	m ³	5.500,-
2	Pemancangan	m'	25.000,-
II	PEKERJAAN BETON BERTULANG		
A	PEMBESIAN		
	<i>Pembesian Non Pelat</i>		
1	Poer pile dan sloof	kg	200,-
2	Lantai 1	kg	200,-
3	Lantai 2	kg	215,-
4	Lantai 3	kg	230,-
5	Atap	kg	245,-
	<i>Pembesian Pelat</i>		
1	Lantai 1	kg	225,-
2	Lantai 2	kg	245,-
3	Lantai 3	kg	265,-
4	Atap	kg	285,-
B	BEKISTING		
1	Pondasi :		
	- Poer pile (pasangan batako)	m ²	4.500,-
	- Sloof	m ²	9.000,-
2	Lantai 1 :		
	- Kolom	m ²	9.250,-
3	Lantai 2 :		
	- Kolom	m ²	10.175,-
	- Pelat dan balok	m ²	10.850,-
4	Lantai 3 :		
	- Kolom	m ²	11.100,-
	- Pelat dan balok	m ²	11.825,-
5	Atap :		
	- Kolom	m ²	12.025,-
	- Pelat dan balok	m ²	12.800,-
	- Ring balk	m ²	12.800,-
C	COR		
1	Poer pile dan sloof :		
	- Cor ready mix tanpa pompa (termasuk perawatan)	m ³	32.500,-

2	Pelat Lantai dan Balok :		
	a. Lantai 2 :		
	- Cor ready mix dengan pompa (termasuk perawatan)	m ³	9.250,-
	b. Lantai 3 :		
	- Cor ready mix dengan pompa (termasuk perawatan)	m ³	9.250,-
	c. Atap :		
	- Cor ready mix dengan pompa (termasuk perawatan)	m ³	9.250,-
3	Kolom dan Tangga :		
	a. Lantai 1 :		
	- Cor ready mix tanpa pompa (termasuk perawatan)	m ³	40.000,-
	b. Lantai 2 :		
	- Cor ready mix tanpa pompa (termasuk perawatan)	m ³	41.500,-
	c. Lantai 3 :		
	- Cor ready mix tanpa pompa (termasuk perawatan)	m ³	43.000,-
	d. Atap :		
	- Cor ready mix tanpa pompa (termasuk perawatan)	m ³	44.500,-

Sumber : Wawancara Tim Perencana proyek, 2004.