

LAMPIRAN

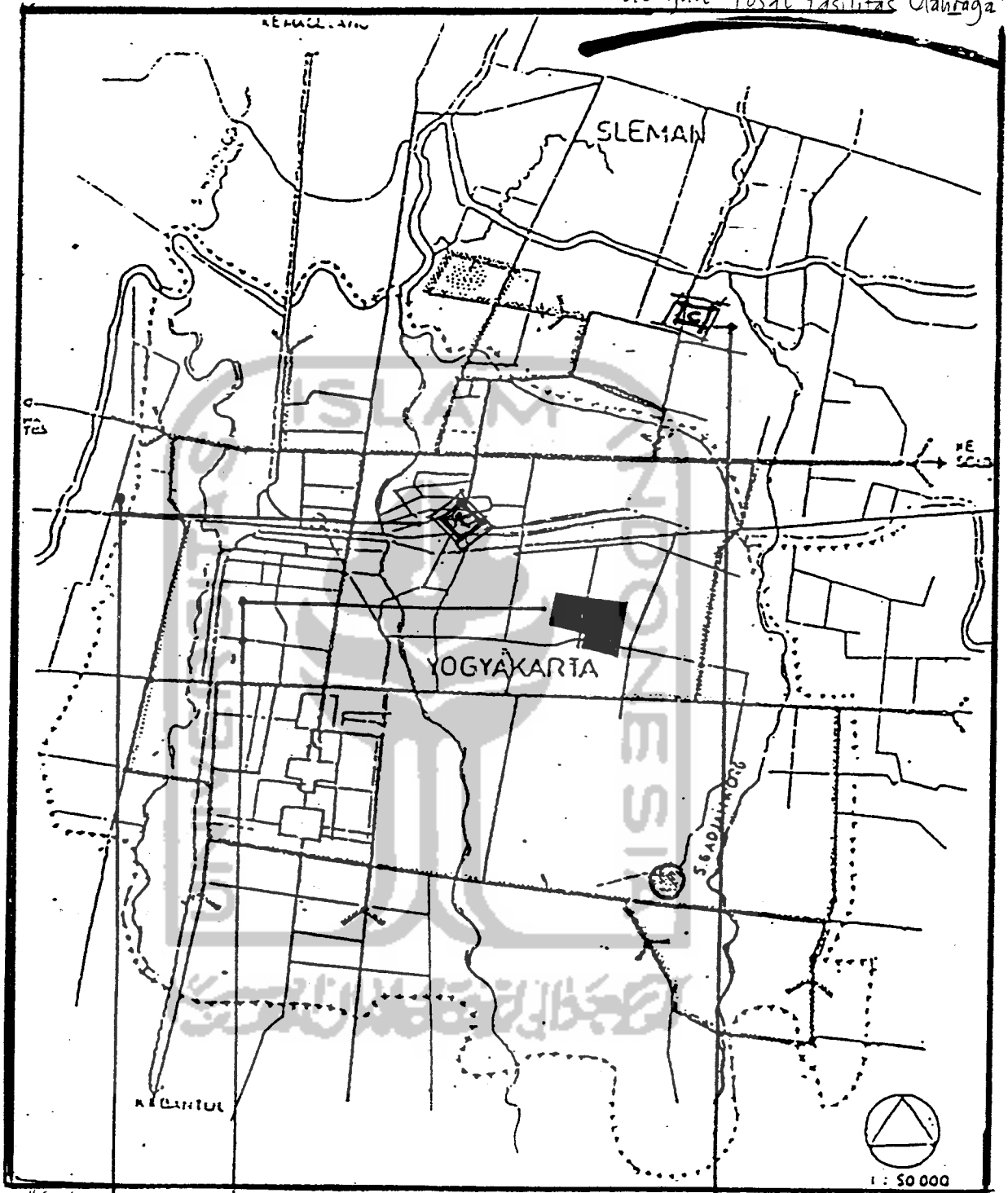

'Kawasan Jogja'
dengan 'Pusat Fasilitas Olahraga'



Keterangan Fasilitas Pendukung

- - Pusat Fasilitas Olahraga
- ⊠ = Stadion Kridasana dikembangkan sebagai kegiatan olahraga luar ruangan
- ⊙ = Transportasi (pendukung)
 - Terminal
 - Stasiun
 - Bandara
- ⊠ = Komplek Colombo dikembangkan sebagai SDP untuk tenis terlampir

Kawasan Yogya
dengan Pusat Fasilitas Olahraga

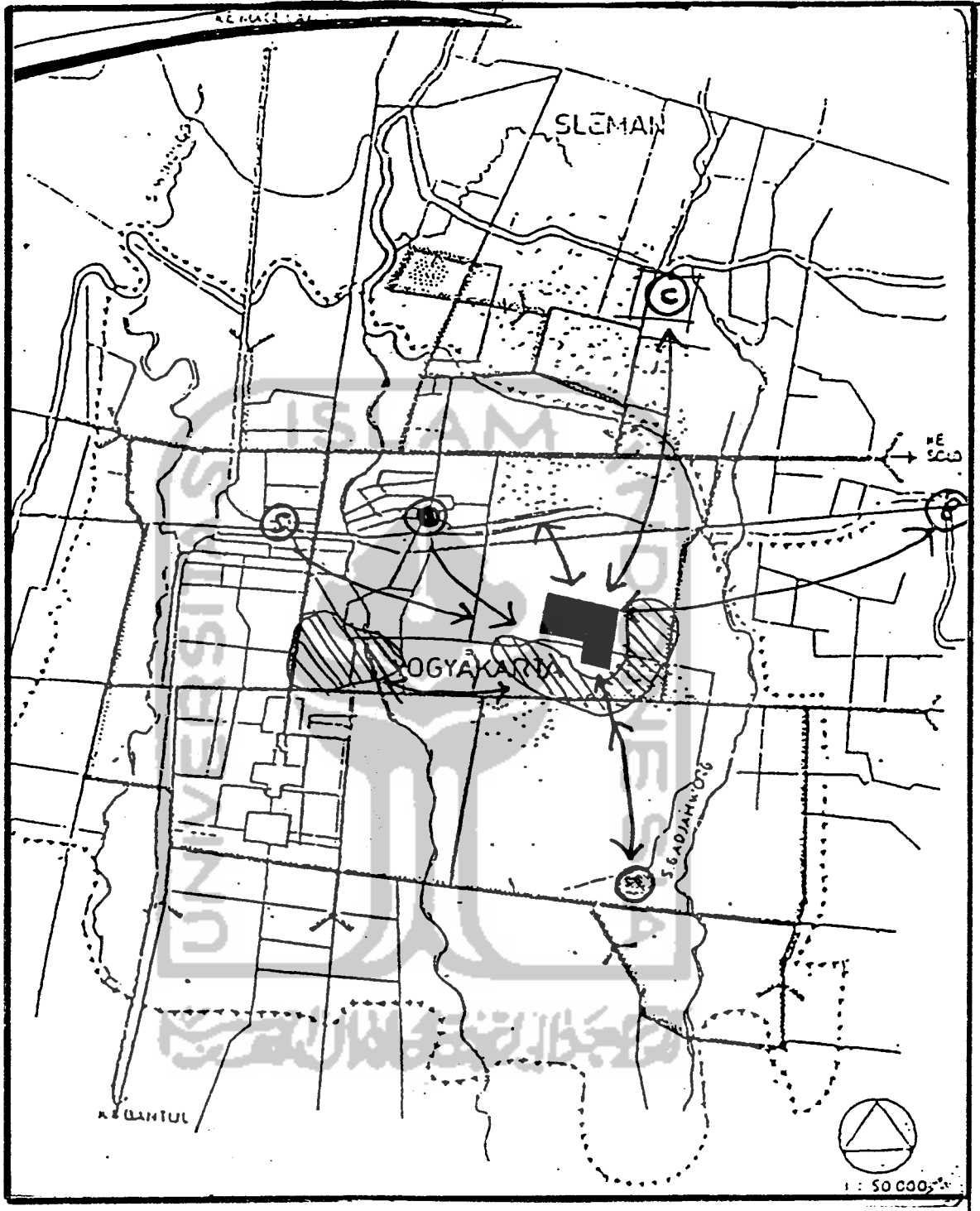

- | | | | |
|---|--------------|---|-------------------|
| ⊙ | - terminal | ▨ | - Perkantoran |
| ⊗ | - Kridosono | ⊞ | - Hunian |
| ⊙ | - Stasiun | ⊙ | - Komplek Colombo |
| ⊙ | - Bandara | | |
| ⊙ | - Pendidikan | | |

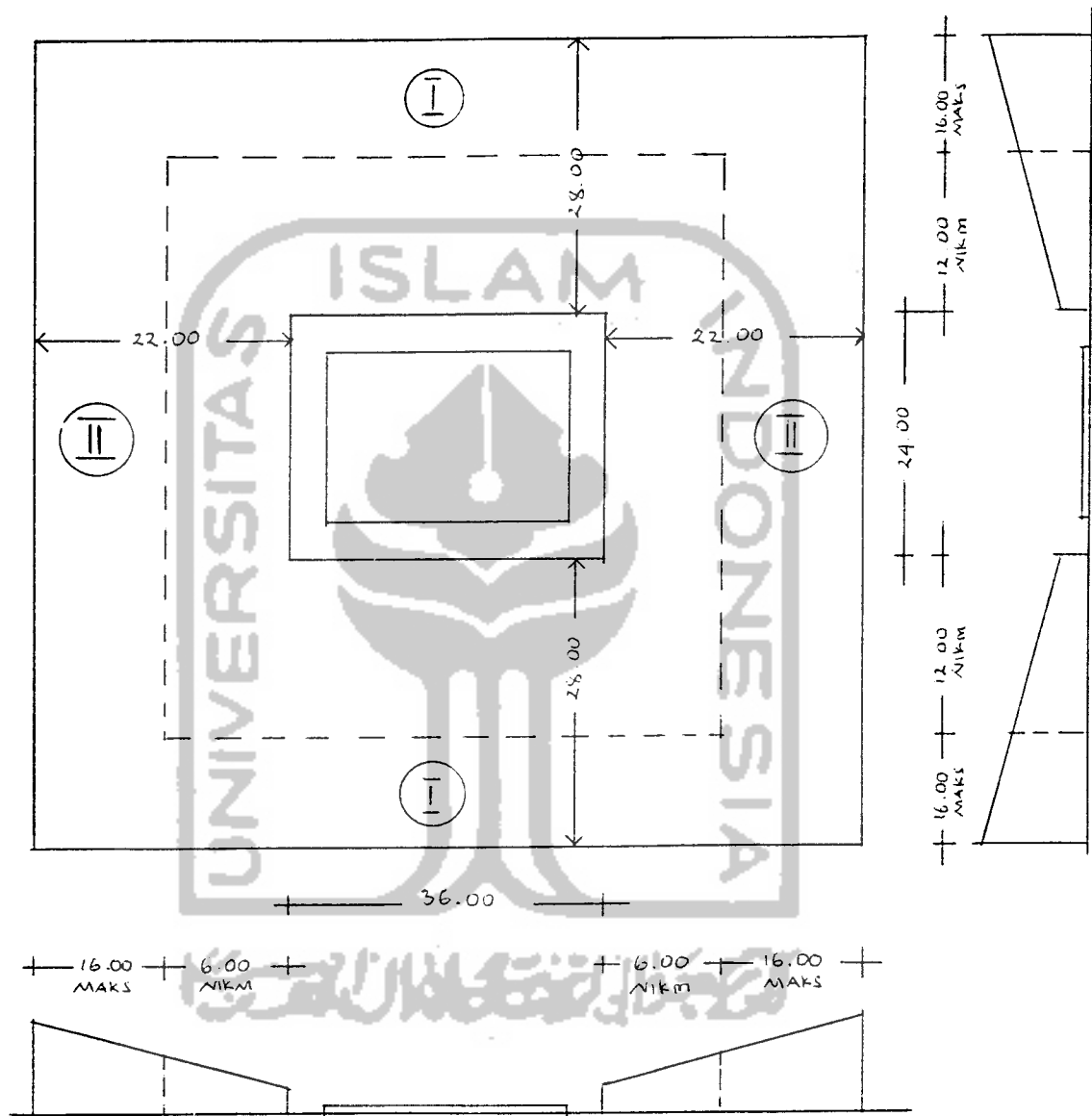

Sketsa Tata Letak
 Arena + audience
 Gedung Olahraga [indoor]

Lap. Bola Basket

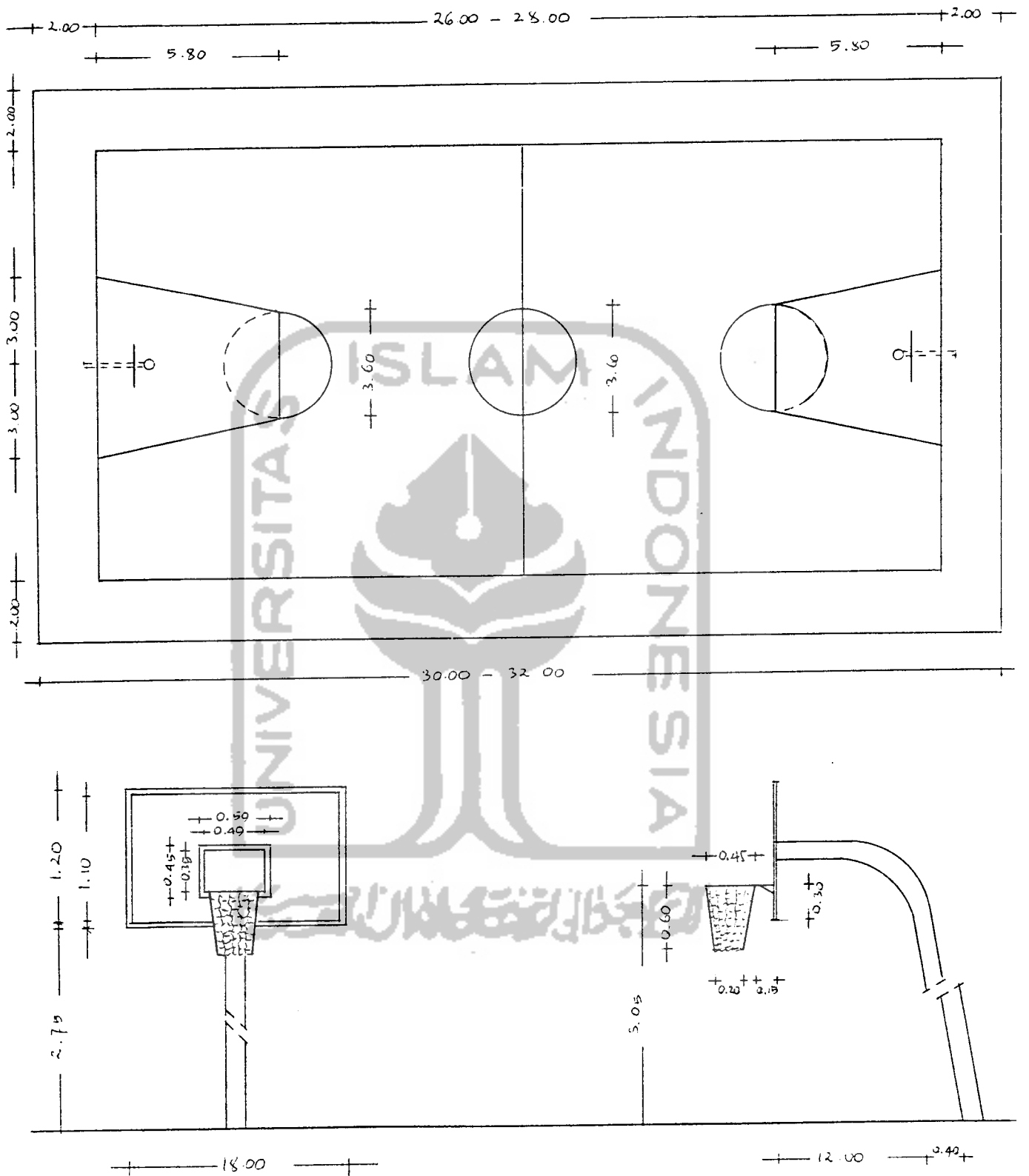

Standar Fasilitas OR
 PID KONI PUSAT JKT.

Lap. Bola Volley

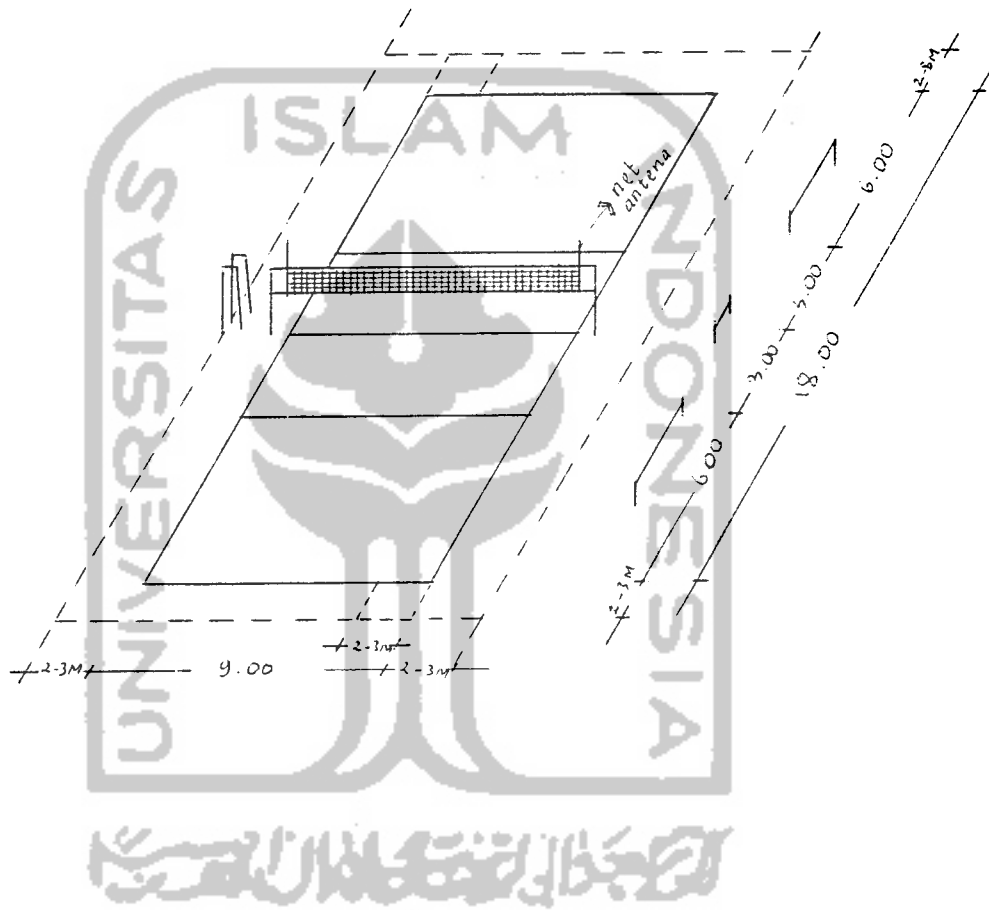

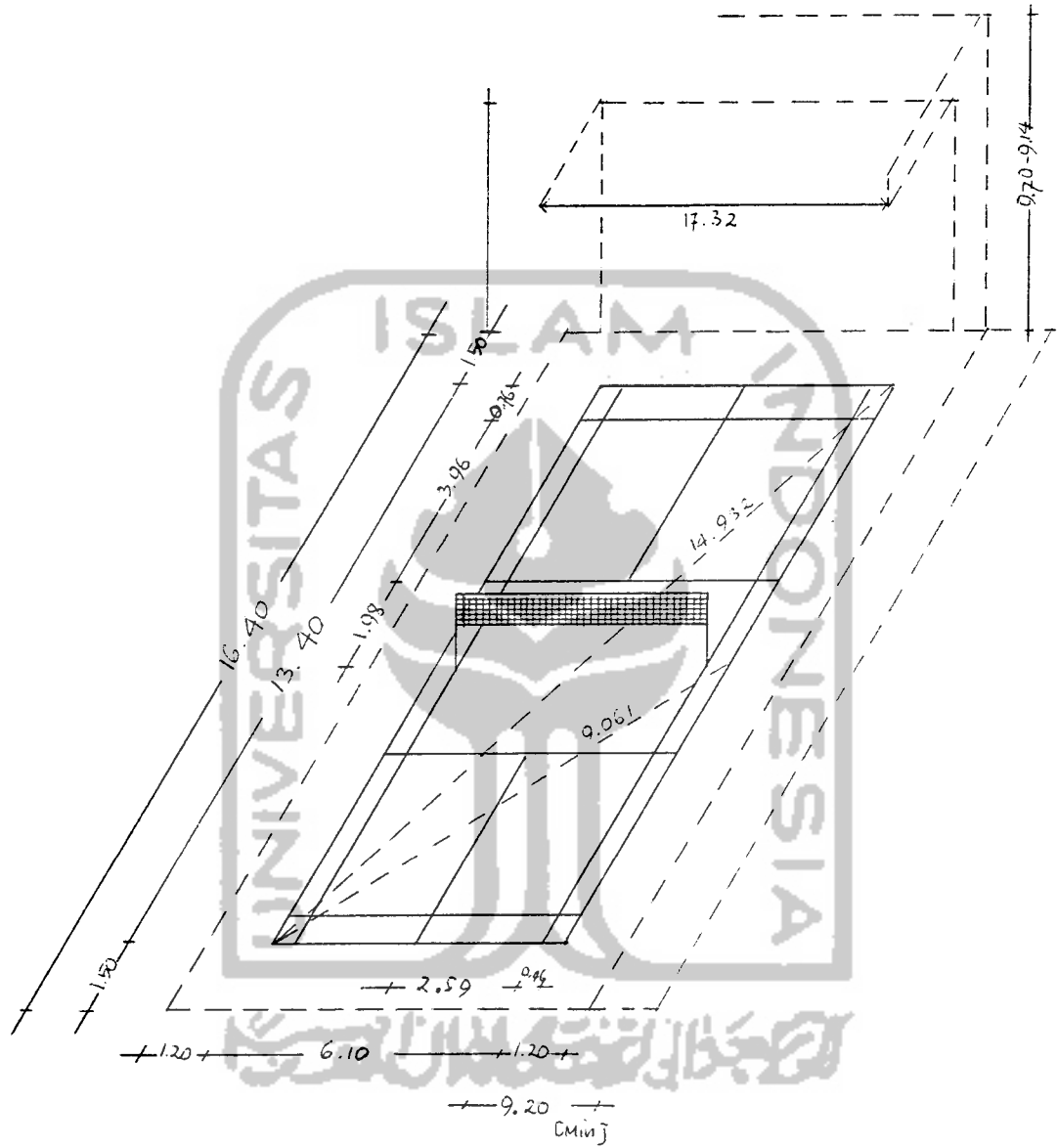

Standar Fasilitas OR PIO KUN1
PUSAT JKT.

Lap. Bulu Tangkis

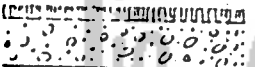
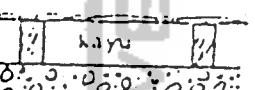

Standar Fasilitas OR
PIO KONI PUSAT JKT.

TABEL : CABANG OLIMPIKA DAN KONSTRUKSI LANTAI YANG SESUAI.

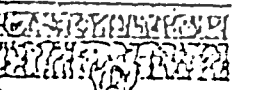
JENIS / KONSTRUKSI LANTAI ATAS ATAU LANTAI	CABANG OLIMPIKA						
	sepak bola	badminton	bulu tangkis	tenis	senam	atletik	
Pasir atau tanpa pasir 	-	×	○	●	○	×	
Bahan sintetis 	●	●	●	●	●	●	
Kayu 	-	●	●	●	●	×	
Karpet 	●	-	-	●	-	●	
Gravel/tanah stabilisasi 	○	●	-	●	-	●	



BAIK



BURUK



TIDAK BOLEH DICUKANAH

- Dengan sepatu yang cocok
 = Lantai dilapisi/ditutupi karpet.

➤ Alternatif Penggunaan Konstruksi Lantai

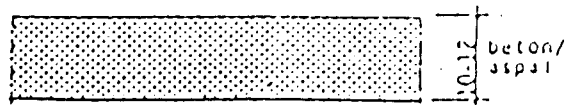

Gb. KONSTRUKSI KAKU

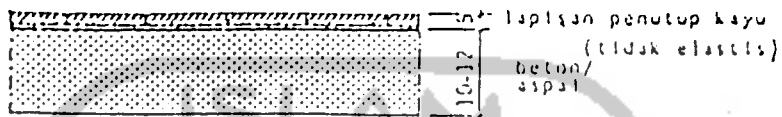

Gb. KONSTRUKSI KAKU DENGAN PENUTUP KAYU

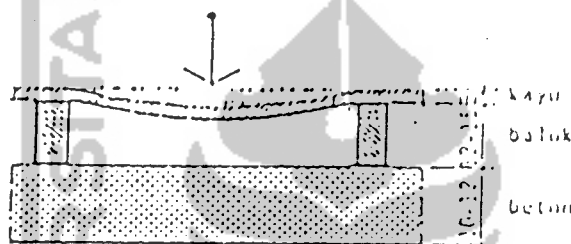

Gb. KONSTRUKSI FLEKSIBLE

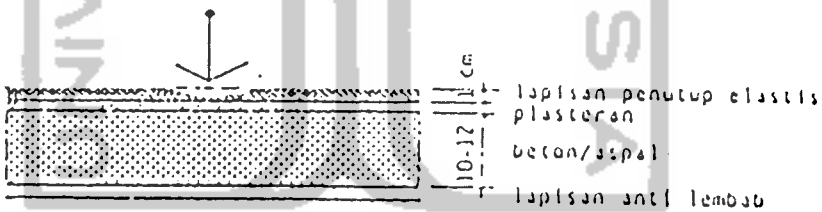

Gb. KONSTRUKSI ELASTIS TIDAK FLEKSIBLE

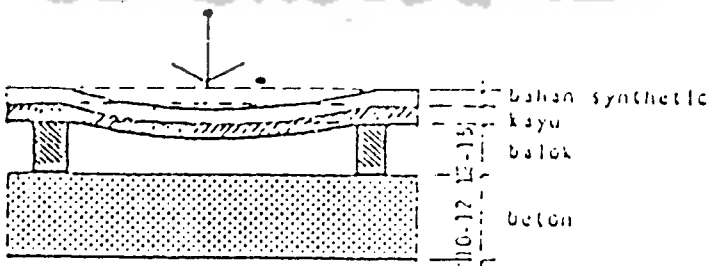

Gb. KONSTRUKSI ELASTIS FLEKSIBLE

✎ Konstruksi Lantai
Arena Gedung Olahraga

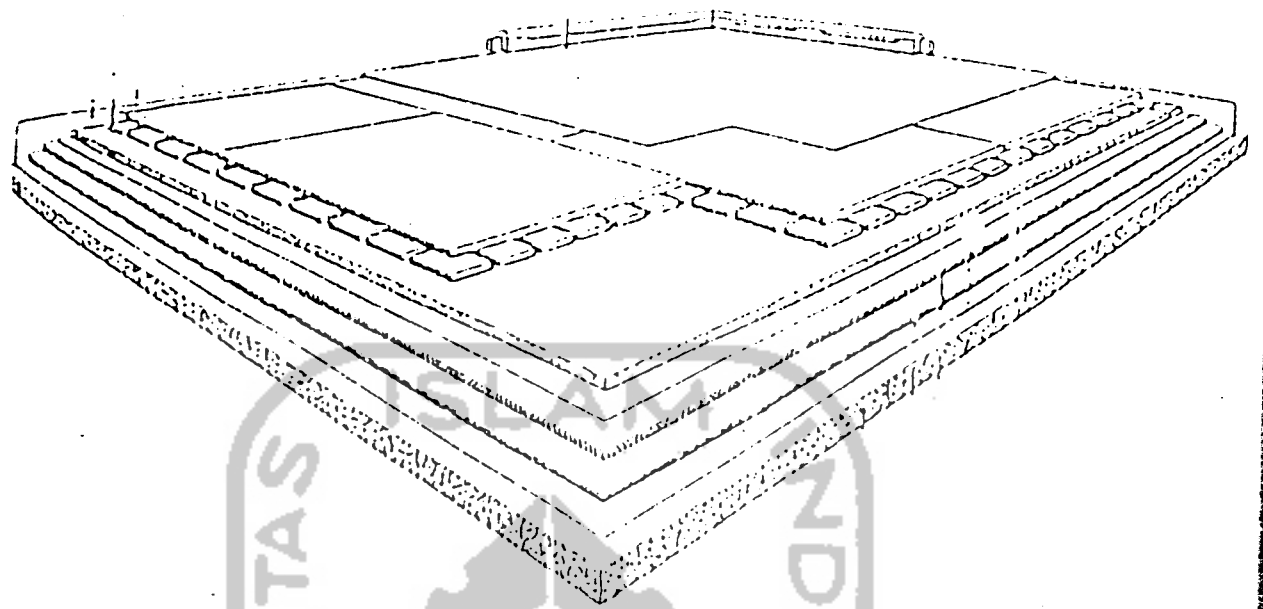

CONTOH :
KONST. LANTAI ELASTIS

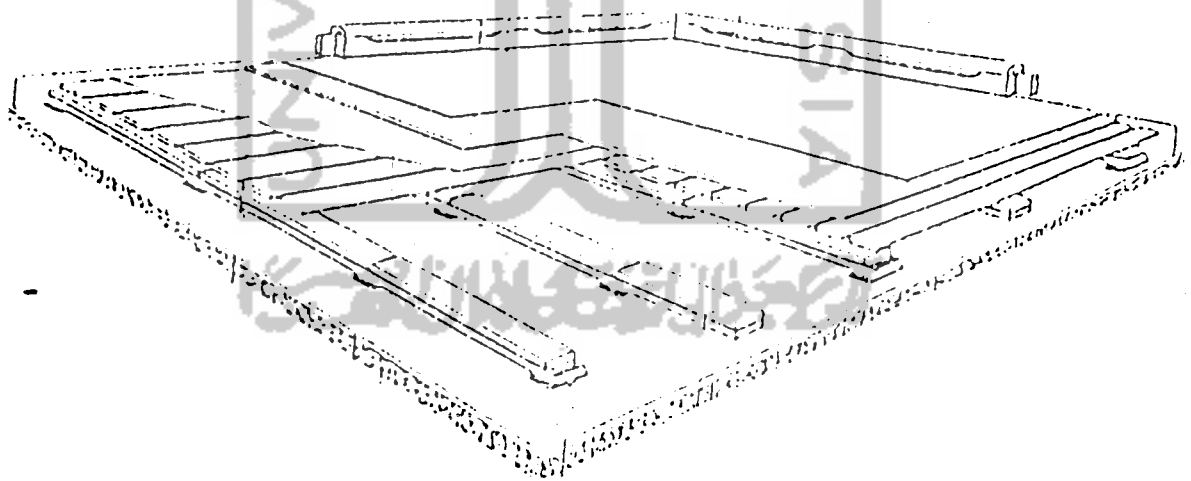

CONTOH :
KONST. LANTAI ELASTIS - FLEKTIBEL

➤ Konstruksi Lantai
Arena Gedung Clabraga

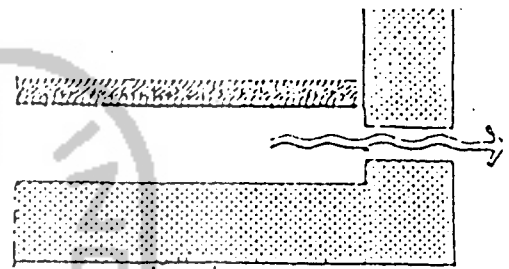
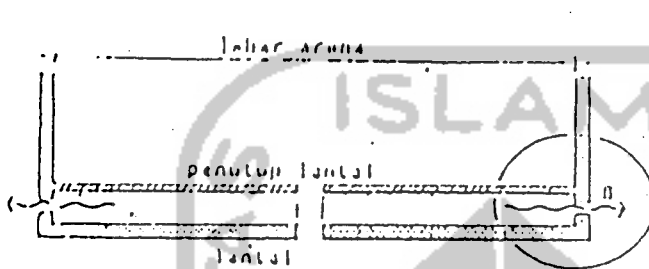
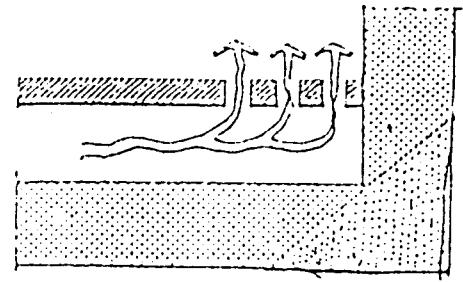
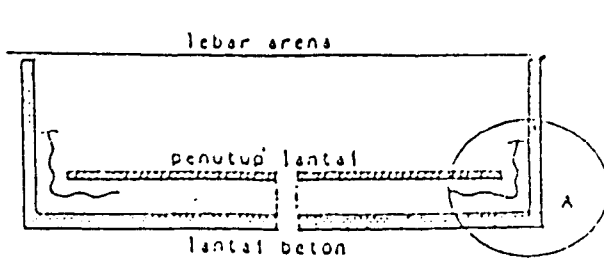

DETAIL B.
(ALTERNATIF VENTILASI)

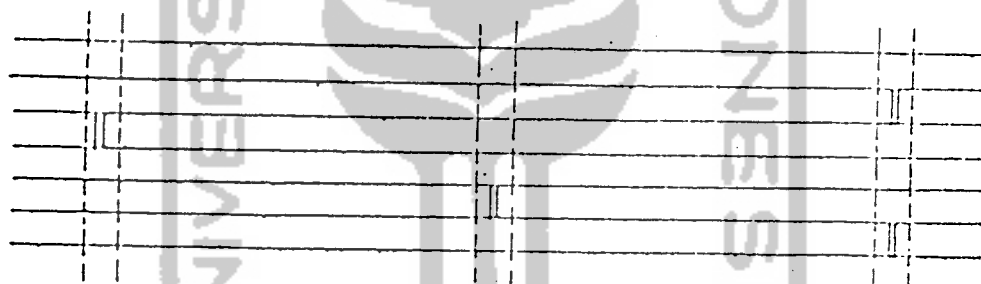

SAMBUNGAN PAPAN LANTAI TIDAK BOLEH DALAM SATU GARIS.

SAMBUNGAN LANTAI

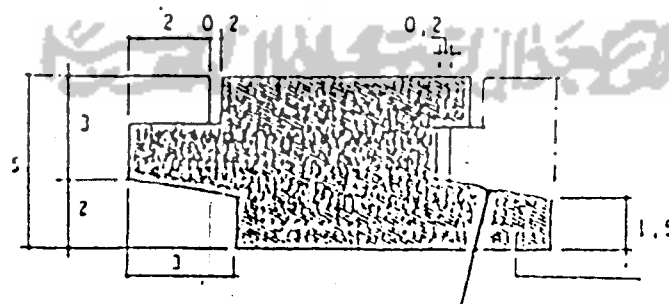

Gb. CONTOH DETAIL SAMBUNGAN LANTAI.

↳ Konstruksi Lantai
Arena Gedung Olahraga