

SURAKARTA

B. PERMAINAN MUSIK PETIK

GUITAR

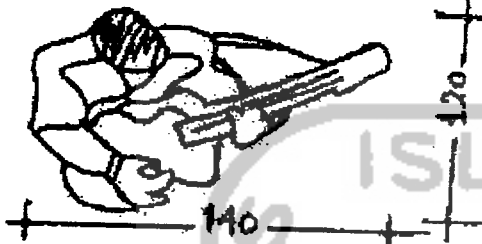

$a = 1,74m^2$

HARPA

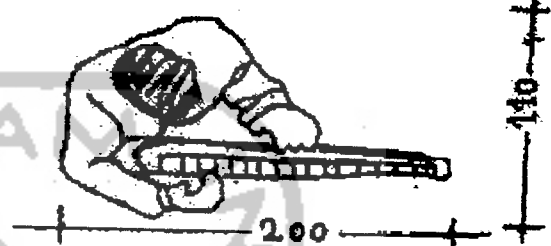

$A = 2,24m^2$

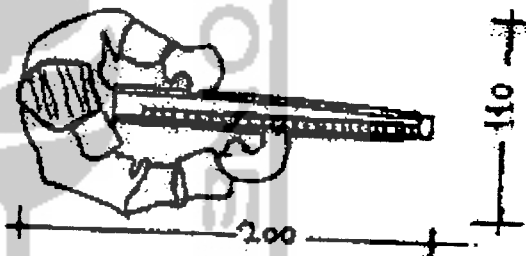
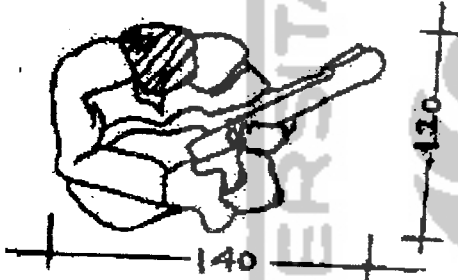

C. PERMAINAN MUSIK PERKUSI

DRUM

DRUM LENGKAP

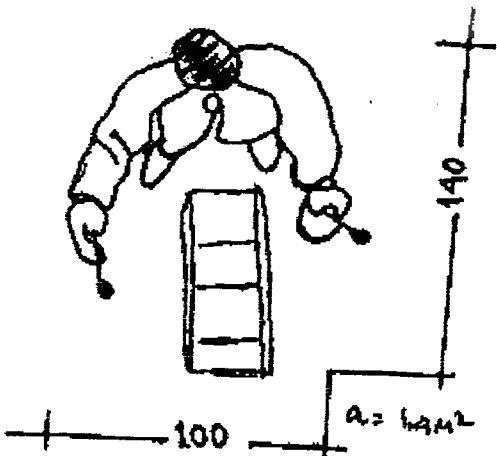

$a = 1,4m^2$

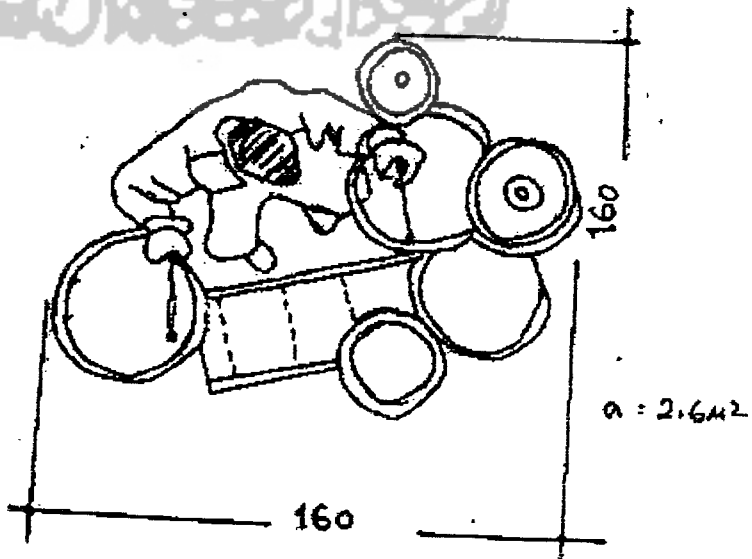

$a = 2,64m^2$

Besaran Ruang Perangkat Ganelag Jawa:

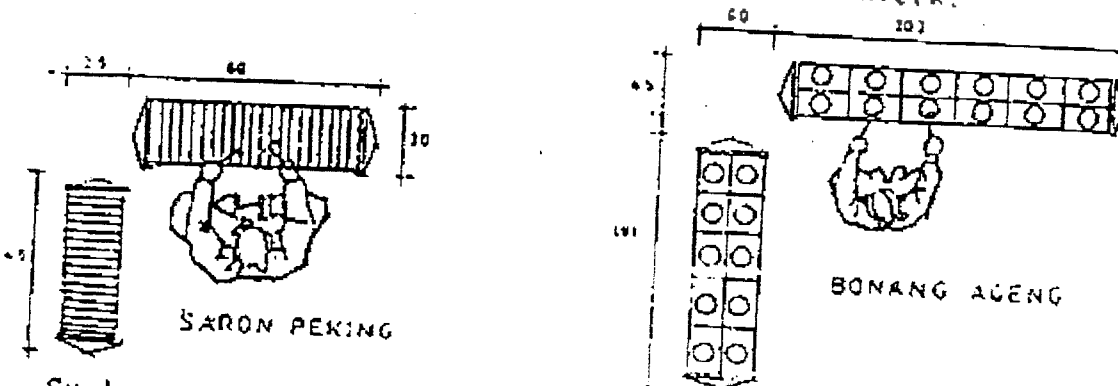
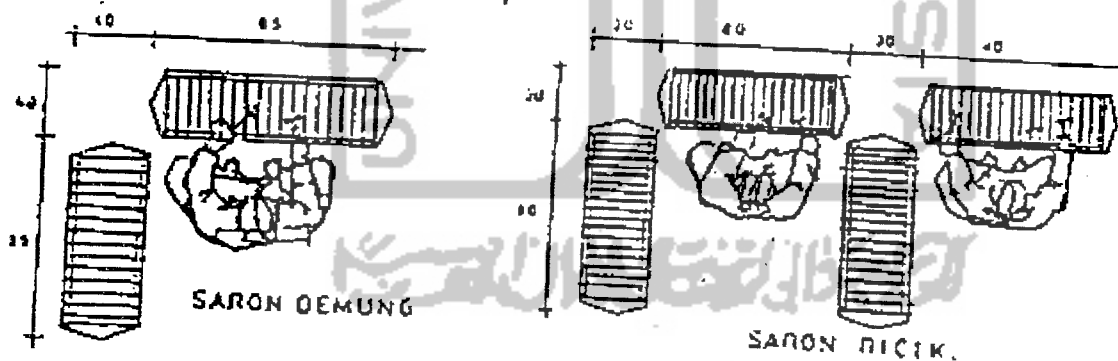
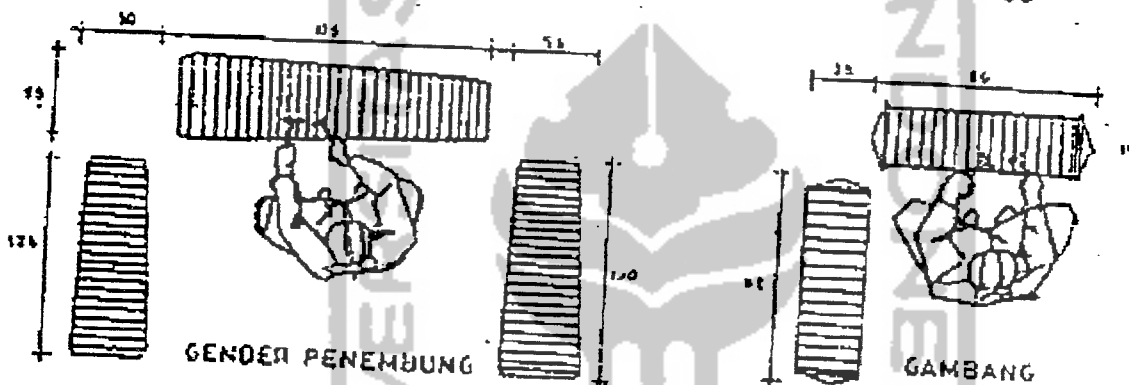
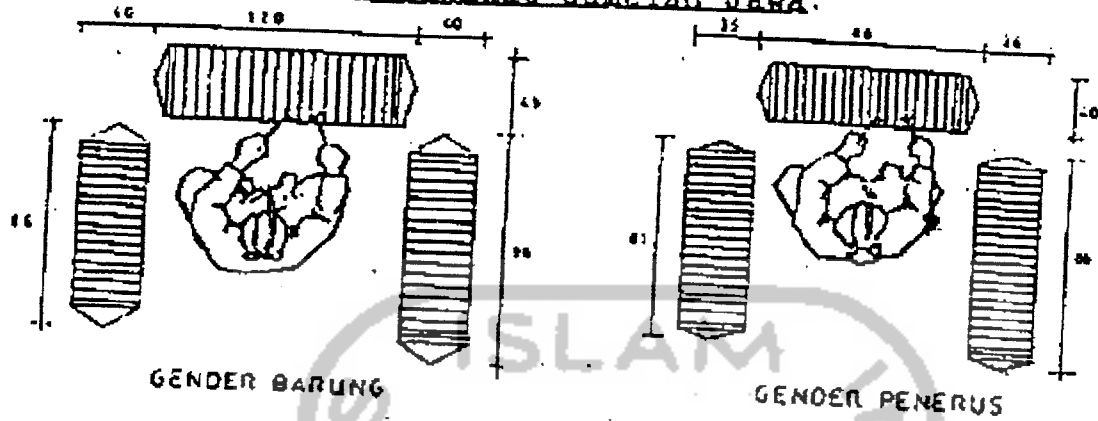

Sumber:

BIOLA



CELLO

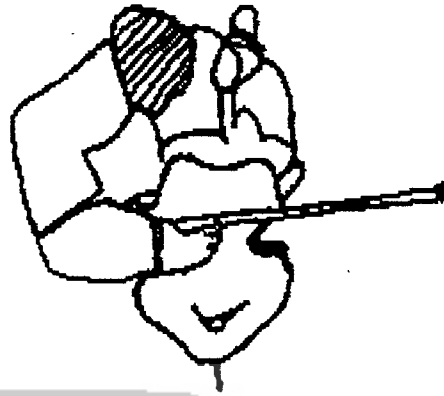

$$a = 1,2 \text{ m}^2$$

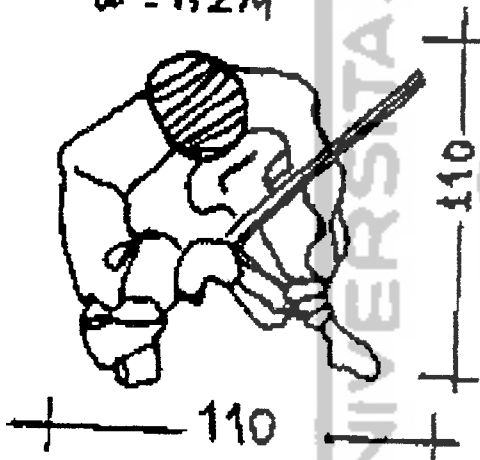

$$a = 1,4 \text{ m}^2$$

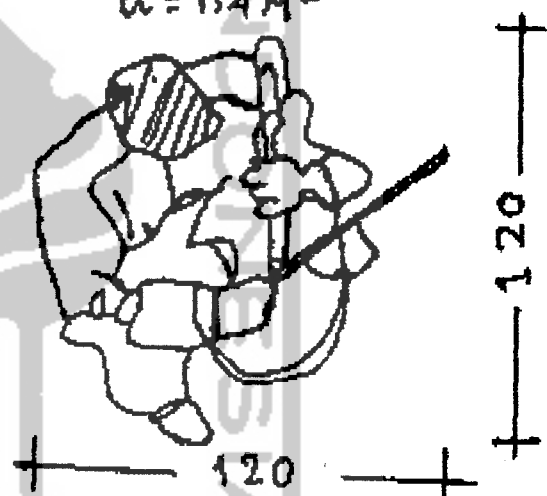

BASS GESEK

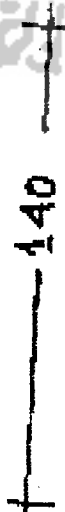
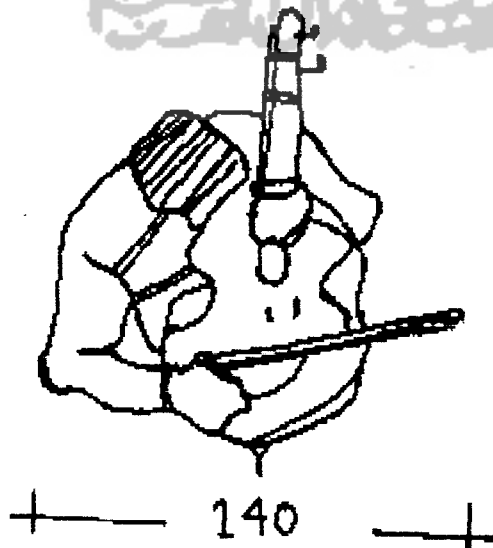

$$a = 2,0 \text{ m}^2$$

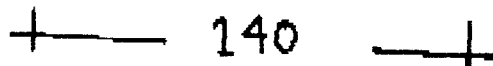

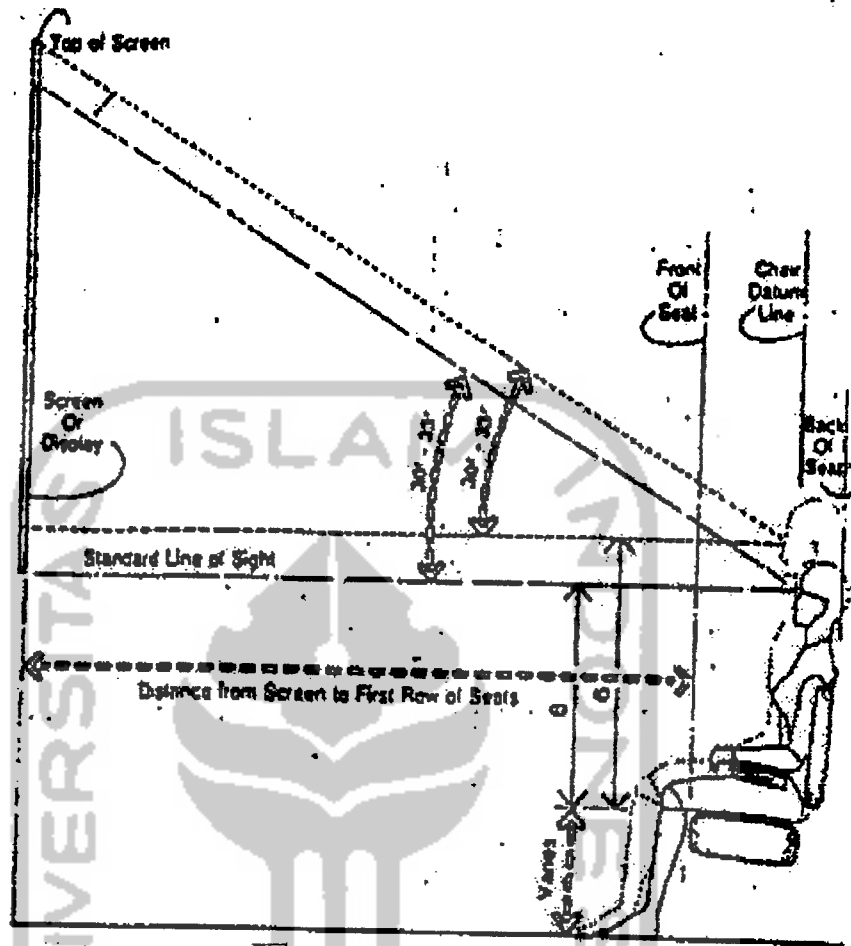

DISTANCE FROM SCREEN TO FIRST ROW

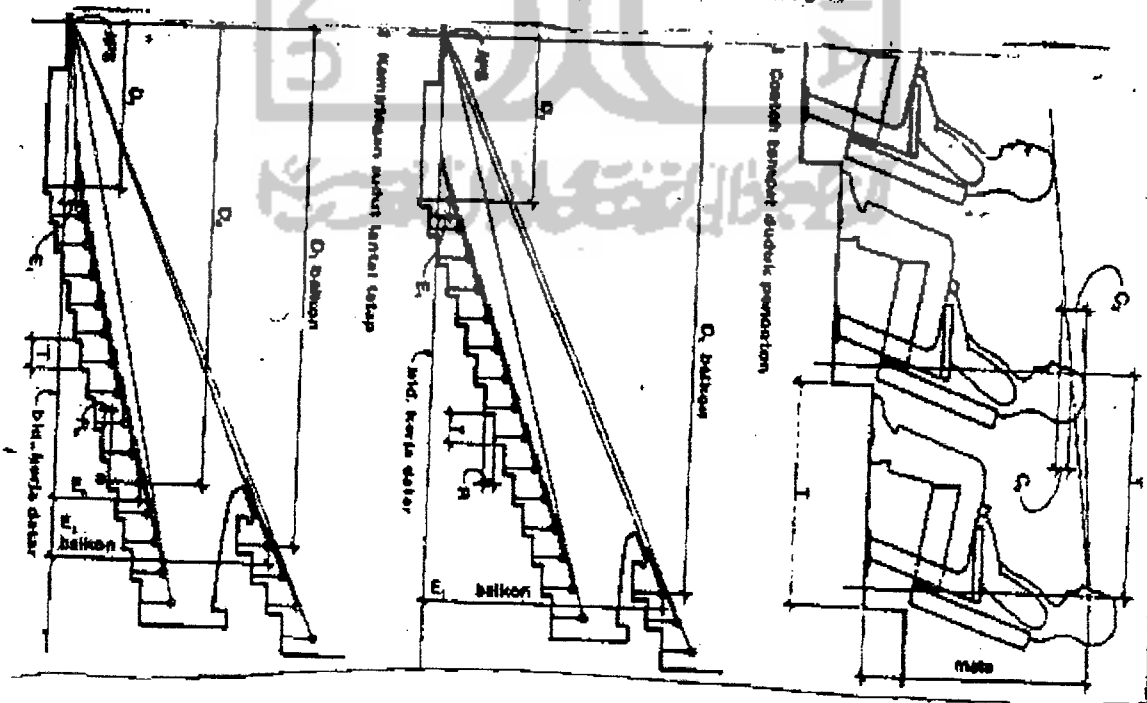

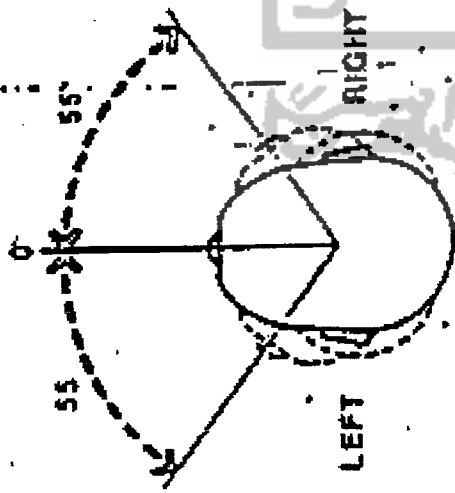

ROTATION

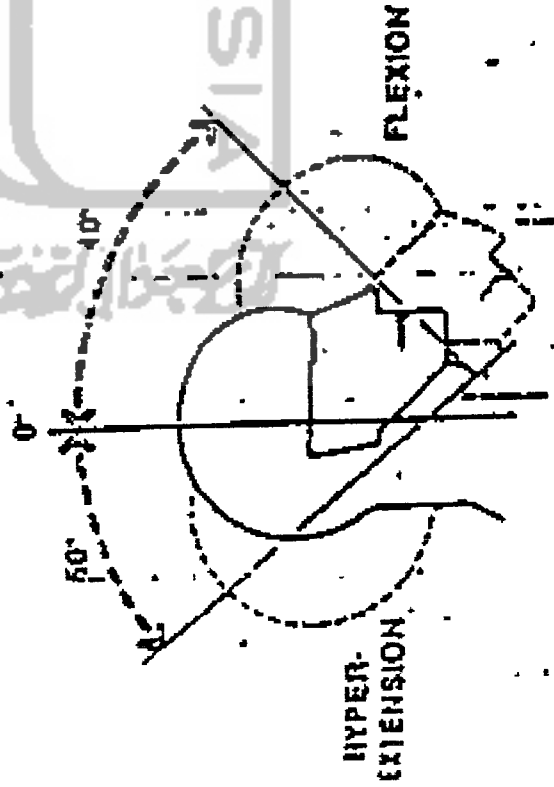

HYPEREXTENSION AND FLEXION

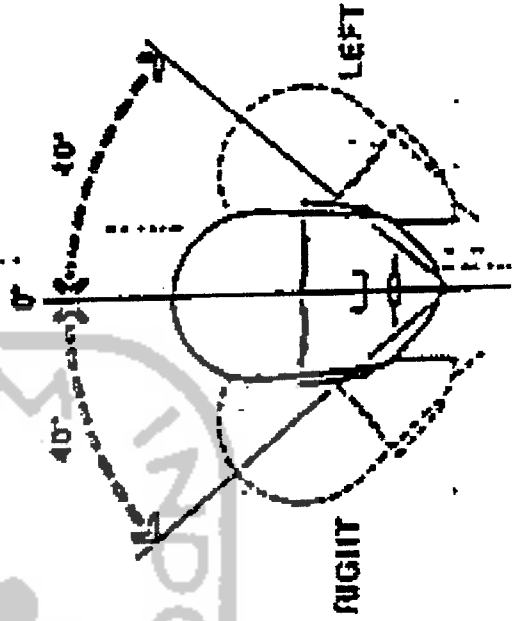

LATERAL BENDING

