

[0,15 : 1]

	Skala :	Nama : Agus Surachman	Keterangan
	Satuan : mm	NIM : 14525011	
	Tanggal :	Diperiksa : Arif Budi Wicaksono, S.T., M.Eng	MOLD UNIT
		GRID RUNNER SYSTEM	

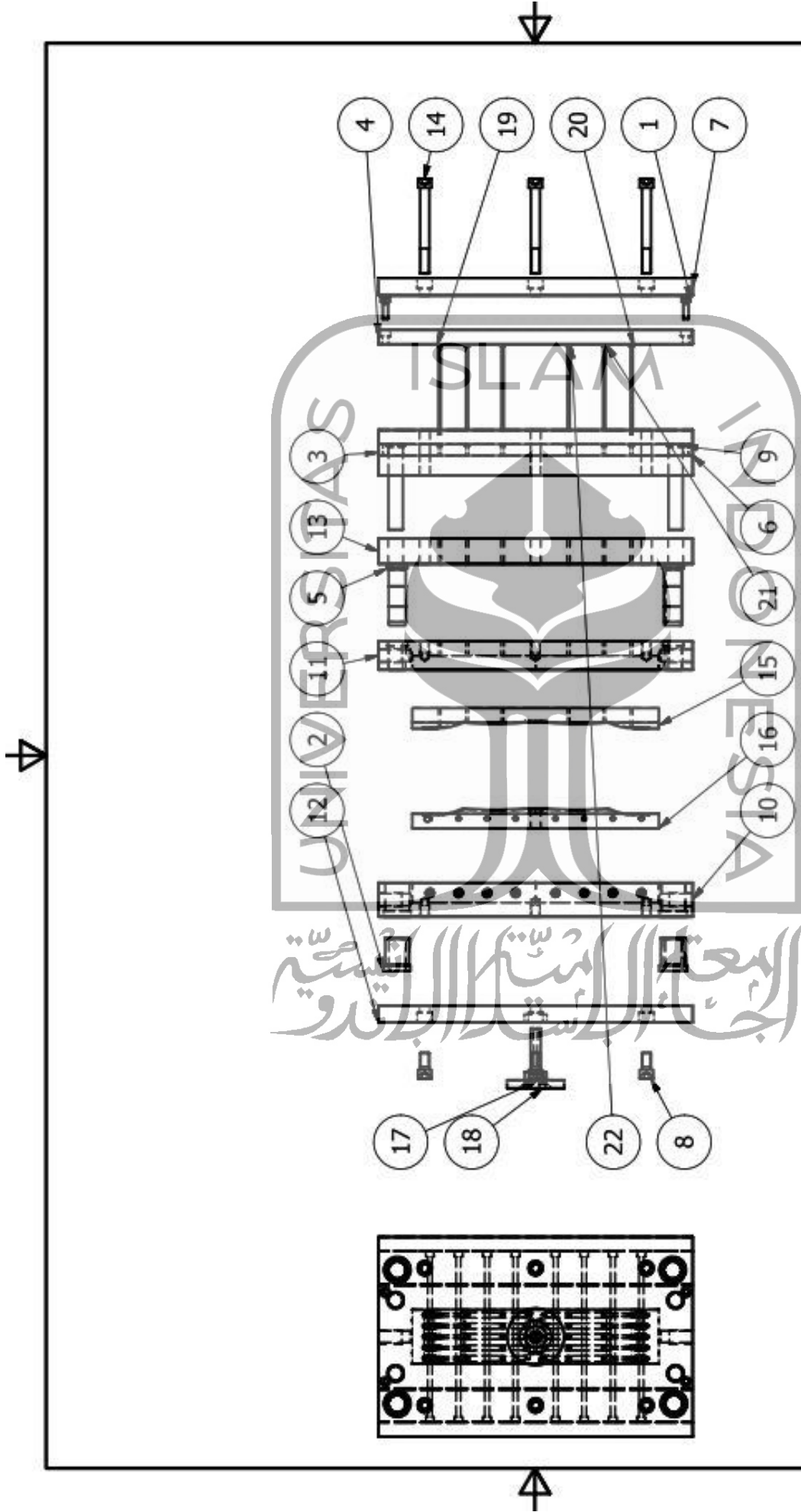



	Skala : 1:9	Nama : Agus Surachman	Keterangan
	Satuan : mm	NIM : 14525011	
	Tanggal :	Diperiksa : Arif Budi Wicaksono , S.T., M.Eng	
TEKNIK MESIN FTI UII		BALLON MOLD UNIT GRID RUNNER SYSTEM	
			A4



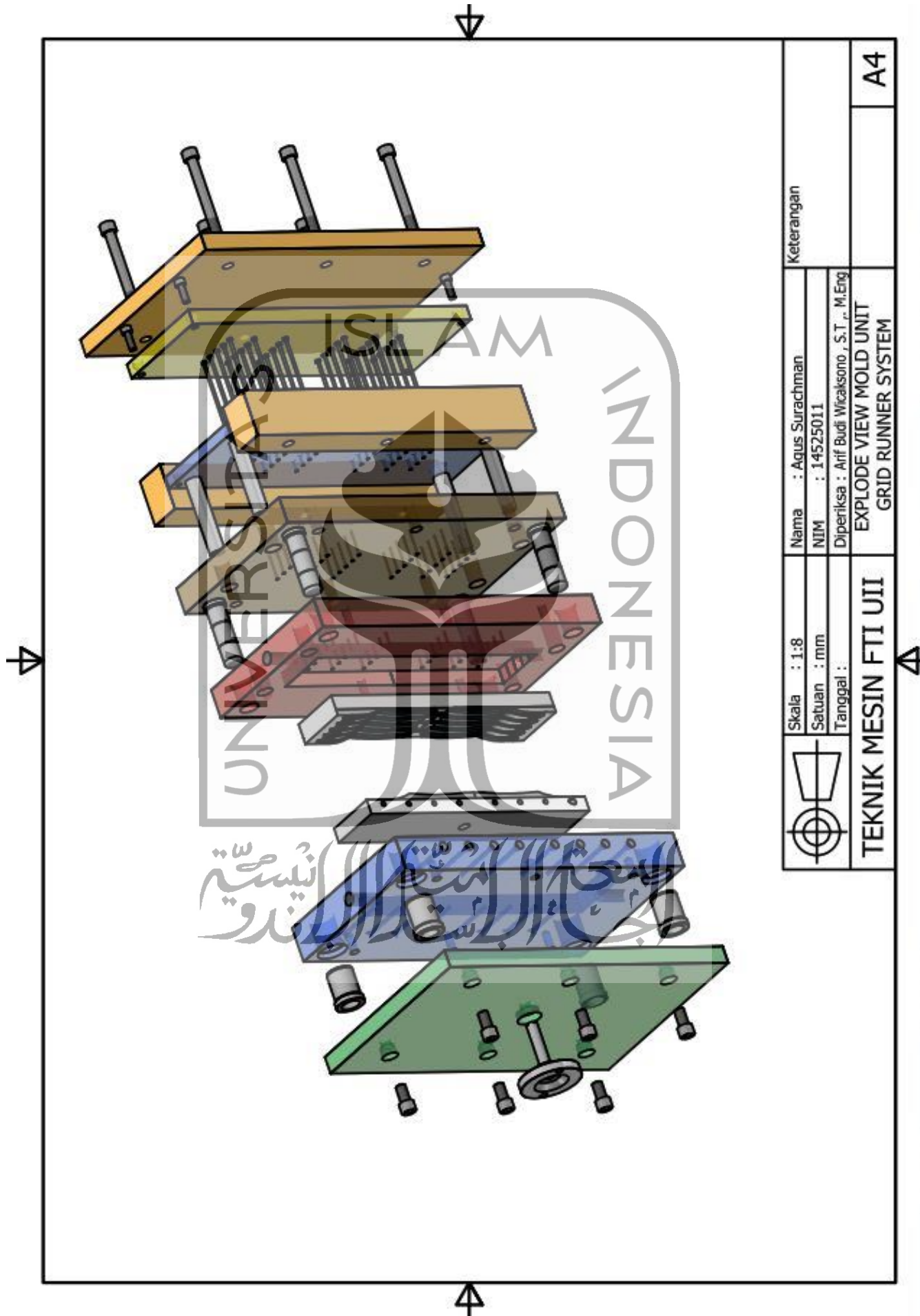

PARTS LIST			
ITEM	QTY	PART NUMBER	DESCRIPTION
1	4	JIS 1176 M10x30	Cylinder Head Cap Screw
2	4	M-GBA 30x59	GUIDE BUSH
3	2	SA-SB-550x300x80	Spacer Block
4	1	SA-EP-550x180x25	Ejector Plate
5	4	M-GPA30x107x49	GUIDE PIN
6	1	SA-ERP-550x180x20	Ejector Retainer Plate
7	1	SA-BCP-550x350x30x24 0	Bottom Clamping Plate
8	6	JIS 1176 M16x30	Cylinder Head Cap Screw
9	4	M-RPN25x150	Return Pin
10	1	SA-S-AP-550x300x60	Cavity Plate
11	1	SA-S-BP-550x300x50	Core Plate
12	1	SA-TCP-550x350x30x24 0	Top Clamping Plate
13	1	SA-SP-550x300x45	Support Plate
14	6	JIS 1176 M16x150	Cylinder Head Cap Screw
15	1	Mold design sikat gigi_Combined CR1	
16	1	Mold design sikat gigi_Combined CV1	
17	1	Z51/18x76/3.5/15.5	Sprue Bushing
18	1	LR-100-36	Locating Ring
19	15	AH 4 -160	Ejector pins-hardened
20	5	Mold design sikat gigi_sigi new1 4mm modified3_EP Group1_EP6_MIR	Ejector pins-hardened
21	5	Mold design sikat gigi_sigi new1 4mm modified3_EP Group1_EP5_MIR	Ejector pins-hardened
22	5	Mold design sikat gigi_sigi new1 4mm modified3_EP Group1_EP1_MIR	Ejector pins-hardened





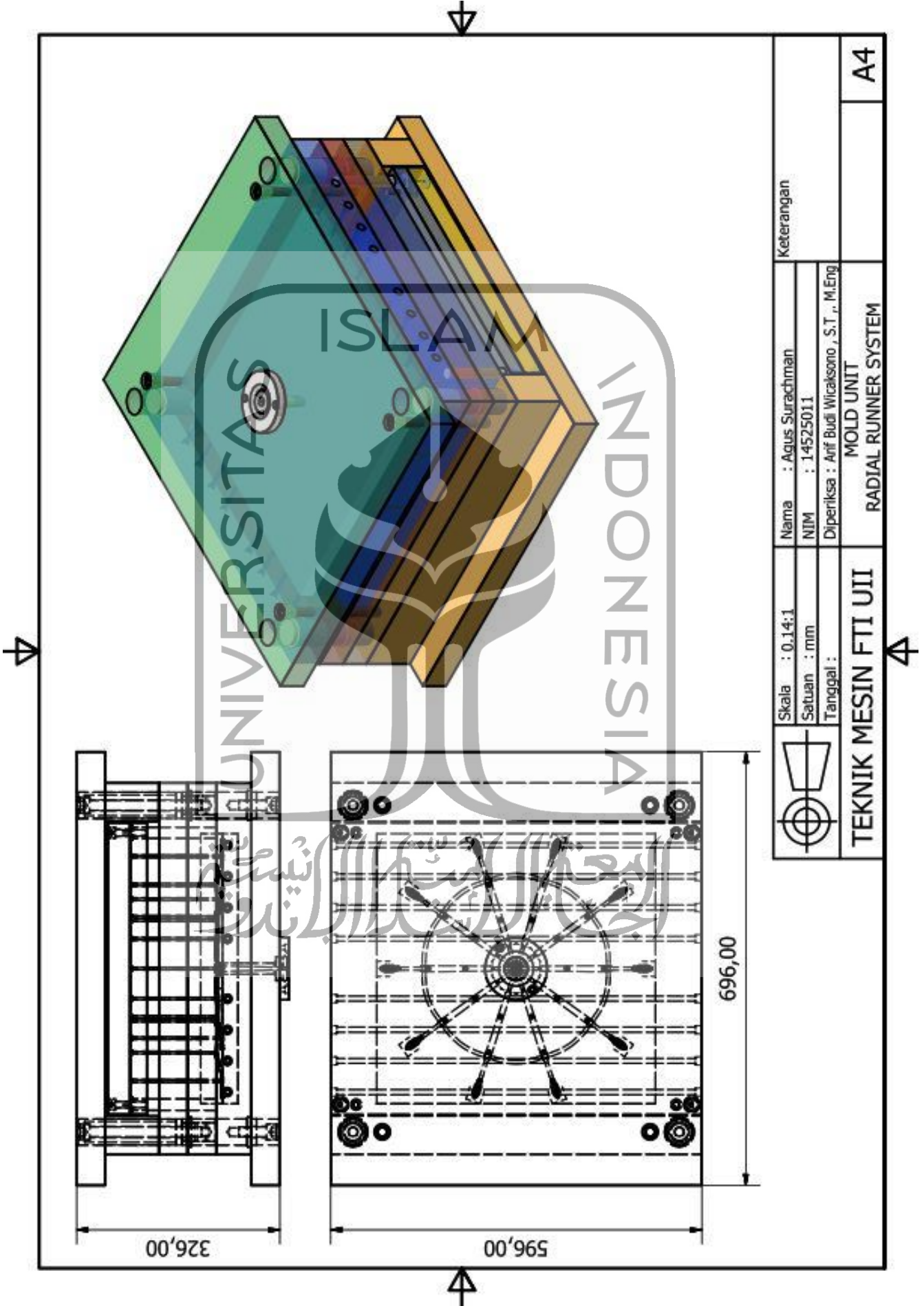

	Skala : 1:8	Nama : Agus Surachman	Keterangan
	Satuan : mm	NIM : 14525011	
	Tanggal :	Diperiksa : Arif Budi Wicaksono, S.T., M.Eng	
TEKNIK MESIN FTI UIN		EXPLODE VIEW MOLD UNIT GRID RUNNER SYSTEM	
			A4

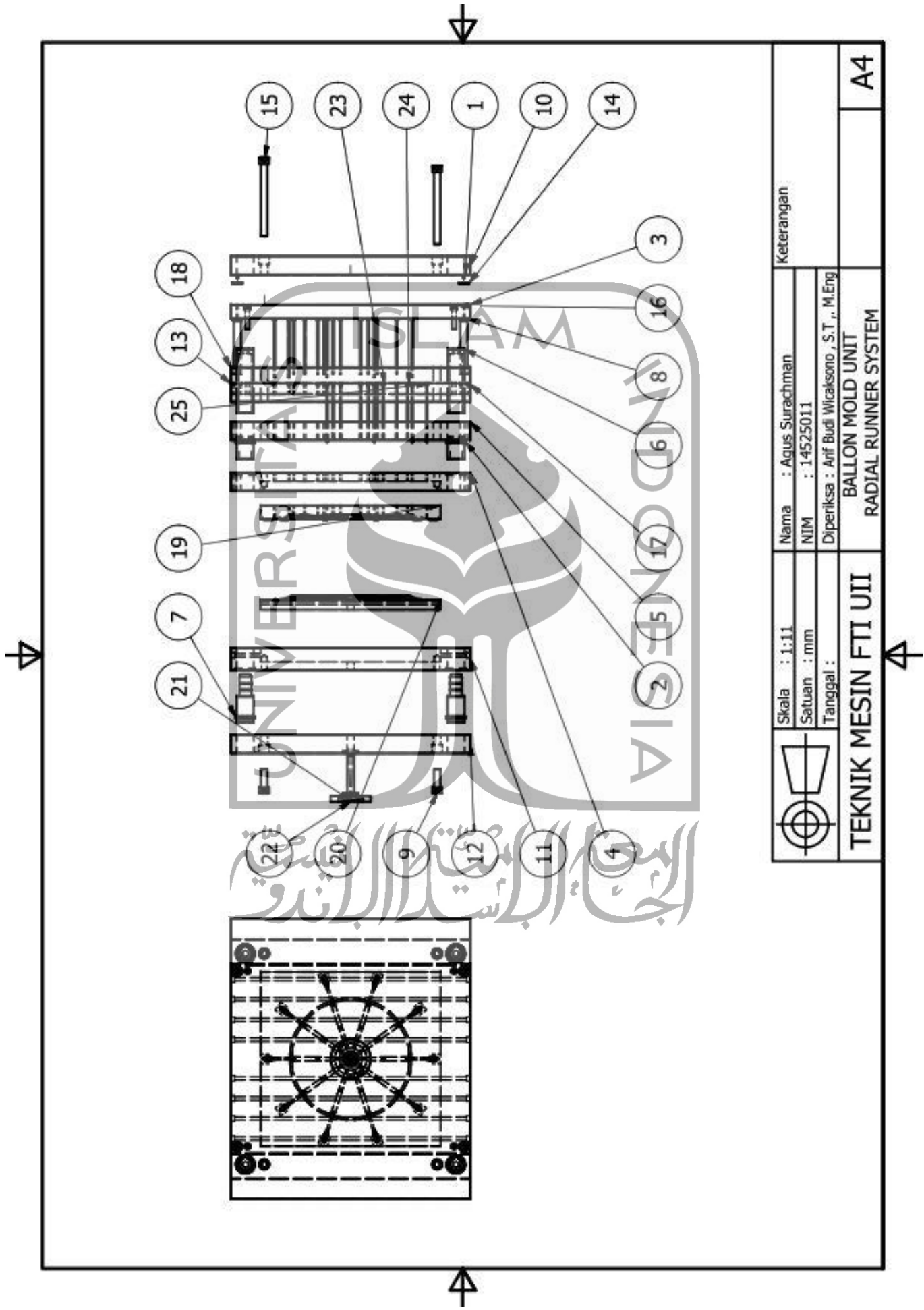

	Skala : 0.14:1	Nama : Agus Surachman	Keterangan
	Satuan : mm	NIM : 14525011	
	Tanggal :	Diperiksa : Arif Budi Wicaksono, S.T., M.Eng	
TEKNIK MESIN FTI UII		MOLD UNIT	
		RADIAL RUNNER SYSTEM	
			A4



	Skala : 1:11	Nama : Agus Surachman	Keterangan
	Satuan : mm	NIM : 14525011	
	Tanggal :	Diperiksa : Arif Budi Wicaksono , S.T., M.Eng	
TEKNIK MESIN FTI UII		BALLON MOLD UNIT RADIAL RUNNER SYSTEM	
		A4	





PARTS LIST			
ITEM	QTY	PART NUMBER	DESCRIPTION
1	4	SM 4x8	Socket Head Countersunk Screw
2	4	EG10046-30	Leader Pin Bushings
3	1	E 700-596x468x36	Ejector Plate
4	1	E 200_Core Plate-596x596x46	Core Plate
5	1	E 300-596x596x46	Support Plate
6	4	EG 200 42x160	Locating sleeves
7	4	EG 000 56-30x55	Leader Pins
8	4	Return Pin E 18x138	Return Pin
9	4	M 16x45	Socket Head Cap Screw DIN 912 - 12.9
10	1	E 110-596x696x46	Bottom Clamping Plate
11	1	E 200-596x596x56	Cavity Plate
12	1	E 100-596x696x46	Top Clamping Plate
13	1	E 600-596x468x27	Ejector Retainer Plate
14	4	"SB 3"	Spacer washer for ejector plates
15	4	M 16x180	Socket Head Cap Screw DIN 912 - 12.9
16	4	M 10x50	Socket Head Cap Screw DIN 912 - 12.9
17	1	E 400-596x596x86	Spacer Block
18	1	E 400-596x596x86	Spacer Block
19	1	Mold Desain radial_Combined CR1	
20	1	Mold Desain radial_Combined CV1	
21	1	Z51/18x96/3.5/15.5	Sprue Bushing
22	1	LR-100-36	Locating Ring
23	10	AH 3.7 -160	Ejector pins-hardened
24	10	AH 3.7 -160	Ejector pins-hardened
25	10	AH 3.7 -160	Ejector pins-hardened



	Skala :	Nama : Agus Surachman	Keterangan
	Satuan : mm	NIM : 14525011	
	Tanggal :	Diperiksa : Arif Budi Wicaksono , S.T., M.Eng	
TEKNIK MESIN FTI UII		PART LIST MOLD UNIT RADIAL RUNNER SYSTEM	A4

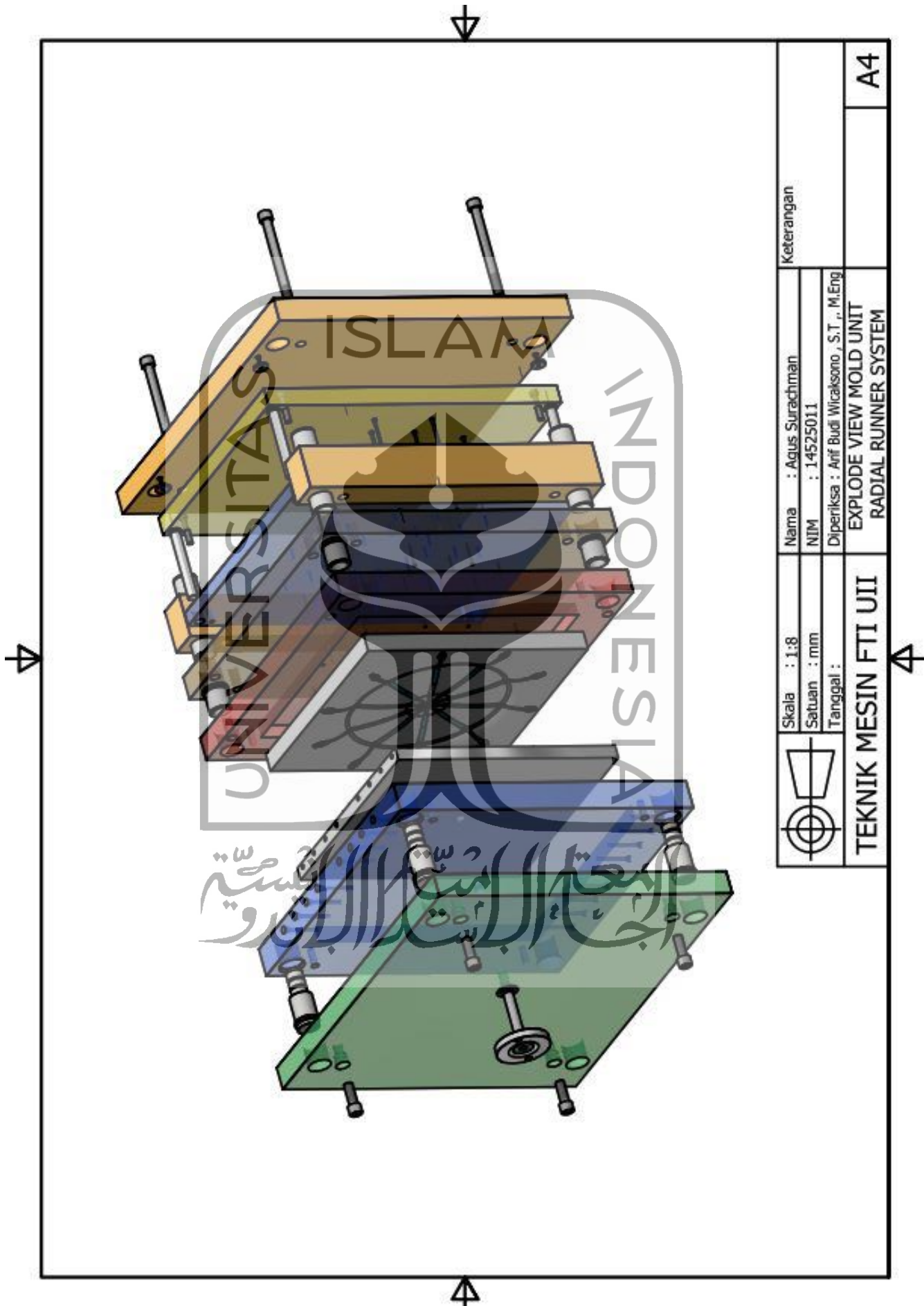



	Skala : 1:8	Nama : Agus Surachman	Keterangan
	Satuan : mm	NIM : 14525011	
	Tanggal :	Diperiksa : Arif Budi Wicaksono, S.T., M.Eng	
TEKNIK MESIN FTI UII		EXPLODE VIEW MOLD UNIT RADIAL RUNNER SYSTEM	A4

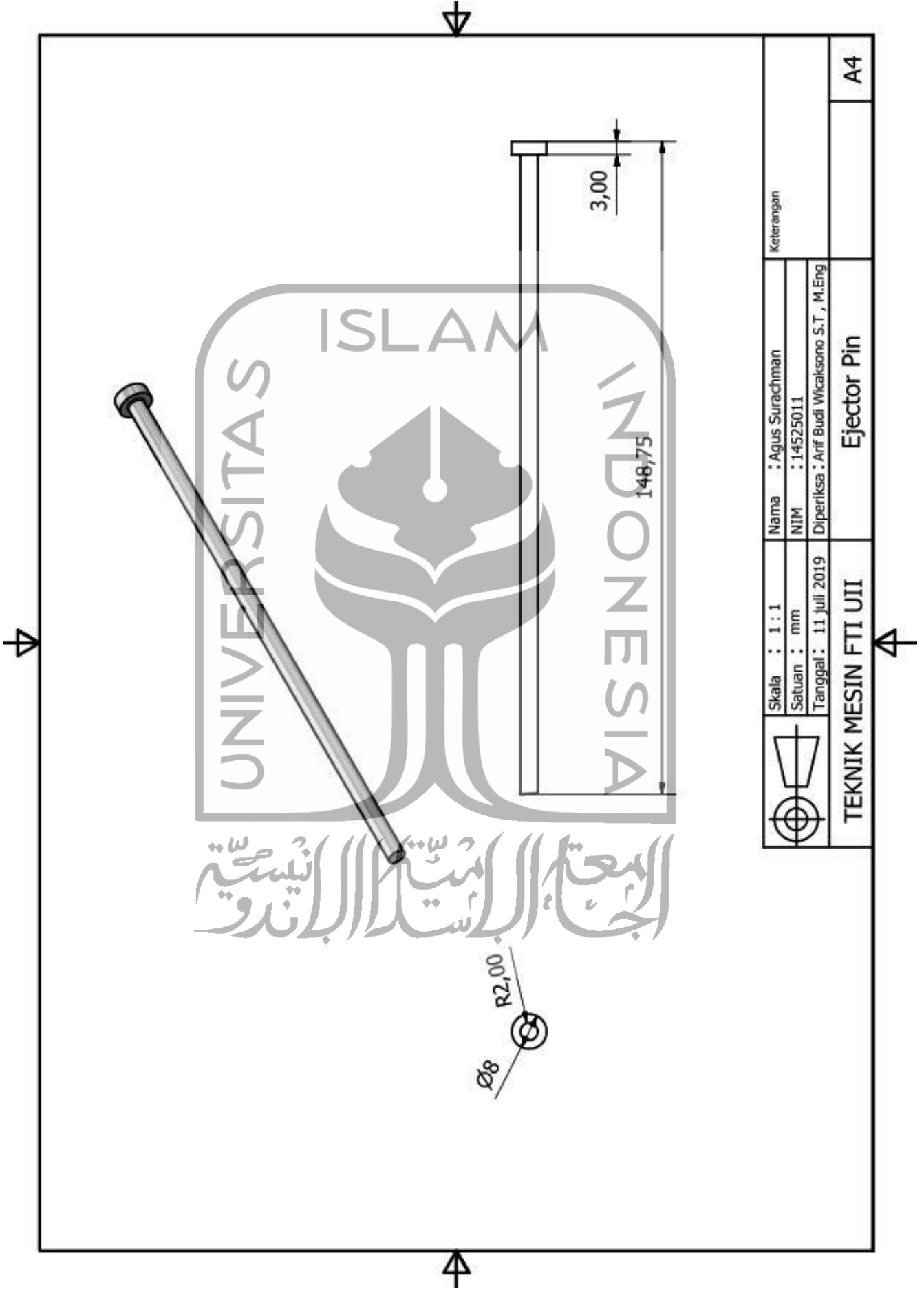

	Skala : 1 : 1	Nama : Agus Surachman	Keterangan
	Satuan : mm	NIM : 14525011	
	Tanggal : 11 Juli 2019	Diperiksa : Arif Budi Wicaksono S.T., M.Eng	
TEKNIK MESIN FTI UII		Ejector Pin	A4

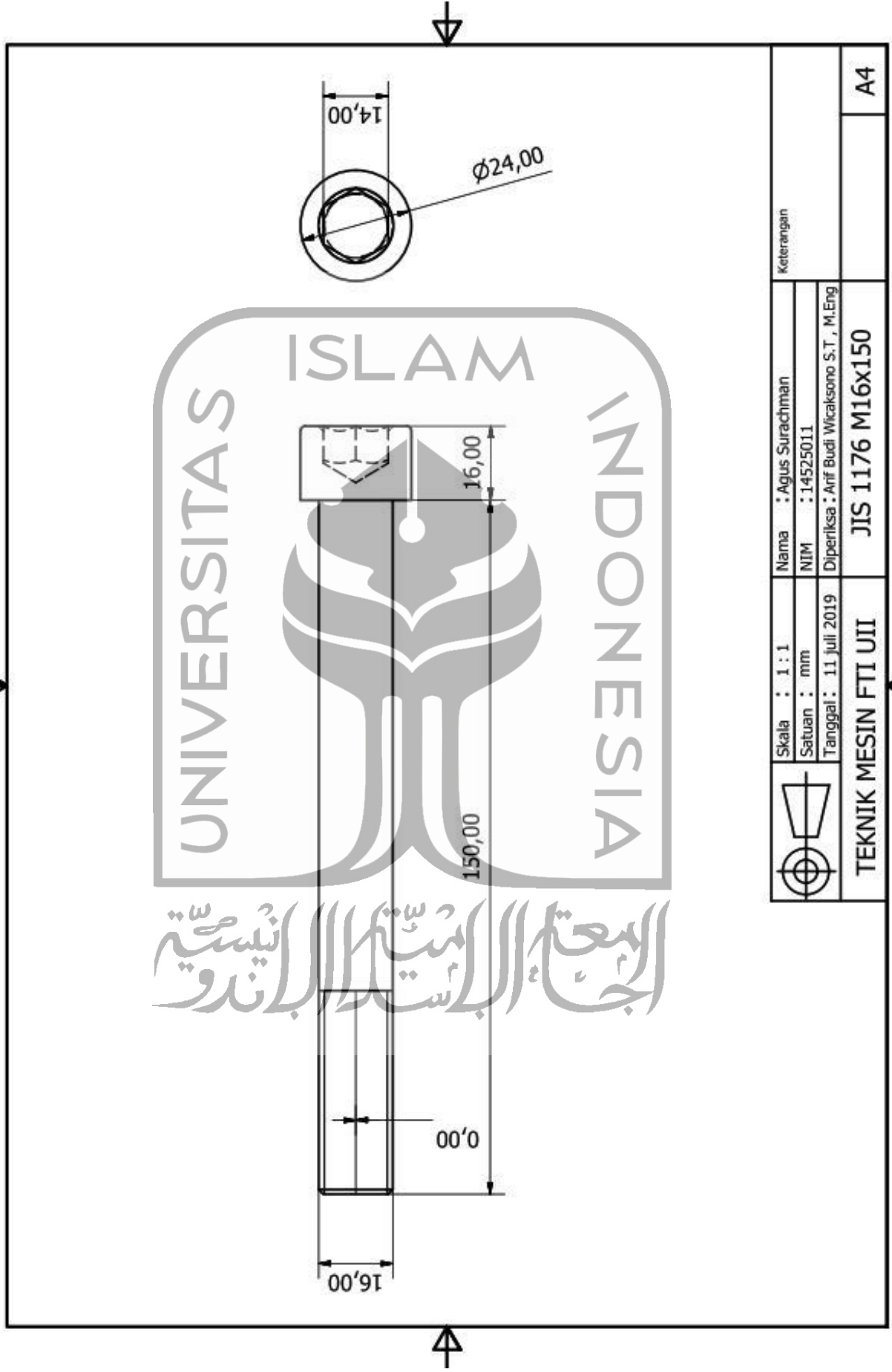

	Skala : 1 : 1	Nama : Agus Surachman	Keterangan
	Satuan : mm	NIM : 14525011	
	Tanggal : 11 Juli 2019	Diperiksa : Anif Budi Wicaksono S.T., M.Eng	
TEKNIK MESIN FTI UII		JIS 1176 M16x150	A4

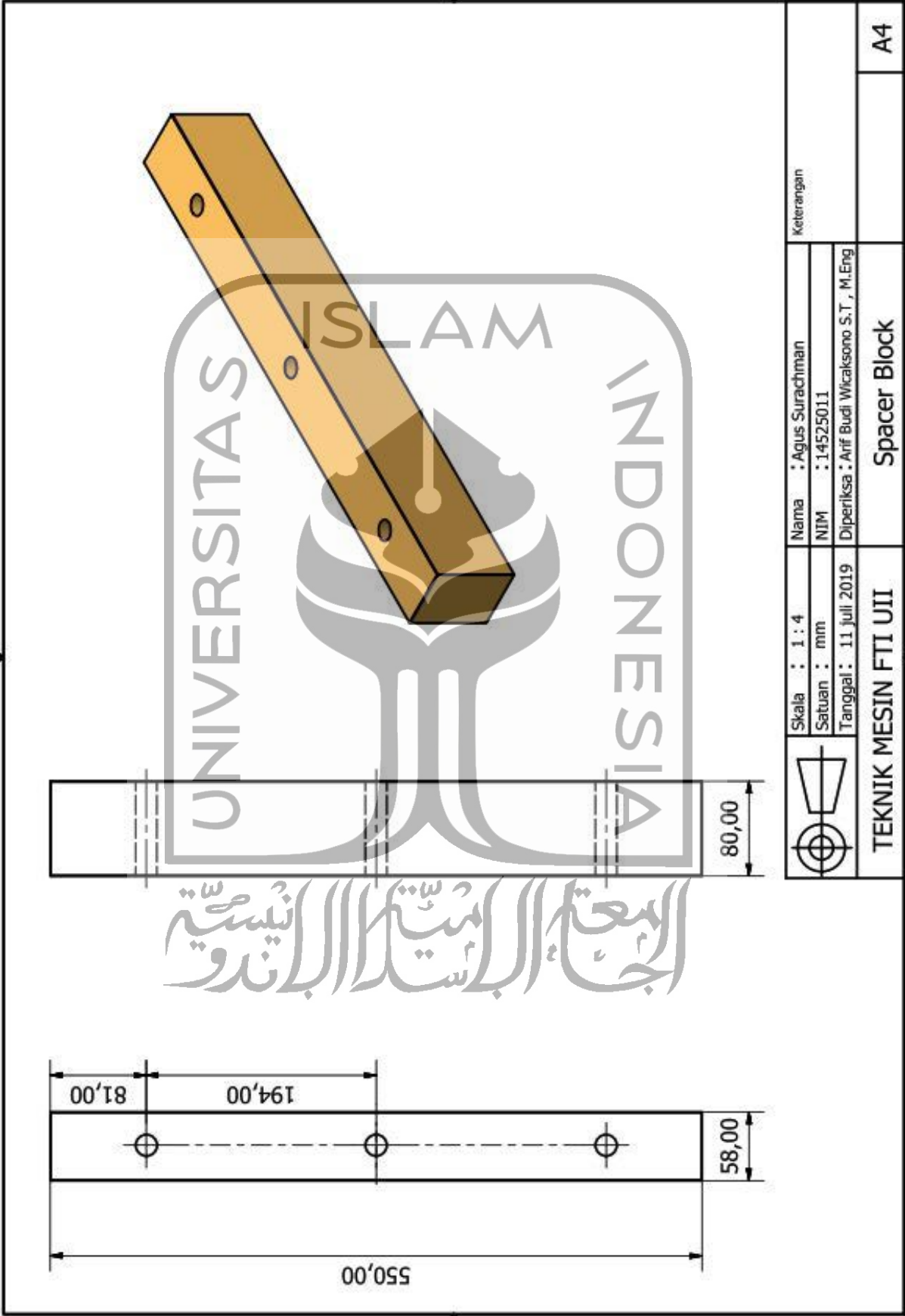

	Skala : 1 : 4	Nama : Agus Surachman	Keterangan
	Satuan : mm	NIM : 14525011	
	Tanggal : 11 juli 2019	Diperiksa : Arif Budi Wicaksono S.T., M.Eng	
TEKNIK MESIN FTI UII		Spacer Block	A4

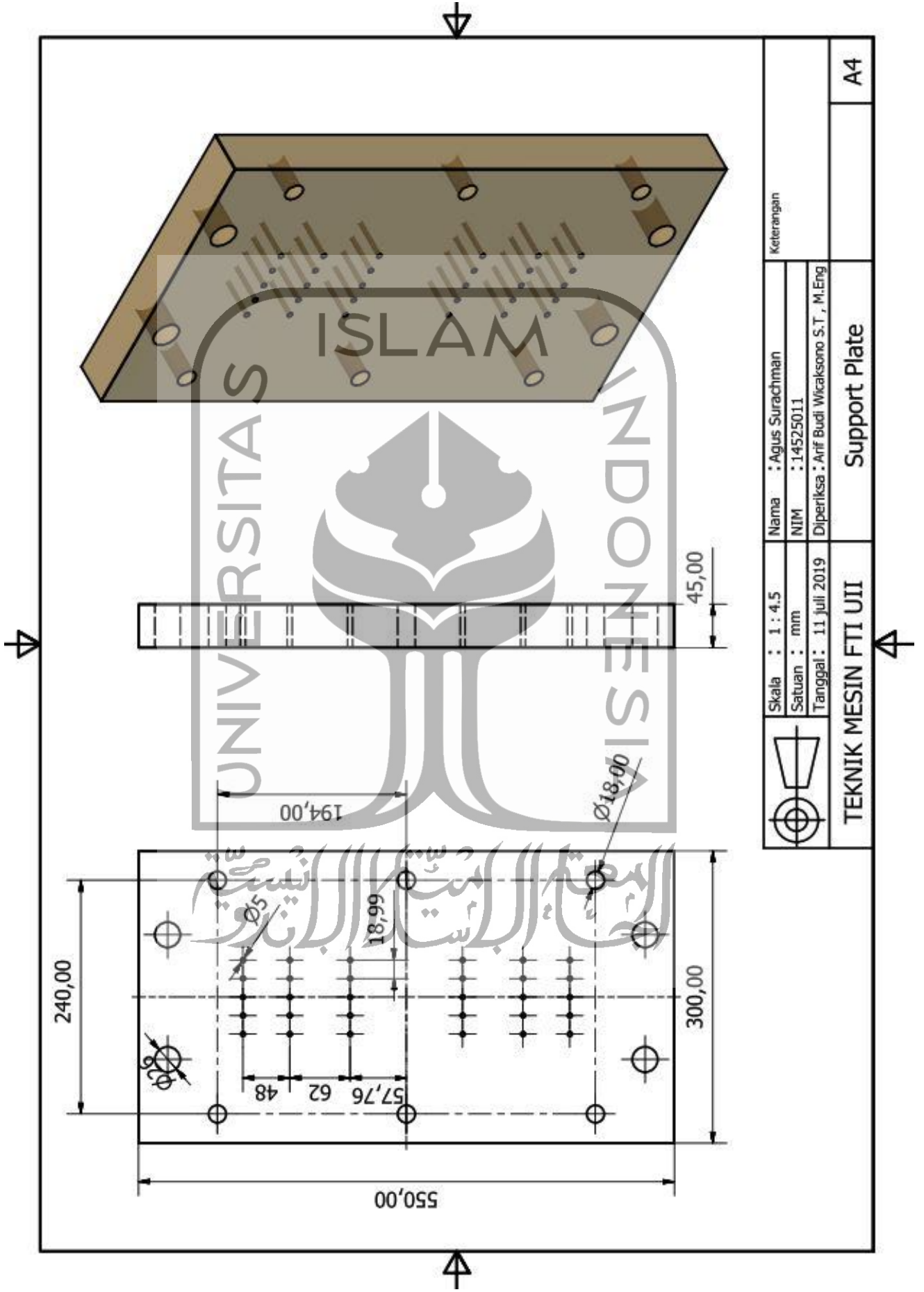

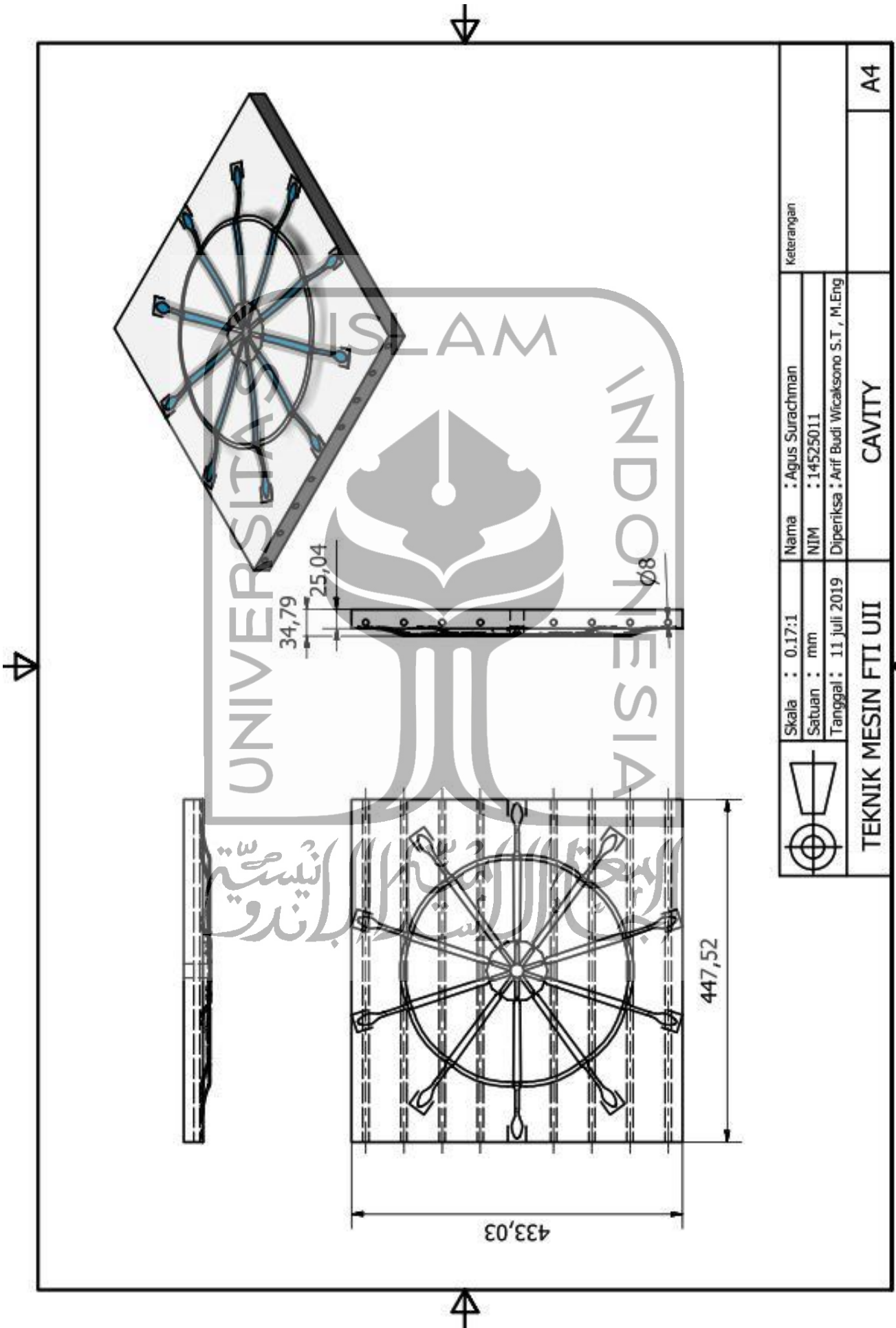

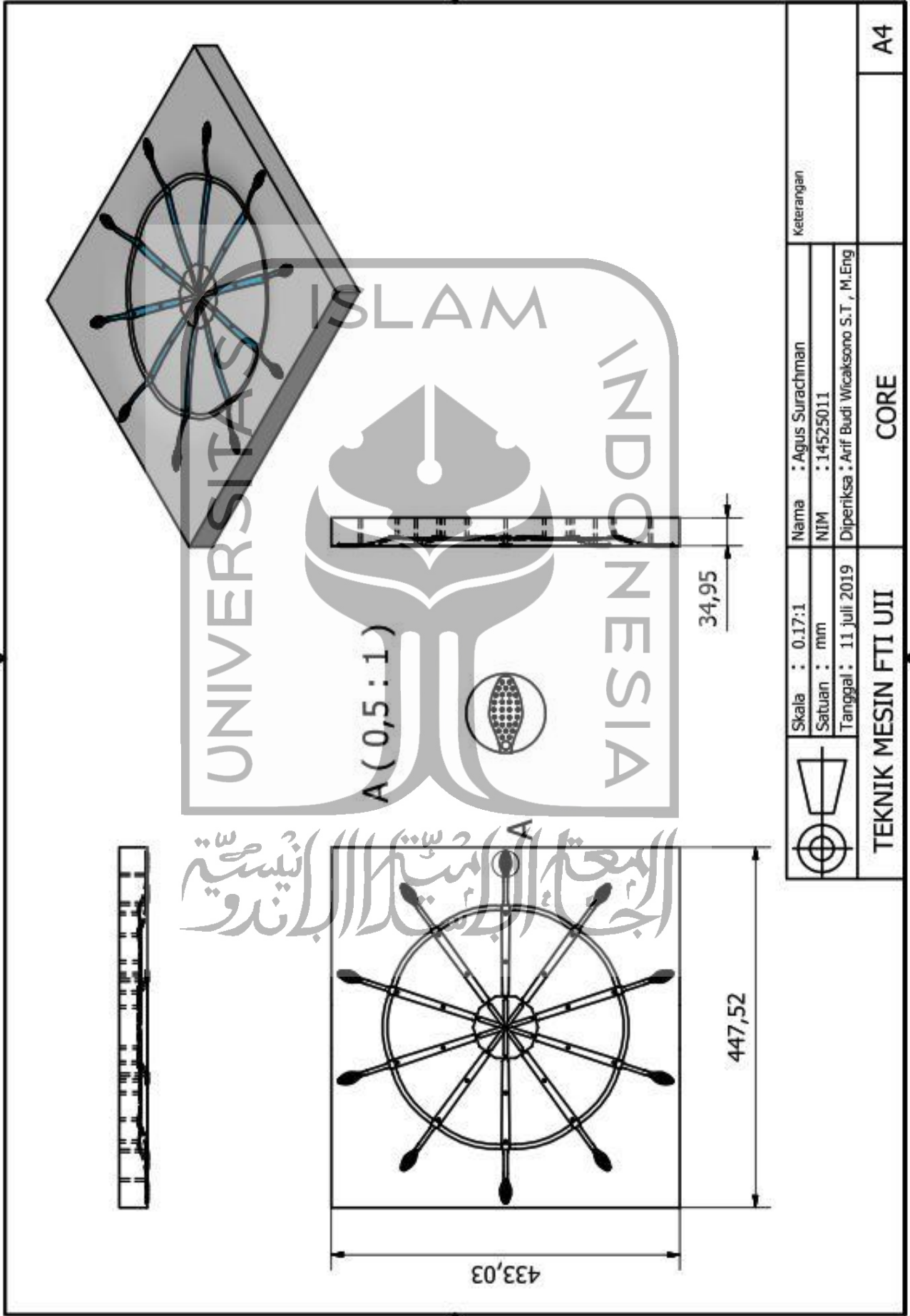

	Skala : 0.17:1	Nama : Agus Surachman	Keterangan
	Satuan : mm	NIM : 14525011	
	Tanggal : 11 juli 2019	Diperiksa : Arif Budi Wicaksono S.T , M.Eng	
TEKNIK MESIN FTI UII		CAVITY	A4

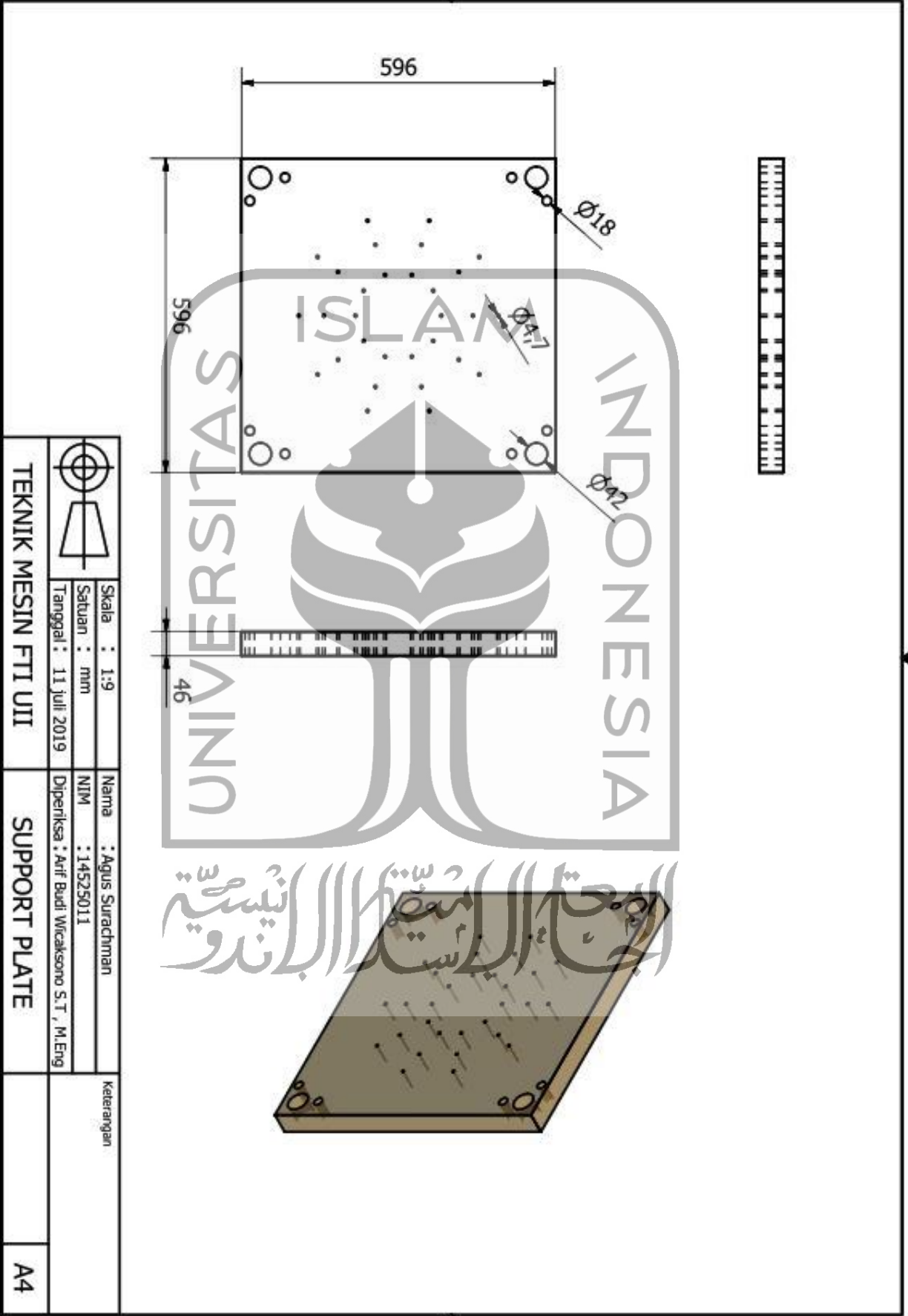



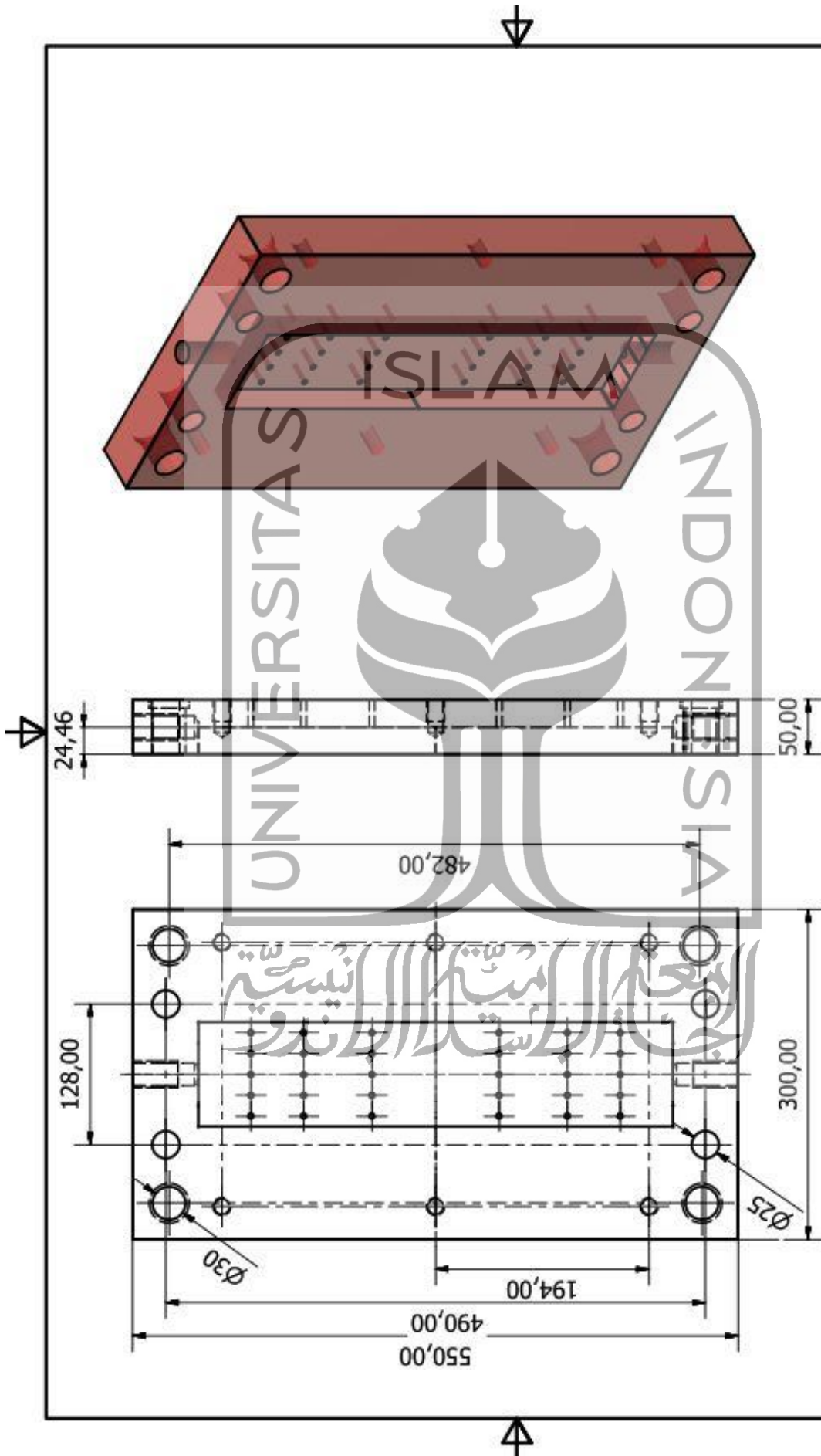

	Skala : 1:9	Nama : Agus Surachman	Keterangan
	Satuan : mm	NIM : 14525011	
Tanggal : 11 Juli 2019		Diperiksa : Arif Budi Wicaksono S.T., M.Eng	
TEKNIK MESIN FTI UII		SUPPORT PLATE	
			A4

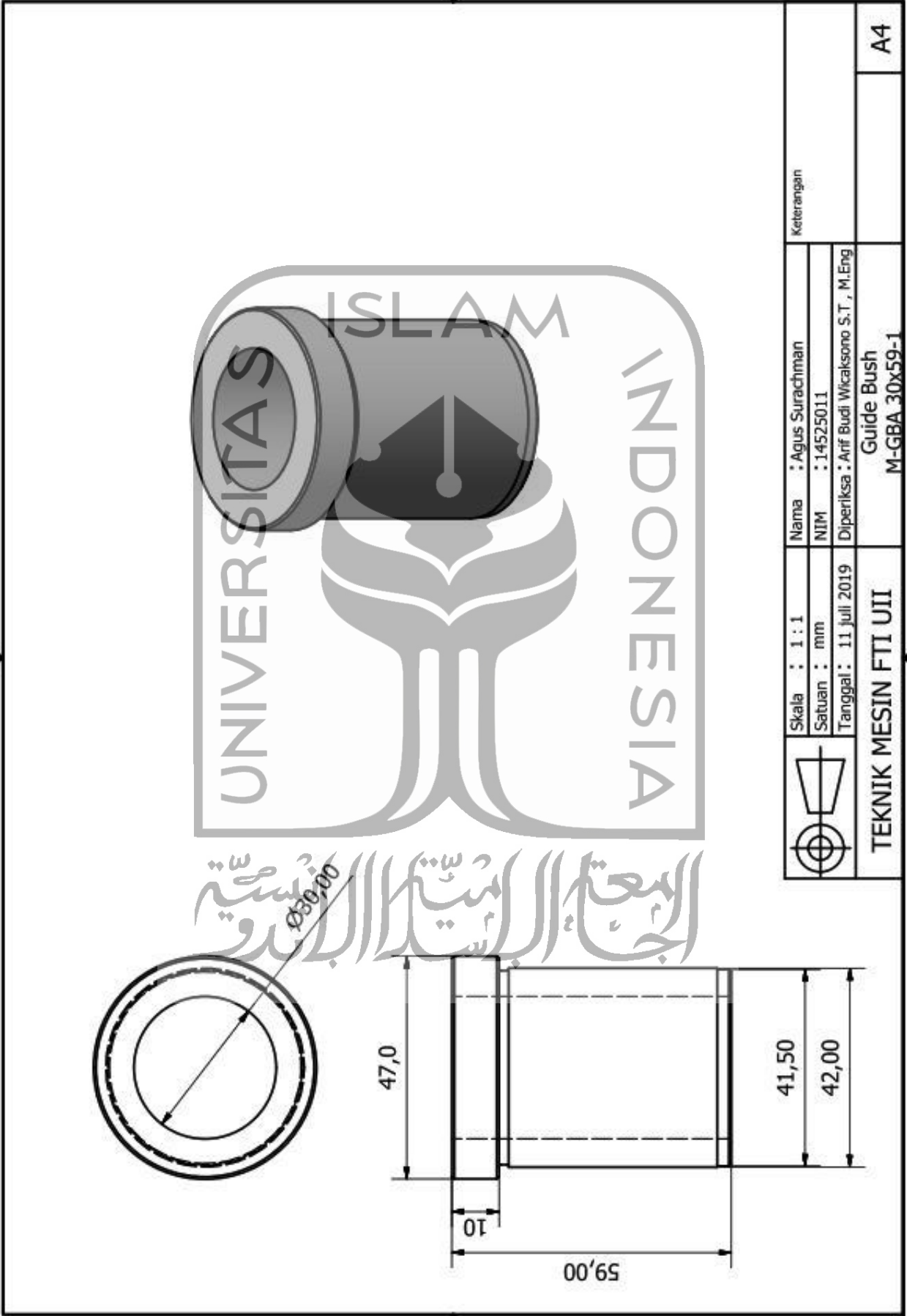

	Skala : 1 : 4	Nama : Agus Surachman	Keterangan
	Satuan : mm	NIM : 14525011	
	Tanggal : 11 Juli 2019	Diperiksa : Arif Budi Wicaksono S.T., M.Eng	
TEKNIK MESIN FTI UII		Core Plate	A4



	Skala : 1 : 1	Nama : Agus Surachman	Keterangan
	Satuan : mm	NIM : 14525011	
	Tanggal : 11 Juli 2019	Diperiksa : Anif Budi Wicaksono S.T., M.Eng	
TEKNIK MESIN FTI UII		Guide Bush M-GBA 30x59-1	A4

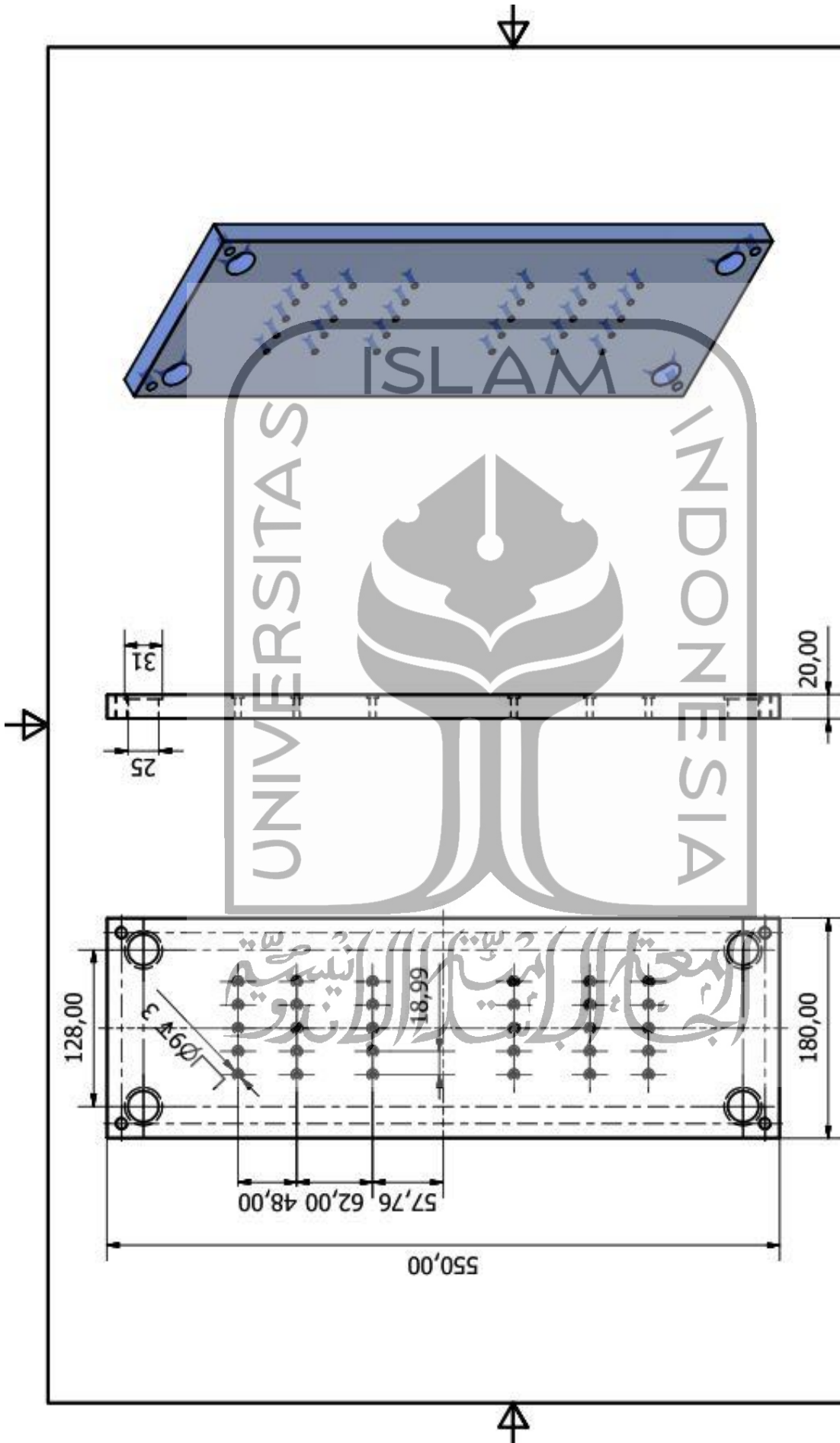

	Skala : 1 : 4	Nama : Agus Surachman	Keterangan
	Satuan : mm	NIM : 14525011	
	Tanggal : 11 juli 2019	Diperiksa : Anif Budi Wikaksono S.T., M.Eng	
TEKNIK MESIN FTI UII		Ejector Retainer Plate	
			A4

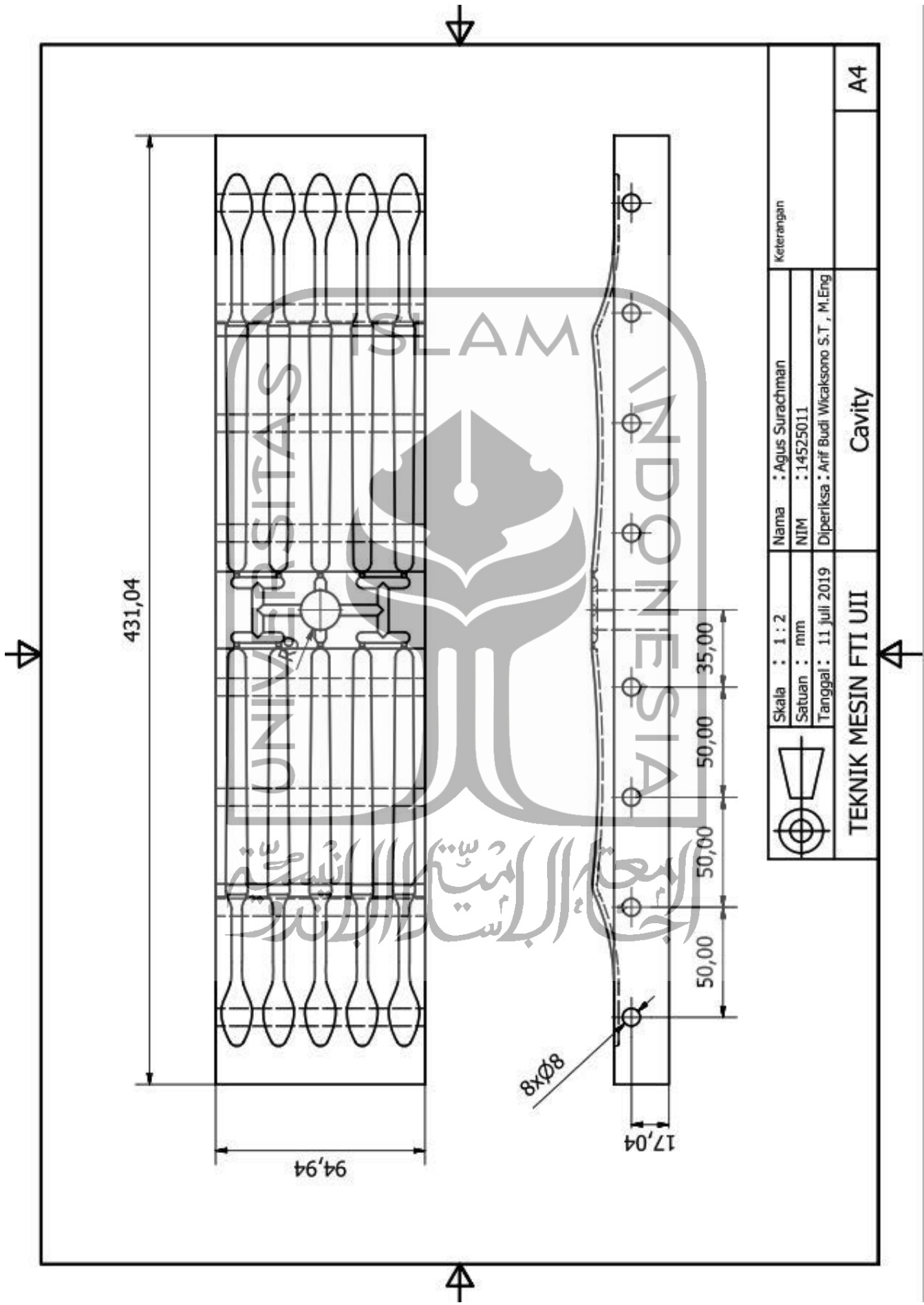

	Skala : 1 : 2	Nama : Agus Surachman	Keterangan
	Satuan : mm	NIM : 14525011	
	Tanggal : 11 juli 2019	Diperiksa : Arif Budi Wicaksono S.T., M.Eng	
TEKNIK MESIN FTI UII		Cavity	A4

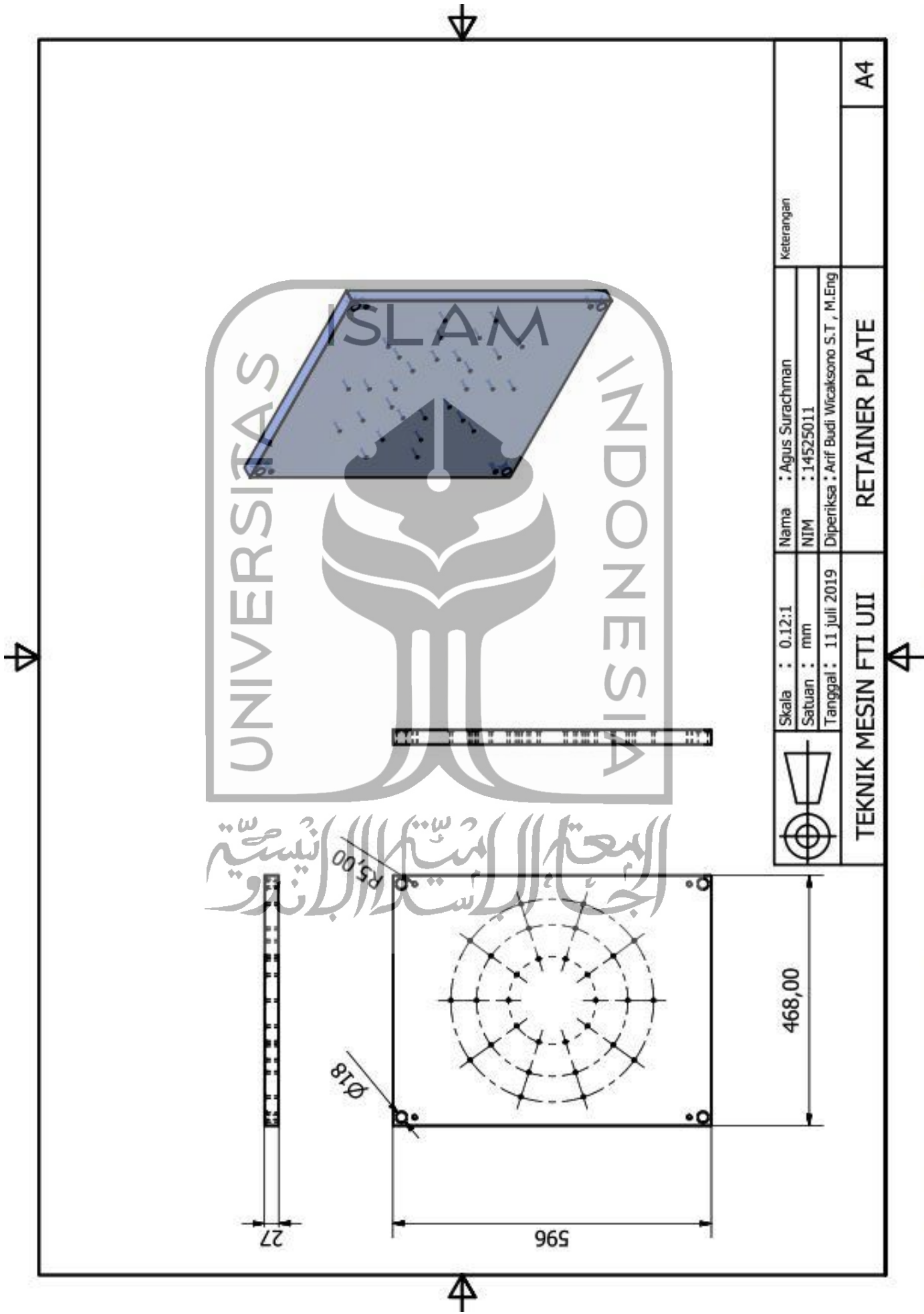

	Skala : 0.12:1	Nama : Agus Surachman	Keterangan
	Satuan : mm	NIM : 14525011	
Tanggal : 11 juli 2019		Diperiksa : Arif Budi Wicaksono S.T , M.Eng	
TEKNIK MESIN FTI UII		RETAINER PLATE	A4

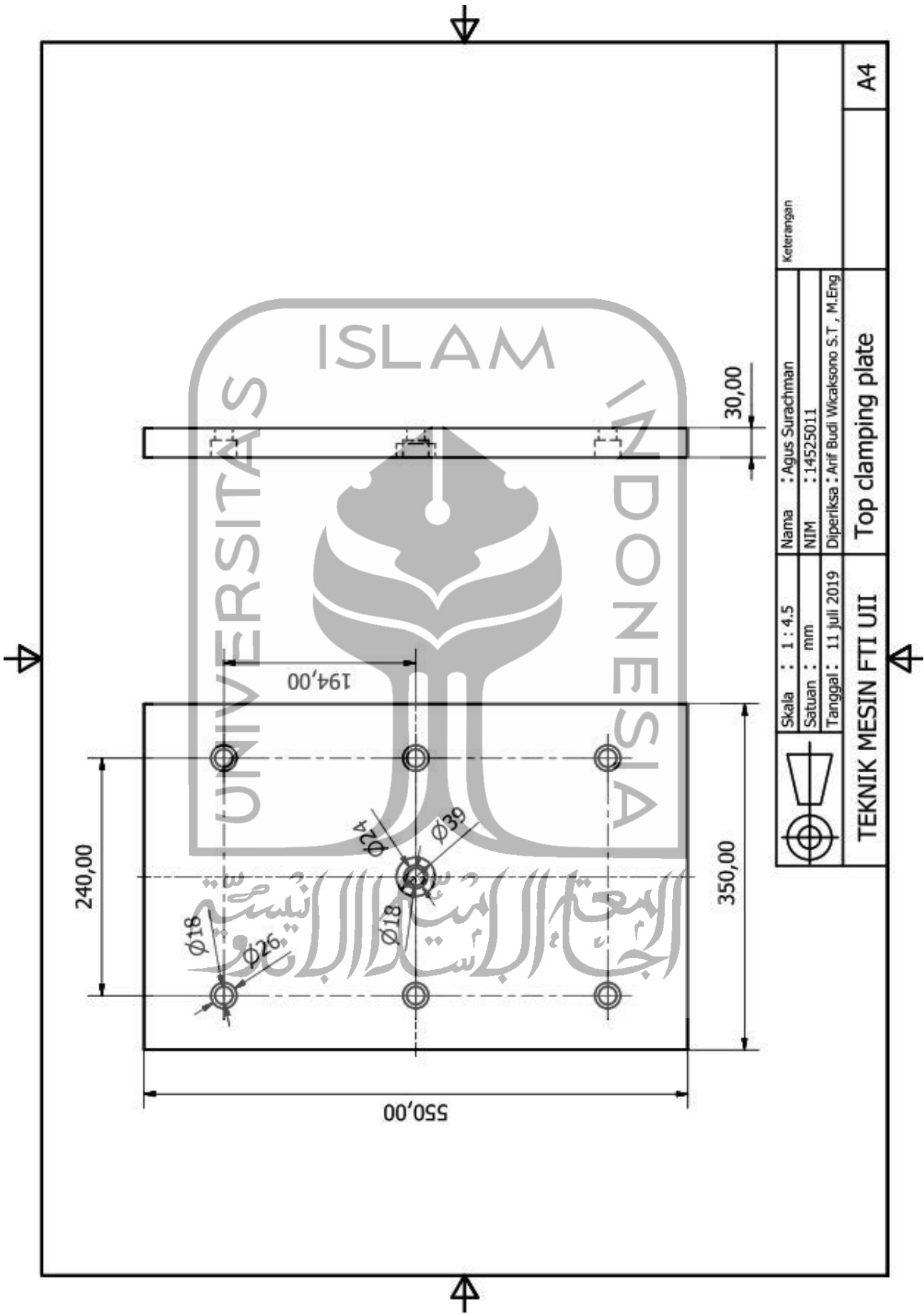

	Skala : 1 : 4.5	Nama : Agus Surachman	Keterangan
	Satuan : mm	NIM : 14525011	
	Tanggal : 11 Juli 2019	Diperiksa : Arif Budi Wicaksono S.T., M.Eng	
TEKNIK MESIN FTI UII		Top clamping plate	A4

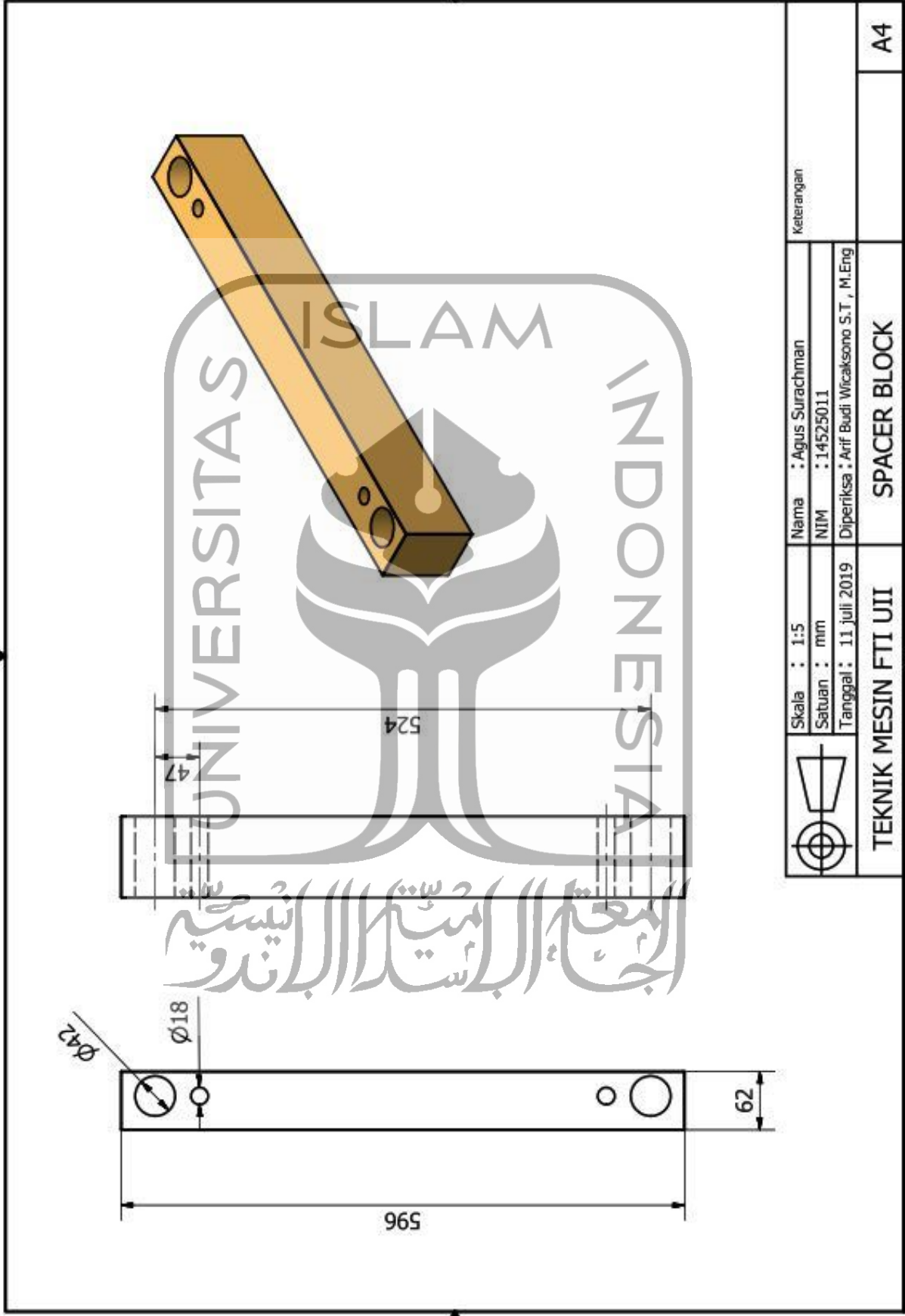

	Skala : 1:5	Nama : Agus Surachman	Keterangan
	Satuan : mm	NIM : 14525011	
	Tanggal : 11 juli 2019	Diperiksa : Arif Budi Wicaksono S.T., M.Eng	
TEKNIK MESIN FTI UJI		SPACER BLOCK	A4

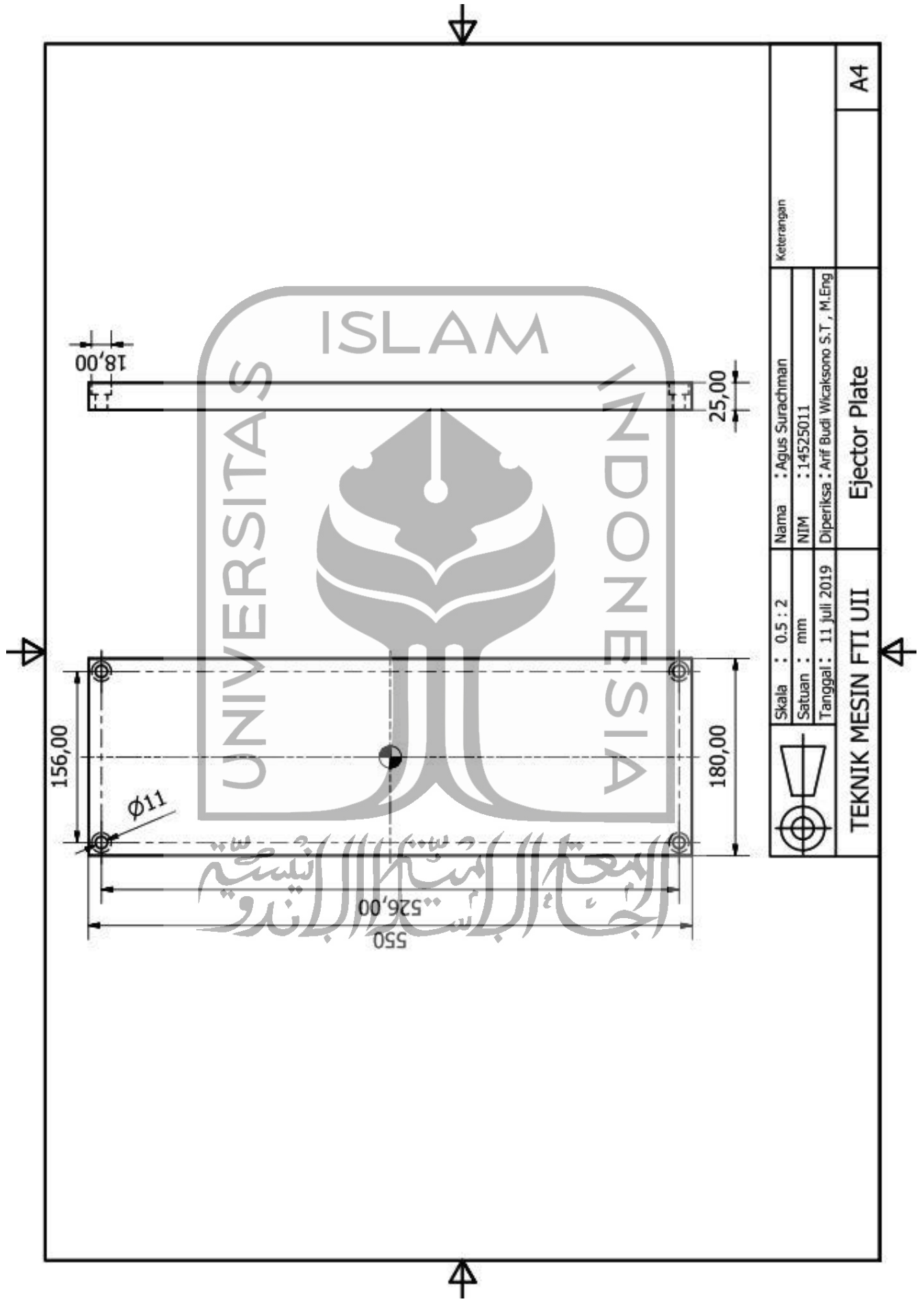

	Skala : 0.5 : 2	Nama : Agus Surachman	Keterangan
	Satuan : mm	NIM : 14525011	
	Tanggal : 11 Juli 2019	Diperiksa : Arif Budi Wicaksono S.T., M.Eng	
TEKNIK MESIN FTI UII		Ejector Plate	A4

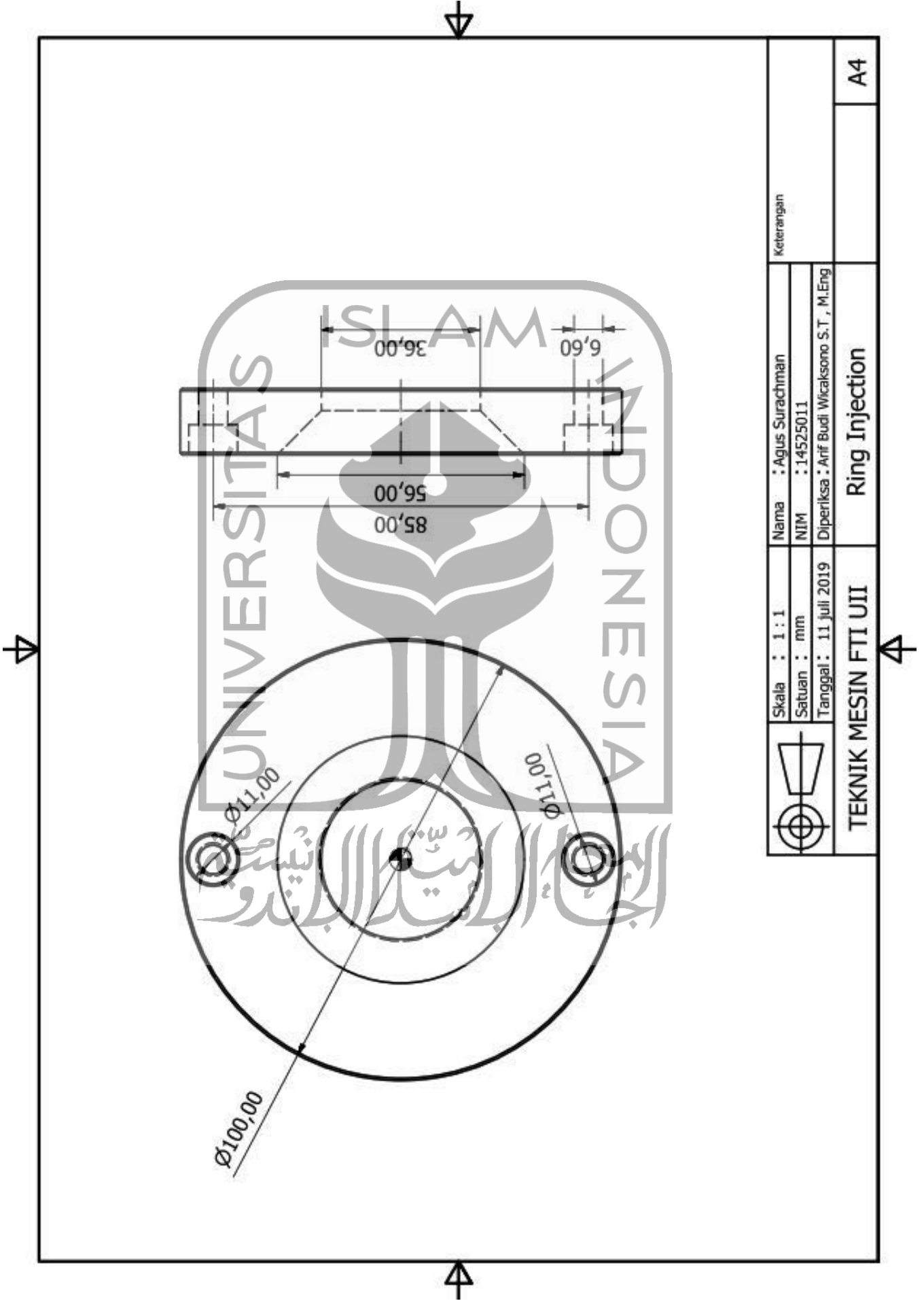

Skala : 1 : 1
 Satuan : mm
 Tanggal : 11 Juli 2019

Nama : Agus Surachman
 NIM : 14525011
 Diperiksa : Arif Budi Wicaksono S.T., M.Eng

Keterangan

TEKNIK MESIN FTI UII

Ring Injection

A4

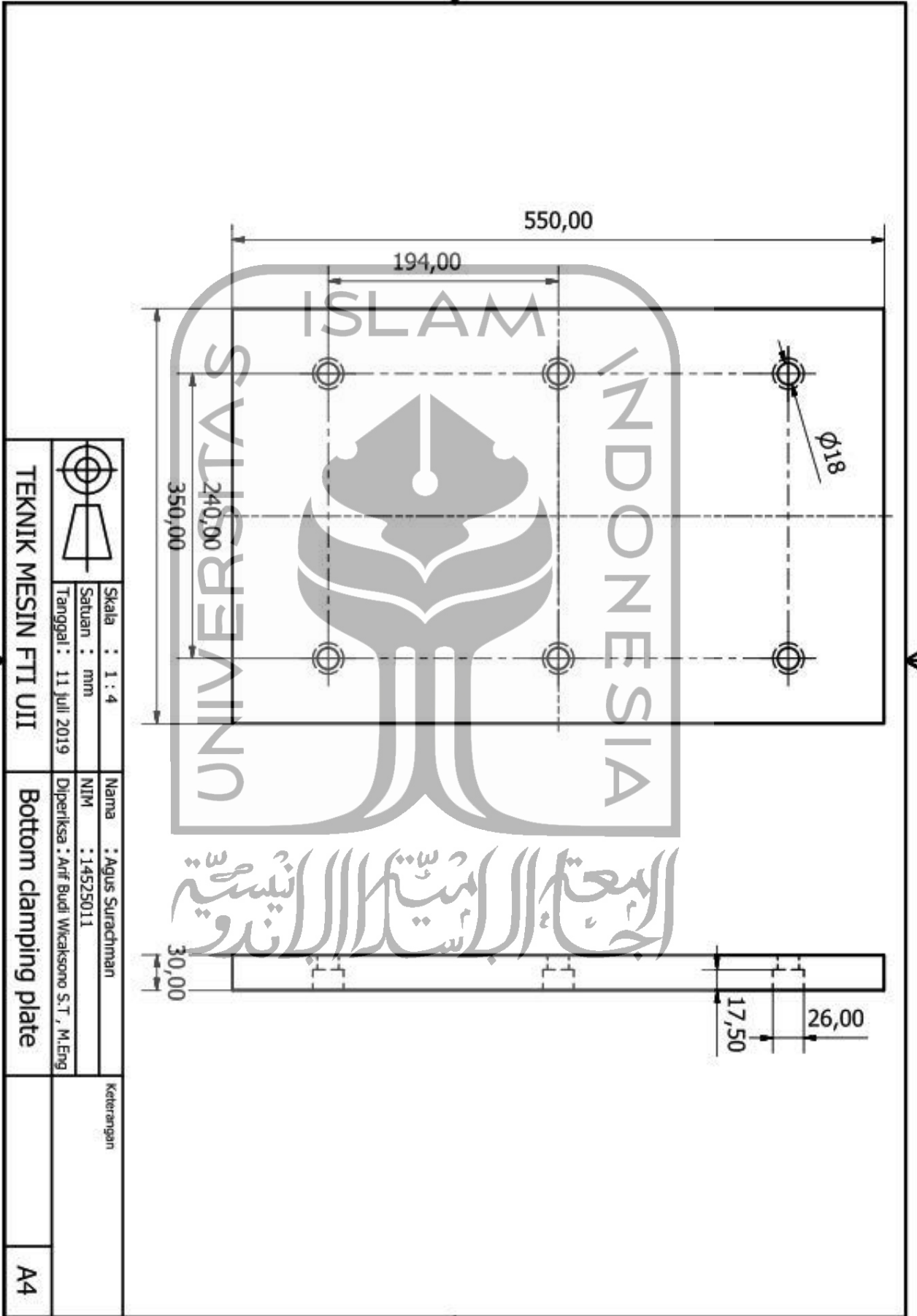

	Skala : 1 : 4	Nama : Agus Surachman	Keterangan
	Satuan : mm	NIM : 14525011	
	Tanggal : 11 Juli 2019	Diperiksa : Arif Budi Wicaksono S.T., M.Eng	
TEKNIK MESIN FTI UII	Bottom clamping plate		A4

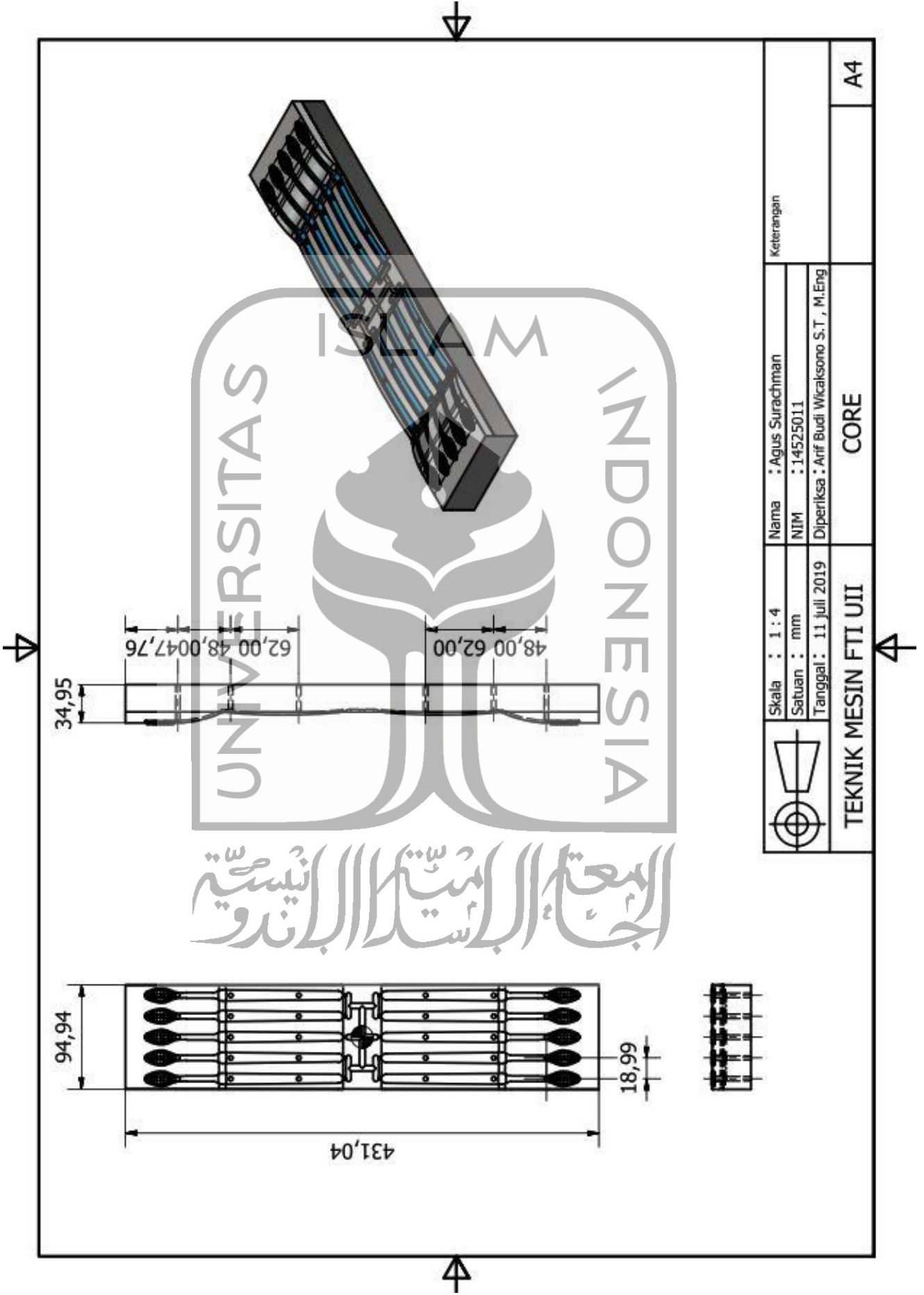

Skala : 1 : 4 Satuan : mm Tanggal : 11 Juli 2019	Nama : Agus Surachman	Keterangan
	NIM : 14525011	
	Diperiksa : Arif Budi Wikaksono S.T., M.Eng	
TEKNIK MESIN FTI UII		CORE
		A4

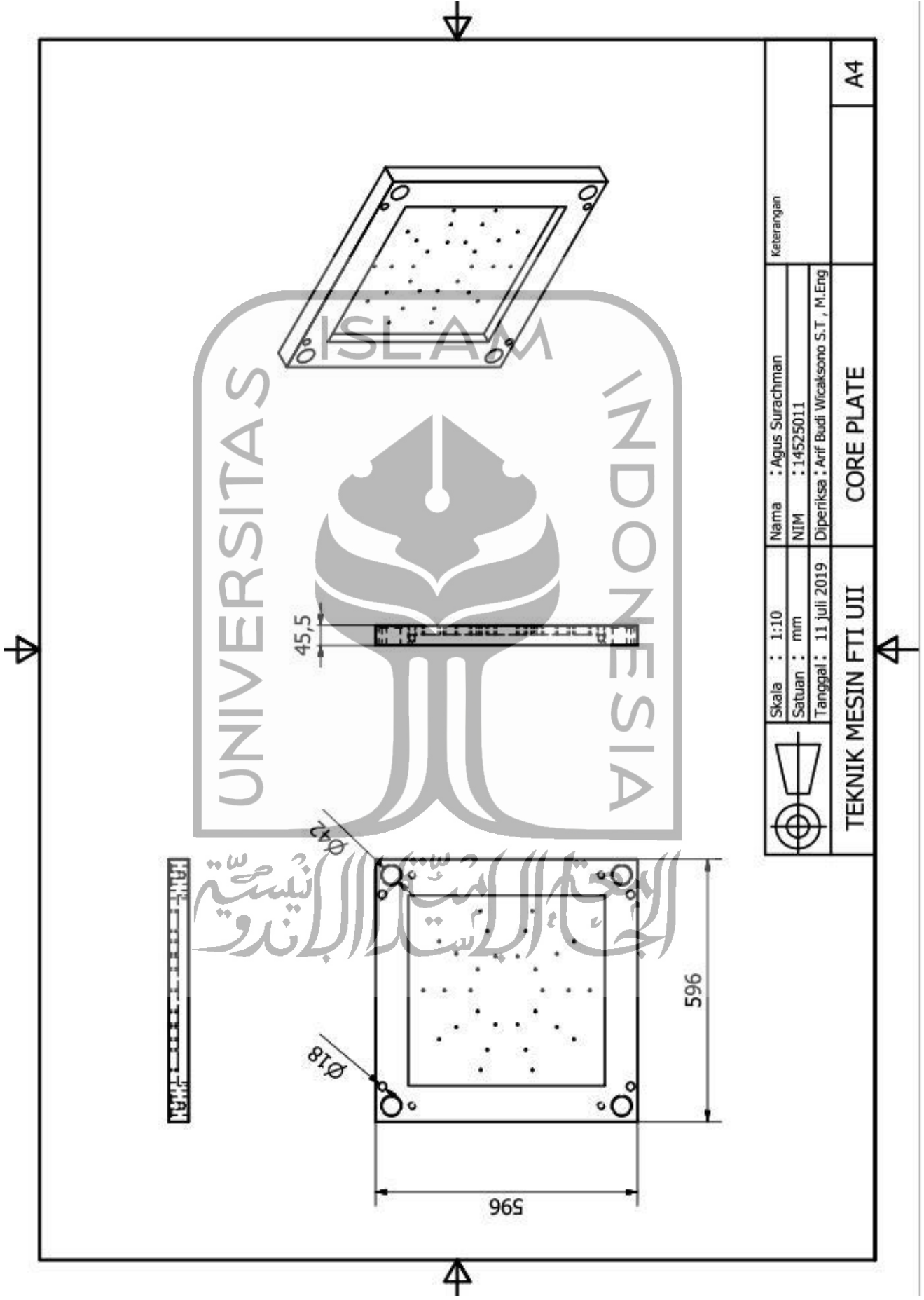

	Skala : 1:10	Nama : Agus Surachman	Keterangan
	Satuan : mm	NIM : 14525011	
	Tanggal : 11 Juli 2019	Diperiksa : Arif Budi Wicaksono S.T., M.Eng	
TEKNIK MESIN FTI UII		CORE PLATE	
			A4

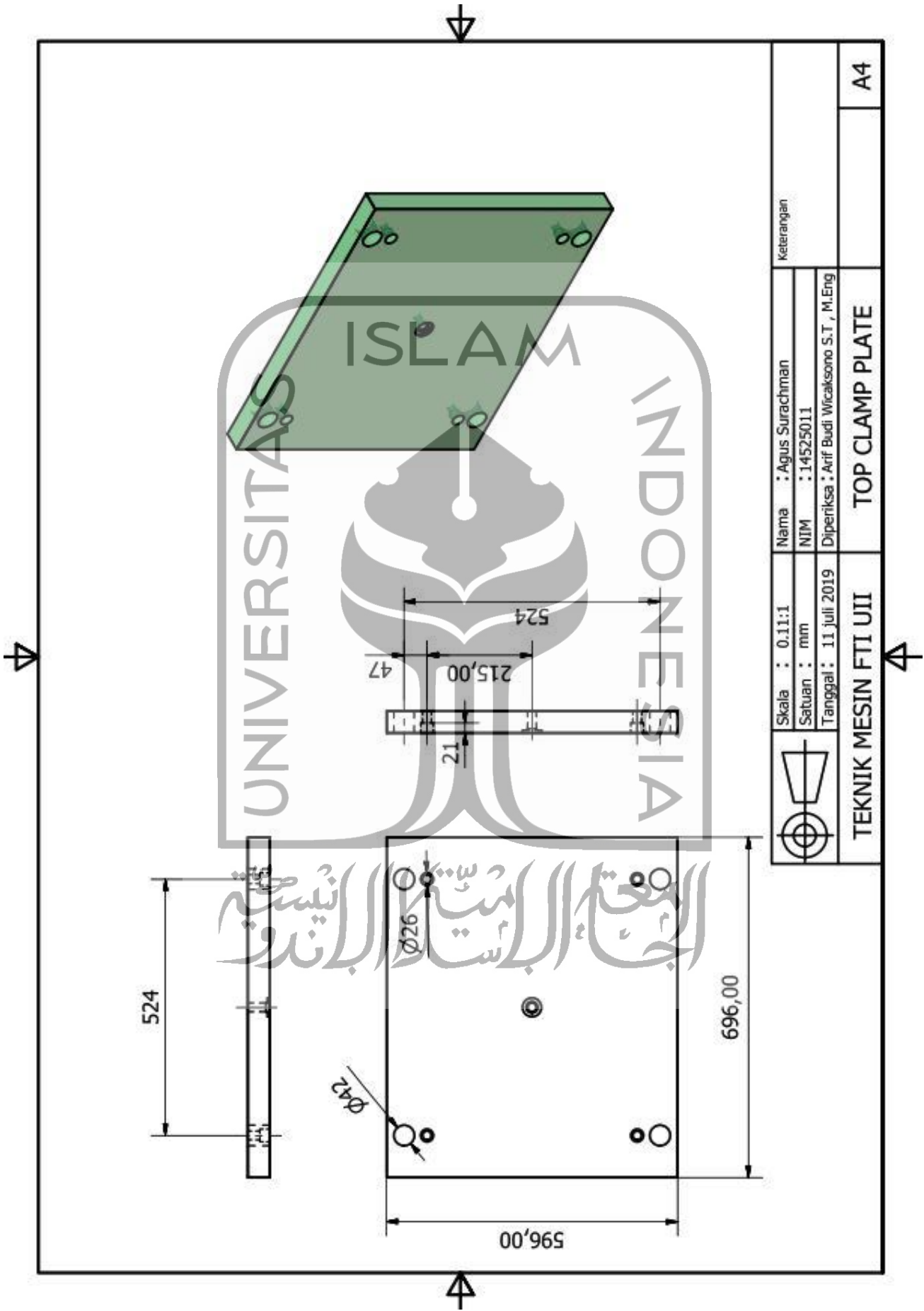

	Skala : 0.11:1	Nama : Agus Surachman	Keterangan
	Satuan : mm	NIM : 14525011	
	Tanggal : 11 Juli 2019	Diperiksa : Arif Budi Wicaksono S.T., M.Eng	
TEKNIK MESIN FTI UII		TOP CLAMP PLATE	
			A4

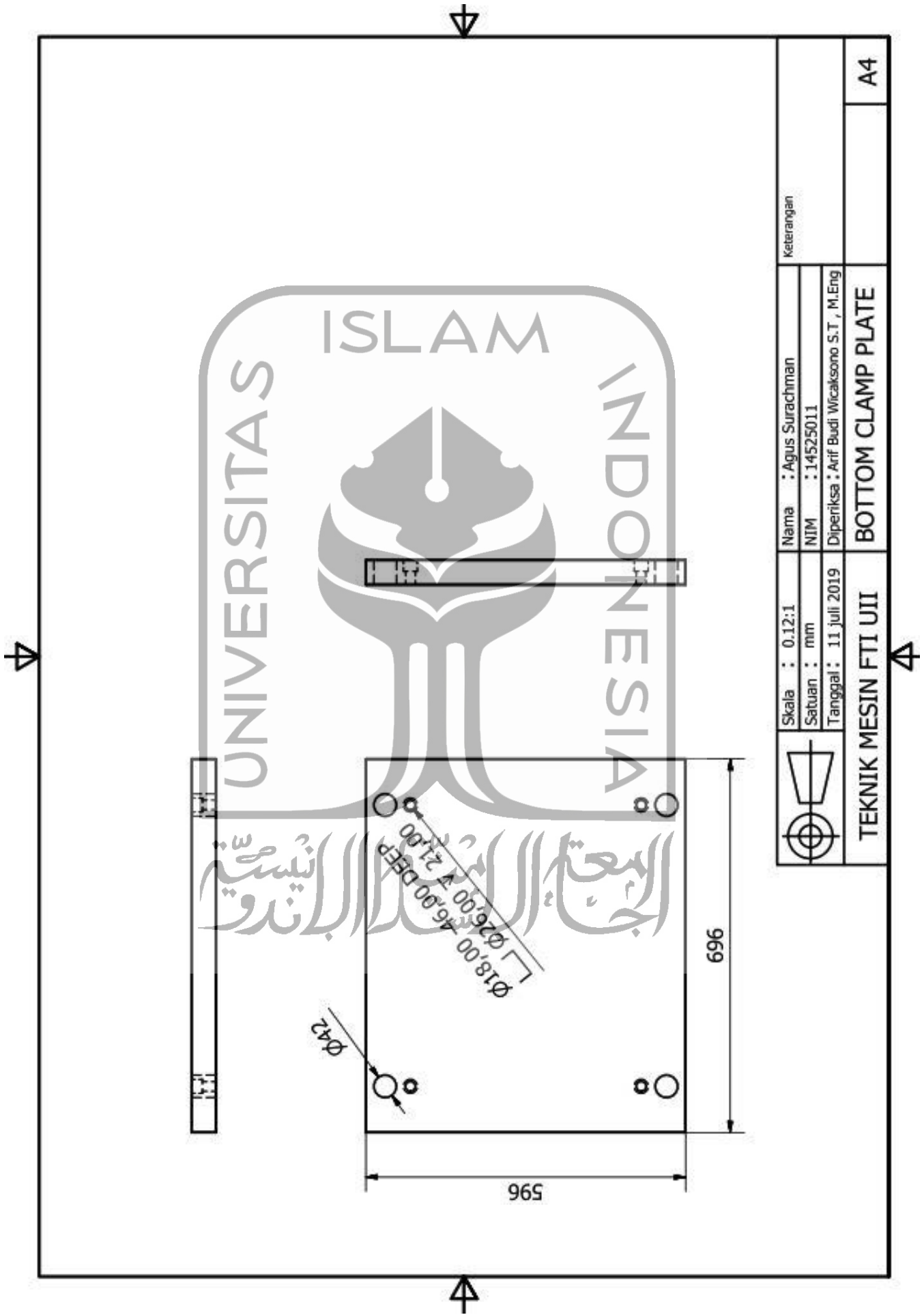

	Skala : 0.12:1	Nama : Agus Surachman	Keterangan
	Satuan : mm	NIM : 14525011	
	Tanggal : 11 juli 2019	Diperiksa : Arif Budi Wicaksono S.T , M.Eng	
TEKNIK MESIN FTI UII		BOTTOM CLAMP PLATE	
			A4

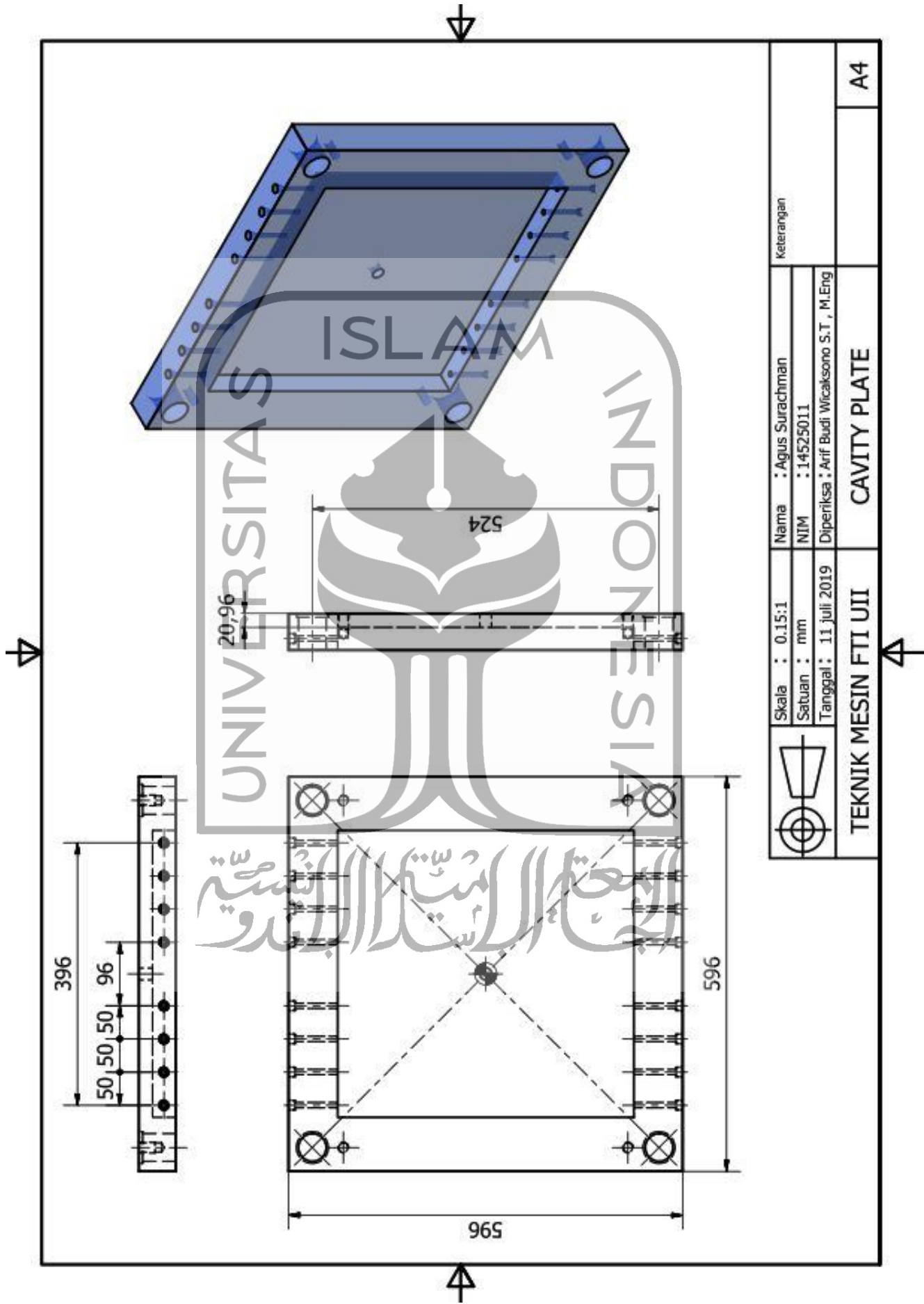

	Skala : 0.15:1	Nama : Agus Surachman	Keterangan
	Satuan : mm	NIM : 14525011	
	Tanggal : 11 juli 2019	Diperiksa : Anif Budi Wicaksono S.T , M.Eng	
TEKNIK MESIN FTI UII		CAVITY PLATE	A4

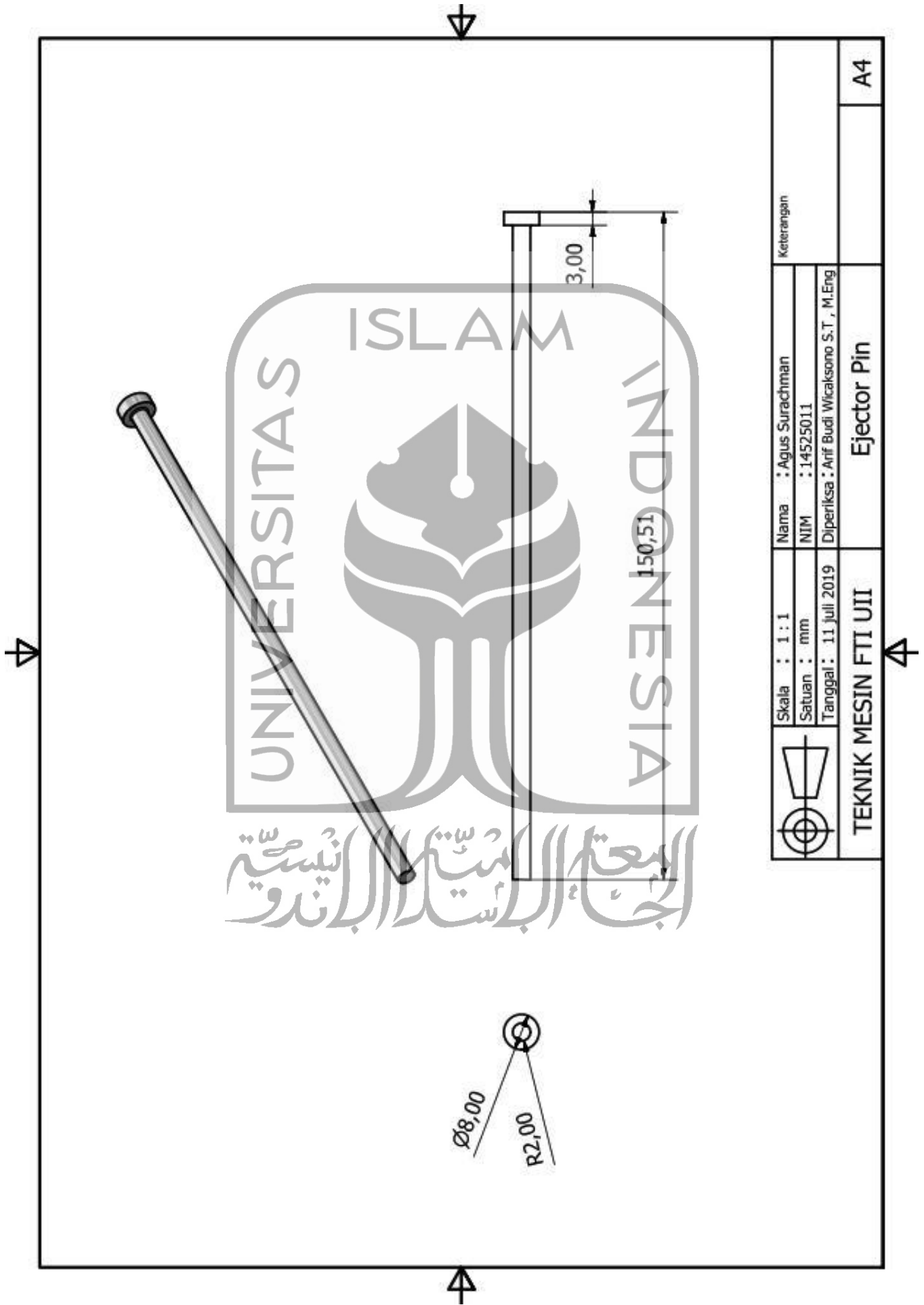

	Skala : 1 : 1	Nama : Agus Surachman	Keterangan
	Satuan : mm	NIM : 14525011	
	Tanggal : 11 juli 2019	Diperiksa : Arif Budi Wicaksono S.T., M.Eng	
TEKNIK MESIN FTI UII		Ejector Pin	A4

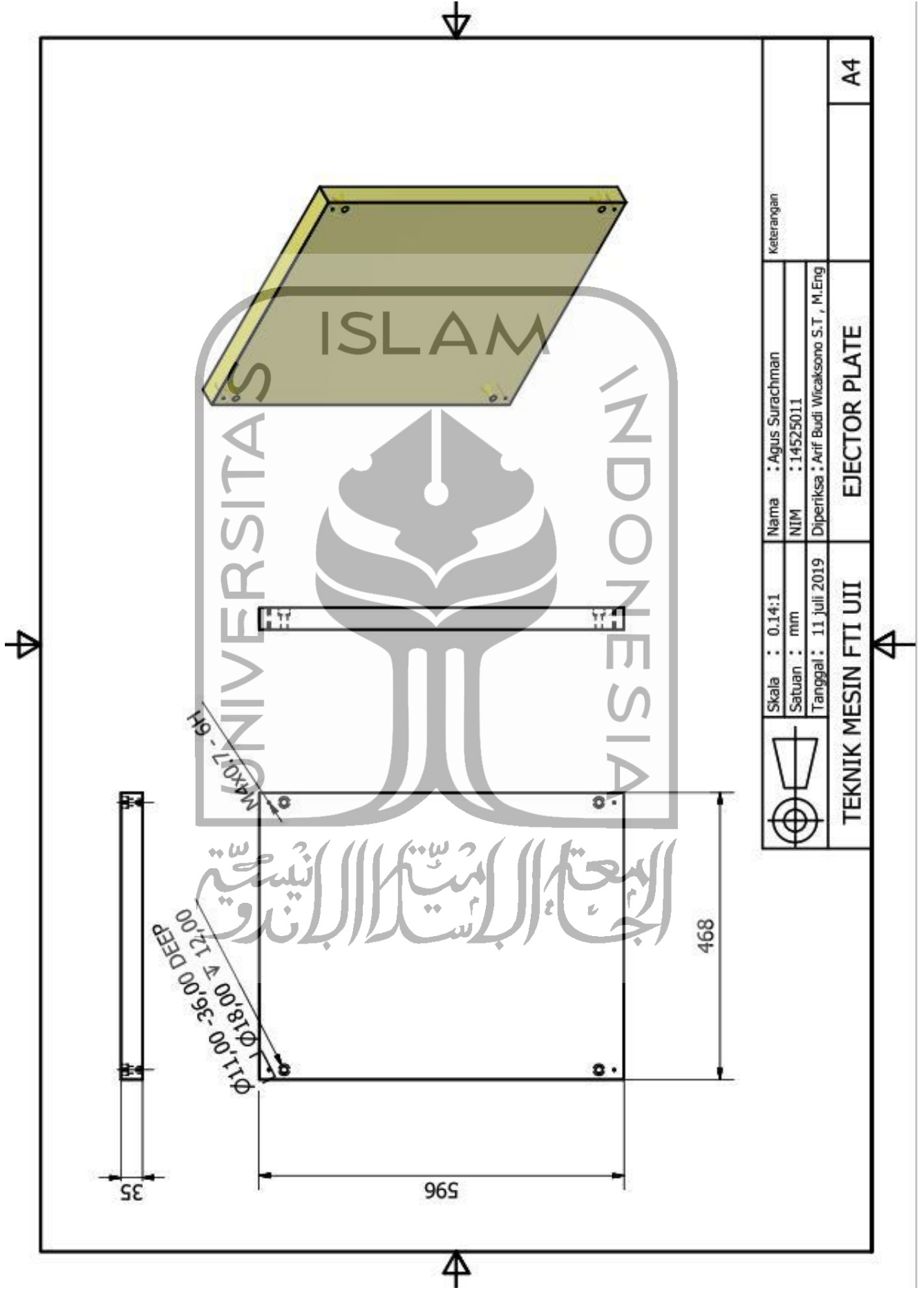

	Skala : 0.14:1	Nama : Agus Surachman	Keterangan
	Satuan : mm	NIM : 14525011	
	Tanggal : 11 juli 2019	Diperiksa : Arif Budi Wicaksono S.T., M.Eng	
TEKNIK MESIN FTI UII		EJECTOR PLATE	
		A4	

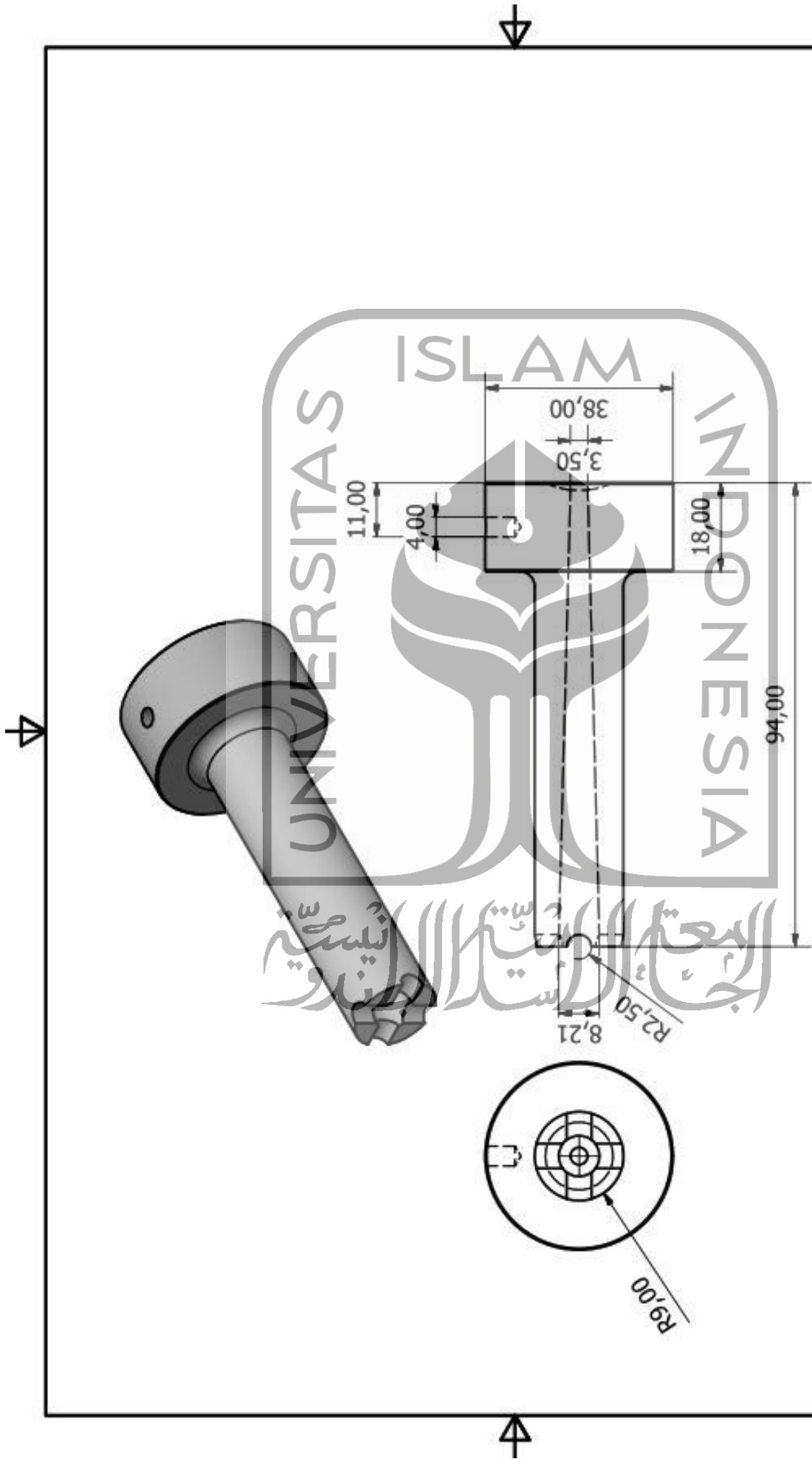

	Skala : 1 : 1	Nama : Agus Surachman	Keterangan
	Satuan : mm	NIM : 14525011	
Tanggal : 11 Juli 2019		Diperiksa : Arif Budi Wicaksono S.T., M.Eng	A4
TEKNIK MESIN FTI UII		Sprue Bushing	

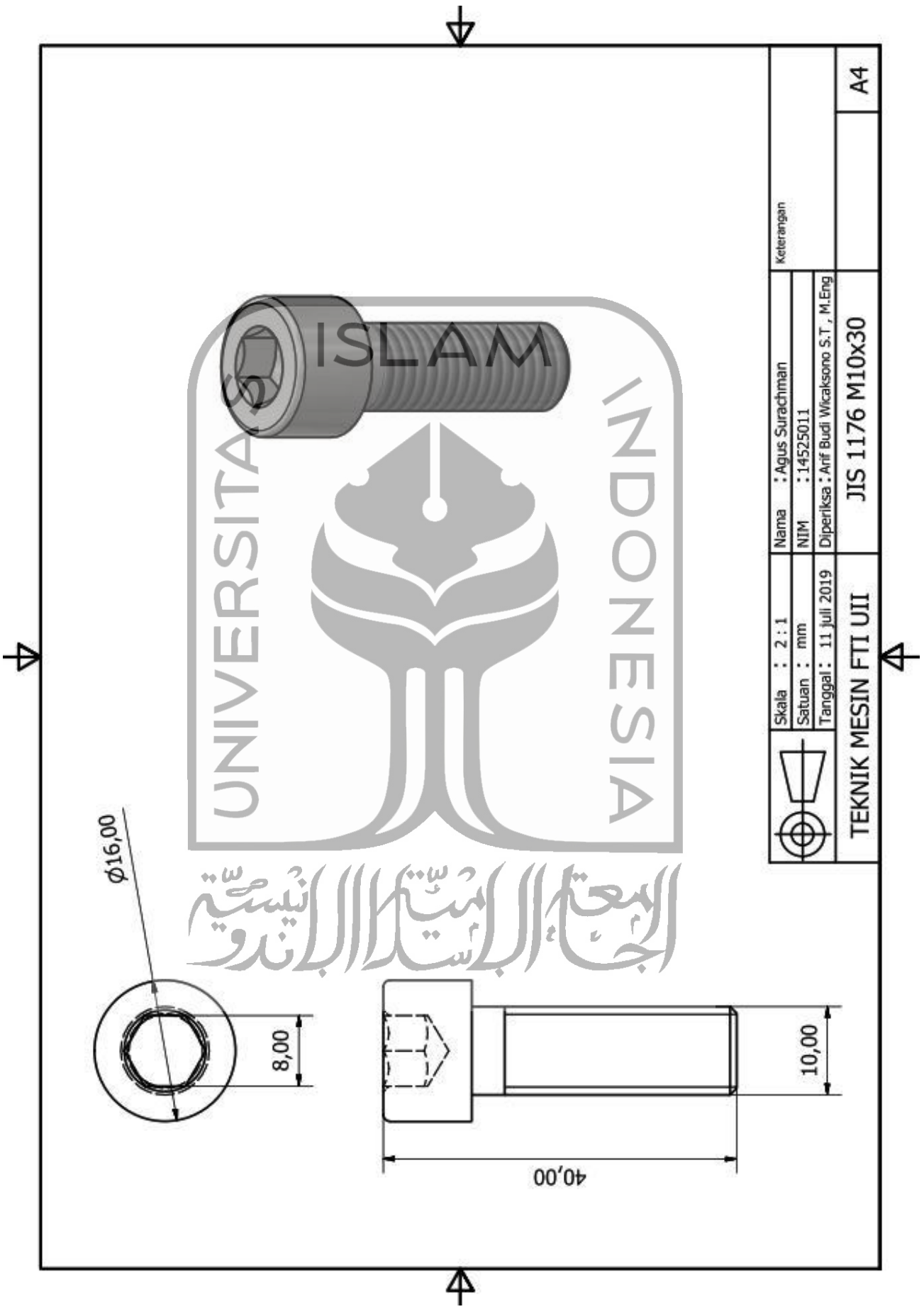

	Skala : 2 : 1	Nama : Agus Surachman	Keterangan
	Satuan : mm	NIM : 14525011	
	Tanggal : 11 Juli 2019	Diperiksa : Arif Budi Wicaksono S.T., M.Eng	
TEKNIK MESIN FTI UII		JIS 1176 M10x30	A4

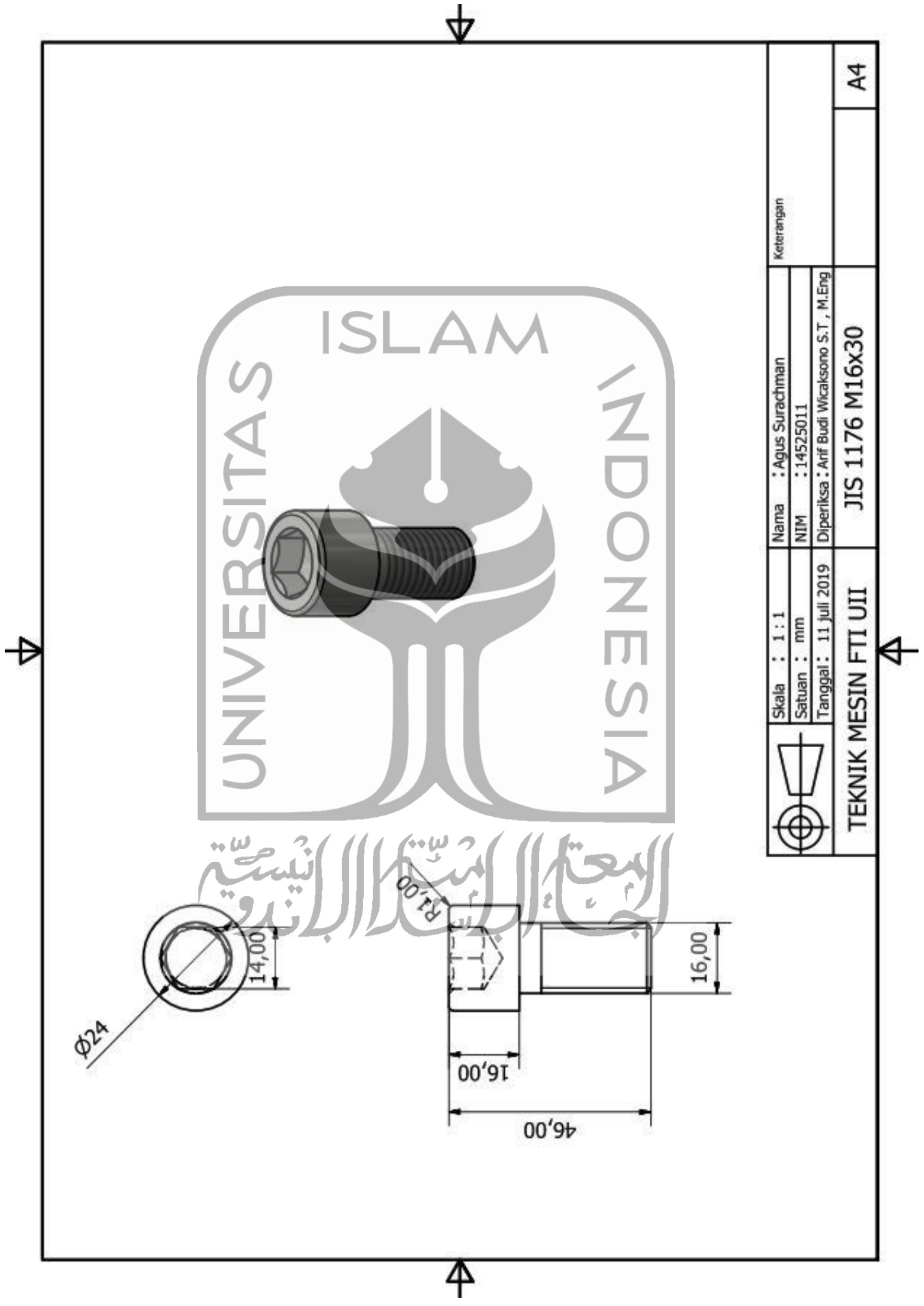

	Skala : 1 : 1	Nama : Agus Surachman	Keterangan
	Satuan : mm	NIM : 14525011	
	Tanggal : 11 juli 2019	Diperiksa : Arif Budi Wicaksono S.T., M.Eng	
TEKNIK MESIN FTI UII		JIS 1176 M16x30	A4

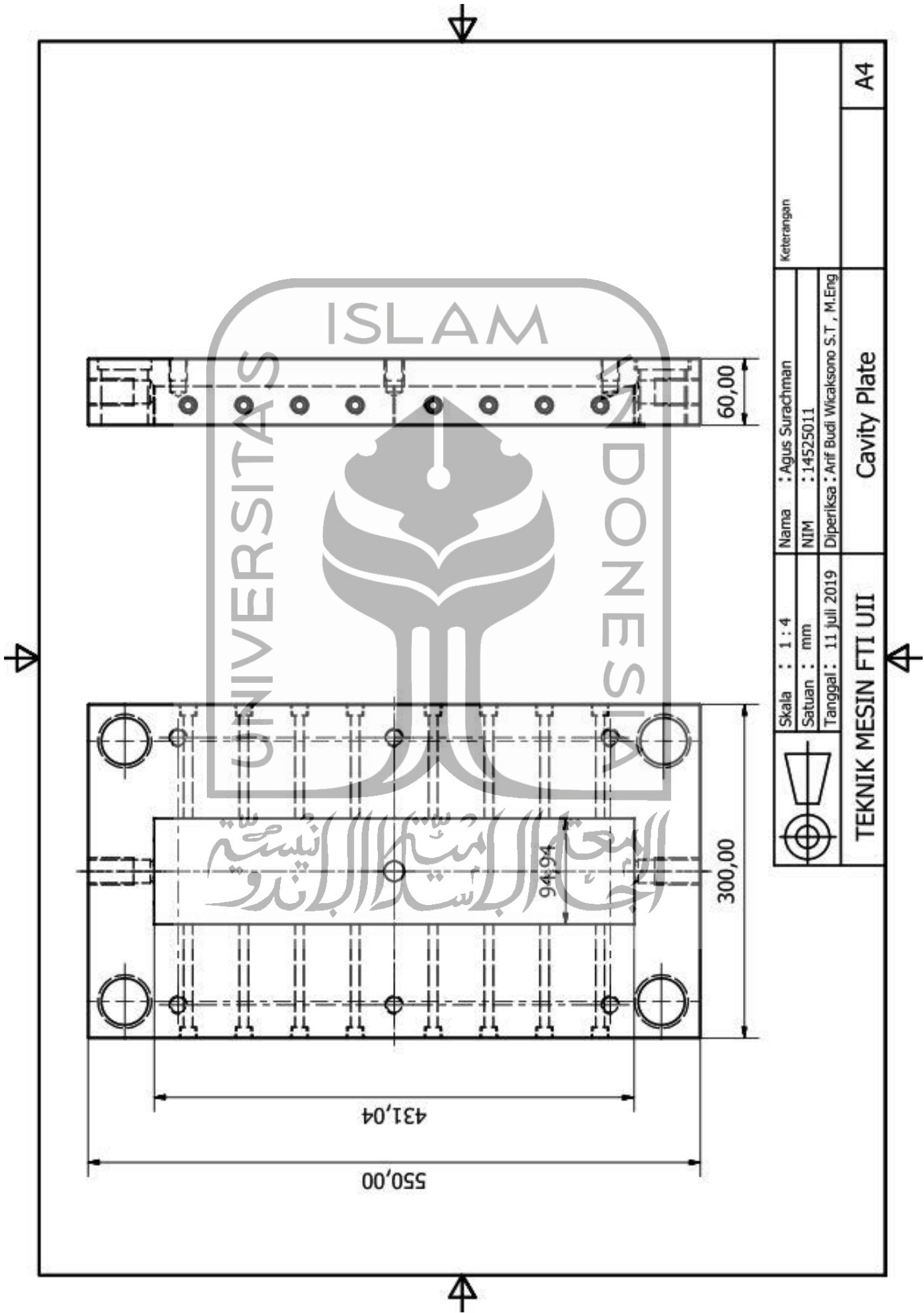

	Skala : 1 : 4	Nama : Agus Surachman	Keterangan
	Satuan : mm	NIM : 14525011	
	Tanggal : 11 Juli 2019	Diperiksa : Arif Budi Wicaksono S.T., M.Eng	
TEKNIK MESIN FTI UII		Cavity Plate	A4