

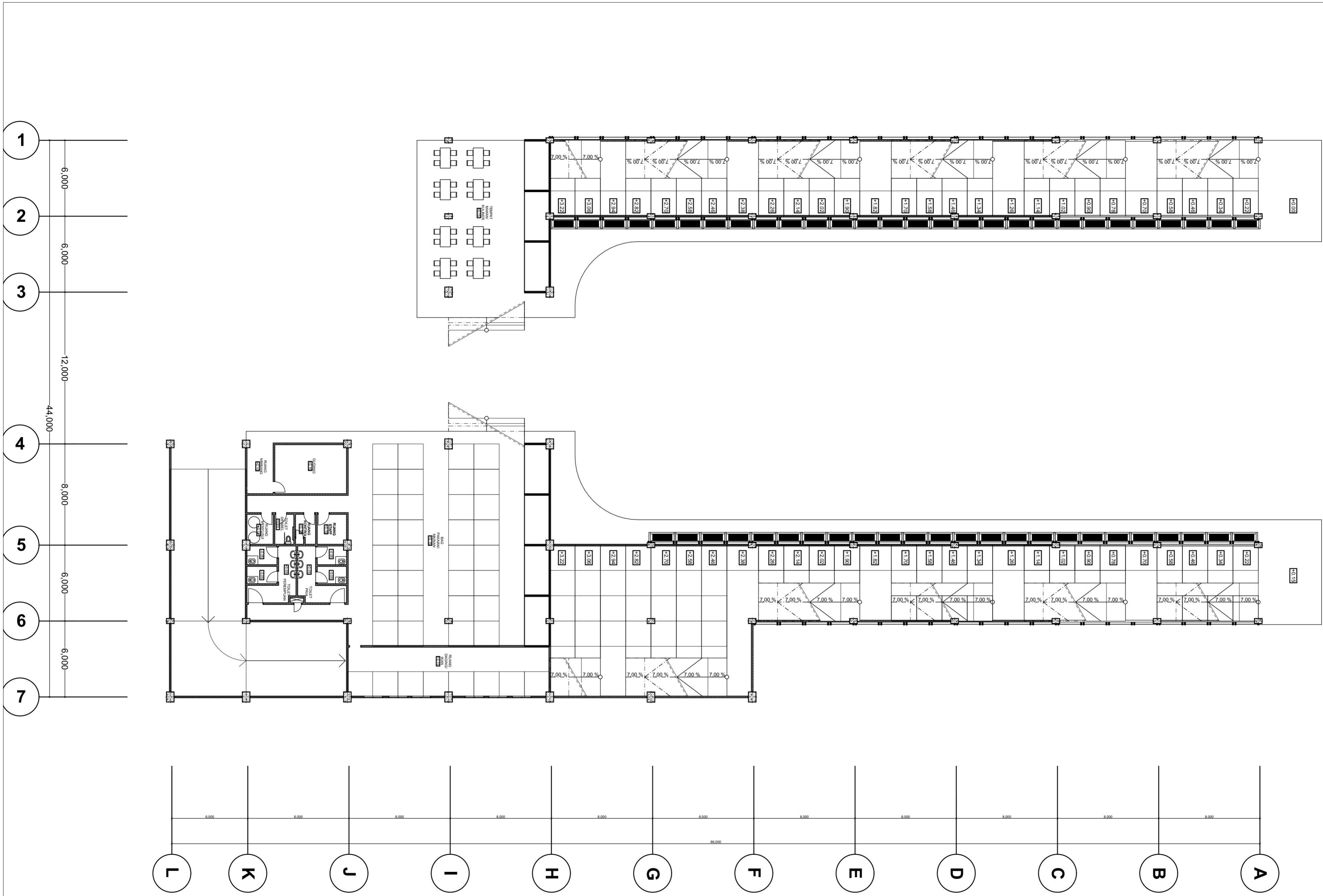

PLANNING CONSULTANT		
PROJECT		
RE-DESIGN PASAR LEMPUYANGAN YOGYAKARTA		
OWNER		
PT. LEMPUYANGAN		
CHIEF ARCHITECT	ID	
HAFIAN AKBAR	14512202	
TEAM NAME	ID	
IN HOUSE ARCHITECT		
CLIENT		
Syarifah Ismailiyah A., ST., MT., IAI		
DRAWING TITLE		
BASEMENT		
DRAWING BY HAFIAN AKBAR		
STATUS		
SCALE	1:200	FILE NO. A-02
	NAME	SIGN
DRAWN BY		
CHECKED BY		
REVIEWED & APPROVED BY		
DRAWING NO.		
DESCRIPTION		
APPROVAL		
△		
△		
△		
△		
REV		
NOTES		
PAGE	TOTAL	
INSTITUTION		
Departement of Architecture UNIVERSITAS ISLAM INDONESIA		

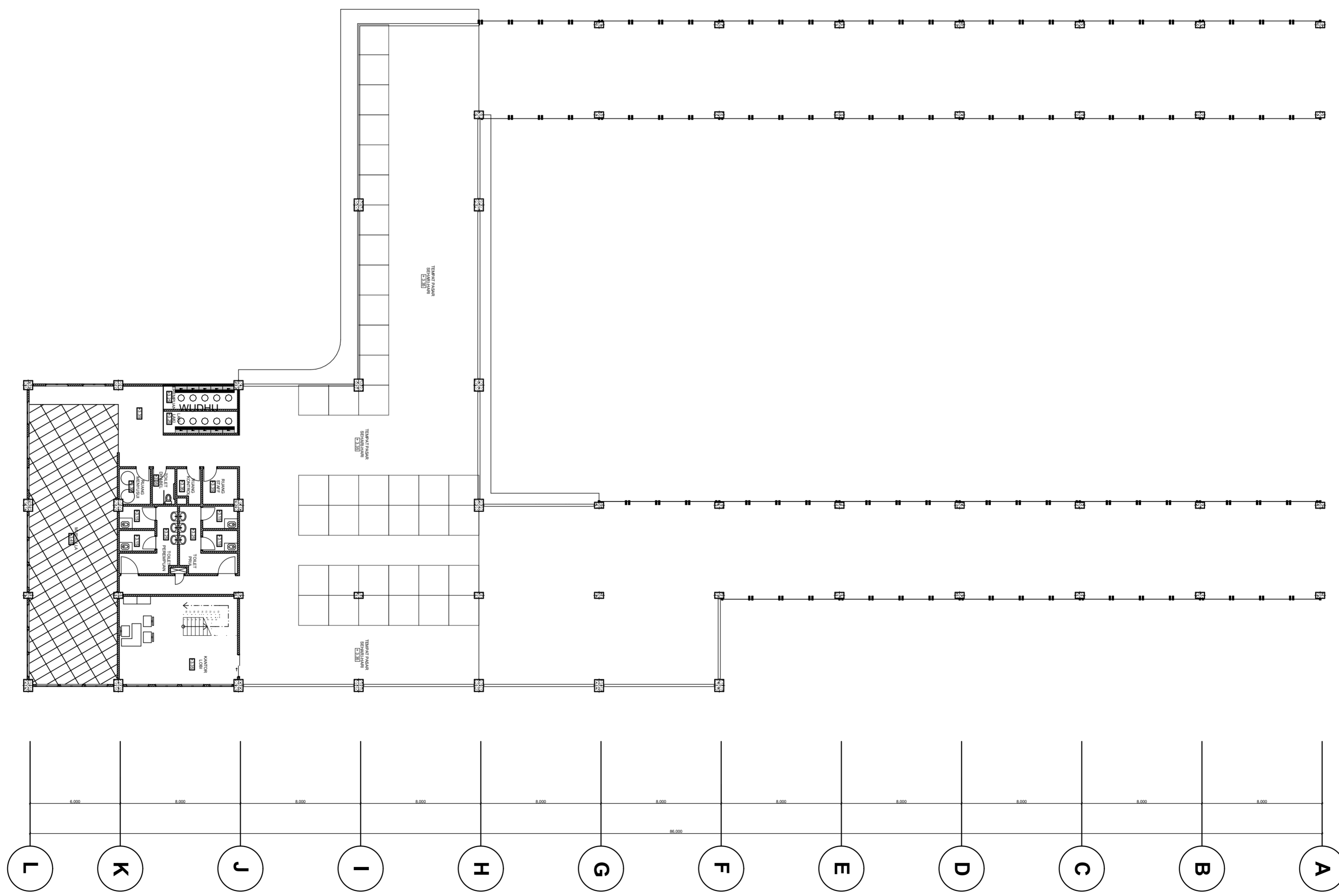



PLANNING CONSULTANT		
PROJECT		
RE-DESIGN PASAR LEMPUYANGAN YOGYAKARTA		
OWNER		
PT. LEMPUYANGAN		
CHIEF ARCHITECT	ID	
HAFIAN AKBAR	14512202	
TEAM NAME	ID	
IN HOUSE ARCHITECT		
CLIENT		
Syarifah Ismailiyah A., ST., MT., IAI		
DRAWING TITLE		
LT DASAR		
DRAWING BY HAFIAN AKBAR		
STATUS		
SCALE	1:200	FILE NO. A-03
	NAME	SIGN
		DATE
DRAWN BY		
CHECKED BY		
REVIEWED & APPROVED BY		
DRAWING NO.		
DESCRIPTION		
APPROVAL		
▲		
▲		
▲		
▲		
▲		
▲		
NOTES		
PAGE	TOTAL	
INSTITUTION		
Departement of Architecture UNIVERSITAS ISLAM INDONESIA		



PLANNING CONSULTANT	
PROJECT	
RE-DESIGN PASAR LEMPUYANGAN YOGYAKARTA	
OWNER	
PT. LEMPUYANGAN	
CHIEF ARCHITECT	ID
HAFIAN AKBAR	14512202
TEAM NAME	ID
IN HOUSE ARCHITECT	
CLIENT	
Syarifah Ismailiyah A., ST., MT., IAI	
DRAWING TITLE	
LT SATU	
DRAWING BY HAFIAN AKBAR	
STATUS	
SCALE	FILE NO.
1:200	A-04
	NAME SIGN DATE
DRAWN BY	
CHECKED BY	
REVIEWED & APPROVED BY	
DRAWING NO.	
DESCRIPTION	
APPROVAL	
△	
△	
△	
△	
△	
REV	
NOTES	
PAGE	TOTAL
INSTITUTION	
Departement of Architecture UNIVERSITAS ISLAM INDONESIA	
	

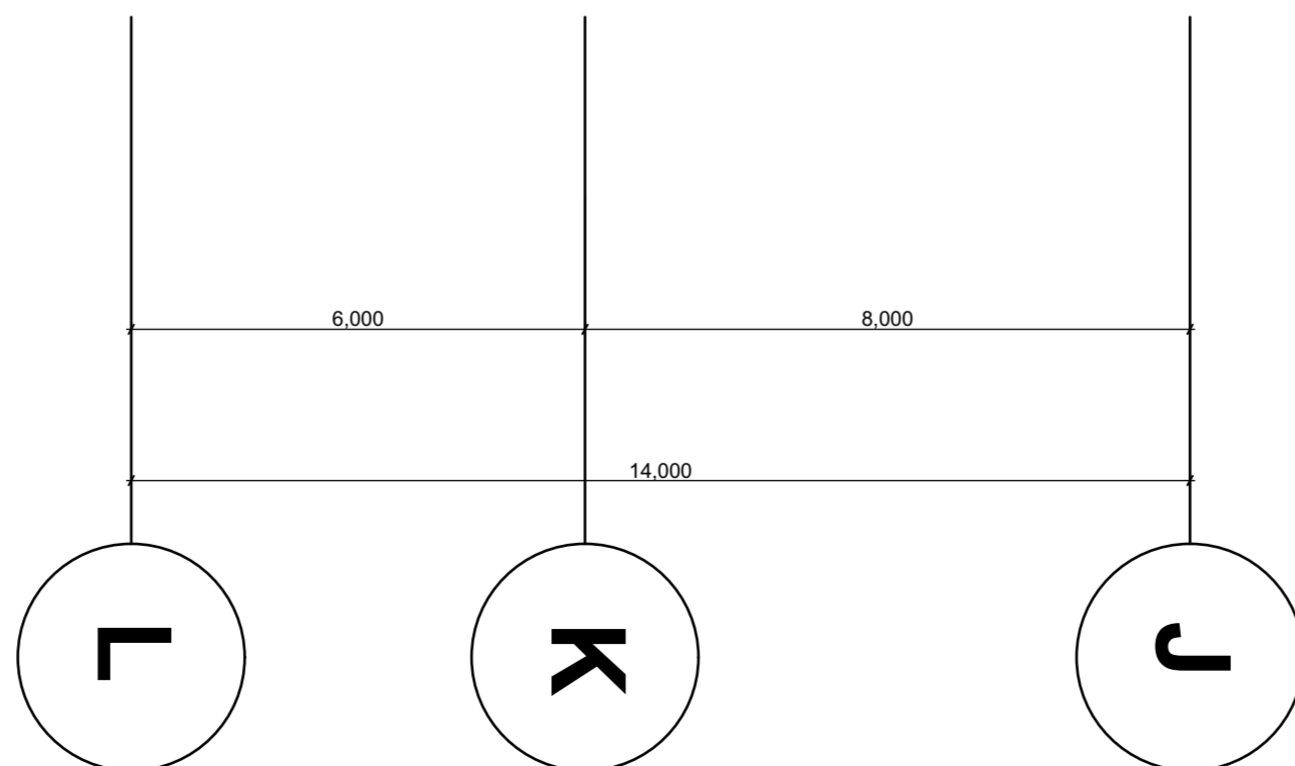
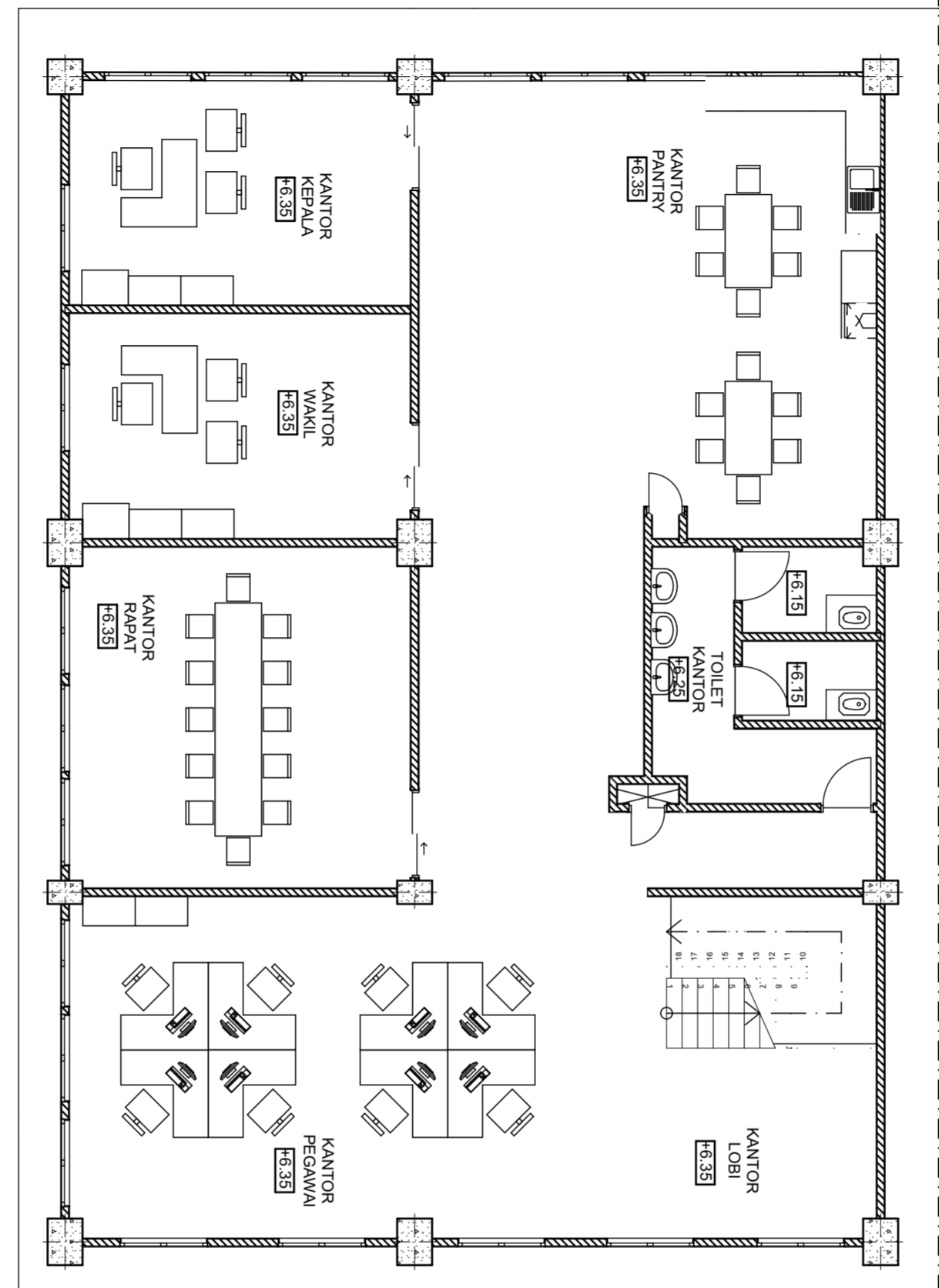
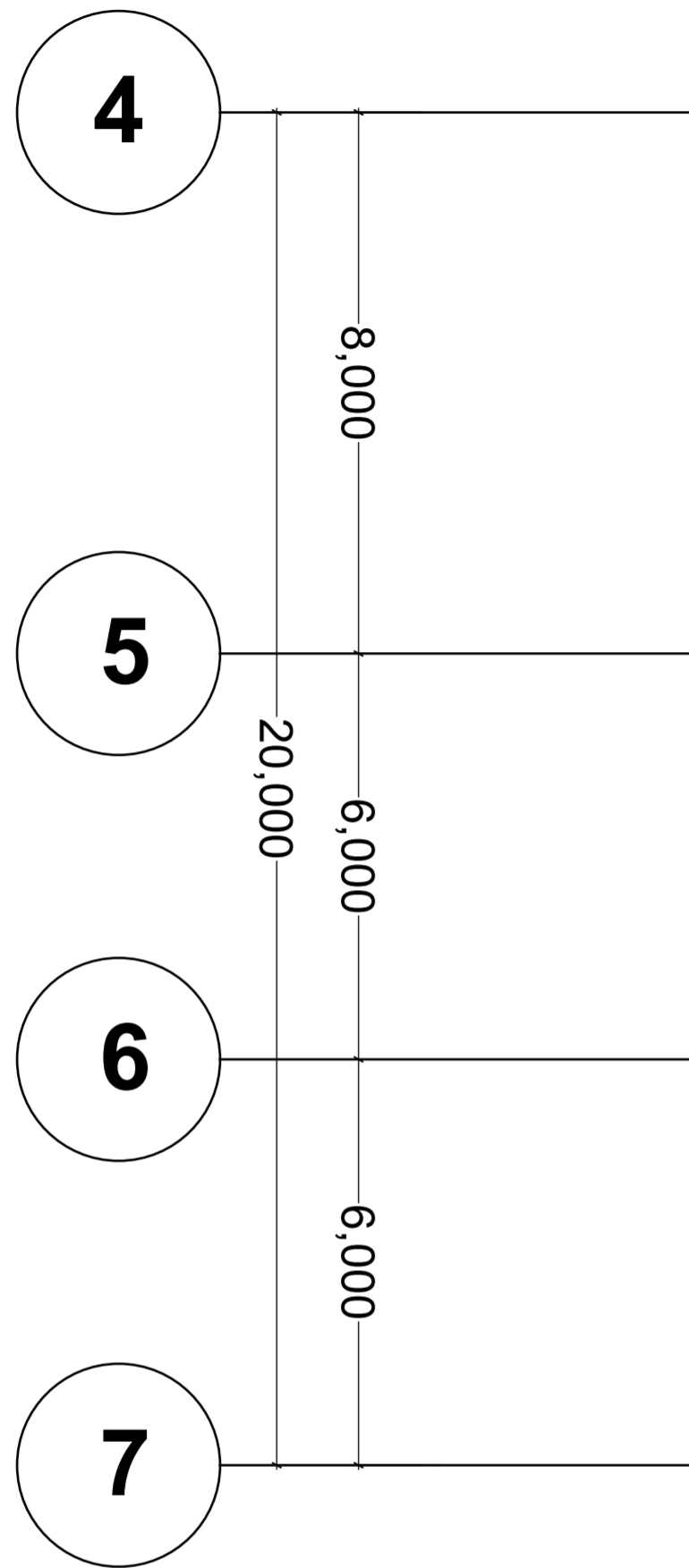

PLANNING CONSULTANT

PROJECT

RE-DESIGN PASAR LEMPUYANGAN
YOGYAKARTA

OWNER

PT. LEMPUYANGAN

CHIEF ARCHITECT ID

HAFIAN AKBAR 14512202

TEAM NAME ID

IN HOUSE ARCHITECT

CLIENT

Syarifah Ismailiyah A., ST., MT., IAI

DRAWING TITLE

LT DUA

DRAWING BY HAFIAN AKBAR

STATUS

SCALE 1:100 FILE NO. A-05

DRAWING NO.

DESCRIPTION

INSTITUTION
Departement of Architecture
UNIVERSITAS ISLAM INDONESIA



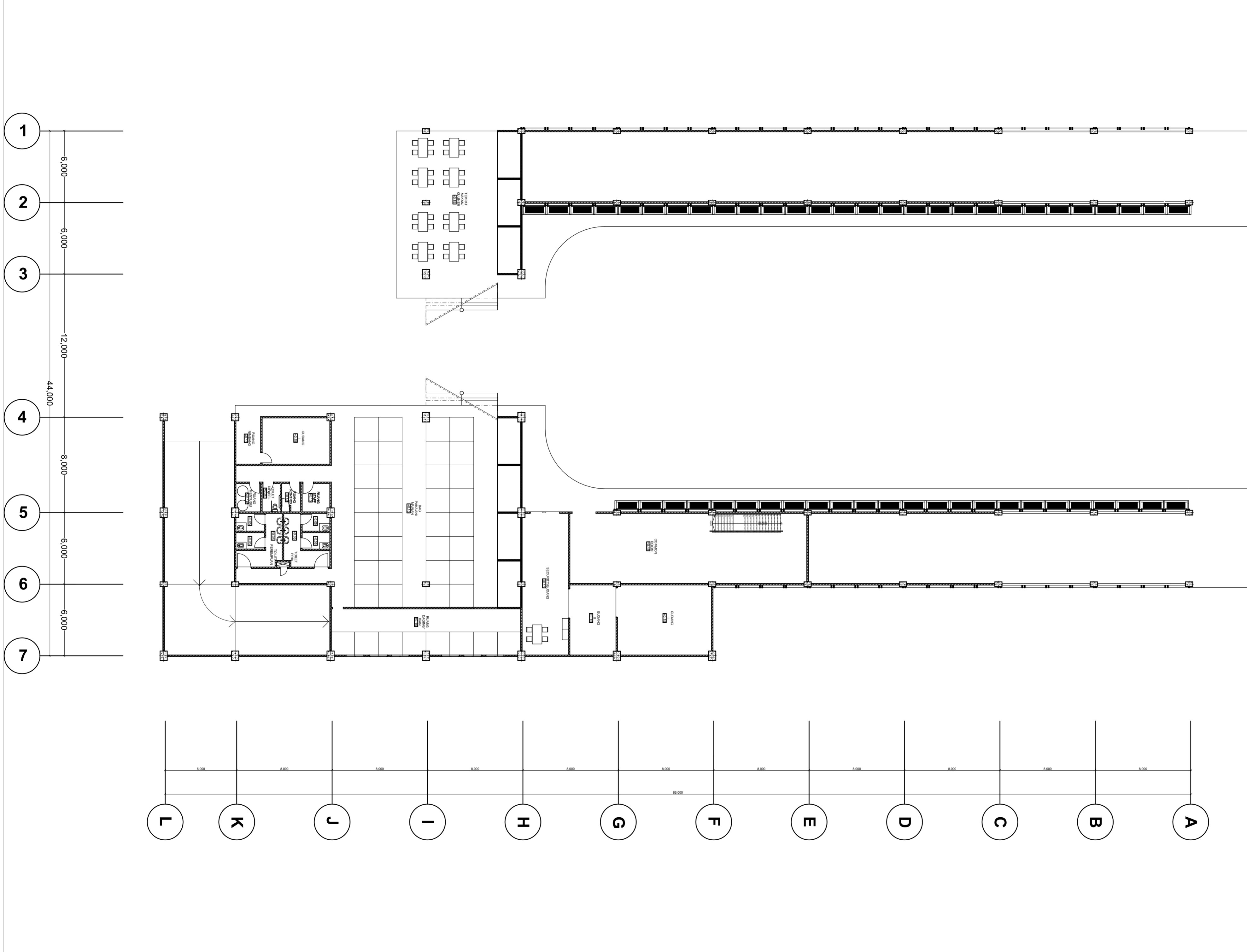

PLANNING CONSULTANT		
PROJECT		
RE-DESIGN PASAR LEMPUYANGAN YOGYAKARTA		
OWNER		
PT. LEMPUYANGAN		
CHIEF ARCHITECT	ID	
HAFIAN AKBAR	14512202	
TEAM NAME	ID	
IN HOUSE ARCHITECT		
CLIENT		
Syarifah Ismailiyah A., ST., MT., IAI		
DRAWING TITLE		
LT DASAR'		
DRAWING BY HAFIAN AKBAR		
STATUS		
SCALE	1:200	FILE NO. A-03'
	NAME	SIGN
		DATE
DRAWN BY		
CHECKED BY		
REVIEWED & APPROVED BY		
DRAWING NO.		
DESCRIPTION		
APPROVAL		
△		
△		
△		
△		
△		
REV		
NOTES		
PAGE	TOTAL	
INSTITUTION		
Departement of Architecture UNIVERSITAS ISLAM INDONESIA		

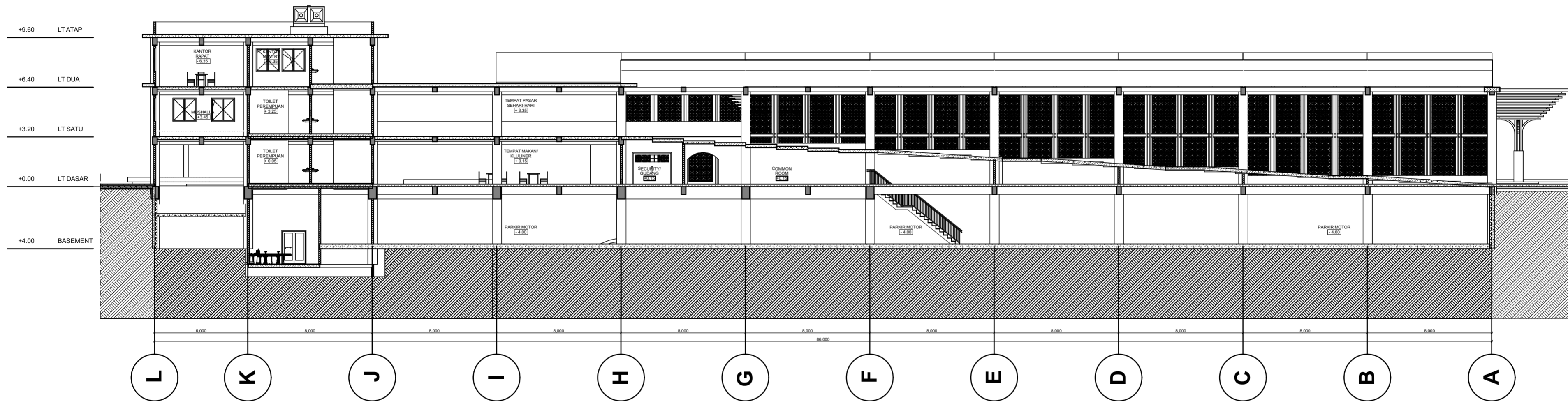

PLANNING
CONSULTANT

PROJECT

RE-DESIGN PASAR LEMPUYANGAN
YOGYAKARTA

OWNER

PT. LEMPUYANGAN

CHIEF ARCHITECT ID

HAFIAN AKBAR 14512202

TEAM NAME ID

IN HOUSE ARCHITECT

CLIENT

Syarifah Ismailiyah A., ST., MT., IAI

DRAWING TITLE

POTONGAN AA'

DRAWING BY HAFIAN AKBAR

STATUS

SCALE 1:200 FILE NO. A-06

NAME SIGN DATE

DRAWN BY

CHECKED BY

REVIEWED & APPROVED BY

DRAWING NO.

DESCRIPTION

APPROVAL

△		
△		
△		
△		
△		
REV		

NOTES

PAGE TOTAL

INSTITUTION
Departement of Architecture
UNIVERSITAS ISLAM INDONESIA



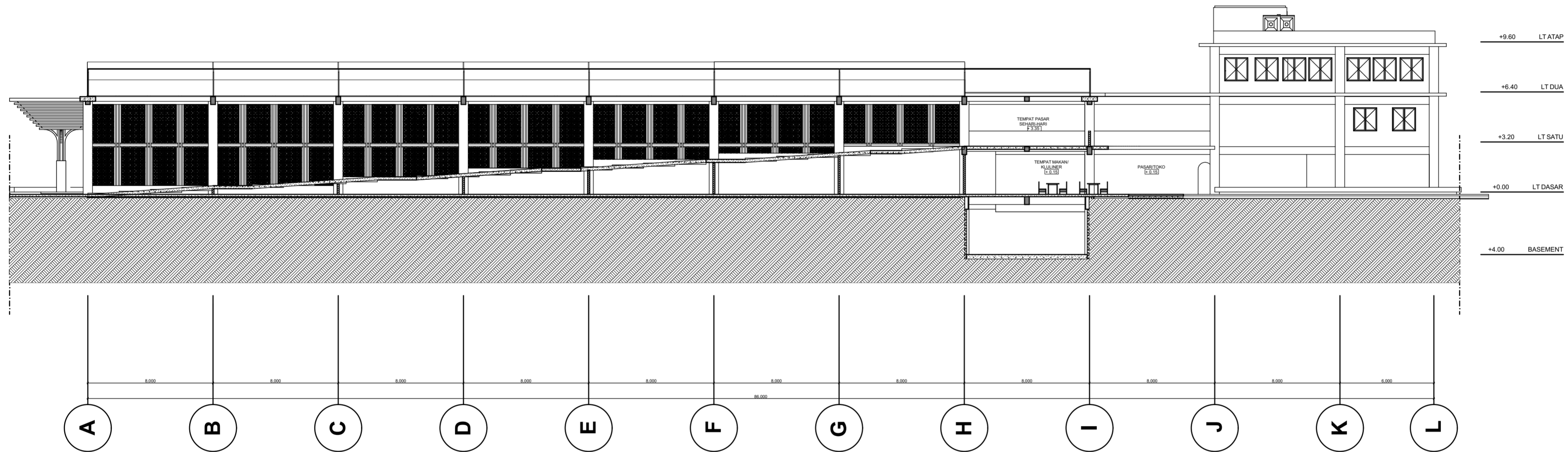

PLANNING CONSULTANT

PROJECT

RE-DESIGN PASAR LEMPUYANGAN
YOGYAKARTA

OWNER

PT. LEMPUYANGAN

CHIEF ARCHITECT ID

HAFIAN AKBAR 14512202

TEAM NAME ID

IN HOUSE ARCHITECT

CLIENT

Syarifah Ismailiyah A., ST., MT., IAI

DRAWING TITLE

POTONGAN BB'

DRAWING BY HAFIAN AKBAR

STATUS

SCALE 1:200 FILE NO. A-07

DRAWN BY

CHECKED BY

REVIEWED & APPROVED BY

DRAWING NO.

DESCRIPTION

APPROVAL

△			
△			
△			
△			
△			
REV			

NOTES

PAGE TOTAL

INSTITUTION

Departement of Architecture
UNIVERSITAS ISLAM INDONESIA



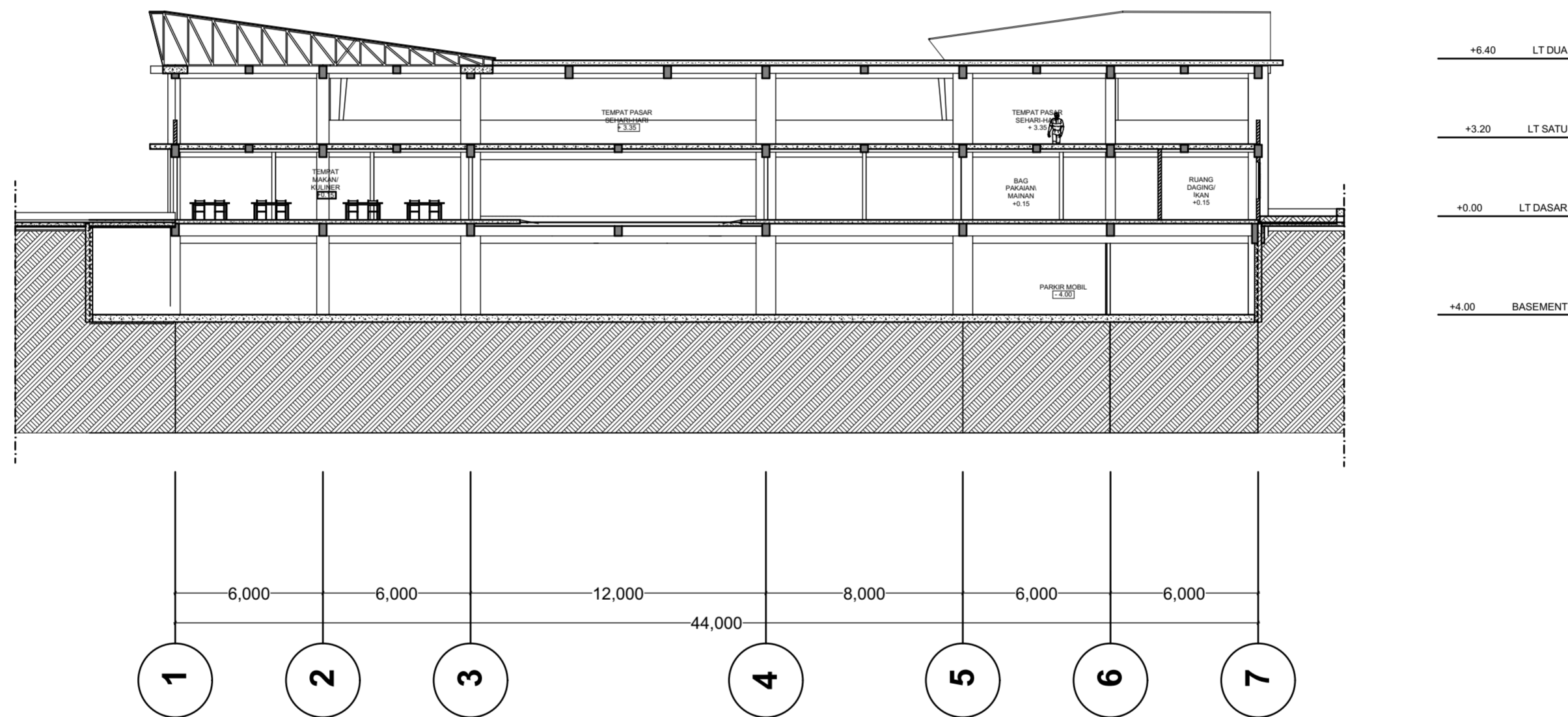

PLANNING CONSULTANT		
PROJECT		
RE-DESIGN PASAR LEMPUYANGAN YOGYAKARTA		
OWNER		
PT. LEMPUYANGAN		
CHIEF ARCHITECT	ID	
HAFIAN AKBAR	14512202	
TEAM NAME	ID	
IN HOUSE ARCHITECT		
CLIENT		
Syarifah Ismailiyah A., ST., MT., IAI		
DRAWING TITLE		
POTONGAN CC'		
DRAWING BY HAFIAN AKBAR		
STATUS		
SCALE	1:200	FILE NO. A-08
	NAME	SIGN
	DATE	
DRAWN BY		
CHECKED BY		
REVIEWED & APPROVED BY		
DRAWING NO.		
DESCRIPTION		
APPROVAL		
△		
△		
△		
△		
△		
△		
REV		
NOTES		
PAGE	TOTAL	
INSTITUTION		
Departement of Architecture		
UNIVERSITAS ISLAM INDONESIA		



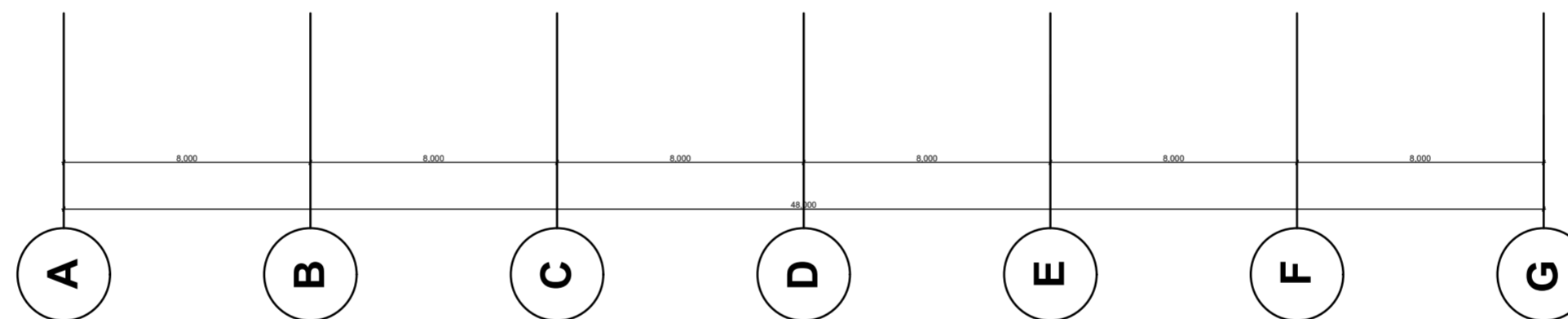
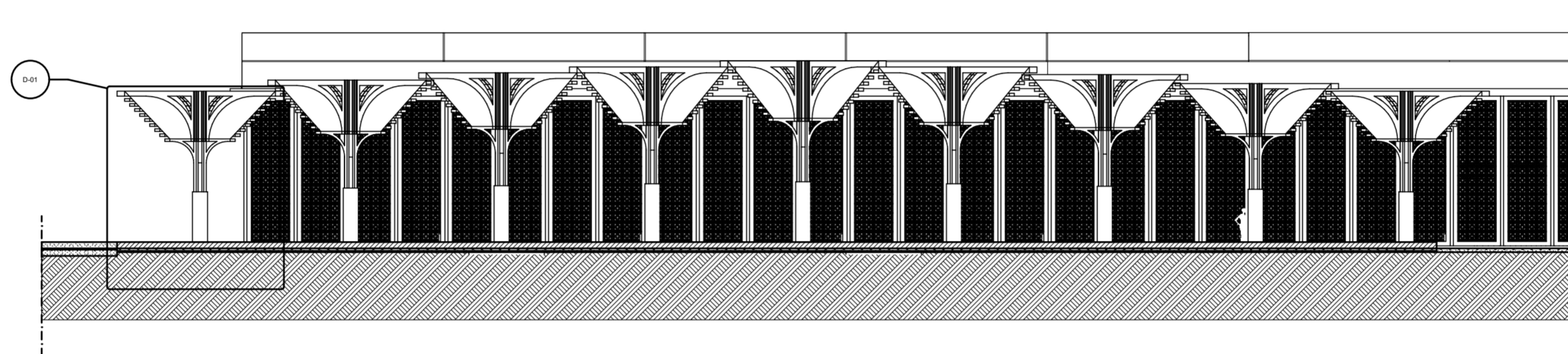

PLANNING
CONSULTANT

PROJECT

RE-DESIGN PASAR LEMPUYANGAN
YOGYAKARTA

OWNER

PT. LEMPUYANGAN

CHIEF ARCHITECT ID

HAFIAN AKBAR 14512202

TEAM NAME ID

IN HOUSE ARCHITECT

CLIENT

Syarifah Ismailiyah A., ST., MT., IAI

DRAWING TITLE

POTONGAN DD'

DRAWING BY HAFIAN AKBAR

STATUS

SCALE 1:200 FILE NO. A-09

NAME	SIGN	DATE

DRAWN BY

CHECKED BY

REVIEWED & APPROVED BY

DRAWING NO.



DESCRIPTION

APPROVAL

△			
△			
△			
△			
△			
△			
REV			

NOTES

PAGE	TOTAL

INSTITUTION
Departement of Architecture
UNIVERSITAS ISLAM INDONESIA



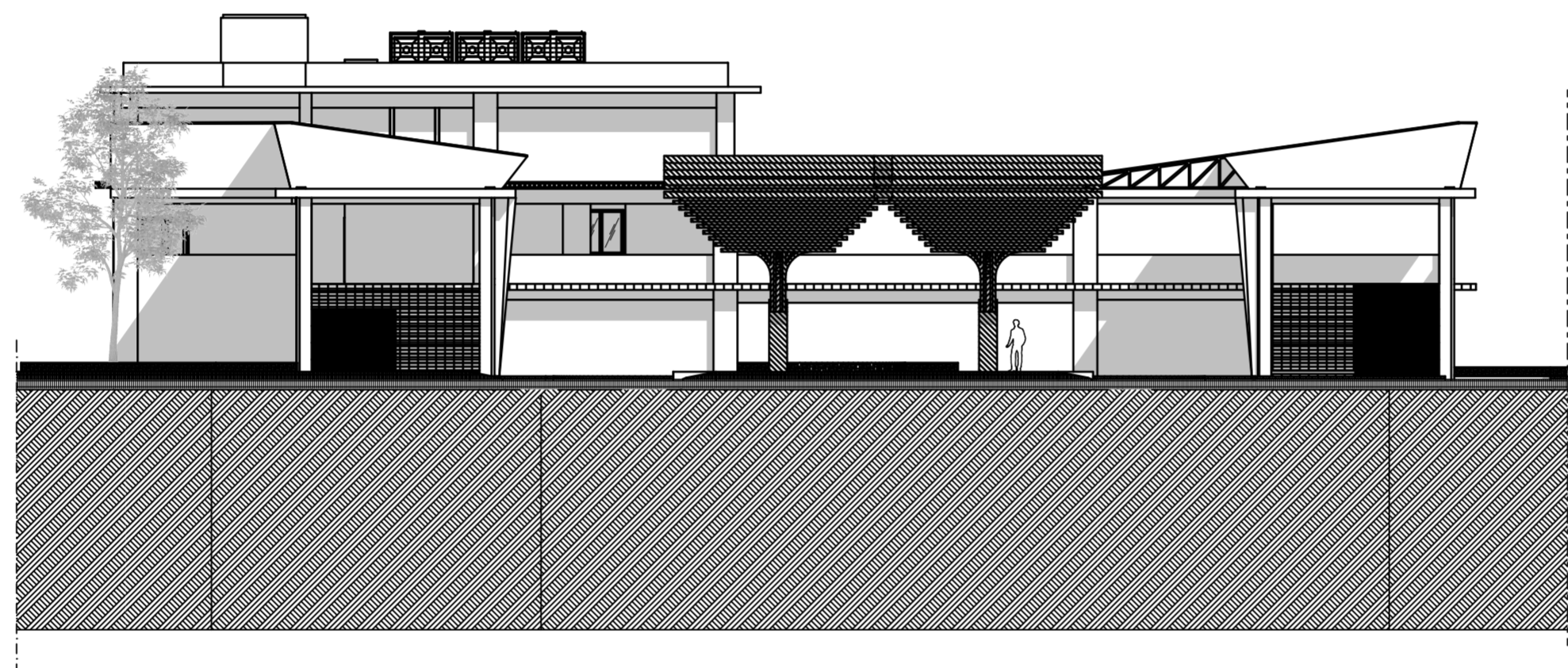

PLANNING
CONSULTANT

PROJECT

RE-DESIGN PASAR LEMPUYANGAN
YOGYAKARTA

OWNER

PT. LEMPUYANGAN

CHIEF ARCHITECT ID

HAFIAN AKBAR 14512202

TEAM NAME ID

IN HOUSE ARCHITECT

CLIENT

Syarifah Ismailiyah A., ST., MT., IAI

DRAWING TITLE

TAMPAK DEPAN

DRAWING BY HAFIAN AKBAR

STATUS

SCALE 1:200 FILE NO. A-10

NAME	SIGN	DATE

DRAWN BY

CHECKED BY

REVIEWED & APPROVED BY

DRAWING NO.



DESCRIPTION

APPROVAL

△			
△			
△			
△			
△			
REV			

NOTES

PAGE	TOTAL

INSTITUTION
Departement of Architecture
UNIVERSITAS ISLAM INDONESIA



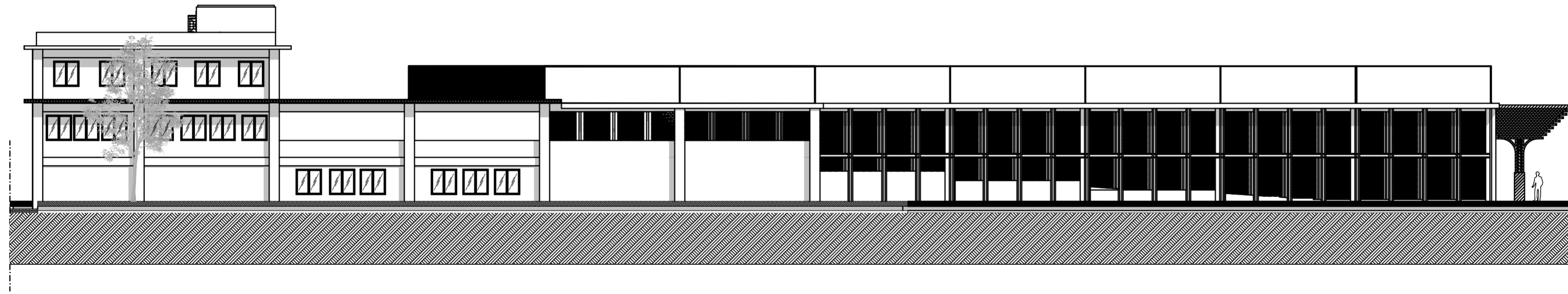

PLANNING
CONSULTANT

PROJECT

RE-DESIGN PASAR LEMPUYANGAN
YOGYAKARTA

OWNER

PT. LEMPUYANGAN

CHIEF ARCHITECT ID

HAFIAN AKBAR 14512202

TEAM NAME ID

IN HOUSE ARCHITECT

CLIENT

Syarifah Ismailiyah A., ST., MT., IAI

DRAWING TITLE

TAMPAK KANAN

DRAWING BY HAFIAN AKBAR

STATUS

SCALE 1:200

FILE NO. A-11

DRAWN BY NAME SIGN DATE

CHECKED BY

REVIEWED & APPROVED BY

DRAWING NO.



DESCRIPTION

APPROVAL

△			
△			
△			
△			
△			
△			
REV			

NOTES

PAGE

TOTAL

INSTITUTION
Departement of Architecture
UNIVERSITAS ISLAM INDONESIA



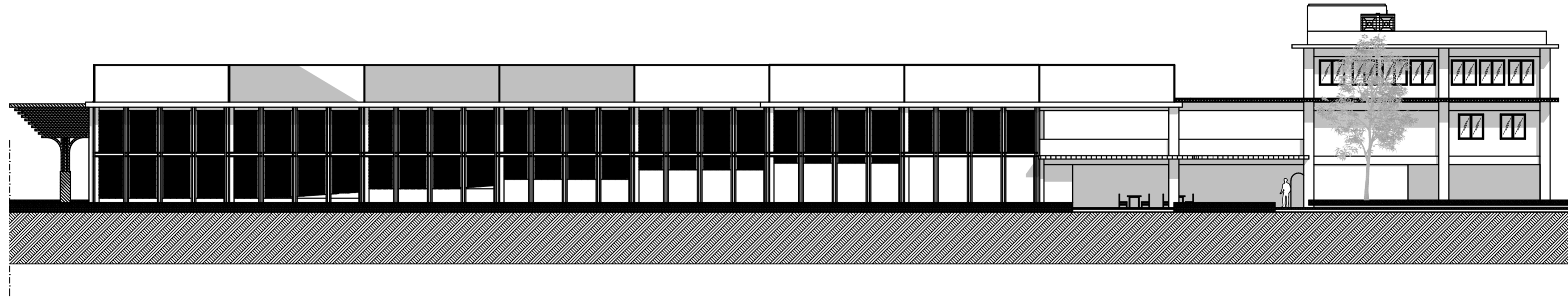

PLANNING
CONSULTANT

PROJECT

RE-DESIGN PASAR LEMPUYANGAN
YOGYAKARTA

OWNER

PT. LEMPUYANGAN

CHIEF ARCHITECT ID

HAFIAN AKBAR 14512202

TEAM NAME ID

IN HOUSE ARCHITECT

CLIENT

Syarifah Ismailiyah A., ST., MT., IAI

DRAWING TITLE

TAMPAK KIRI

DRAWING BY HAFIAN AKBAR

STATUS

SCALE 1:200

FILE NO. A-12

NAME SIGN DATE

DRAWN BY

CHECKED BY

REVIEWED & APPROVED BY

DRAWING NO.



DESCRIPTION

APPROVAL

△			
△			
△			
△			
△			
△			
REV			

NOTES

PAGE

TOTAL

INSTITUTION
Departement of Architecture
UNIVERSITAS ISLAM INDONESIA



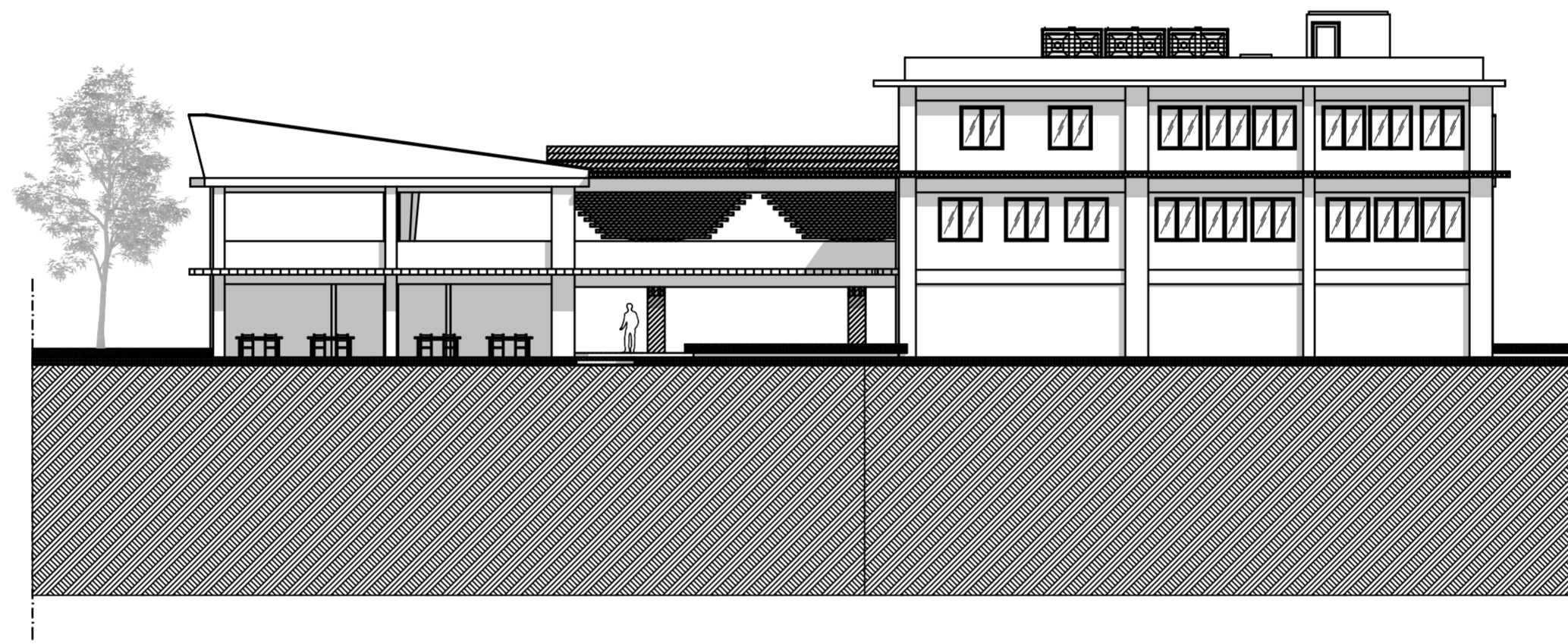

PLANNING
CONSULTANT

PROJECT

RE-DESIGN PASAR LEMPUYANGAN
YOGYAKARTA

OWNER

PT. LEMPUYANGAN

CHIEF ARCHITECT ID

HAFIAN AKBAR 14512202

TEAM NAME ID

IN HOUSE ARCHITECT

CLIENT

Syarifah Ismailiyah A., ST., MT., IAI

DRAWING TITLE

TAMPAK
BELAKANG

DRAWN BY HAFIAN AKBAR

STATUS

SCALE 1:200 FILE NO. A-13

NAME	SIGN	DATE

DRAWN BY

CHECKED BY

REVIEWED & APPROVED BY

DRAWING NO.



DESCRIPTION

APPROVAL

△			
△			
△			
△			
△			
△			
REV			

NOTES

PAGE	TOTAL

INSTITUTION
Departement of Architecture
UNIVERSITAS ISLAM INDONESIA

