

PLANNING CONSULTANT		
PROJECT		
RE-DESIGN PASAR LEMPUYANGAN YOGYAKARTA		
OWNER		
PT. LEMPUYANGAN		
CHIEF ARCHITECT	ID	
HAFIAN AKBAR	14512202	
TEAM NAME	ID	
IN HOUSE ARCHITECT		
CLIENT		
Syarifah Ismailiyah A., ST., MT., IAI		
DRAWING TITLE		
SITEPLAN		
DRAWING BY HAFIAN AKBAR		
STATUS		
SCALE	1:250	FILE NO. A-01
	NAME	SIGN
		DATE
DRAWN BY		
CHECKED BY		
REVIEWED & APPROVED BY		
DRAWING NO.		
DESCRIPTION		
APPROVAL		
△		
△		
△		
△		
△		
REV		
NOTES		
PAGE	TOTAL	
INSTITUTION		
Departement of Architecture UNIVERSITAS ISLAM INDONESIA		

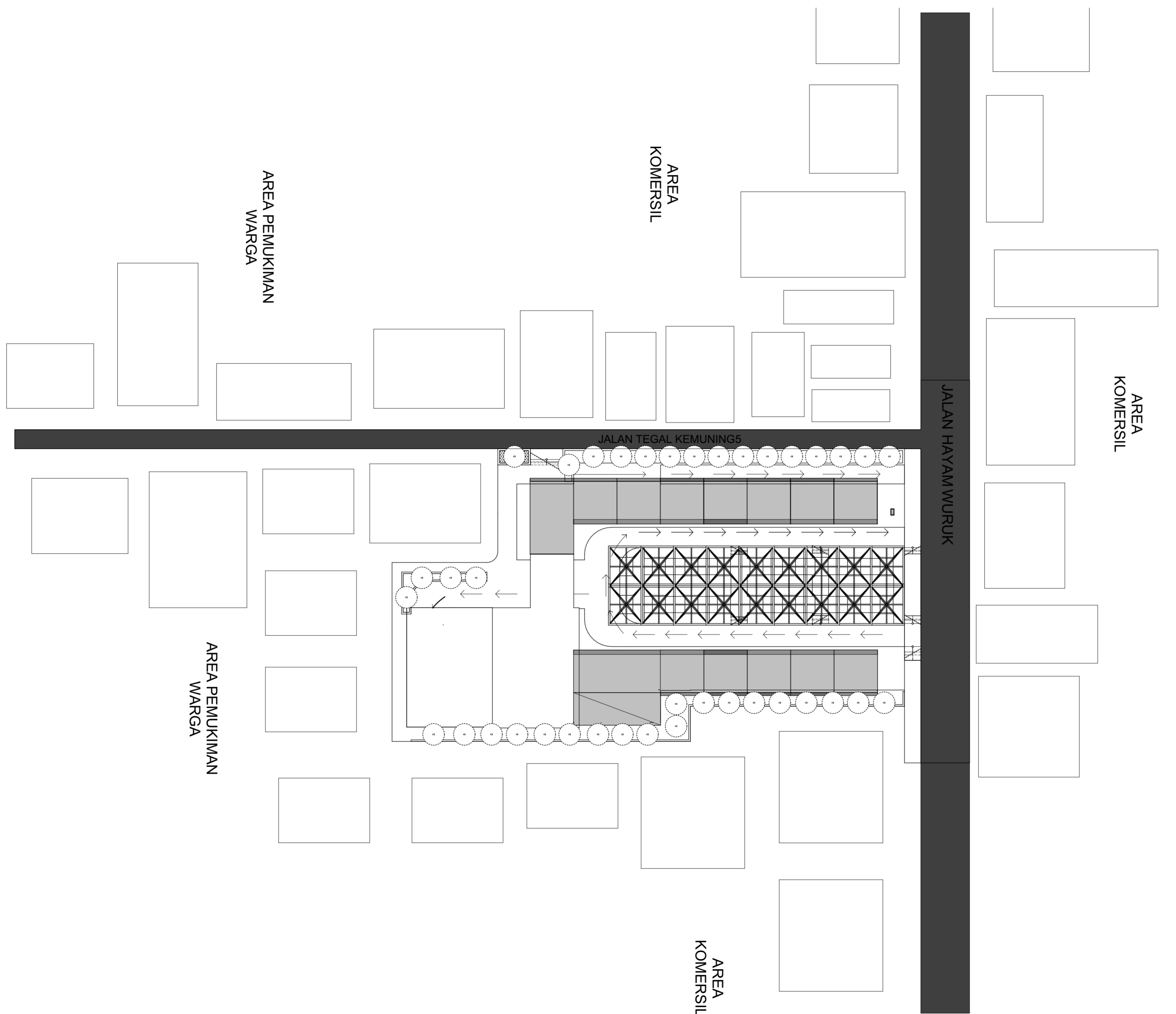

PLANNING CONSULTANT		
PROJECT		
RE-DESIGN PASAR LEMPUYANGAN YOGYAKARTA		
OWNER		
PT. LEMPUYANGAN		
CHIEF ARCHITECT	ID	
HAFIAN AKBAR	14512202	
TEAM NAME	ID	
IN HOUSE ARCHITECT		
CLIENT		
Syarifah Ismailiyah A., ST., MT., IAI		
DRAWING TITLE		
SITUASI		
DRAWING BY HAFIAN AKBAR		
STATUS		
SCALE	1:500	FILE NO. A-00
	NAME	SIGN DATE
DRAWN BY		
CHECKED BY		
REVIEWED & APPROVED BY		
DRAWING NO.		
DESCRIPTION		
APPROVAL		
△		
△		
△		
△		
△		
△		
REV		
NOTES		
PAGE	TOTAL	
INSTITUTION		
Departement of Architecture UNIVERSITAS ISLAM INDONESIA		

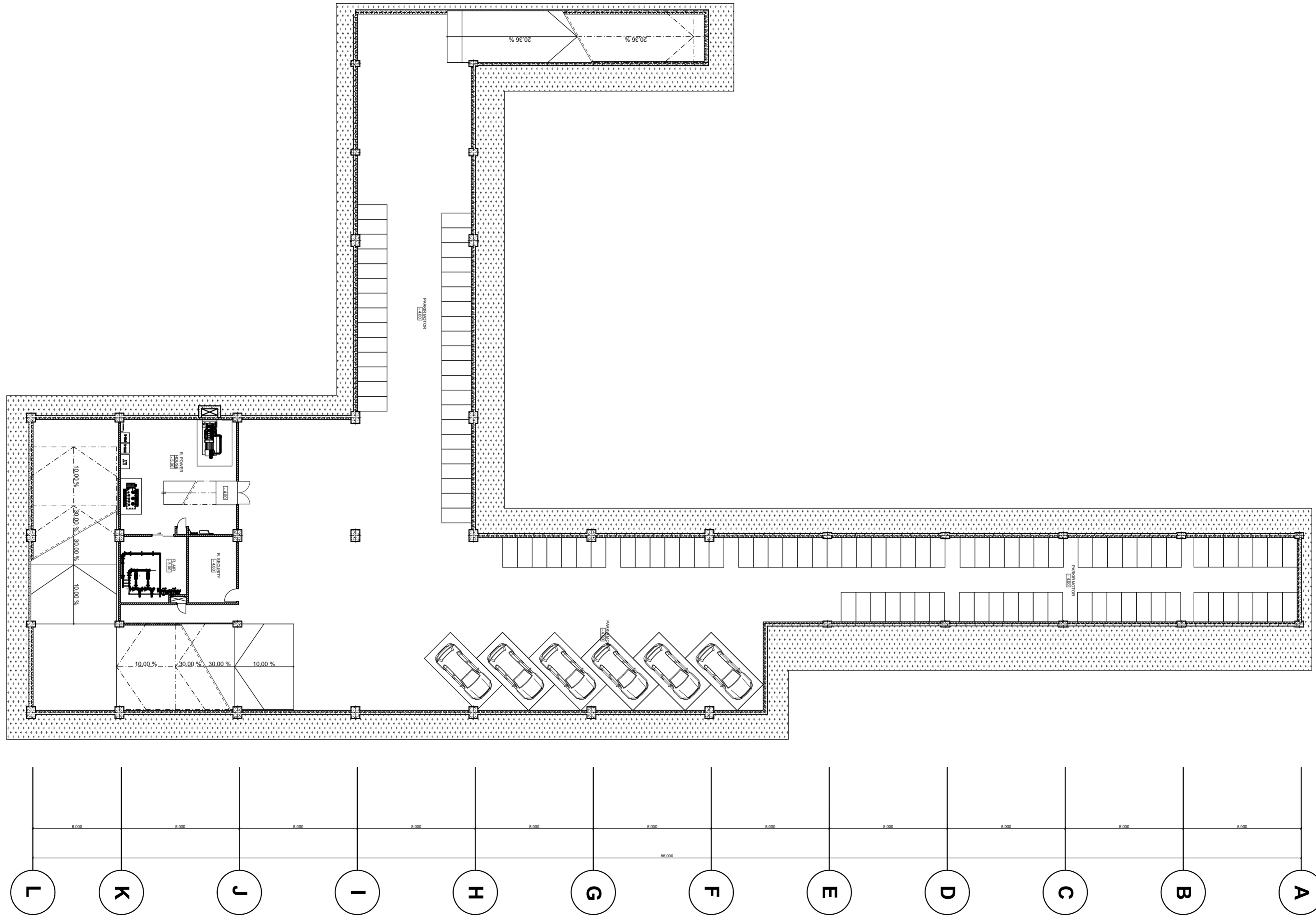

PLANNING CONSULTANT		
PROJECT		
RE-DESIGN PASAR LEMPUYANGAN YOGYAKARTA		
OWNER		
PT. LEMPUYANGAN		
CHIEF ARCHITECT	ID	
HAFIAN AKBAR	14512202	
TEAM NAME	ID	
IN HOUSE ARCHITECT		
CLIENT		
Syarifah Ismailiyah A., ST., MT., IAI		
DRAWING TITLE		
BASEMENT		
DRAWING BY HAFIAN AKBAR		
STATUS		
SCALE	1:200	FILE NO. A-02
	NAME	SIGN
DRAWN BY		DATE
CHECKED BY		
REVIEWED & APPROVED BY		
DRAWING NO.		
DESCRIPTION		
APPROVAL		
△		
△		
△		
△		
△		
REV		
NOTES		
PAGE	TOTAL	
INSTITUTION		
Departement of Architecture UNIVERSITAS ISLAM INDONESIA		

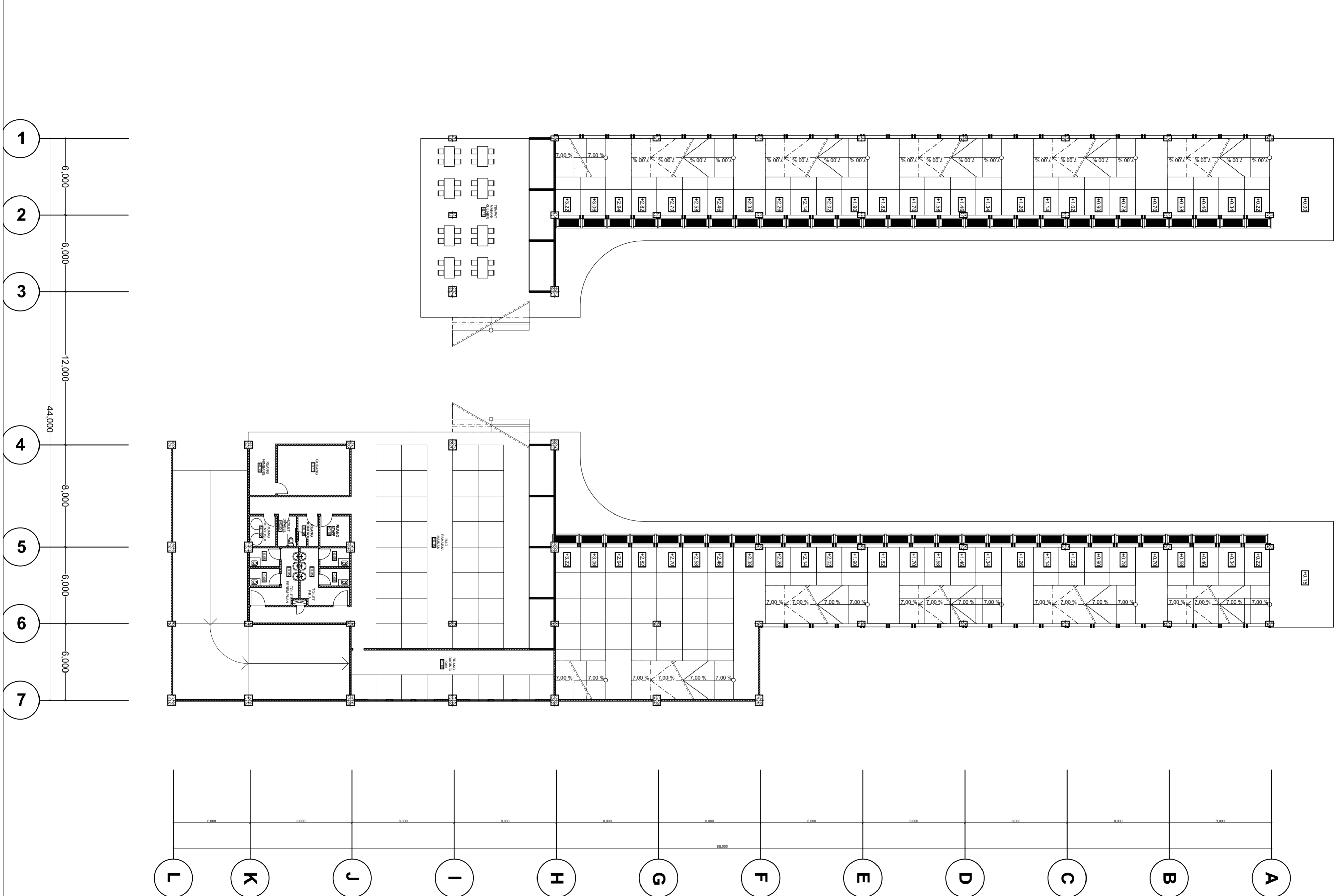

PLANNING CONSULTANT			
PROJECT			
RE-DESIGN PASAR LEMPUYANGAN YOGYAKARTA			
OWNER			
PT. LEMPUYANGAN			
CHIEF ARCHITECT		ID	
HAFIAN AKBAR		14512202	
TEAM NAME		ID	
IN HOUSE ARCHITECT			
CLIENT			
Syarifah Ismailiyah A., ST., MT., IAI			
DRAWING TITLE			
LT DASAR			
DRAWING BY HAFIAN AKBAR			
STATUS			
SCALE	1:200	FILE NO. A-03	
	NAME	SIGN	DATE
DRAWN BY			
CHECKED BY			
REVIEWED & APPROVED BY			
DRAWING NO.			
DESCRIPTION			
APPROVAL			
▲			
▲			
▲			
▲			
▲			
REV			
NOTES			
PAGE		TOTAL	
INSTITUTION			
Departement of Architecture UNIVERSITAS ISLAM INDONESIA			

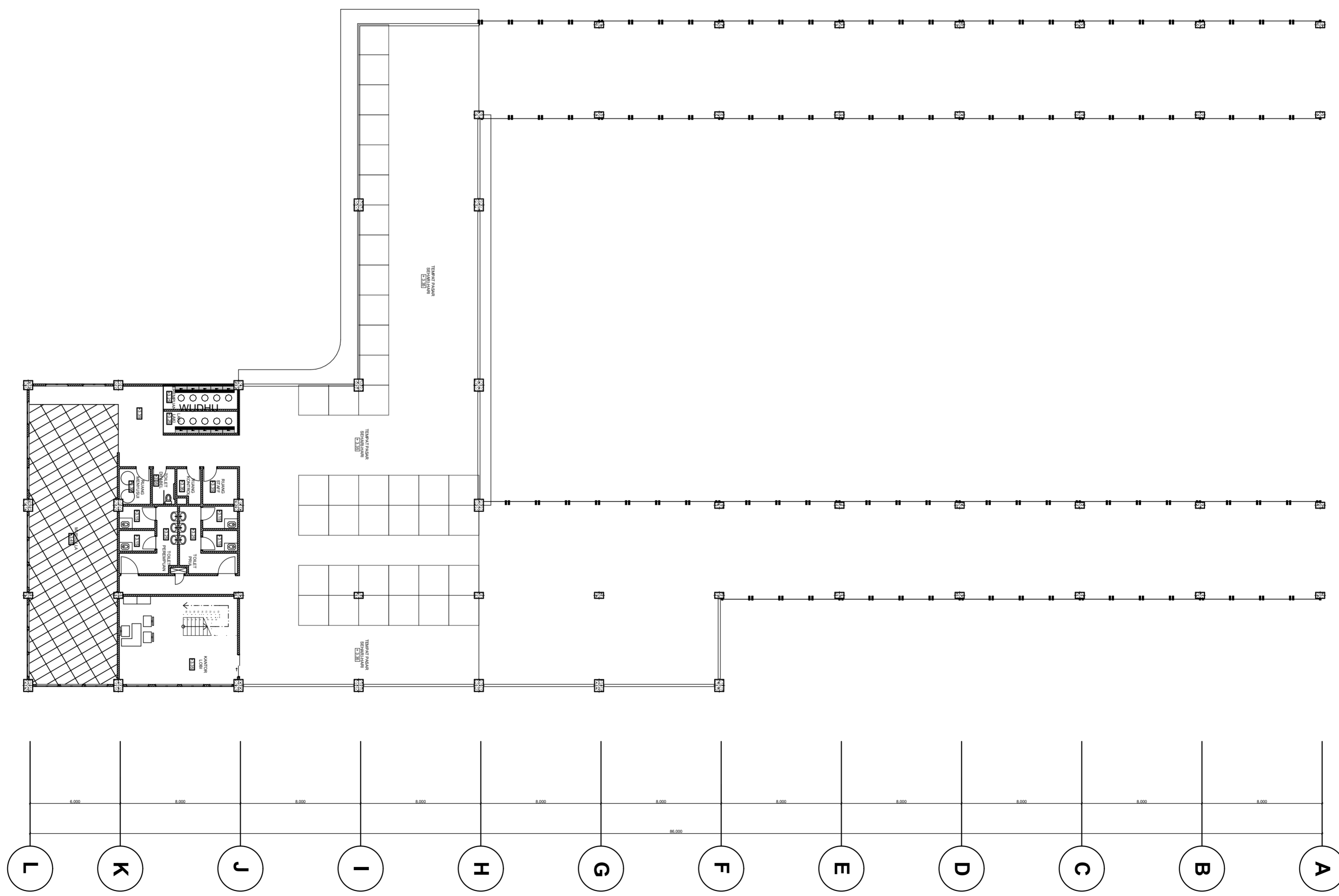

PLANNING CONSULTANT	
PROJECT	
RE-DESIGN PASAR LEMPUYANGAN YOGYAKARTA	
OWNER	
PT. LEMPUYANGAN	
CHIEF ARCHITECT	ID
HAFIAN AKBAR	14512202
TEAM NAME	ID
IN HOUSE ARCHITECT	
CLIENT	
Syarifah Ismailiyah A., ST., MT., IAI	
DRAWING TITLE	
LT SATU	
DRAWING BY HAFIAN AKBAR	
STATUS	
SCALE	FILE NO.
1:200	A-04
	NAME SIGN DATE
DRAWN BY	
CHECKED BY	
REVIEWED & APPROVED BY	
DRAWING NO.	
DESCRIPTION	
APPROVAL	
△	
△	
△	
△	
REV	
NOTES	
PAGE	TOTAL
INSTITUTION	
Departement of Architecture UNIVERSITAS ISLAM INDONESIA	
	

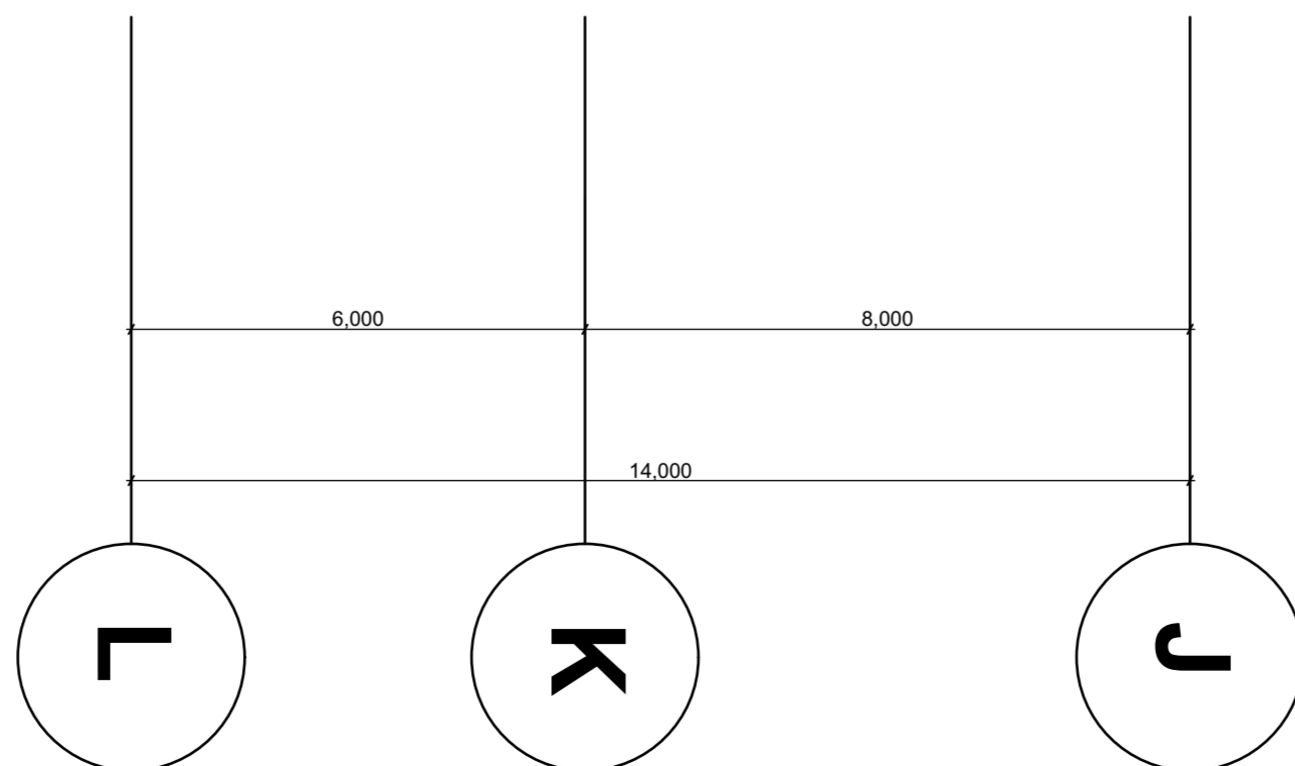
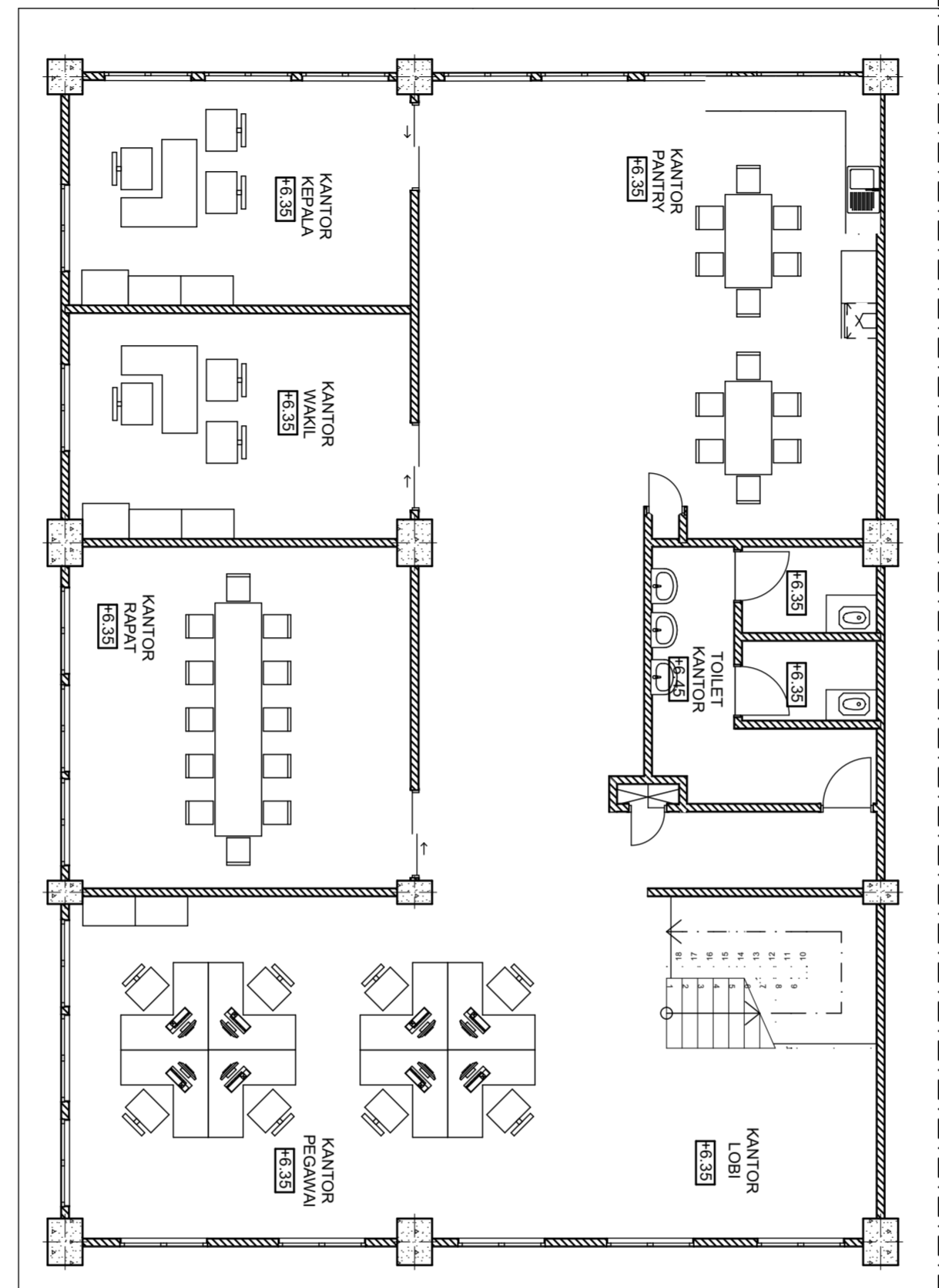
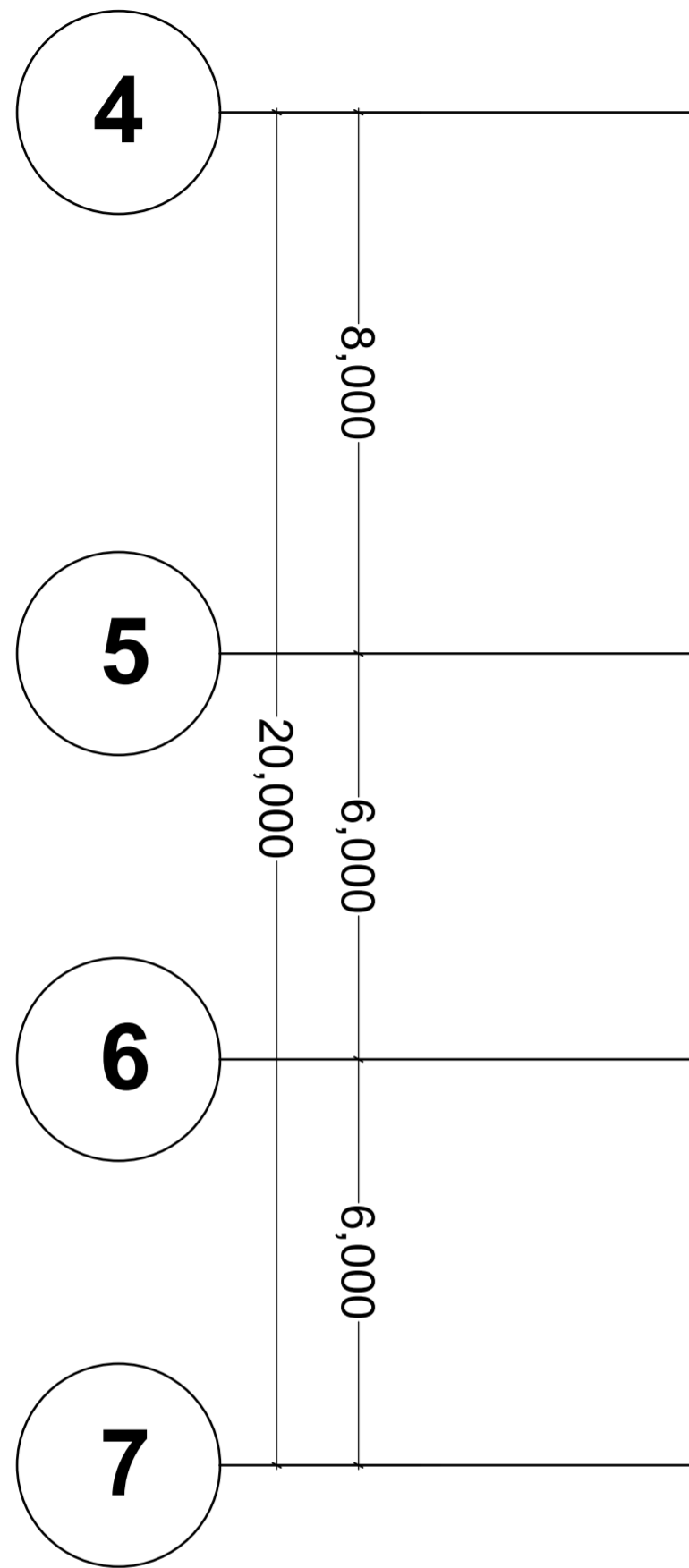

PLANNING CONSULTANT

PROJECT

RE-DESIGN PASAR LEMPUYANGAN  
YOGYAKARTA

OWNER

PT. LEMPUYANGAN

CHIEF ARCHITECT ID

HAFIAN AKBAR 14512202

TEAM NAME ID

IN HOUSE ARCHITECT

CLIENT

Syarifah Ismailiyah A., ST., MT., IAI

DRAWING TITLE

LT DUA

DRAWING BY HAFIAN AKBAR

STATUS

SCALE 1:100 FILE NO. A-05

APPROVAL

△

△

△

△

△

REV

NOTES

PAGE TOTAL

INSTITUTION  
Departement of Architecture  
UNIVERSITAS ISLAM INDONESIA



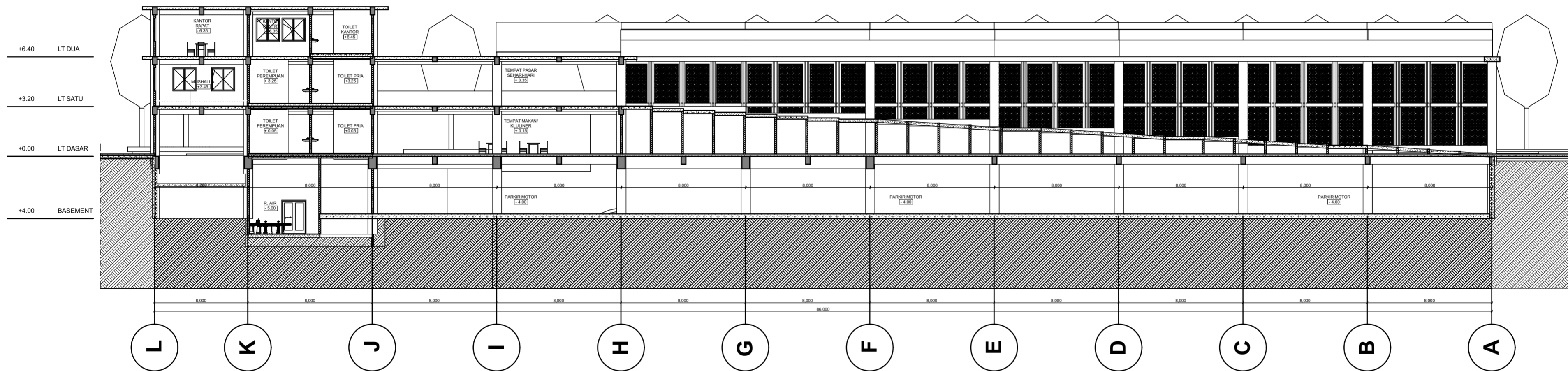

PLANNING  
CONSULTANT

PROJECT  
RE-DESIGN PASAR LEMPUYANGAN  
YOGYAKARTA

OWNER  
PT. LEMPUYANGAN

CHIEF ARCHITECT ID

HAFIAN AKBAR 14512202

TEAM NAME ID

IN HOUSE ARCHITECT

CLIENT  
Syarifah Ismailiyah A., ST., MT., IAI

DRAWING TITLE  
POTONGAN AA'

DRAWING BY HAFIAN AKBAR

STATUS

SCALE 1:200 FILE NO. A-06

NAME SIGN DATE

DRAWN BY

CHECKED BY

REVIEWED & APPROVED BY

DRAWING NO.

DESCRIPTION

APPROVAL

△		
△		
△		
△		
△		
REV		

NOTES

PAGE TOTAL

INSTITUTION  
Departement of Architecture  
UNIVERSITAS ISLAM INDONESIA



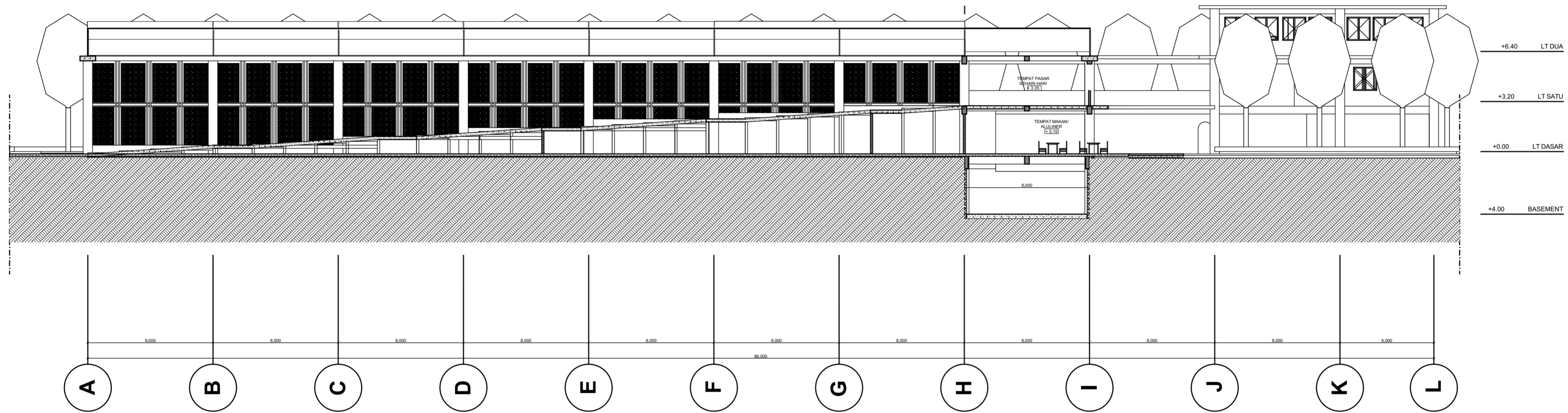

PLANNING  
CONSULTANT

PROJECT

RE-DESIGN PASAR LEMPUYANGAN  
YOGYAKARTA

OWNER

PT. LEMPUYANGAN

CHIEF ARCHITECT ID

HAFIAN AKBAR 14512202

TEAM NAME ID

IN HOUSE ARCHITECT

CLIENT

Syarifah Ismailiyah A., ST., MT., IAI

DRAWING TITLE

POTONGAN BB'

DRAWING BY HAFIAN AKBAR

STATUS

SCALE 1:200 FILE NO. A-07

NAME SIGN DATE

DRAWN BY

CHECKED BY

REVIEWED & APPROVED BY

DRAWING NO.

DESCRIPTION

APPROVAL

△			
△			
△			
△			
△			
REV			

NOTES

PAGE TOTAL

INSTITUTION  
Departement of Architecture  
UNIVERSITAS ISLAM INDONESIA





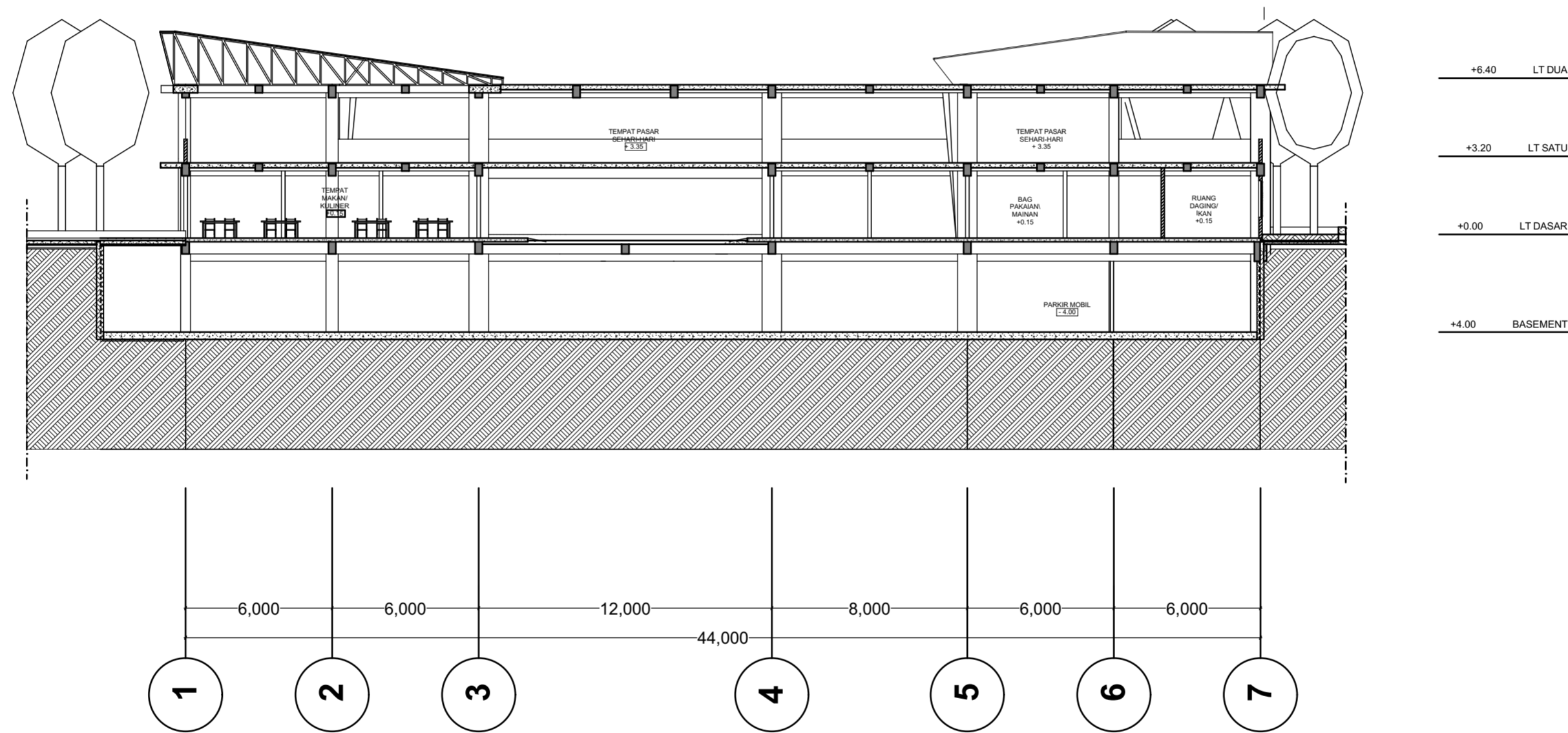

PLANNING CONSULTANT

PROJECT

RE-DESIGN PASAR LEMPUYANGAN  
YOGYAKARTA

OWNER

PT. LEMPUYANGAN

CHIEF ARCHITECT ID

HAFIAN AKBAR 14512202

TEAM NAME ID

IN HOUSE ARCHITECT

CLIENT

Syarifah Ismailiyah A., ST., MT., IAI

DRAWING TITLE

POTONGAN CC'

DRAWING BY HAFIAN AKBAR

STATUS

SCALE 1:200 FILE NO. A-08

NAME	SIGN	DATE

DRAWN BY

CHECKED BY

REVIEWED & APPROVED BY

DRAWING NO.

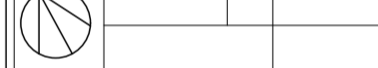

DESCRIPTION

APPROVAL

△			
△			
△			
△			
△			
REV			

NOTES

PAGE	TOTAL

INSTITUTION  
Departement of Architecture  
UNIVERSITAS ISLAM INDONESIA



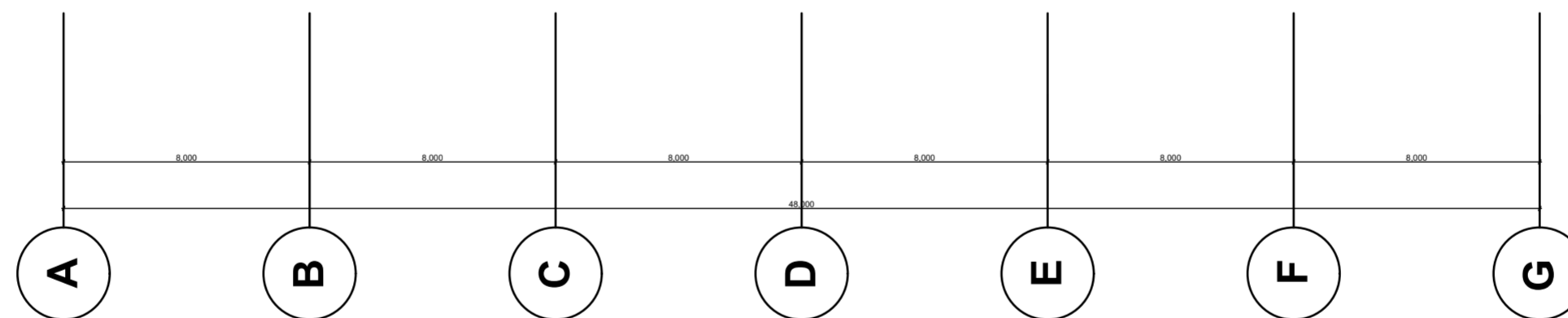
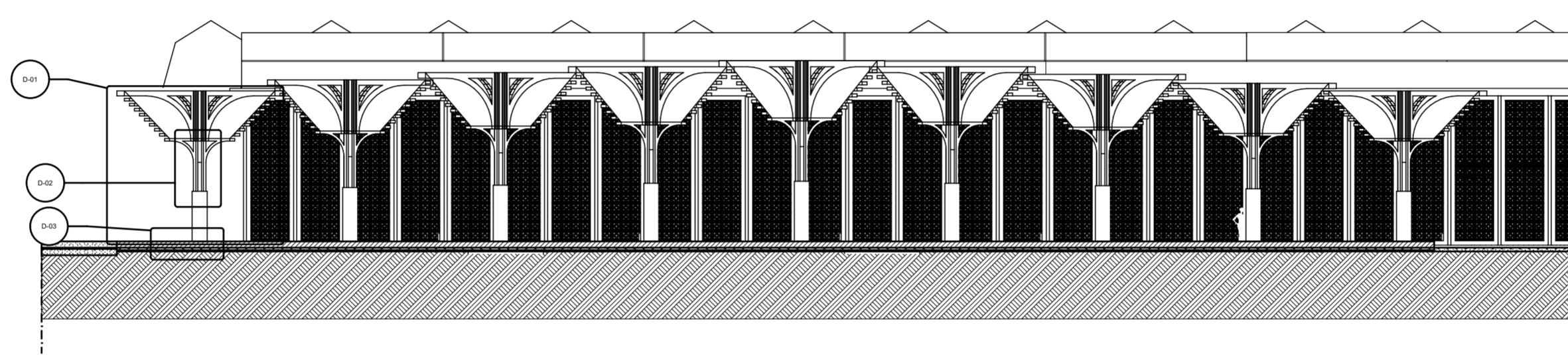

PLANNING  
CONSULTANT

PROJECT

RE-DESIGN PASAR LEMPUYANGAN  
YOGYAKARTA

OWNER

PT. LEMPUYANGAN

CHIEF ARCHITECT

ID

HAFIAN AKBAR

14512202

TEAM NAME

ID

IN HOUSE ARCHITECT

CLIENT

Syarifah Ismailiyah A., ST., MT., IAI

DRAWING TITLE

POTONGAN DD'

DRAWING BY

HAFIAN AKBAR

STATUS

SCALE 1:200

FILE NO. A-09

NAME SIGN DATE

DRAWN BY

CHECKED BY

REVIEWED & APPROVED BY

DRAWING NO.



DESCRIPTION

APPROVAL

△			
△			
△			
△			
△			
△			
REV			

NOTES

PAGE

TOTAL

INSTITUTION  
Departement of Architecture  
UNIVERSITAS ISLAM INDONESIA



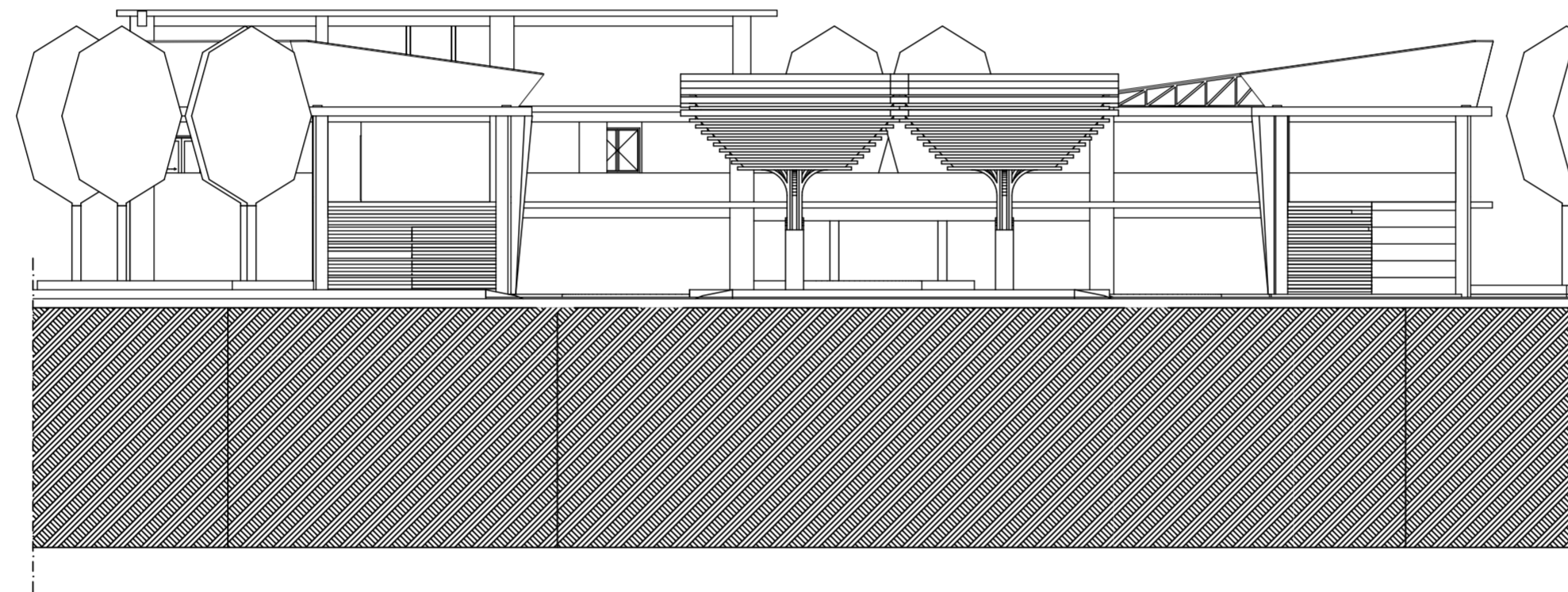

PLANNING  
CONSULTANT

PROJECT

RE-DESIGN PASAR LEMPUYANGAN  
YOGYAKARTA

OWNER

PT. LEMPUYANGAN

CHIEF ARCHITECT

ID

HAFIAN AKBAR

14512202

TEAM NAME

ID

IN HOUSE ARCHITECT

CLIENT

Syarifah Ismailiyah A., ST., MT., IAI

DRAWING TITLE

TAMPAK DEPAN

DRAWING BY

HAFIAN AKBAR

STATUS

SCALE 1:200

FILE NO. A-10

DRAWN BY

NAME

SIGN

DATE

CHECKED BY

REVIEWED & APPROVED BY

DRAWING NO.



DESCRIPTION

APPROVAL

△			
△			
△			
△			
△			
△			

NOTES

PAGE

TOTAL

INSTITUTION  
Departement of Architecture  
UNIVERSITAS ISLAM INDONESIA



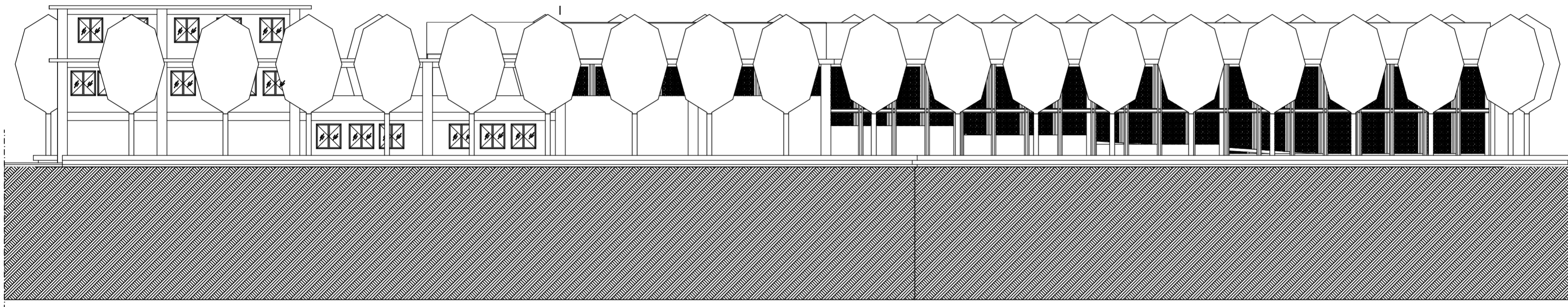

PLANNING  
CONSULTANT

PROJECT

RE-DESIGN PASAR LEMPUYANGAN  
YOGYAKARTA

OWNER

PT. LEMPUYANGAN

CHIEF ARCHITECT ID

HAFIAN AKBAR 14512202

TEAM NAME ID

IN HOUSE ARCHITECT

CLIENT

Syarifah Ismailiyah A., ST., MT., IAI

DRAWING TITLE

TAMPAK KANAN

DRAWING BY HAFIAN AKBAR

STATUS

SCALE 1:200 FILE NO. A-11

NAME	SIGN	DATE

DRAWN BY

CHECKED BY

REVIEWED & APPROVED BY

DRAWING NO.



DESCRIPTION

APPROVAL

△			
△			
△			
△			
△			
REV			

NOTES

PAGE	TOTAL

INSTITUTION  
Departement of Architecture  
UNIVERSITAS ISLAM INDONESIA



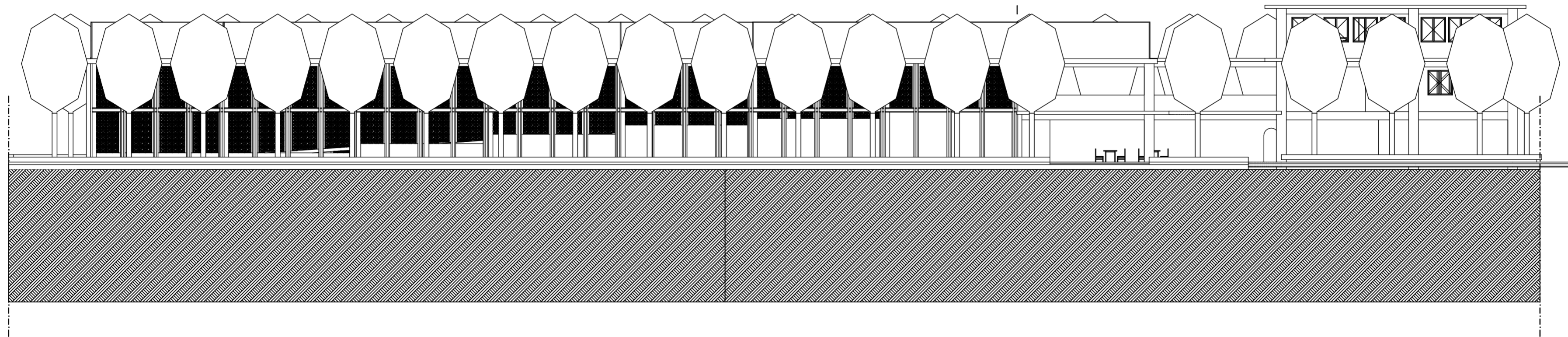

PLANNING  
CONSULTANT

PROJECT

RE-DESIGN PASAR LEMPUYANGAN  
YOGYAKARTA

OWNER

PT. LEMPUYANGAN

CHIEF ARCHITECT ID

HAFIAN AKBAR 14512202

TEAM NAME ID

IN HOUSE ARCHITECT

CLIENT

Syarifah Ismailiyah A., ST., MT., IAI

DRAWING TITLE

TAMPAK KIRI

DRAWING BY HAFIAN AKBAR

STATUS

SCALE 1:200 FILE NO. A-12

NAME	SIGN	DATE

DRAWN BY

CHECKED BY

REVIEWED & APPROVED BY

DRAWING NO.

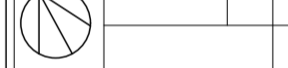

DESCRIPTION

APPROVAL

△			
△			
△			
△			
△			
REV			

NOTES

PAGE	TOTAL

INSTITUTION  
Departement of Architecture  
UNIVERSITAS ISLAM INDONESIA



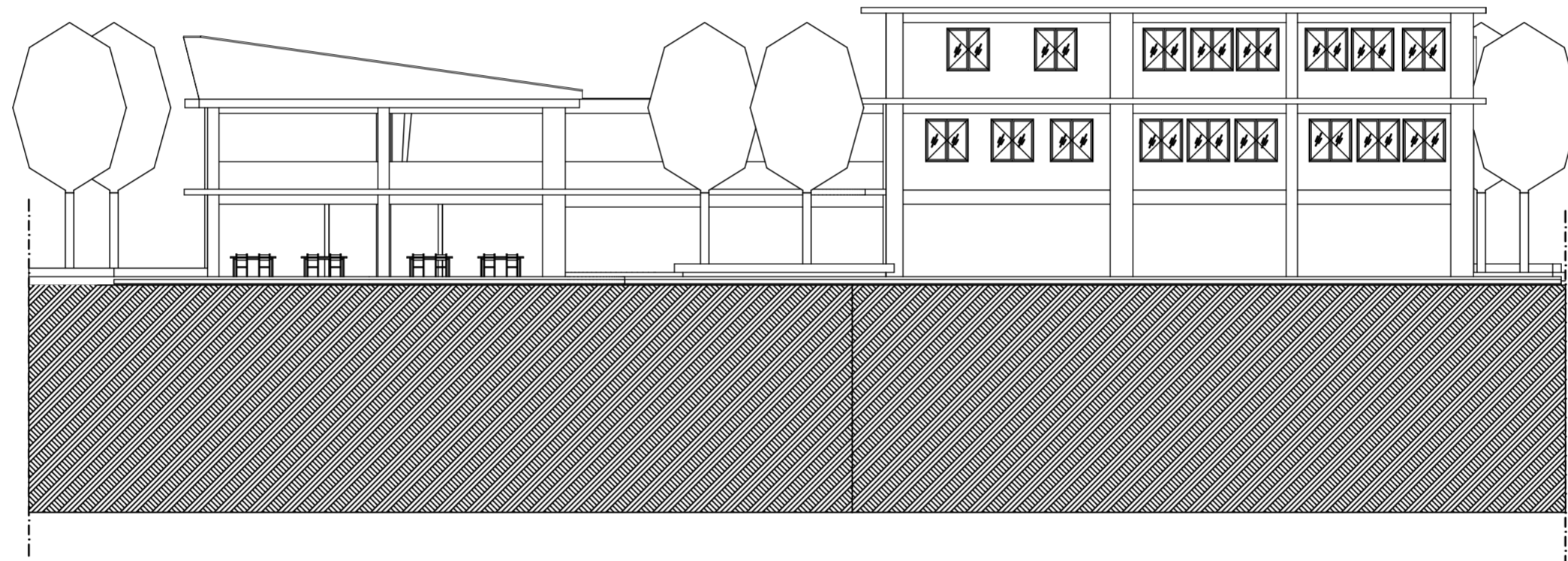

PLANNING  
CONSULTANT

PROJECT

RE-DESIGN PASAR LEMPUYANGAN  
YOGYAKARTA

OWNER

PT. LEMPUYANGAN

CHIEF ARCHITECT ID

HAFIAN AKBAR 14512202

TEAM NAME ID

IN HOUSE ARCHITECT

CLIENT

Syarifah Ismailiyah A., ST., MT., IAI

DRAWING TITLE

TAMPAK  
BELAKANG

DRAWING BY HAFIAN AKBAR

STATUS

SCALE 1:200 FILE NO. A-13

NAME	SIGN	DATE

DRAWN BY

CHECKED BY

REVIEWED & APPROVED BY

DRAWING NO.

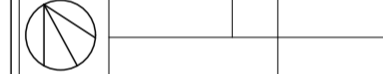

DESCRIPTION

APPROVAL

△			
△			
△			
△			
△			
△			
REV			

NOTES

PAGE	TOTAL

INSTITUTION  
Departement of Architecture  
UNIVERSITAS ISLAM INDONESIA



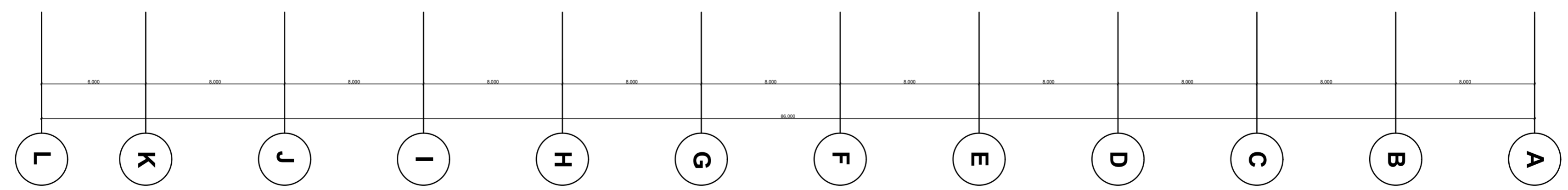
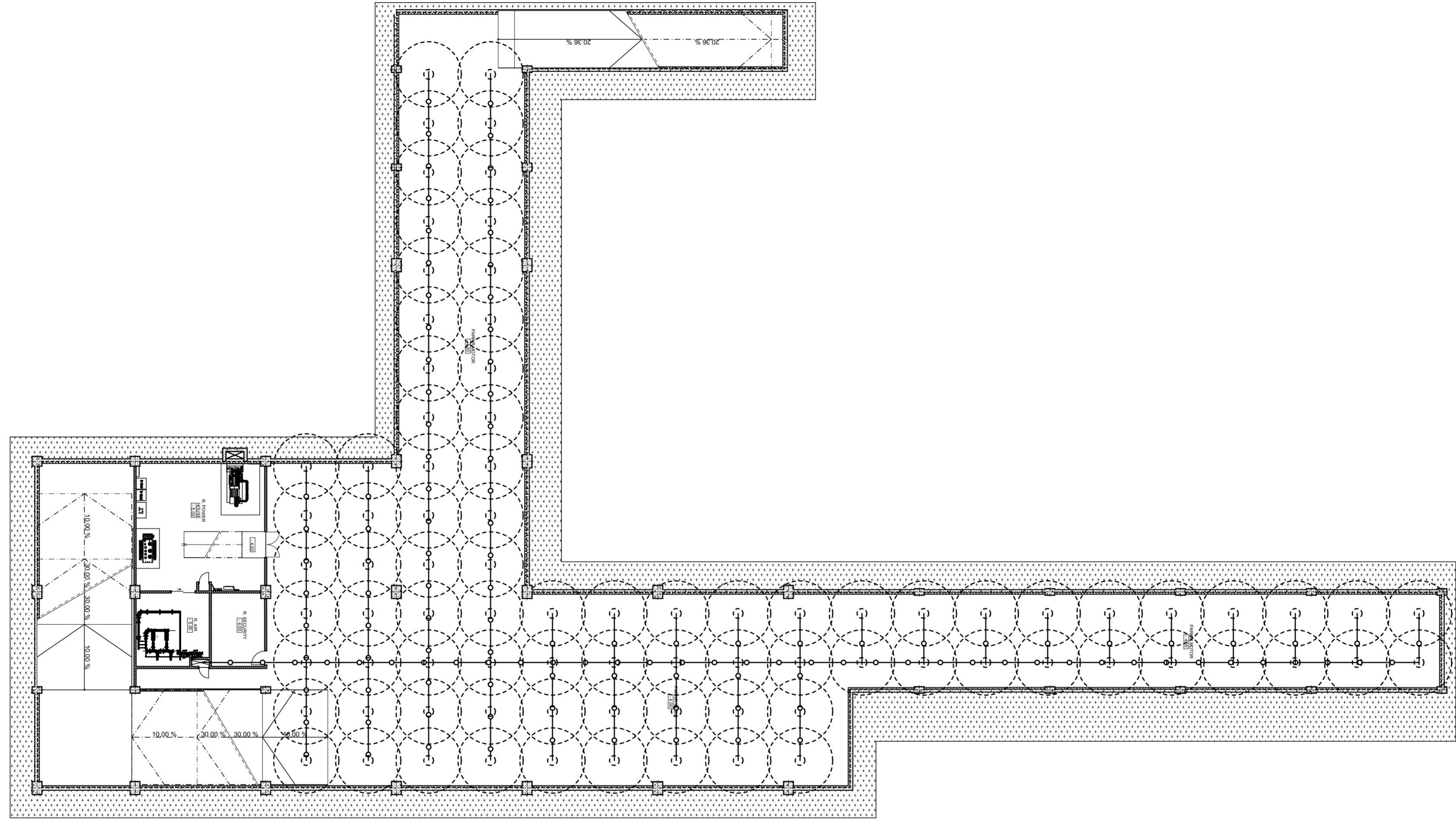
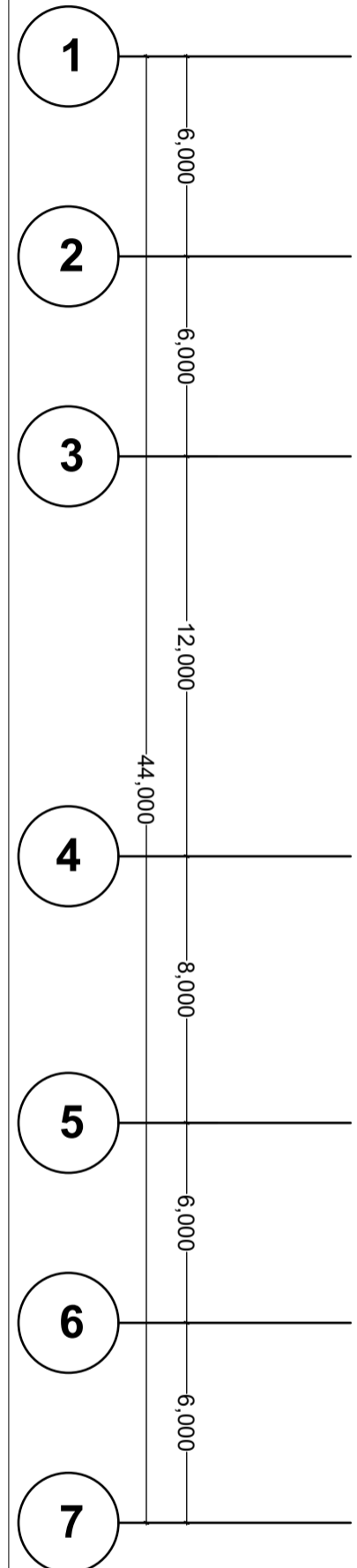

PLANNING CONSULTANT		
PROJECT		
RE-DESIGN PASAR LEMPUYANGAN YOGYAKARTA		
OWNER		
PT. LEMPUYANGAN		
CHIEF ARCHITECT	ID	
HAFIAN AKBAR	14512202	
TEAM NAME	ID	
IN HOUSE ARCHITECT		
CLIENT		
Syarifah Ismailiyah A., ST., MT., IAI		
DRAWING TITLE		
RENCANA AIR BASEMENT		
DRAWN BY HAFIAN AKBAR		
STATUS		
SCALE	1:200	FILE NO. ME-01
	NAME	SIGN DATE
DRAWN BY		
CHECKED BY		
REVIEWED & APPROVED BY		
DRAWING NO.		
DESCRIPTION		
APPROVAL		
△		
△		
△		
△		
△		
REV		
NOTES		
PAGE	TOTAL	
INSTITUTION		
Departement of Architecture UNIVERSITAS ISLAM INDONESIA		

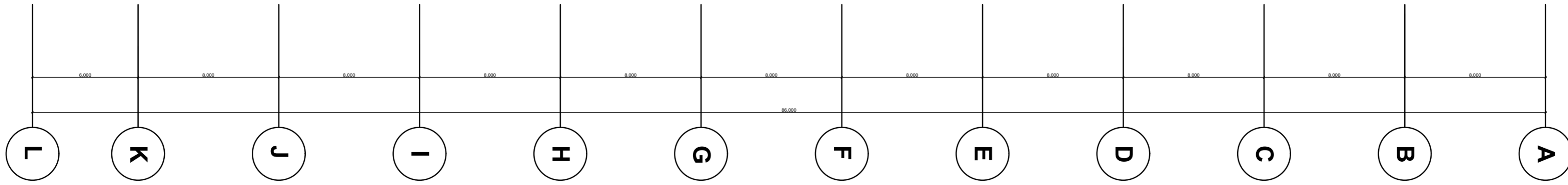
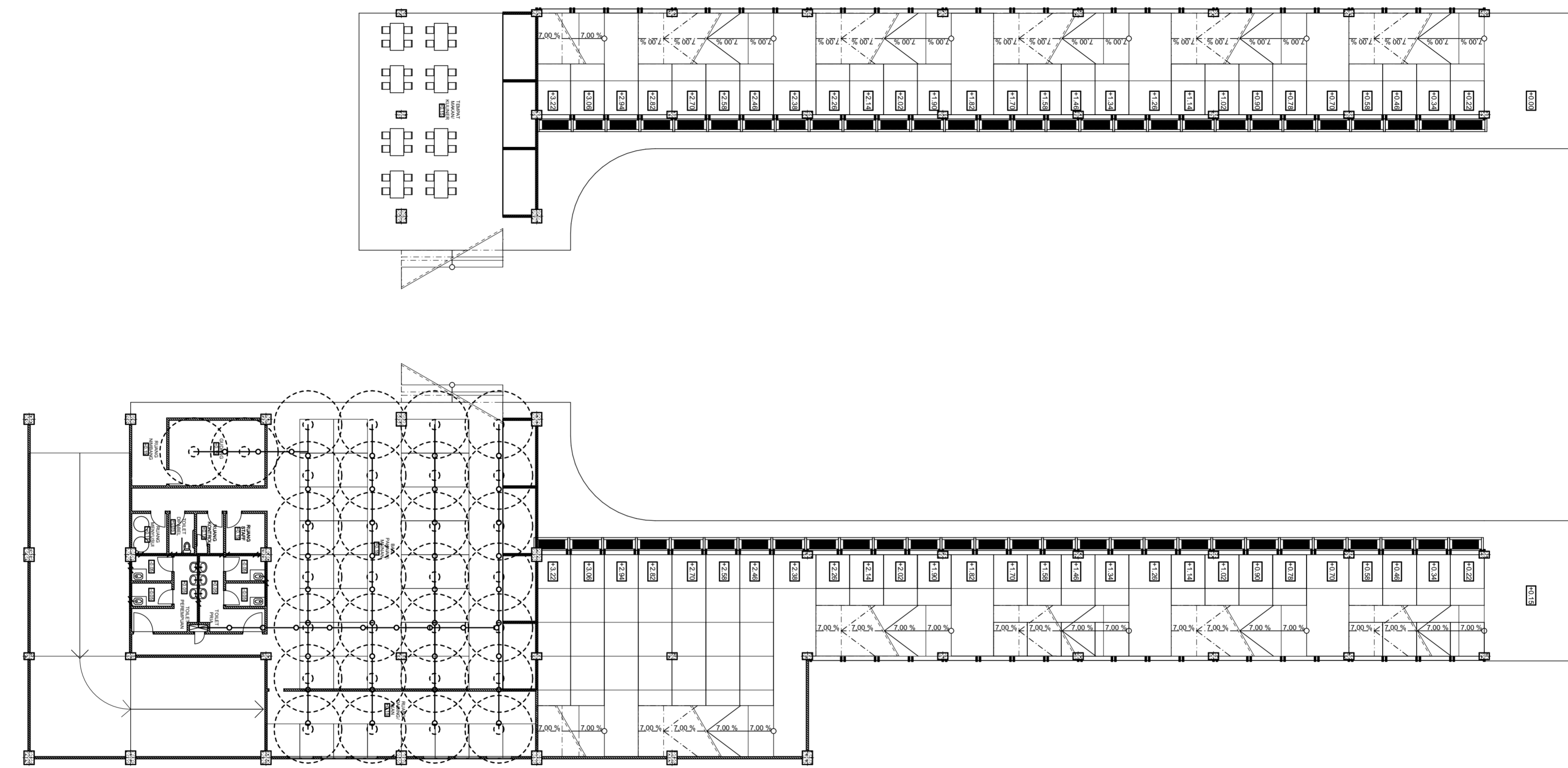
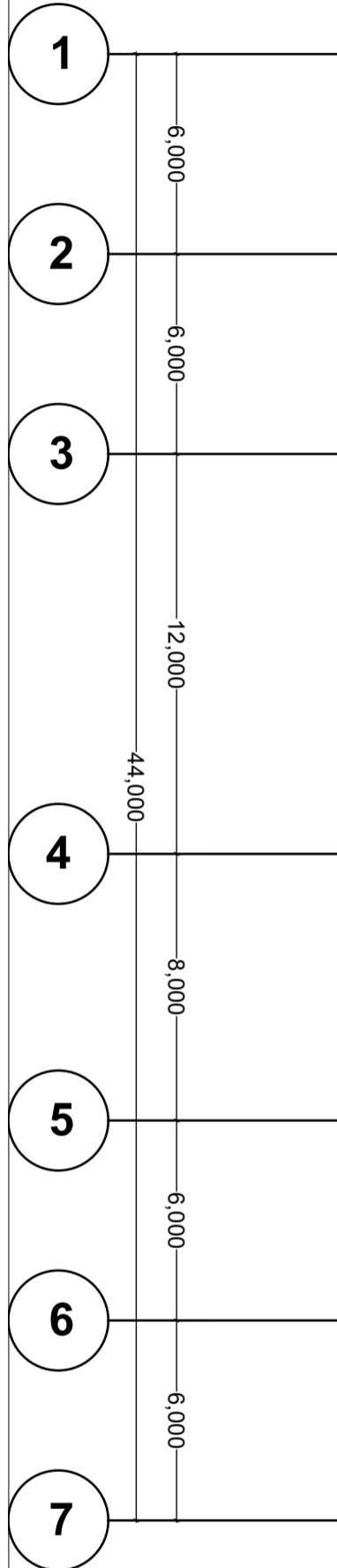

**PLANNING CONSULTANT**

---

**PROJECT**  
 RE-DESIGN PASAR LEMPUYANGAN  
 YOGYAKARTA

**OWNER**  
 PT. LEMPUYANGAN

**CHIEF ARCHITECT** ID  
 HAFIAN AKBAR 14512202

**TEAM NAME** ID

---

**IN HOUSE ARCHITECT**

---

**CLIENT**  
 Syarifah Ismailiyah A., ST., MT., IAI

**DRAWING TITLE**  
 RENCANA AIR LT  
 DASAR

**DRAWING BY** HAFIAN AKBAR

---

**STATUS**

**SCALE** 1:200 **FILE NO.** ME-02

NAME	SIGN	DATE

**DRAWN BY**  
**CHECKED BY**  
**REVIEWED & APPROVED BY**  
**DRAWING NO.**

---

**DESCRIPTION**

- SPRINKLE
- PIPA SPRINKLE
- PIPA AIR

---

**APPROVAL**



**NOTES**

PAGE	TOTAL

---

**INSTITUTION**  
 Departemen of Architecture  
 UNIVERSITAS ISLAM INDONESIA

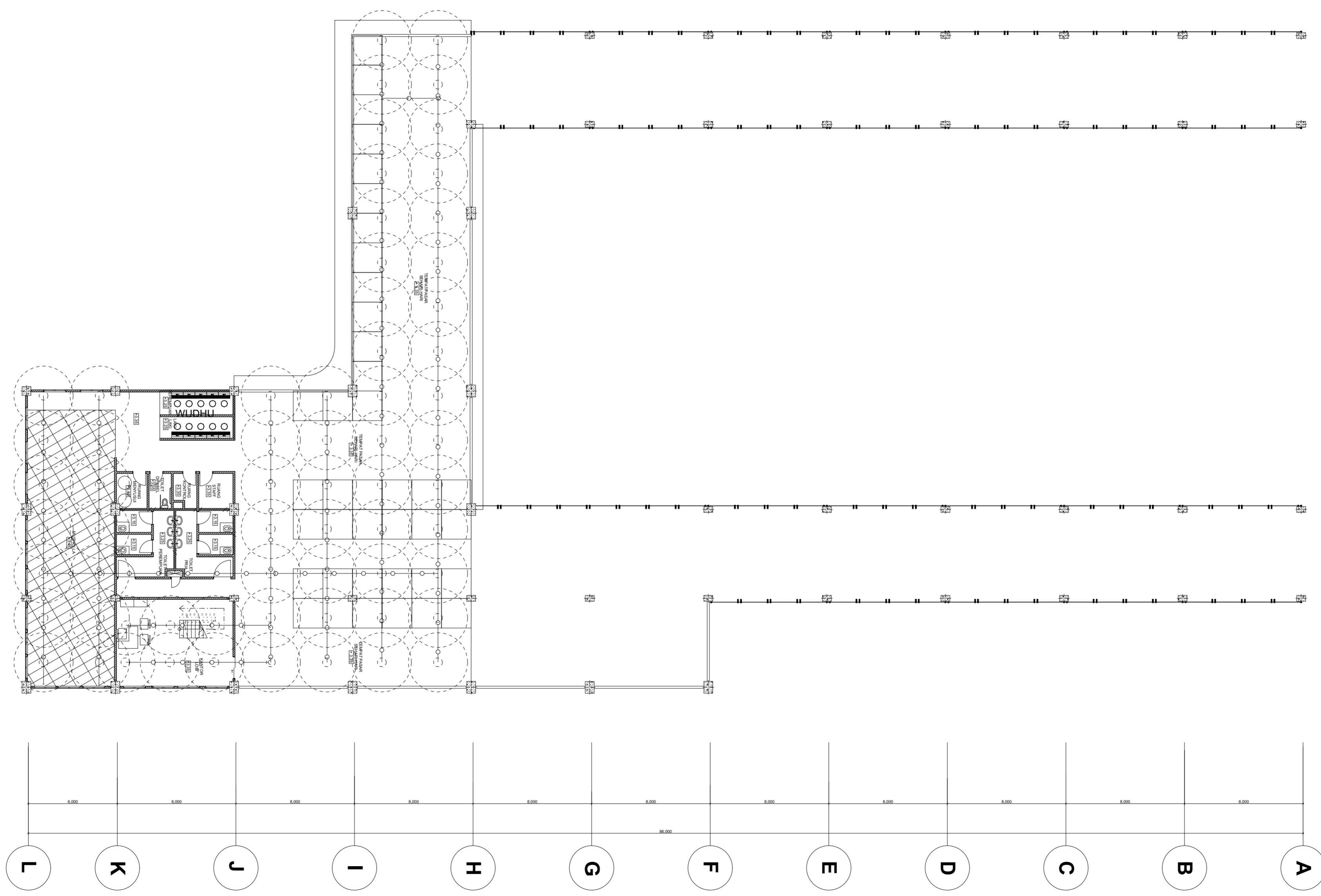



PLANNING CONSULTANT																	
PROJECT																	
RE-DESIGN PASAR LEMPUYANGAN YOGYAKARTA																	
OWNER																	
PT. LEMPUYANGAN																	
CHIEF ARCHITECT	ID																
HAFIAN AKBAR	14512202																
TEAM NAME	ID																
IN HOUSE ARCHITECT																	
CLIENT																	
Syarifah Ismailiyah A., ST., MT., IAI																	
DRAWING TITLE																	
RENCANA AIR LT																	
DRAWING BY HAFIAN AKBAR																	
STATUS																	
SCALE	1:200	FILE NO. ME-03															
	NAME	SIGN															
DRAWN BY																	
CHECKED BY																	
REVIEWED & APPROVED BY																	
DRAWING NO.																	
DESCRIPTION																	
APPROVAL																	
<table border="1"> <tr><td>▲</td><td></td><td></td></tr> <tr><td>▲</td><td></td><td></td></tr> <tr><td>▲</td><td></td><td></td></tr> <tr><td>▲</td><td></td><td></td></tr> <tr><td>REV</td><td></td><td></td></tr> </table>			▲			▲			▲			▲			REV		
▲																	
▲																	
▲																	
▲																	
REV																	
NOTES																	
PAGE	TOTAL																
INSTITUTION																	
Departement of Architecture UNIVERSITAS ISLAM INDONESIA																	

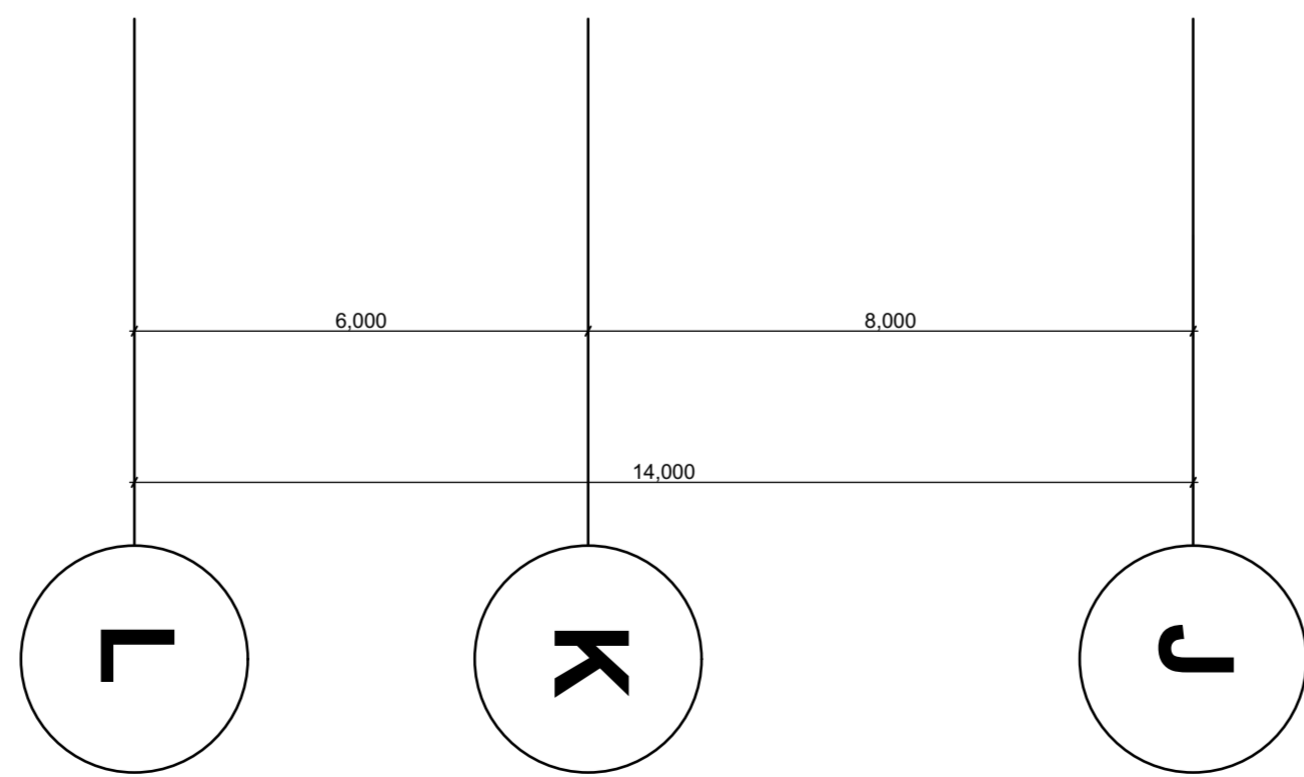
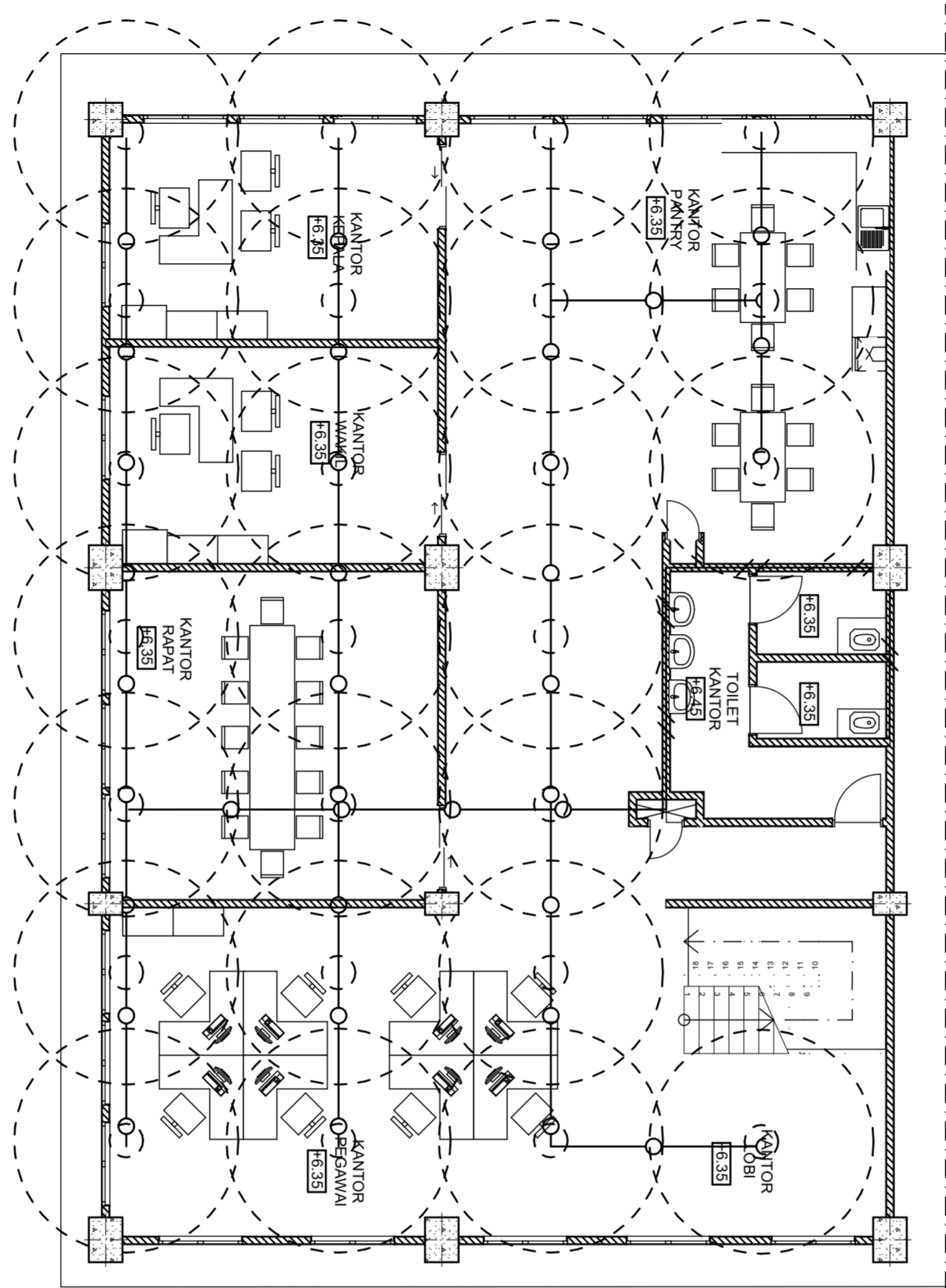
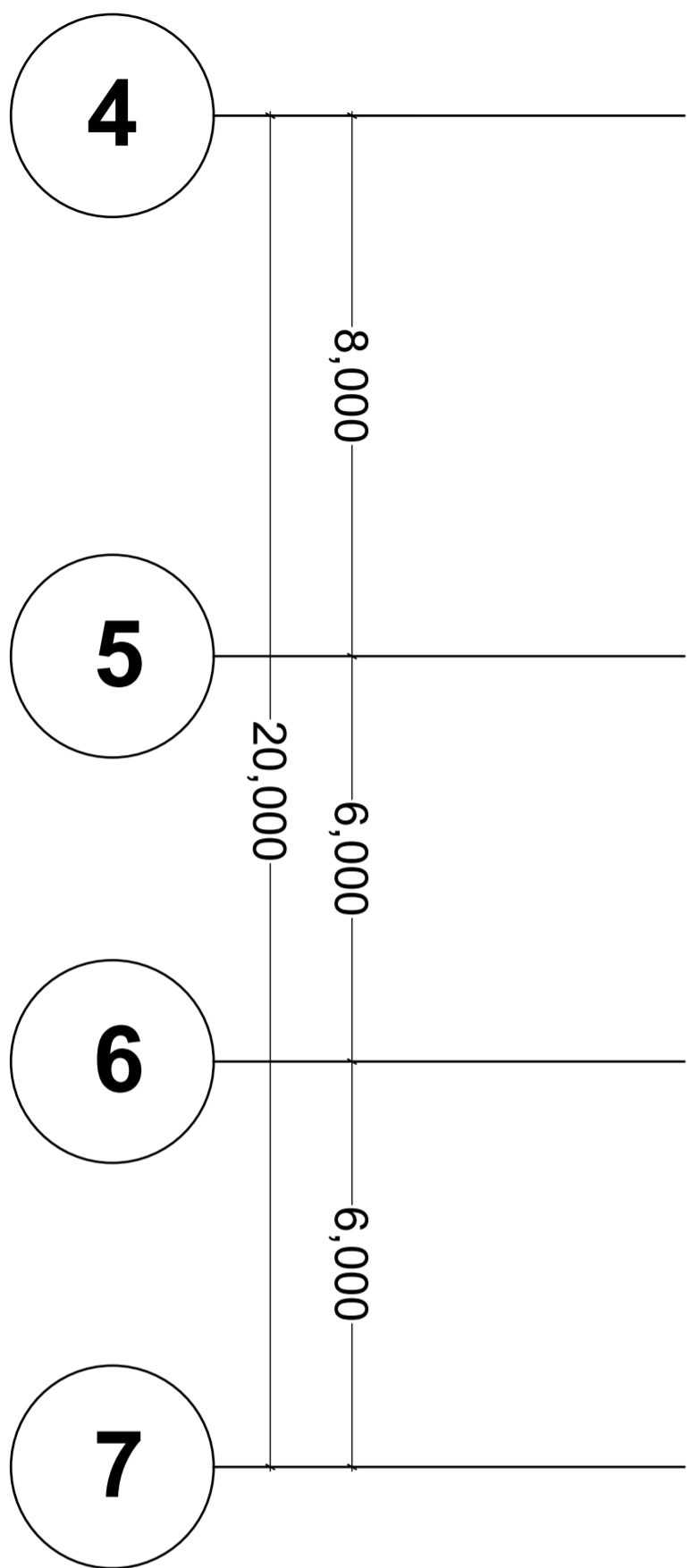

PLANNING CONSULTANT			
PROJECT			
RE-DESIGN PASAR LEMPUYANGAN YOGYAKARTA			
OWNER			
PT. LEMPUYANGAN			
CHIEF ARCHITECT	ID		
HAFIAN AKBAR	14512202		
TEAM NAME	ID		
IN HOUSE ARCHITECT			
CLIENT			
Syarifah Ismailiyah A., ST., MT., IAI			
DRAWING TITLE			
RENCANA AIR LT			
DRAWING BY DUA HAFIAN AKBAR			
STATUS			
SCALE	FILE NO.		
1:100	ME-04		
	NAME SIGN DATE		
DRAWN BY			
CHECKED BY			
REVIEWED & APPROVED BY			
DRAWING NO.			
DESCRIPTION			
APPROVAL			
△			
△			
△			
△			
△			
REV			
NOTES			
PAGE	TOTAL		
INSTITUTION			
Departement of Architecture UNIVERSITAS ISLAM INDONESIA			

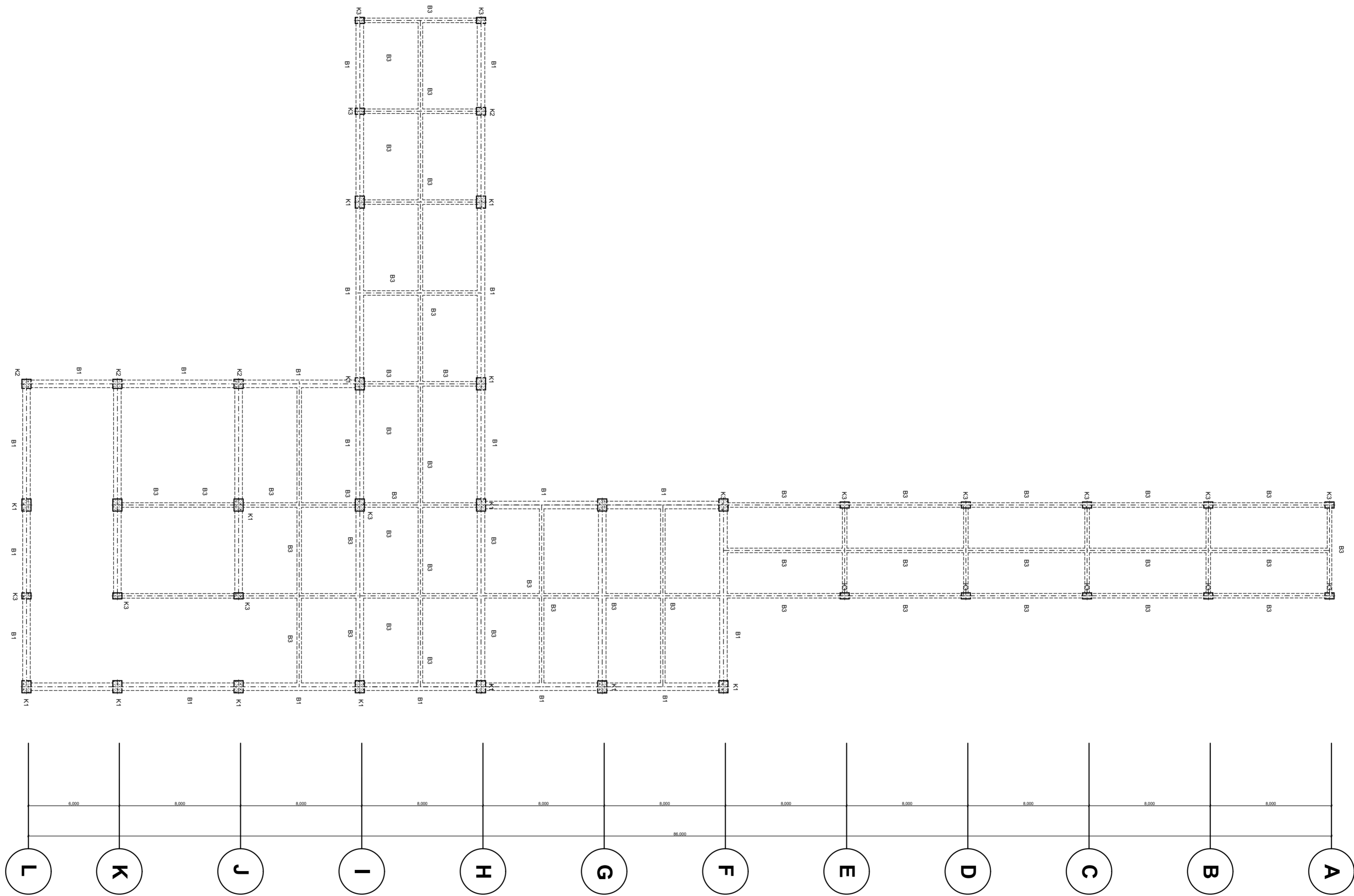
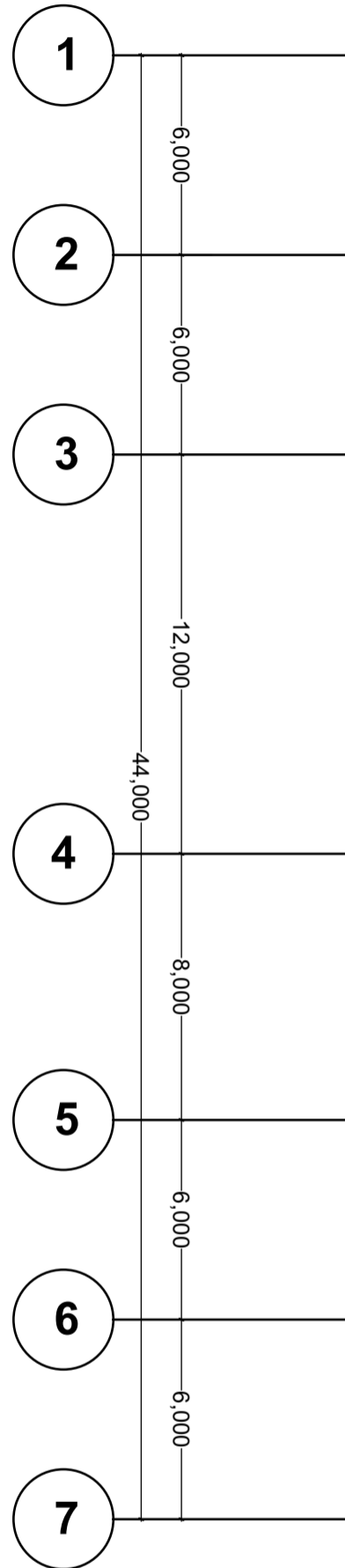

PLANNING CONSULTANT	
PROJECT	
RE-DESIGN PASAR LEMPUYANGAN YOGYAKARTA	
OWNER	
PT. LEMPUYANGAN	
CHIEF ARCHITECT	ID
HAFIAN AKBAR	14512202
TEAM NAME	ID
IN HOUSE ARCHITECT	
CLIENT	
Syarifah Ismailiyah A., ST., MT., IAI	
DRAWING TITLE	
RENCANA KOLOM- BALOK BASEMENT	
STATUS	
SCALE	FILE NO.
1:200	S-01
	NAME
	SIGN
	DATE
DRAWN BY	
CHECKED BY	
REVIEWED & APPROVED BY	
DRAWING NO.	
DESCRIPTION	
<p>KOLOM K1 800X600 K2 600X600 K3 600X400</p> <p>BALOK B2 600X500 B3 500X300 B1 800X500</p>	
APPROVAL	
△	
△	
△	
△	
△	
REV	
NOTES	
PAGE	TOTAL
INSTITUTION	
Departement of Architecture UNIVERSITAS ISLAM INDONESIA	

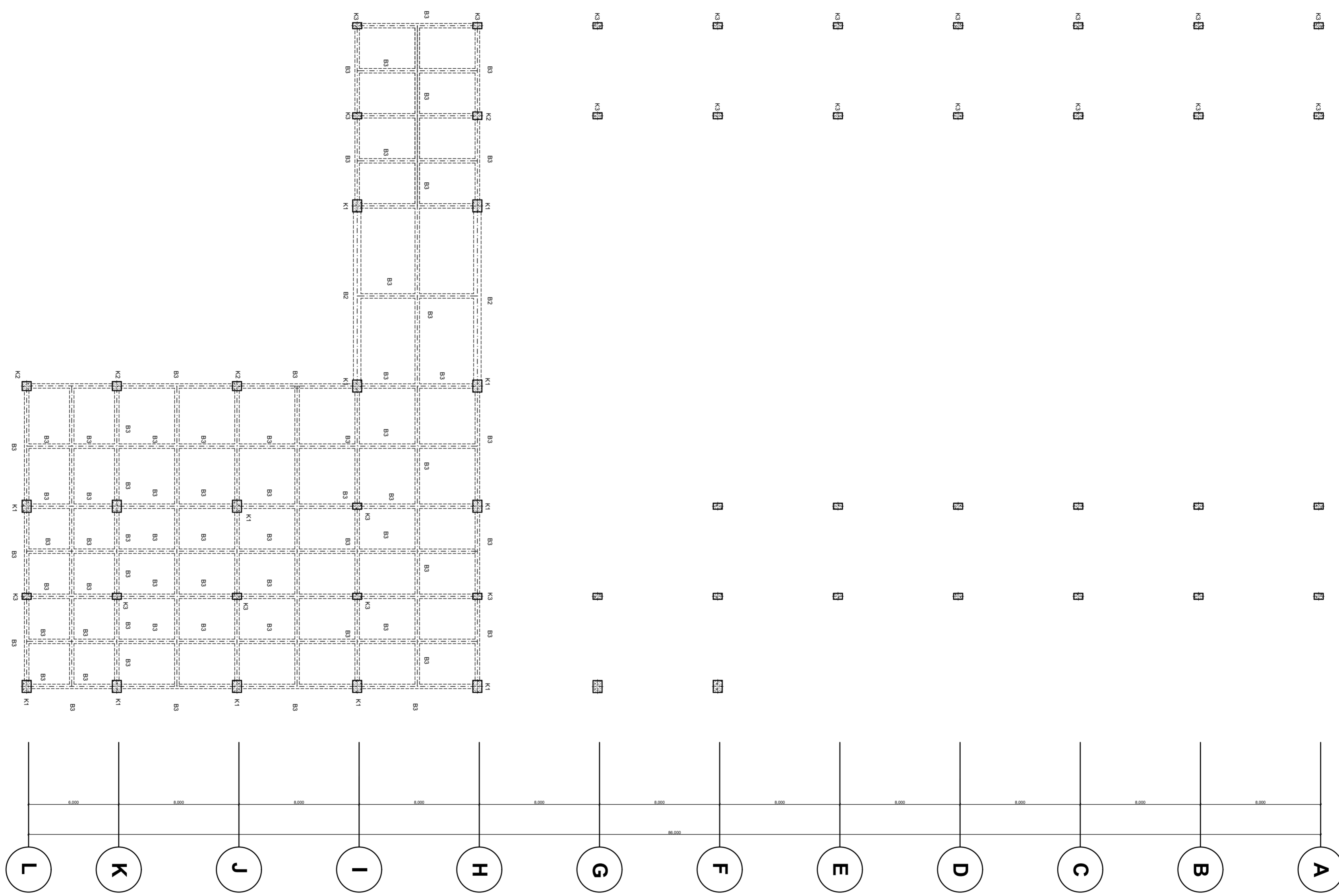
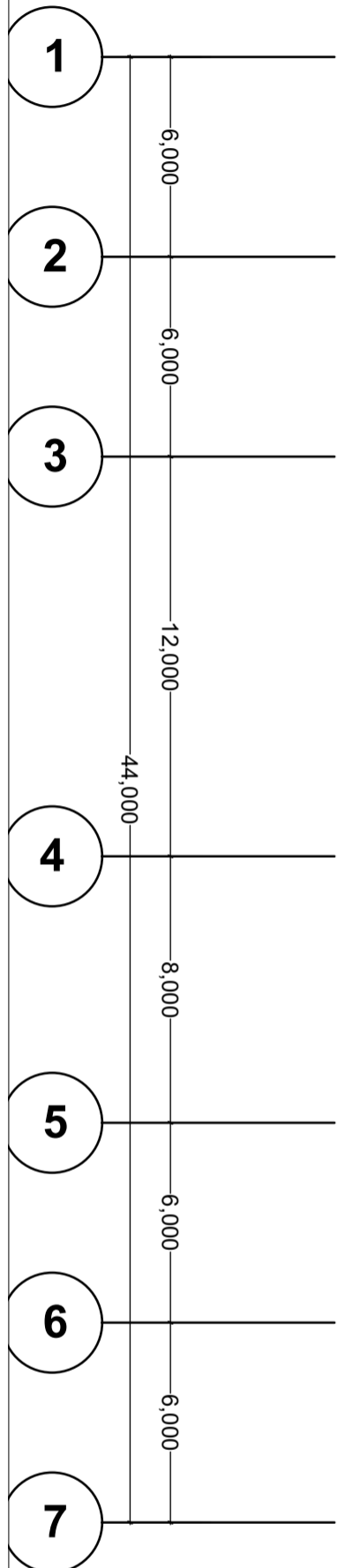

PLANNING CONSULTANT		
PROJECT		
RE-DESIGN PASAR LEMPUYANGAN YOGYAKARTA		
OWNER		
PT. LEMPUYANGAN		
CHIEF ARCHITECT	ID	
HAFIAN AKBAR	14512202	
TEAM NAME	ID	
IN HOUSE ARCHITECT		
CLIENT		
Syarifah Ismailiyah A., ST., MT., IAI		
DRAWING TITLE		
RENCANA KOLOM- BALOK LT.DASAR		
STATUS		
SCALE	1:200	FILE NO. S-02
	NAME	SIGN
DRAWN BY		DATE
CHECKED BY		
REVIEWED & APPROVED BY		
DRAWING NO.		
DESCRIPTION		
KOLOM		
K1 800X600		
K2 600X600		
K3 600X400		
BALOK		
B2 600X500		
B3 500X300		
B1 800X500		
APPROVAL		
△		
△		
△		
△		
△		
REV		
NOTES		
PAGE	TOTAL	
INSTITUTION		
Departement of Architecture UNIVERSITAS ISLAM INDONESIA		

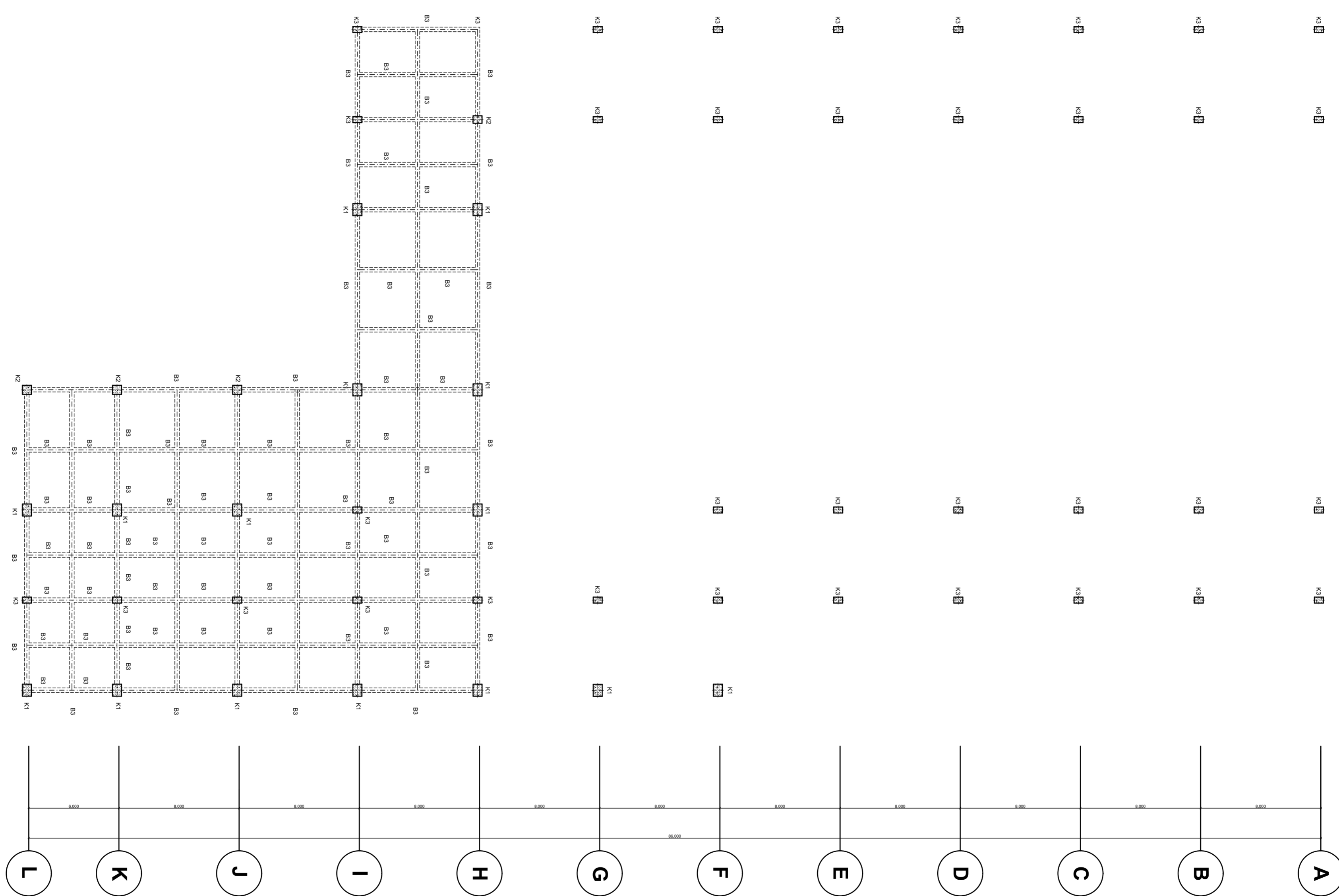

PLANNING CONSULTANT		
PROJECT		
RE-DESIGN PASAR LEMPUYANGAN YOGYAKARTA		
OWNER		
PT. LEMPUYANGAN		
CHIEF ARCHITECT	ID	
HAFIAN AKBAR	14512202	
TEAM NAME	ID	
IN HOUSE ARCHITECT		
CLIENT		
Syarifah Ismailiyah A., ST., MT., IAI		
DRAWING TITLE		
RENCANA KOLOM- BALOK LT. SATU		
DRAWING BY HAFIAN AKBAR		
STATUS		
SCALE	1:200	FILE NO. S-03
	NAME	SIGN DATE
DRAWN BY		
CHECKED BY		
REVIEWED & APPROVED BY		
DRAWING NO.		
DESCRIPTION		
<p>KOLOM</p> <p>K1 800X600</p> <p>K2 600X600</p> <p>K3 600X400</p> <p>BALOK</p> <p>B2 600X500</p> <p>B3 500X300</p> <p>B1 800X500</p>		
APPROVAL		
△		
△		
△		
△		
△		
REV		
NOTES		
PAGE	TOTAL	
INSTITUTION		
Departement of Architecture UNIVERSITAS ISLAM INDONESIA		

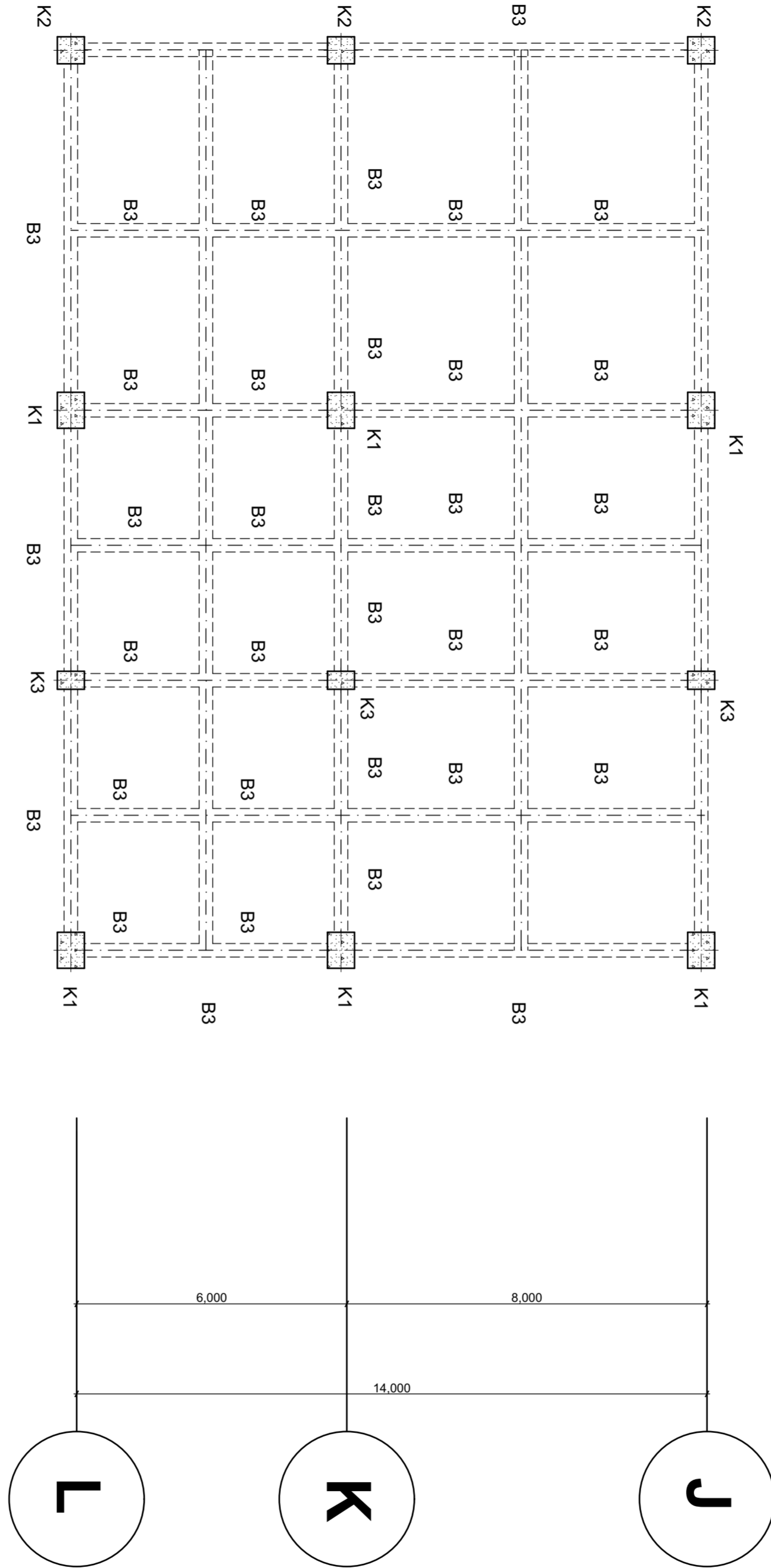
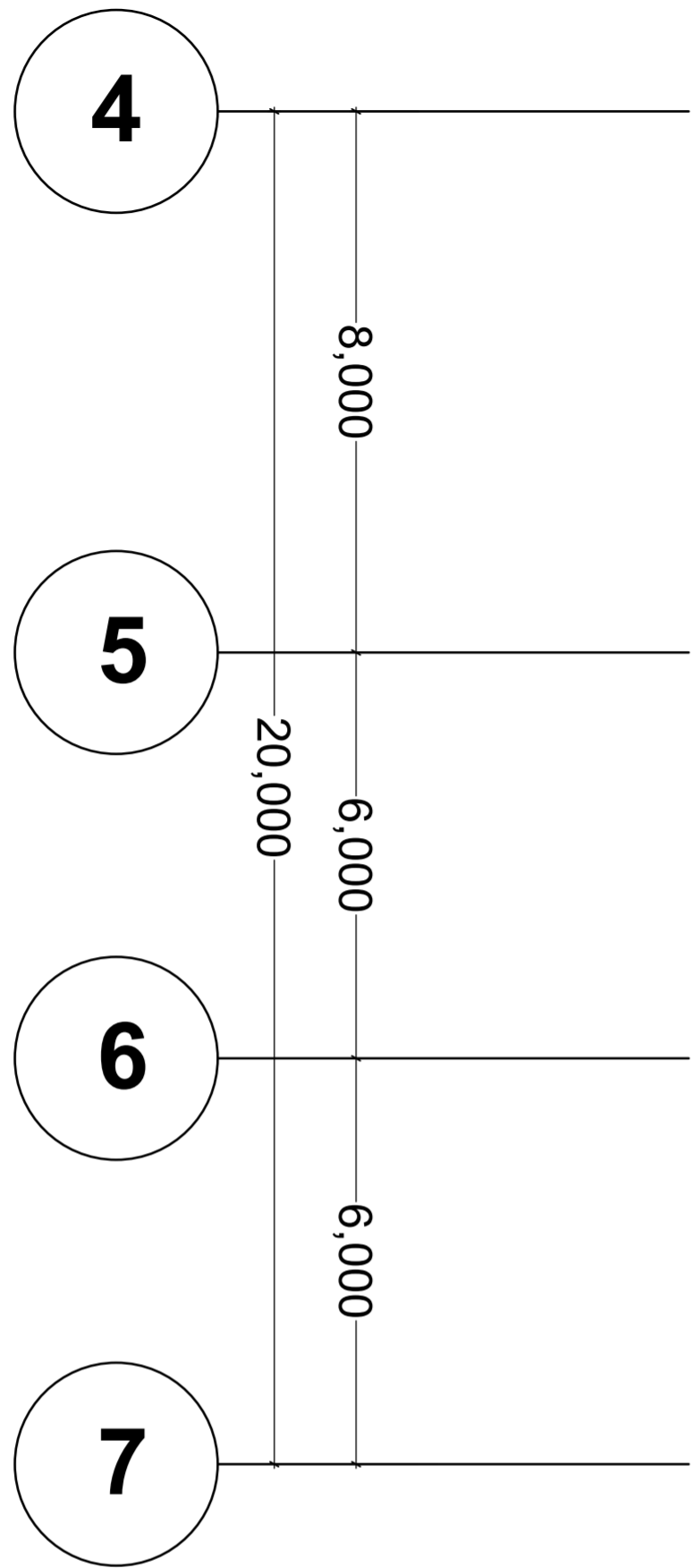

PLANNING CONSULTANT		
PROJECT		
RE-DESIGN PASAR LEMPUYANGAN YOGYAKARTA		
OWNER		
PT. LEMPUYANGAN		
CHIEF ARCHITECT	ID	
HAFIAN AKBAR	14512202	
TEAM NAME	ID	
IN HOUSE ARCHITECT		
CLIENT		
Syarifah Ismailiyah A., ST., MT., IAI		
DRAWING TITLE		
RENCANA KOLOM-BALOK L1, DUA		
DRAWING BY HAFIAN AKBAR		
STATUS		
SCALE	FILE NO.	
1:100	S-04	
NAME	SIGN	DATE
DRAWN BY		
CHECKED BY		
REVIEWED & APPROVED BY		
DRAWING NO.		
DESCRIPTION		
KOLOM		
K1 800X600		
K2 600X600		
K3 600X400		
BALOK		
B2 600X500		
B3 500X300		
B1 800X500		
APPROVAL		
△		
△		
△		
△		
△		
REV		
NOTES		
PAGE	TOTAL	
INSTITUTION		
Departement of Architecture		
UNIVERSITAS ISLAM INDONESIA		

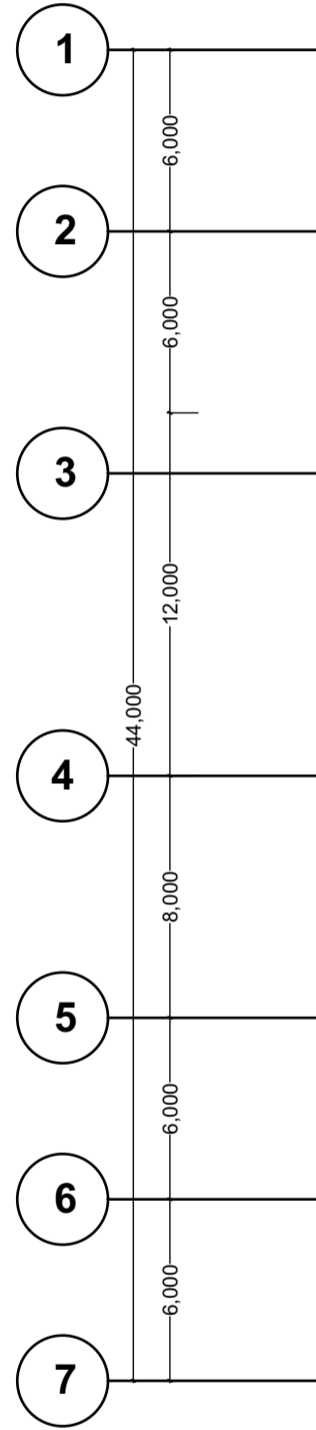

**LEGENDA**

- POLA PAVEMENT PEDESTRIAN BANGUNAN
- PAVEMENT BATA MERAH
- LANTAI KERAMIK
- POLA PAVEMENT PEDESTRIAN JALAN
- BETON
- RUMPUT GAJAH
- LANTAI KERAMIK
- POLA PAVEMENT PEDESTRIAN JALAN
- POHON ANGSANA

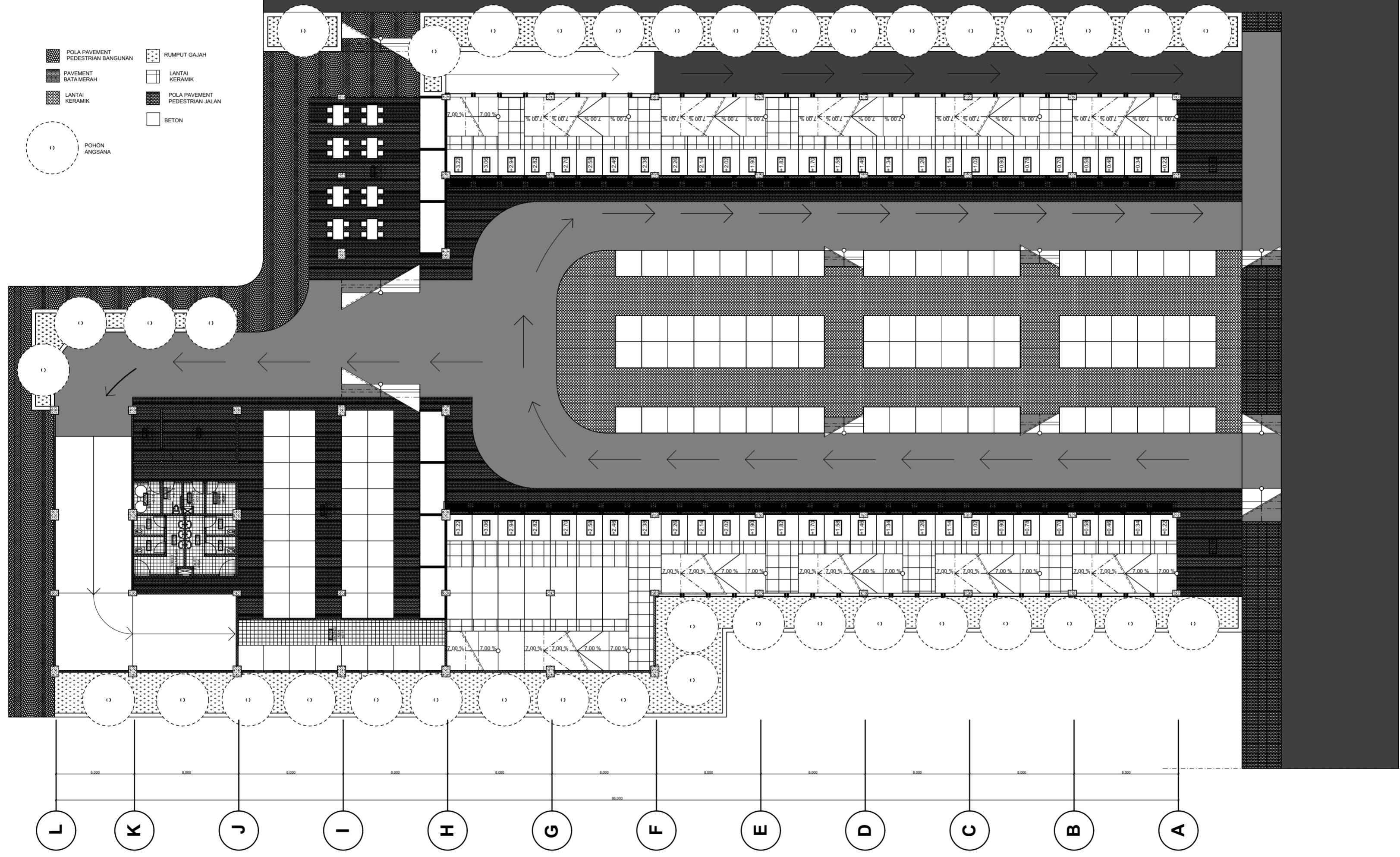

<b>PLANNING CONSULTANT</b>		
<b>PROJECT</b>		
RE-DESIGN PASAR LEMPUYANGAN YOGYAKARTA		
<b>OWNER</b>		
PT. LEMPUYANGAN		
<b>CHIEF ARCHITECT</b>	<b>ID</b>	
HAFIAN AKBAR	14512202	
<b>TEAM NAME</b>	<b>ID</b>	
<b>IN HOUSE ARCHITECT</b>		
<b>CLIENT</b>		
Syarifah Ismailiyah A., ST., MT., IAI		
<b>DRAWING TITLE</b>		
RENCANA TAPAK		
<b>DRAWING BY</b> HAFIAN AKBAR		
<b>STATUS</b>		
<b>SCALE</b> 1:250	<b>FILE NO.</b> A-14	
	<b>NAME</b>	<b>SIGN</b> <b>DATE</b>
<b>DRAWN BY</b>		
<b>CHECKED BY</b>		
<b>REVIEWED &amp; APPROVED BY</b>		
<b>DRAWING NO.</b>		
<b>DESCRIPTION</b>		
<b>APPROVAL</b>		
△		
△		
△		
△		
△		
△		
<b>NOTES</b>		
<b>PAGE</b>	<b>TOTAL</b>	
<b>INSTITUTION</b>		
Departement of Architecture UNIVERSITAS ISLAM INDONESIA		

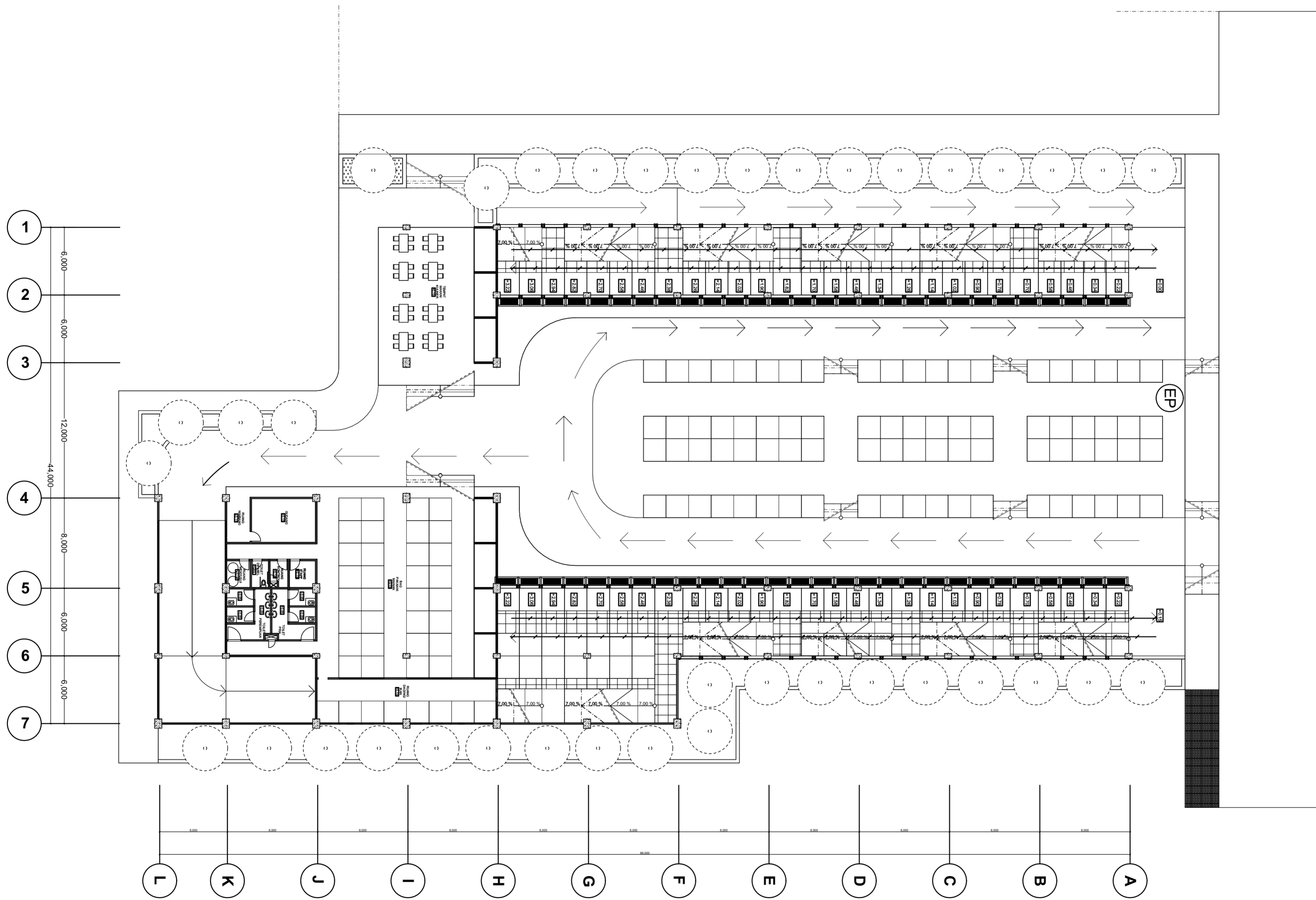

PLANNING  
CONSULTANT

PROJECT  
RE-DESIGN PASAR LEMPUYANGAN  
YOGYAKARTA  
OWNER  
PT. LEMPUYANGAN  
CHIEF ARCHITECT ID  
HAFIAN AKBAR 14512202  
TEAM NAME ID

IN HOUSE ARCHITECT  
CLIENT  
Syarifah Ismailiyah A., ST., MT., IAI

DRAWING TITLE  
**RENCANA  
SIRKULASI**  
DRAWING BY HAFIAN AKBAR

STATUS  
SCALE 1:250 FILE NO. ME-06

NAME	SIGN	DATE
DRAWN BY		
CHECKED BY		
REVIEWED & APPROVED BY		

DRAWING NO.

DESCRIPTION

APPROVAL

△		
△		
△		
△		
△		
REV		

NOTES  
PAGE TOTAL

INSTITUTION  
Departement of Architecture  
UNIVERSITAS ISLAM INDONESIA





PLANNING CONSULTANT		
PROJECT		
RE-DESIGN PASAR LEMPUYANGAN YOGYAKARTA		
OWNER		
PT. LEMPUYANGAN		
CHIEF ARCHITECT	ID	
HAFIAN AKBAR	14512202	
TEAM NAME	ID	
IN HOUSE ARCHITECT		
CLIENT		
Syarifah Ismailiyah A., ST., MT., IAI		
DRAWING TITLE		
DRAWING BY HAFIAN AKBAR		
STATUS		
SCALE	FILE NO.	
	NAME	SIGN
		DATE
DRAWN BY		
CHECKED BY		
REVIEWED & APPROVED BY		
DRAWING NO.		
DESCRIPTION		
APPROVAL		
△		
△		
△		
△		
REV		
NOTES		
PAGE	TOTAL	
INSTITUTION		
Departement of Architecture UNIVERSITAS ISLAM INDONESIA		

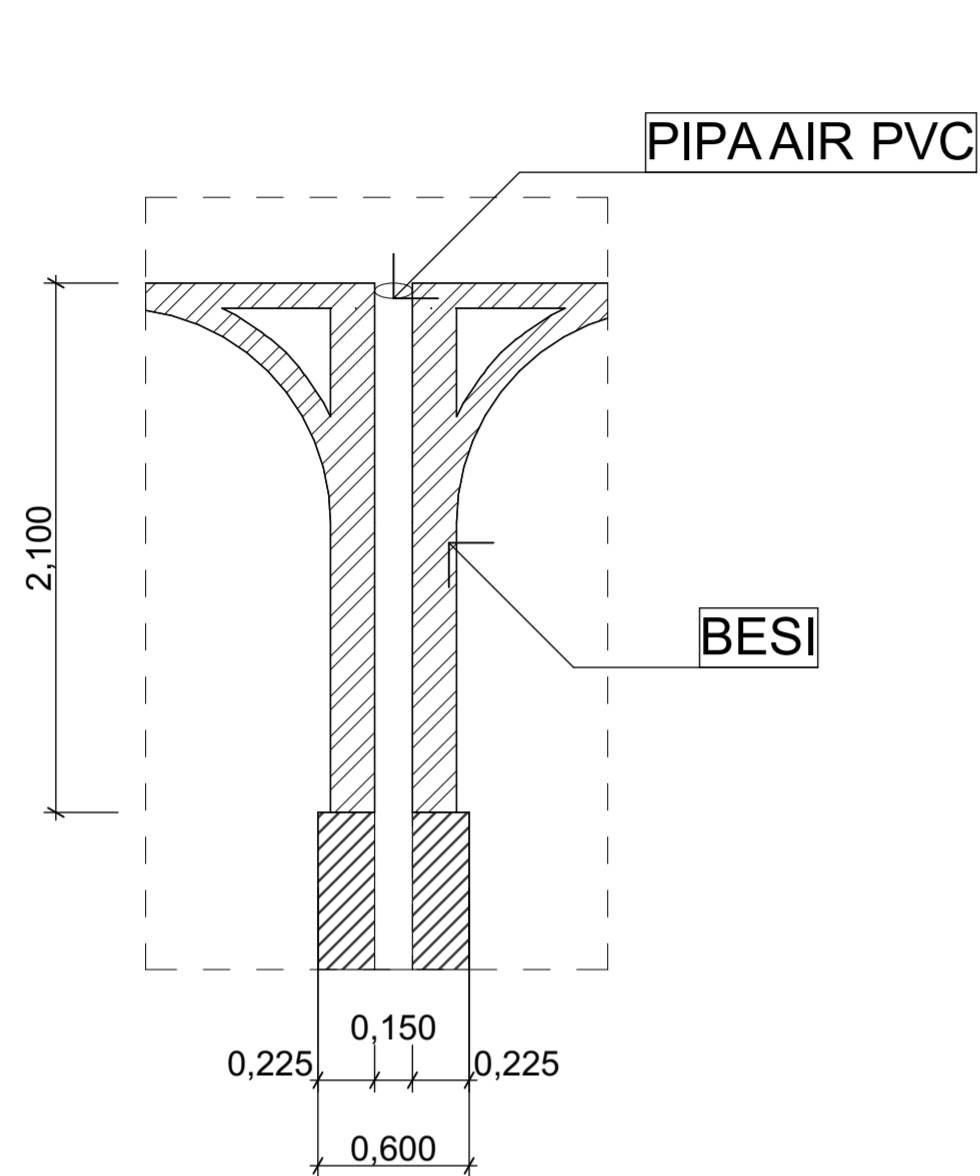

D-02 Detail 1:30

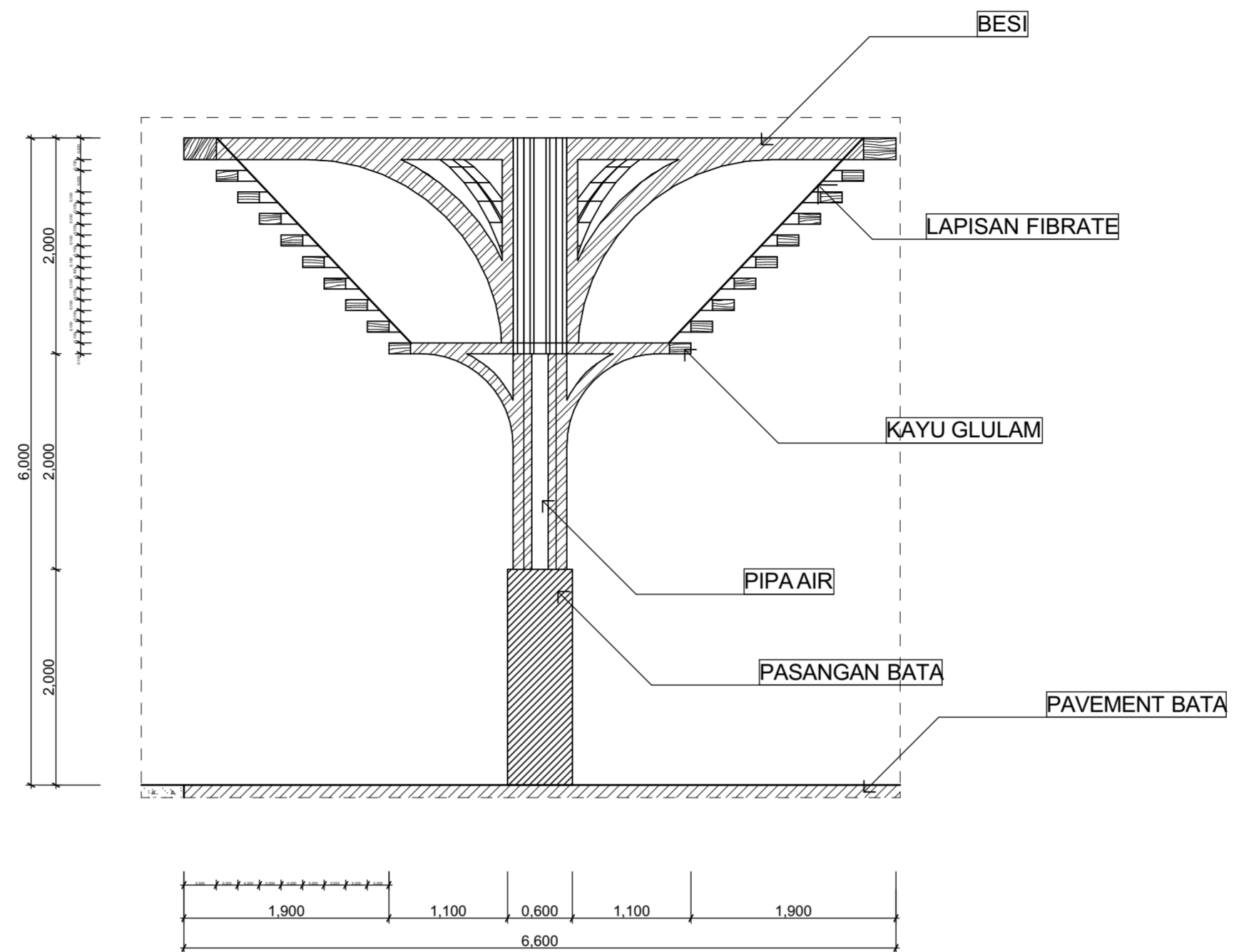

D-01 Detail 1:50

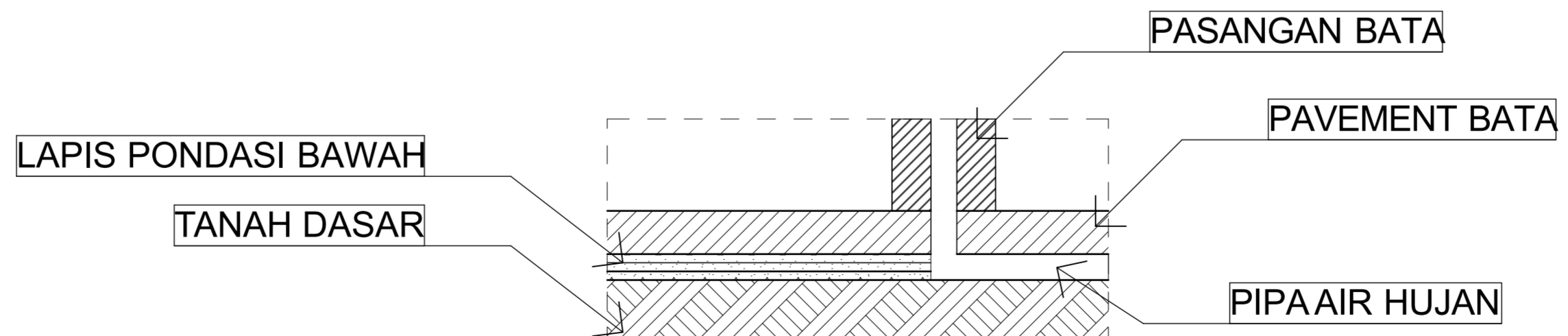

D-03 Detail 1:30

EKSTERIOR



TAMPAK LUAR PADA BANGUNAN

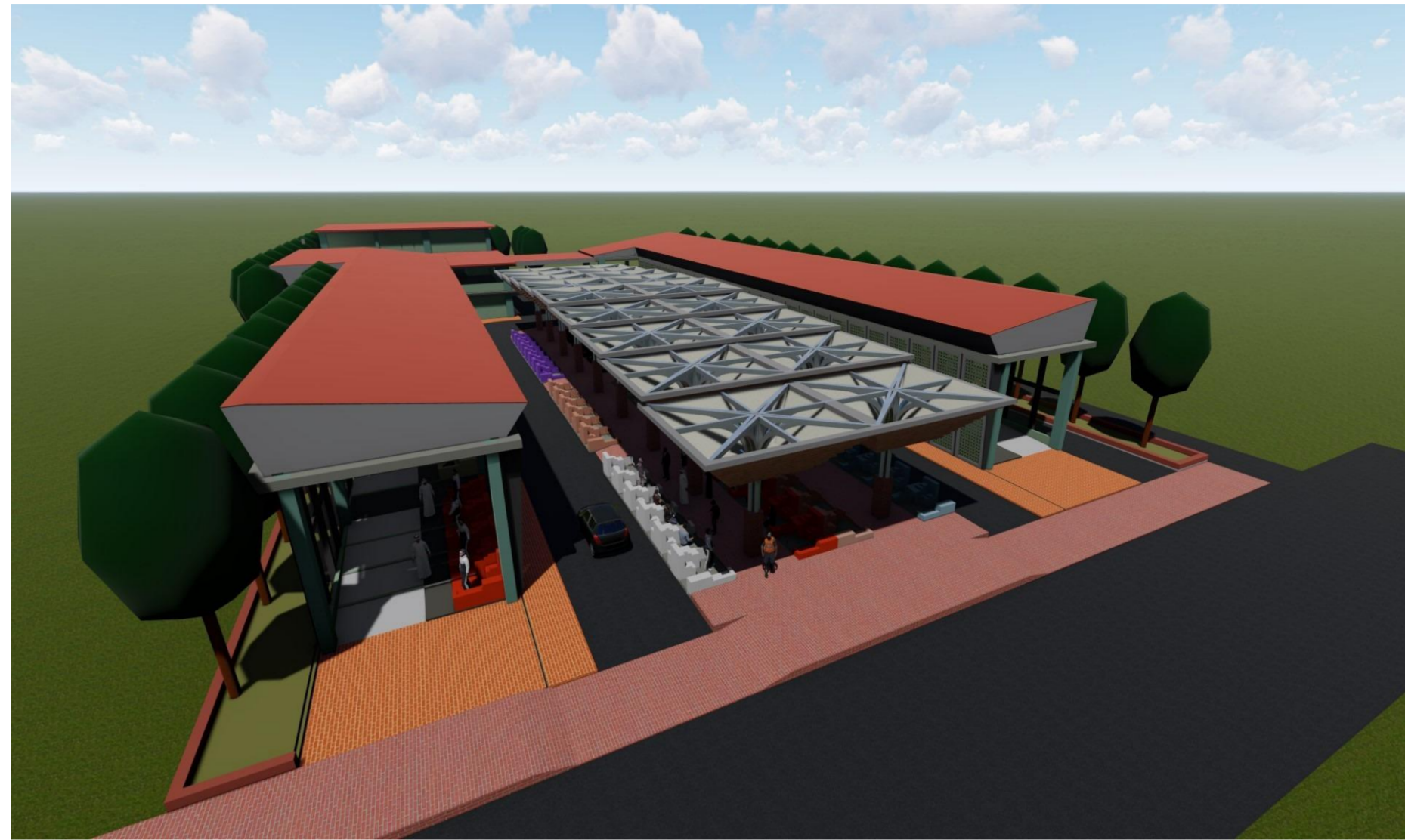

EKSTERIOR BANGUNAN KESELURUHAN

INTERIOR

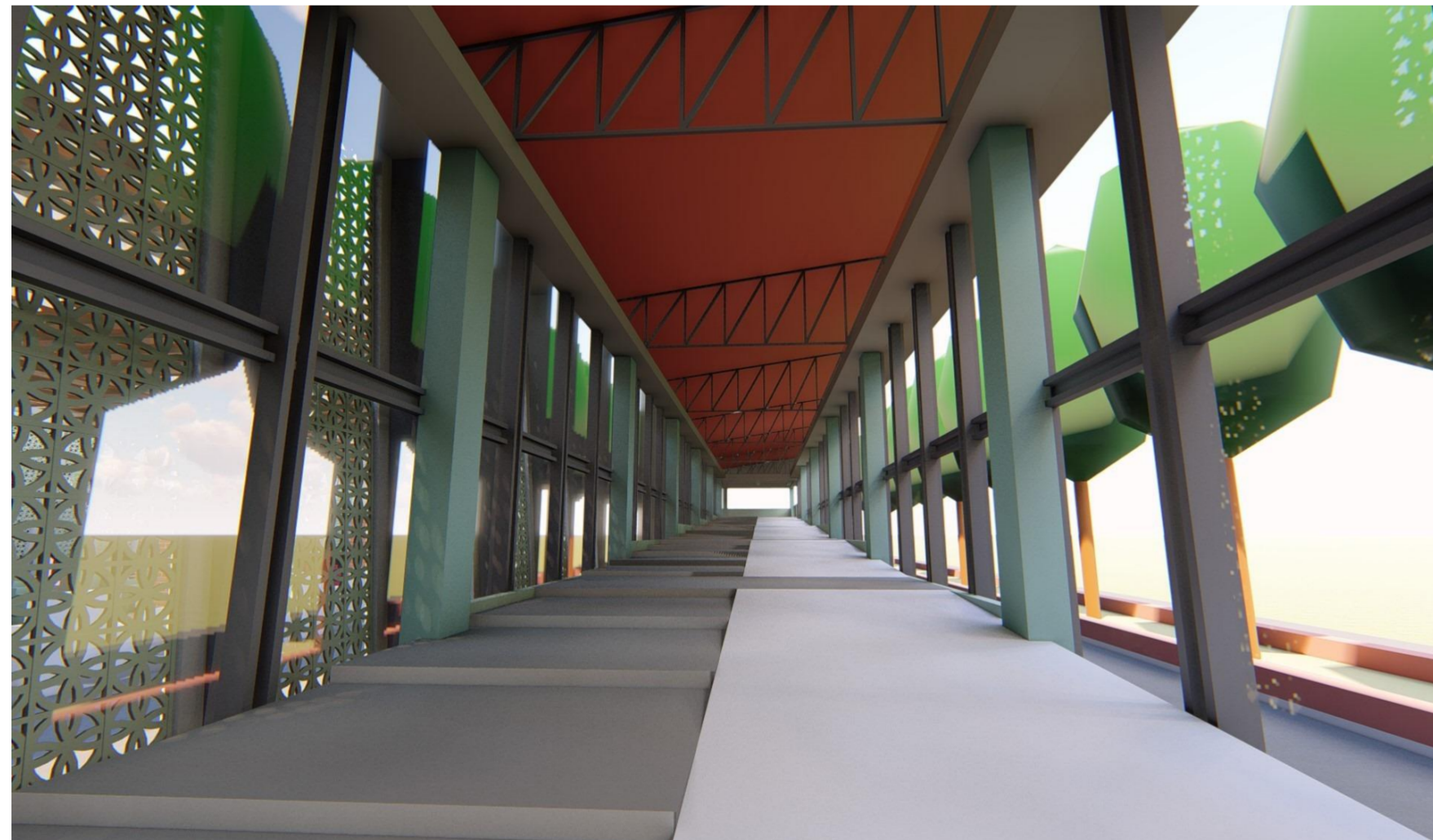

INTERIOR BANGUNAN



INTERIOR PASAR BAGIAN DAGING

PLANNING CONSULTANT			
PROJECT			
RE-DESIGN PASAR LEMPUYANGAN YOGYAKARTA			
OWNER			
PT. LEMPUYANGAN			
CHIEF ARCHITECT	ID		
HAFIAN AKBAR	14512202		
TEAM NAME	ID		
IN HOUSE ARCHITECT			
CLIENT			
Syarifah Ismailiyah A., ST., MT., IAI			
DRAWING TITLE			
DRAWING BY HAFIAN AKBAR			
STATUS			
SCALE	FILE NO.		
	NAME	SIGN	DATE
DRAWN BY			
CHECKED BY			
REVIEWED & APPROVED BY			
DRAWING NO.			
DESCRIPTION			
APPROVAL			
△			
△			
△			
△			
△			
REV			
NOTES			
PAGE	TOTAL		
INSTITUTION			
Departement of Architecture UNIVERSITAS ISLAM INDONESIA			

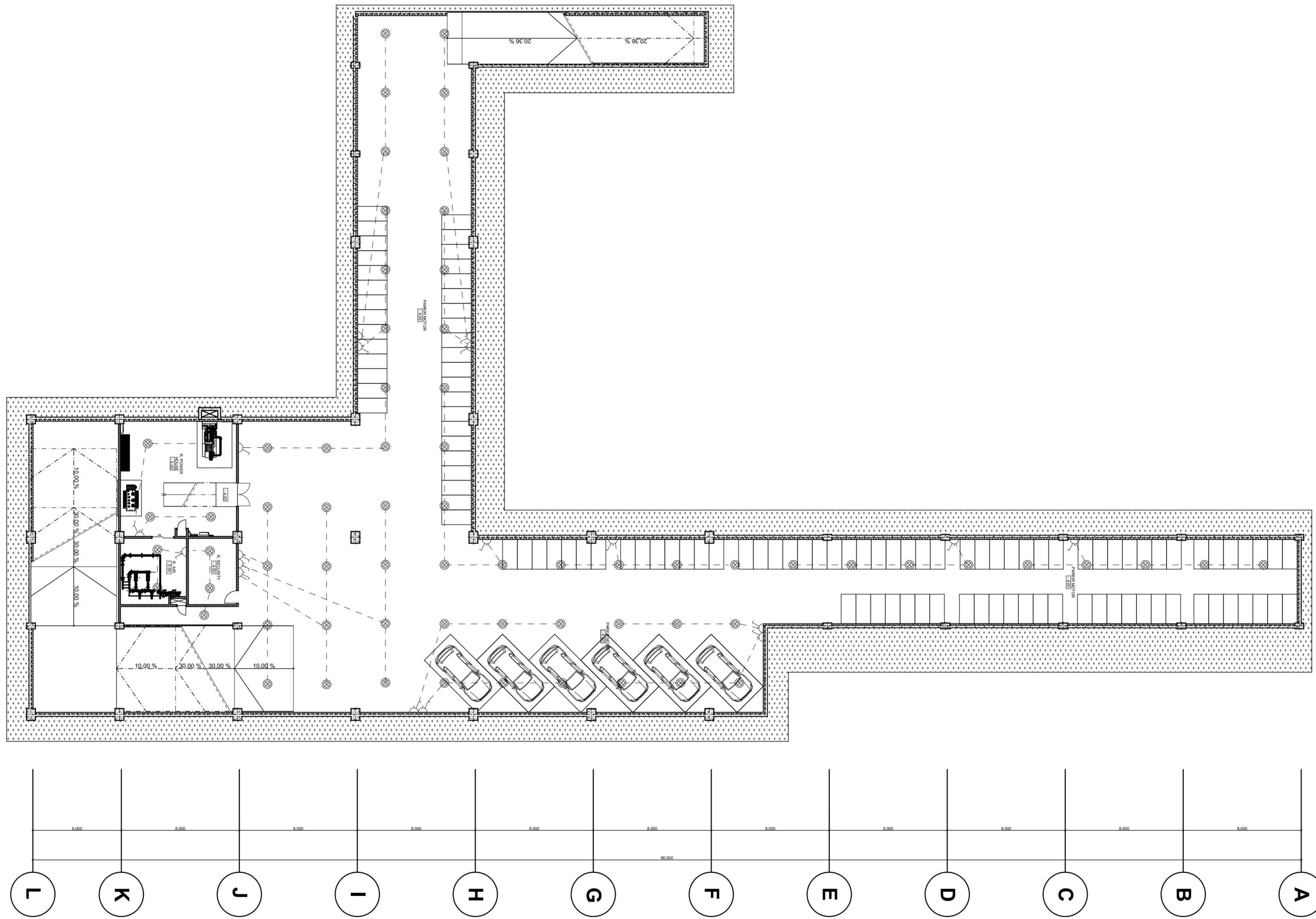

PLANNING CONSULTANT	
PROJECT	
RE-DESIGN PASAR LEMPUYANGAN YOGYAKARTA	
OWNER	
PT. LEMPUYANGAN	
CHIEF ARCHITECT	ID
HAFIAN AKBAR	14512202
TEAM NAME	ID
IN HOUSE ARCHITECT	
CLIENT	
Syarifah Ismailiyah A., ST., MT., IAI	
DRAWING TITLE	
DRAWING BY HAFIAN AKBAR	
STATUS	
SCALE	FILE NO.
	NAME SIGN DATE
DRAWN BY	
CHECKED BY	
REVIEWED & APPROVED BY	
DRAWING NO.	
DESCRIPTION	
<ul style="list-style-type: none"> <li>⌘ STOP KONTAK</li> <li>⊙ LAMPU</li> </ul>	
APPROVAL	
△	
△	
△	
△	
REV	
NOTES	
PAGE	TOTAL
INSTITUTION	
Departement of Architecture UNIVERSITAS ISLAM INDONESIA	
	

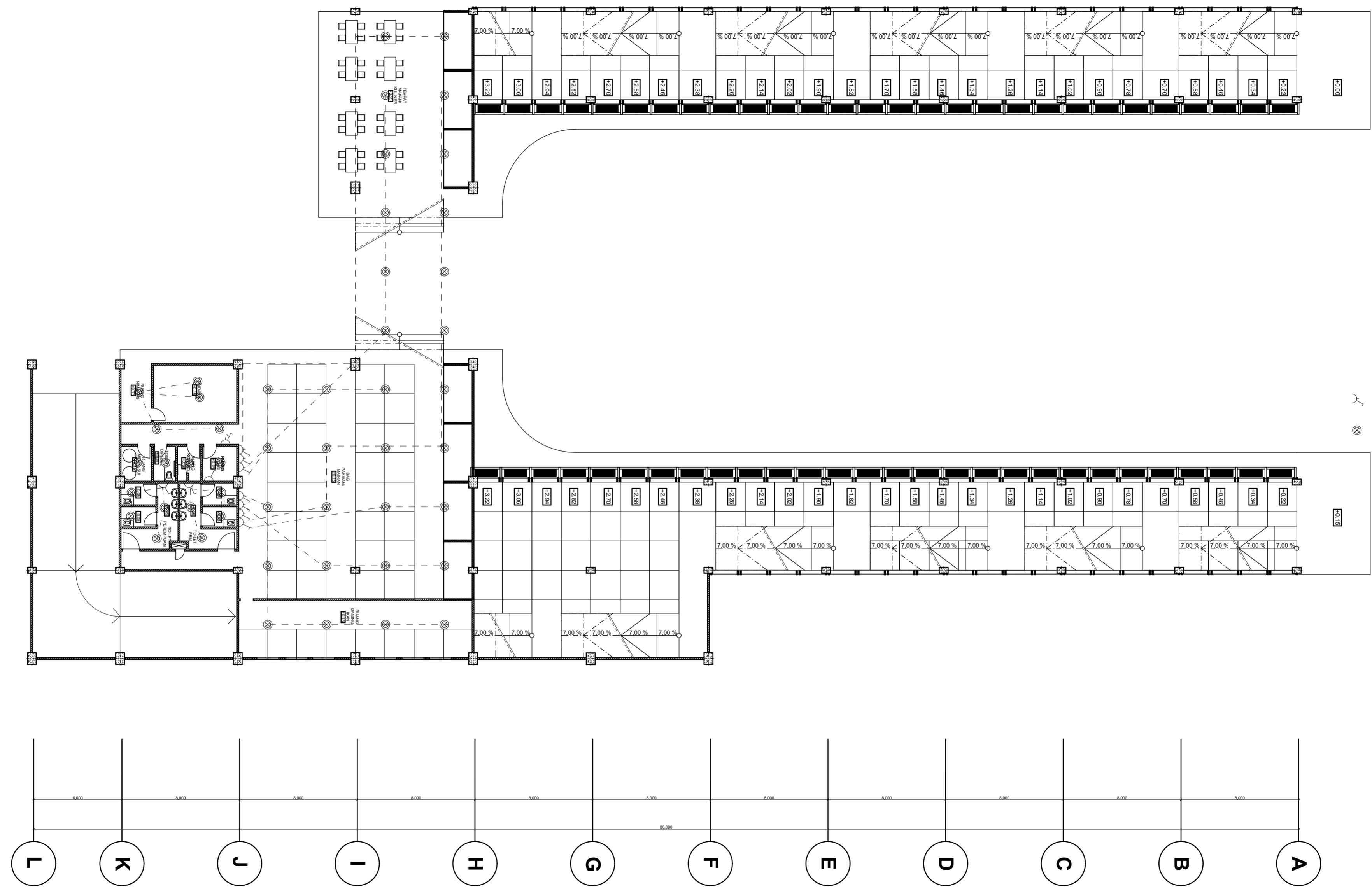
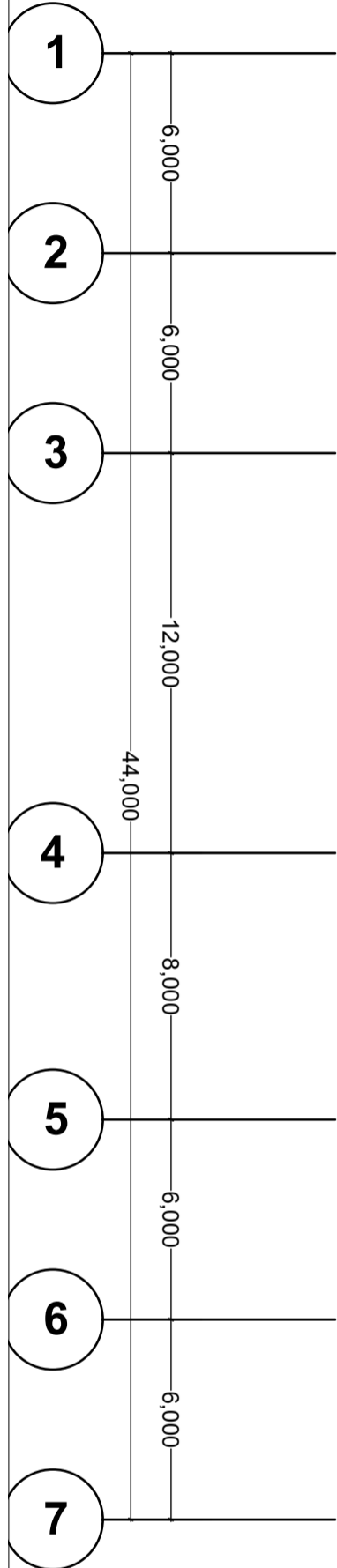

PLANNING CONSULTANT	
PROJECT	
RE-DESIGN PASAR LEMPUYANGAN YOGYAKARTA	
OWNER	
PT. LEMPUYANGAN	
CHIEF ARCHITECT	ID
HAFIAN AKBAR	14512202
TEAM NAME	ID
IN HOUSE ARCHITECT	
CLIENT	
Syarifah Ismailiyah A., ST., MT., IAI	
DRAWING TITLE	
DRAWING BY HAFIAN AKBAR	
STATUS	
SCALE	FILE NO.
	NAME SIGN DATE
DRAWN BY	
CHECKED BY	
REVIEWED & APPROVED BY	
DRAWING NO.	
DESCRIPTION	
<ul style="list-style-type: none"> <li> STOP KONTAK</li> <li> LAMPU</li> </ul>	
APPROVAL	
△	
△	
△	
△	
△	
REV	
NOTES	
PAGE	TOTAL
INSTITUTION	
Departement of Architecture UNIVERSITAS ISLAM INDONESIA	

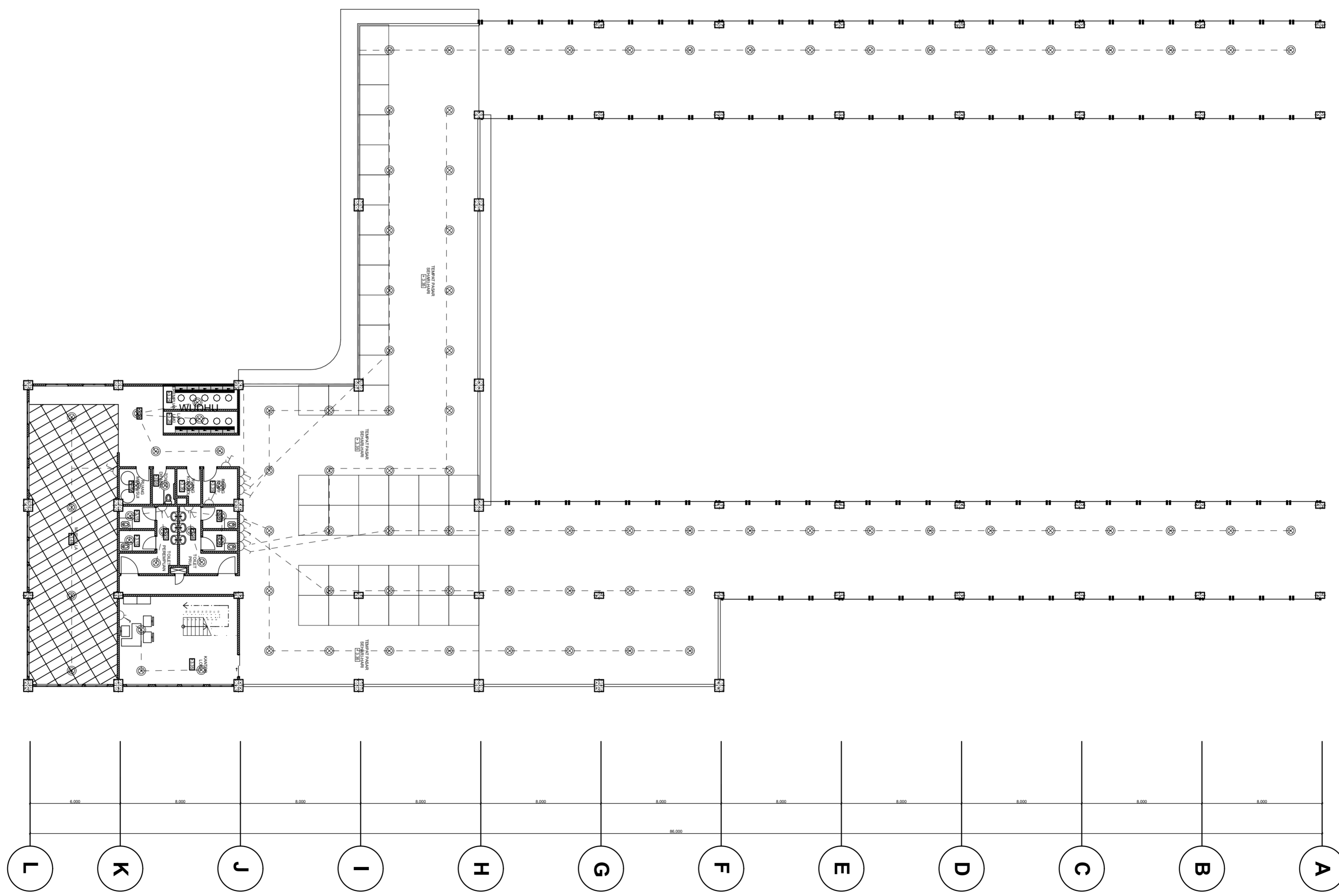

PLANNING CONSULTANT	
PROJECT	
RE-DESIGN PASAR LEMPUYANGAN YOGYAKARTA	
OWNER	
PT. LEMPUYANGAN	
CHIEF ARCHITECT	ID
HAFIAN AKBAR	14512202
TEAM NAME	ID
IN HOUSE ARCHITECT	
CLIENT	
Syarifah Ismailiyah A., ST., MT., IAI	
DRAWING TITLE	
DRAWING BY HAFIAN AKBAR	
STATUS	
SCALE	FILE NO.
	NAME SIGN DATE
DRAWN BY	
CHECKED BY	
REVIEWED & APPROVED BY	
DRAWING NO.	
DESCRIPTION	
<ul style="list-style-type: none"> <li>⌘ STOP KONTAK</li> <li>⊗ LAMPU</li> </ul>	
APPROVAL	
△	
△	
△	
△	
△	
REV	
NOTES	
PAGE	TOTAL
INSTITUTION	
Departement of Architecture UNIVERSITAS ISLAM INDONESIA	
	

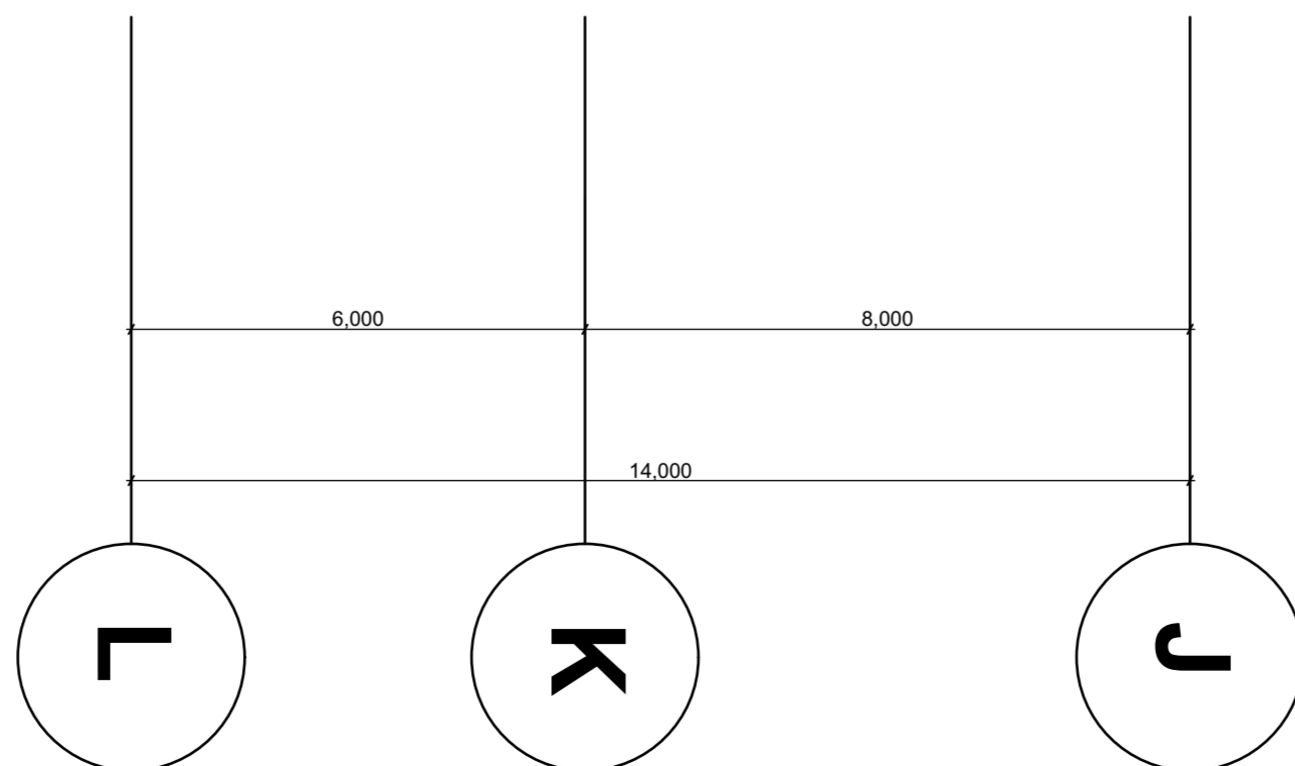
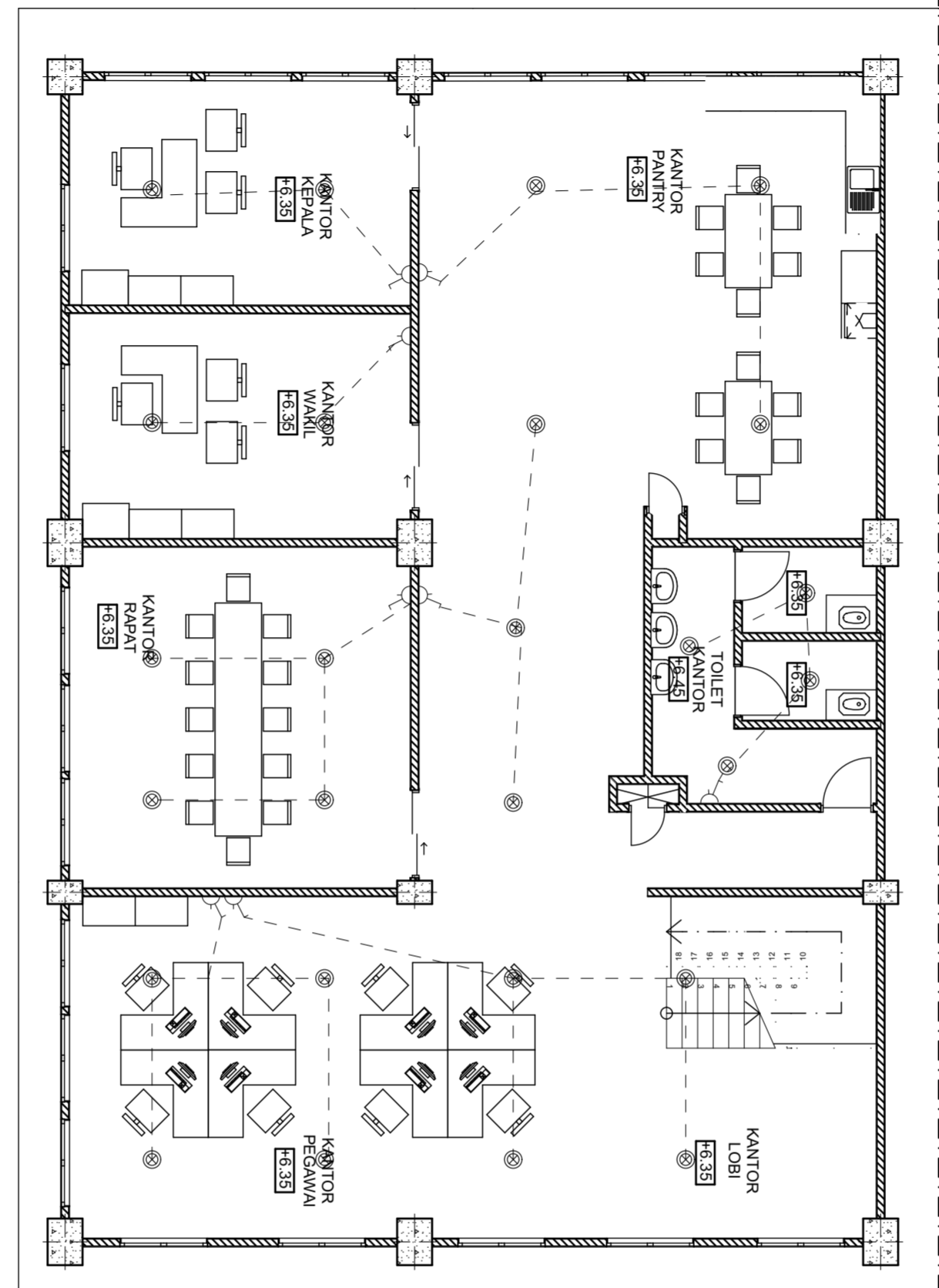
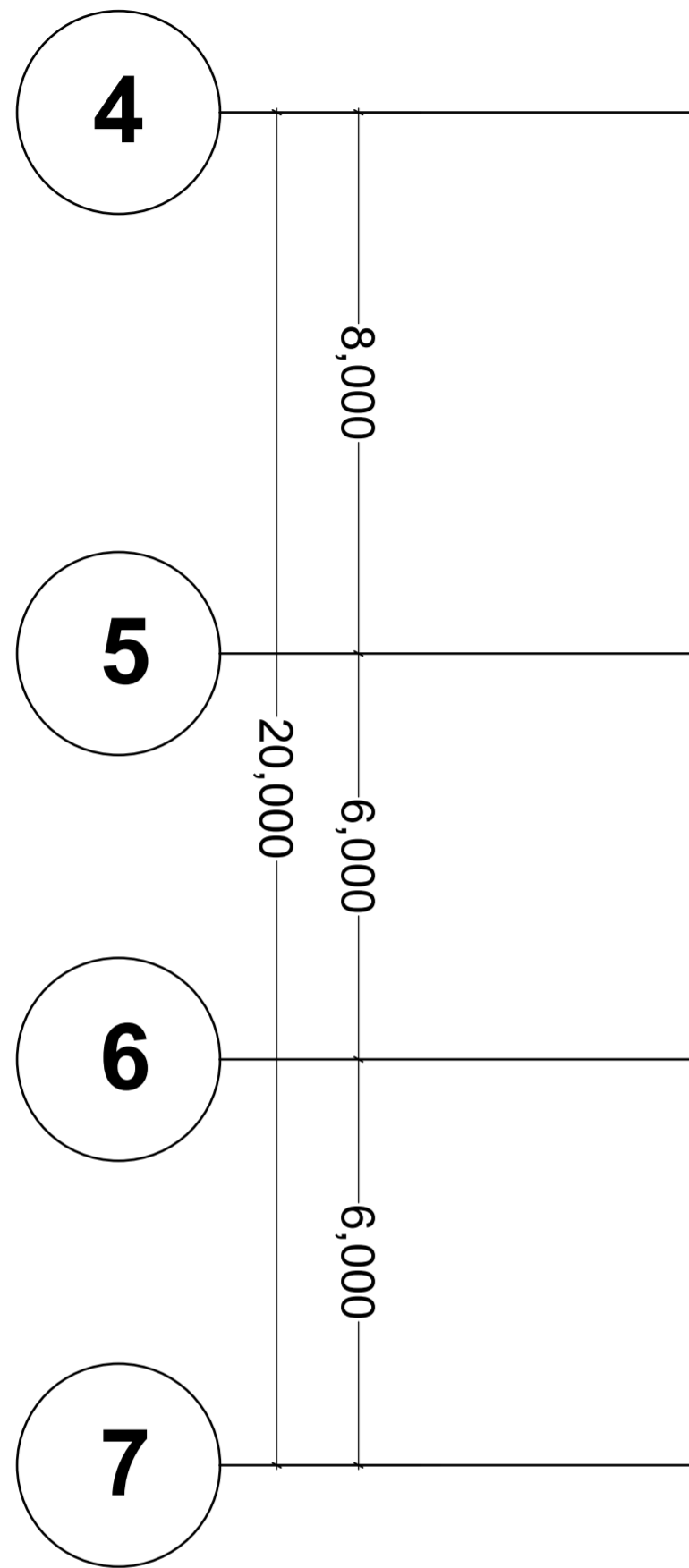

PLANNING CONSULTANT

PROJECT

RE-DESIGN PASAR LEMPUYANGAN  
YOGYAKARTA

OWNER

PT. LEMPUYANGAN

CHIEF ARCHITECT ID

HAFIAN AKBAR 14512202

TEAM NAME ID

IN HOUSE ARCHITECT

CLIENT

Syarifah Ismailiyah A., ST., MT., IAI

DRAWING TITLE

DRAWING BY HAFIAN AKBAR

STATUS

SCALE FILE NO.

NAME SIGN DATE

DRAWN BY

CHECKED BY

REVIEWED & APPROVED BY

DRAWING NO.

DESCRIPTION

STOP KONTAK

LAMPU

APPROVAL

REV

NOTES

PAGE TOTAL

INSTITUTION

Departement of Architecture

UNIVERSITAS ISLAM INDONESIA



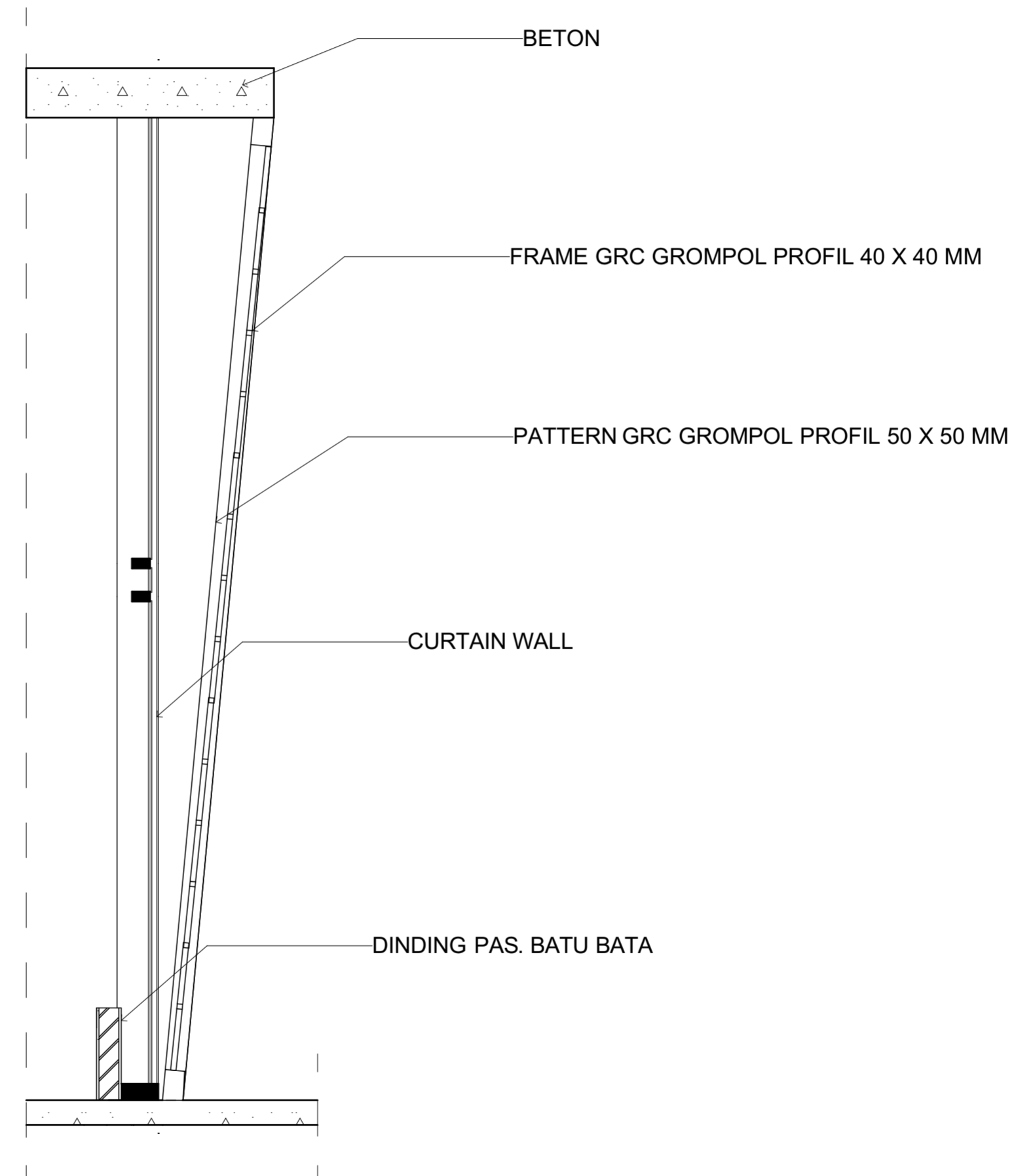
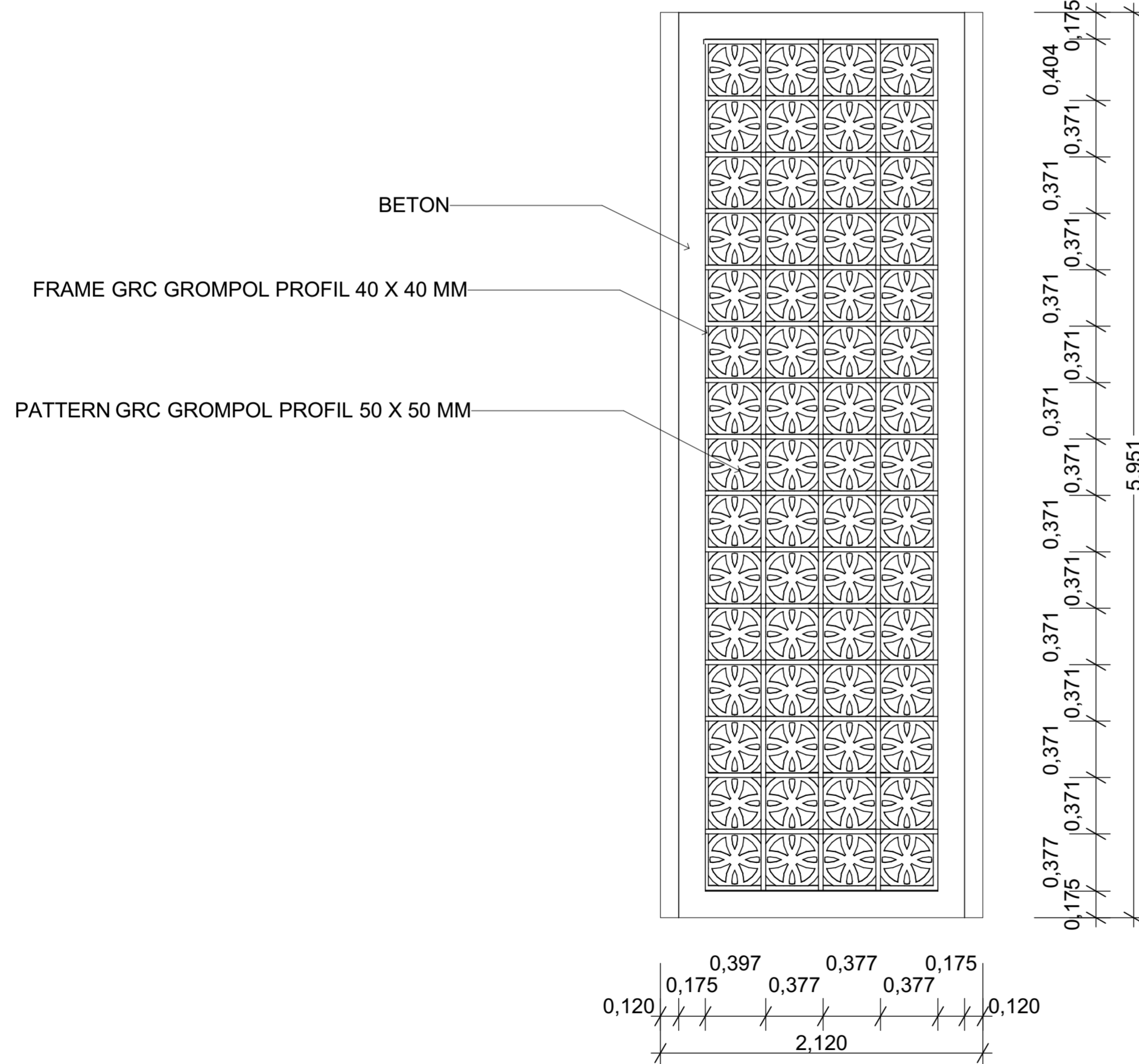
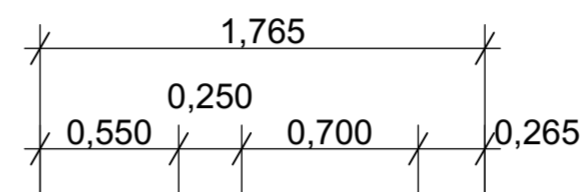
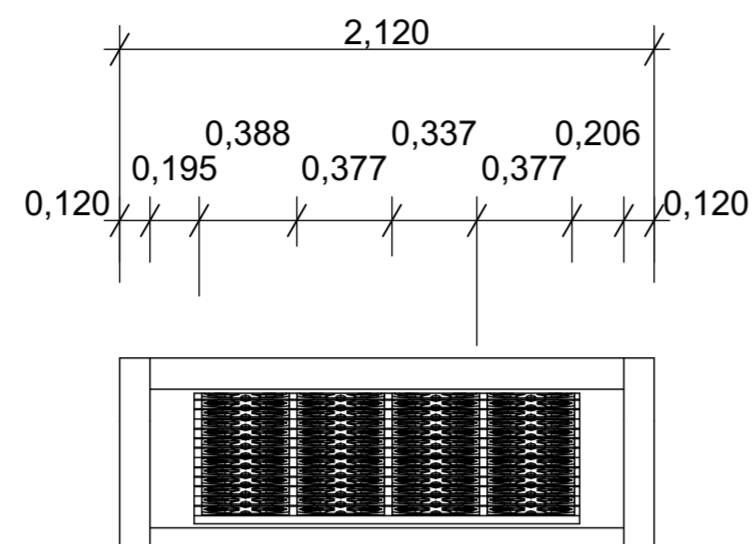

PLANNING CONSULTANT	
PROJECT	
RE-DESIGN PASAR LEMPUYANGAN YOGYAKARTA	
OWNER	
PT. LEMPUYANGAN	
CHIEF ARCHITECT	ID
HAFIAN AKBAR	14512202
TEAM NAME	ID
IN HOUSE ARCHITECT	
CLIENT	
Syarifah Ismailiyah A., ST., MT., IAI	
DRAWING TITLE	
DRAWING BY HAFIAN AKBAR	
STATUS	
SCALE	FILE NO.
	NAME SIGN DATE
DRAWN BY	
CHECKED BY	
REVIEWED & APPROVED BY	
DRAWING NO.	
DESCRIPTION	
APPROVAL	
△	
△	
△	
△	
△	
REV	
NOTES	
PAGE	TOTAL
INSTITUTION	
Departement of Architecture UNIVERSITAS ISLAM INDONESIA	
	

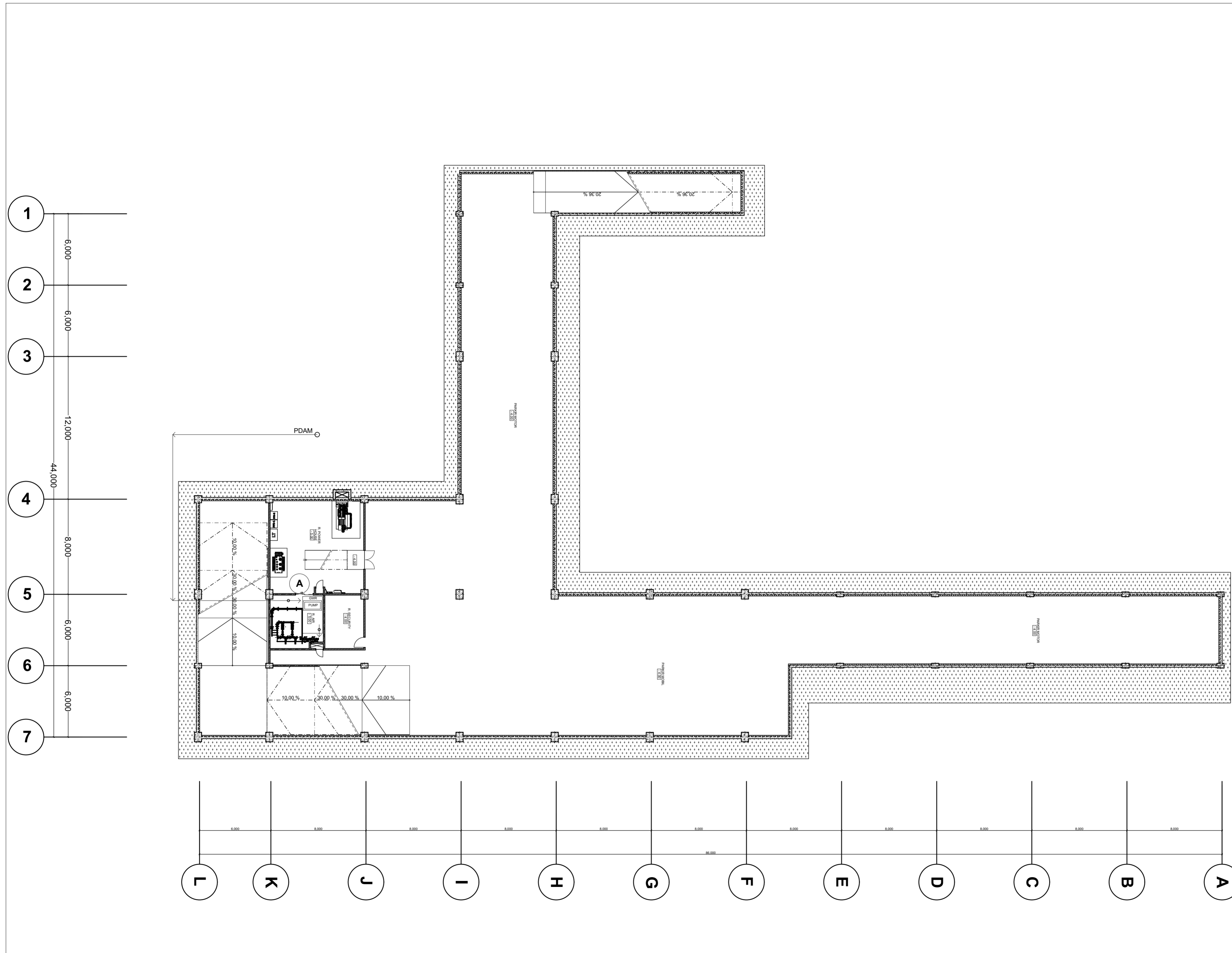

PLANNING CONSULTANT			
PROJECT			
RE-DESIGN PASAR LEMPUYANGAN YOGYAKARTA			
OWNER			
PT. LEMPUYANGAN			
CHIEF ARCHITECT			ID
HAFIAN AKBAR			14512202
TEAM NAME			ID
IN HOUSE ARCHITECT			
CLIENT			
Syarifah Ismailiyah A., ST., MT., IAI			
DRAWING TITLE			
DRAWING BY HAFIAN AKBAR			
STATUS			
SCALE		FILE NO.	
		NAME	SIGN
			DATE
DRAWN BY			
CHECKED BY			
REVIEWED & APPROVED BY			
DRAWING NO.			
DESCRIPTION			
PUMP	POMPA AIR SHIMIZU JET 300 BIT 300 WATT		
GWR	GROUND WATER TANK 4x3x3m		
○→	PIPA DISTRIBUSI AIR BERSIH d= 10cm/ 4"		
APPROVAL			
△			
△			
△			
△			
△			
△			
REV			
NOTES			
PAGE		TOTAL	
INSTITUTION			
Departement of Architecture UNIVERSITAS ISLAM INDONESIA			



# PDAM

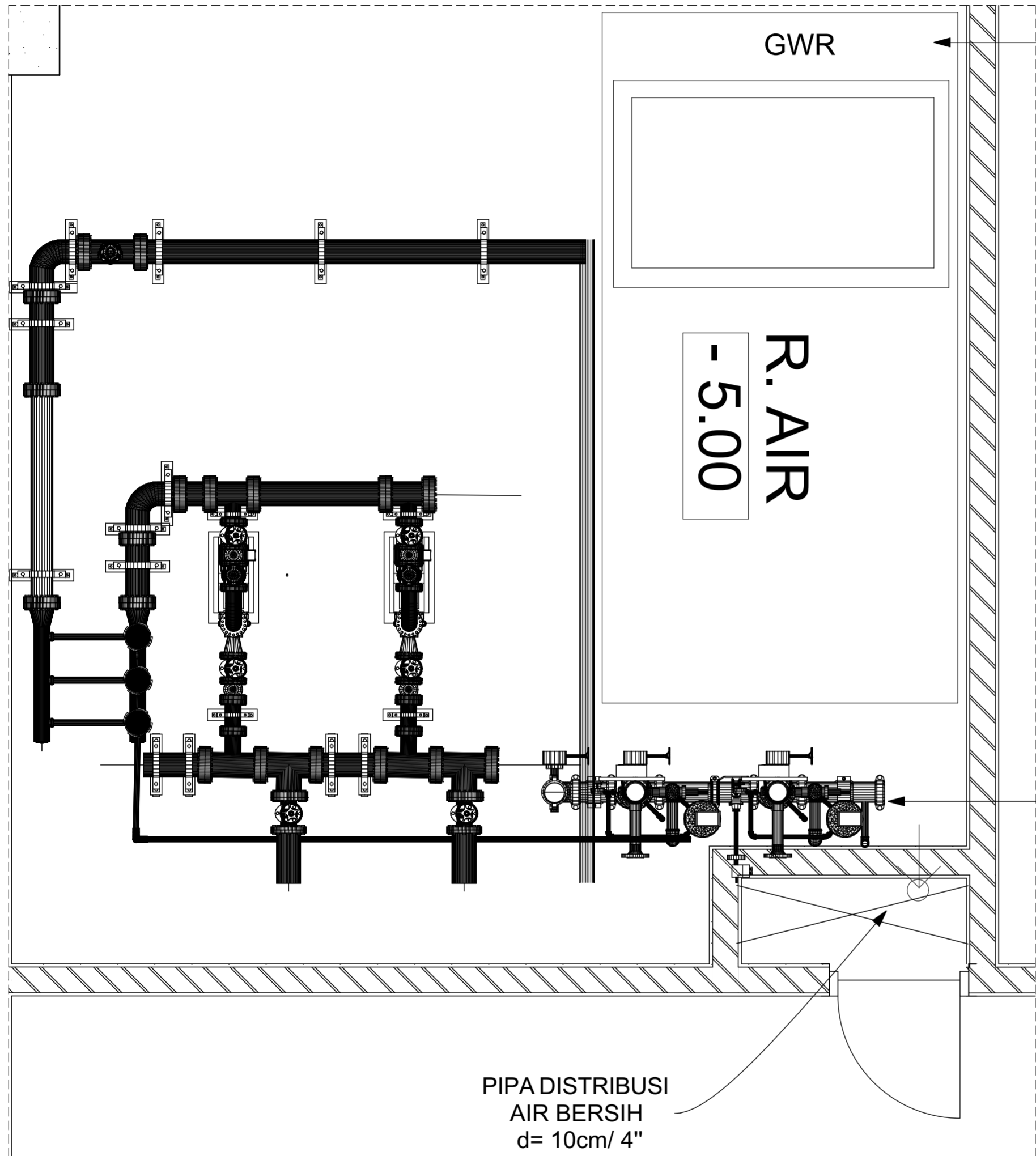

GROUND WATER  
TANK 4x3x3m

POMPA AIR SHIMIZU  
JET 300 BIT  
300 WATT

PIPA DISTRIBUSI  
AIR BERSIH  
d= 10cm/ 4"

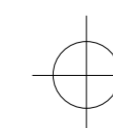
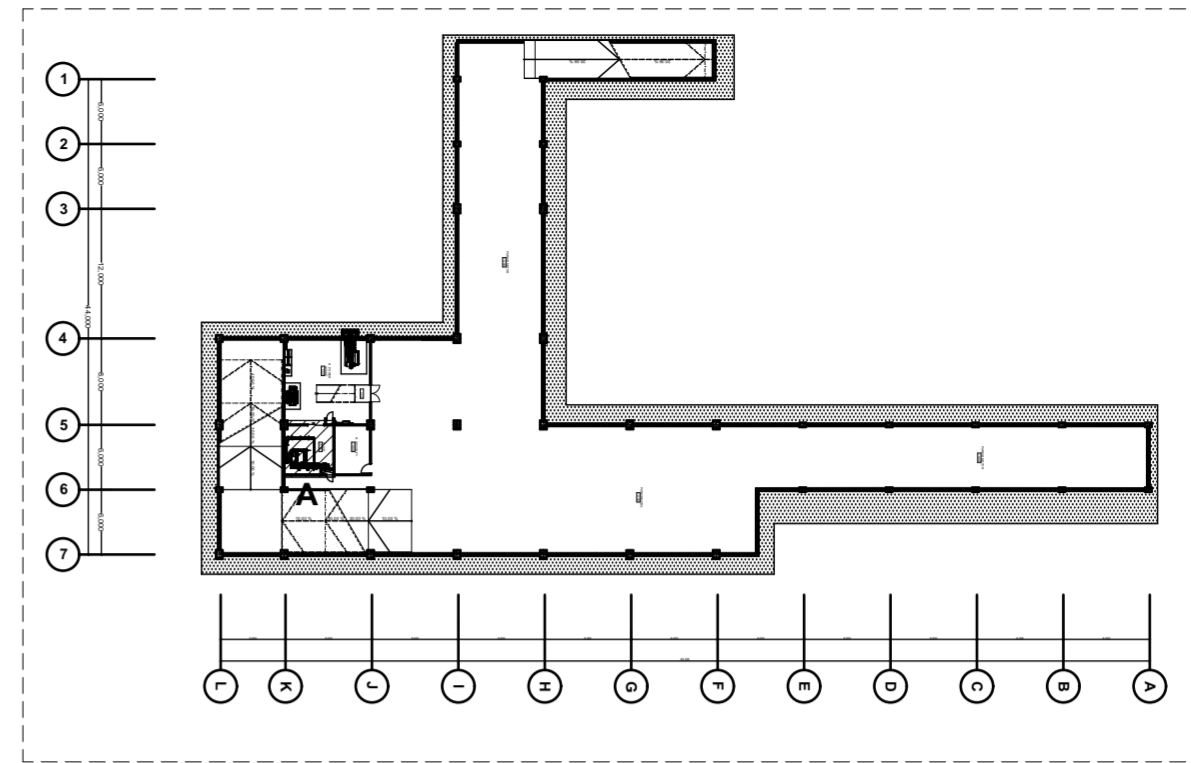

DETAIL A  
SKALA 1:20

PLANNING  
CONSULTANT

PROJECT  
RE-DESIGN PASAR LEMPUYANGAN  
YOGYAKARTA  
OWNER  
PT. LEMPUYANGAN  
CHIEF ARCHITECT  
HAFIAN AKBAR  
TEAM NAME

ID

14512202

ID

IN HOUSE ARCHITECT

CLIENT  
Syarifah Ismailiyah A., ST., MT., IAI

DRAWING TITLE

DRAWING BY HAFIAN AKBAR

STATUS

SCALE FILE NO.

NAME SIGN DATE

DRAWN BY

CHECKED BY

REVIEWED & APPROVED BY

DRAWING NO.

DESCRIPTION

APPROVAL

△			
△			
△			
△			
△			
REV			

NOTES

PAGE TOTAL

INSTITUTION  
Departement of Architecture  
UNIVERSITAS ISLAM INDONESIA



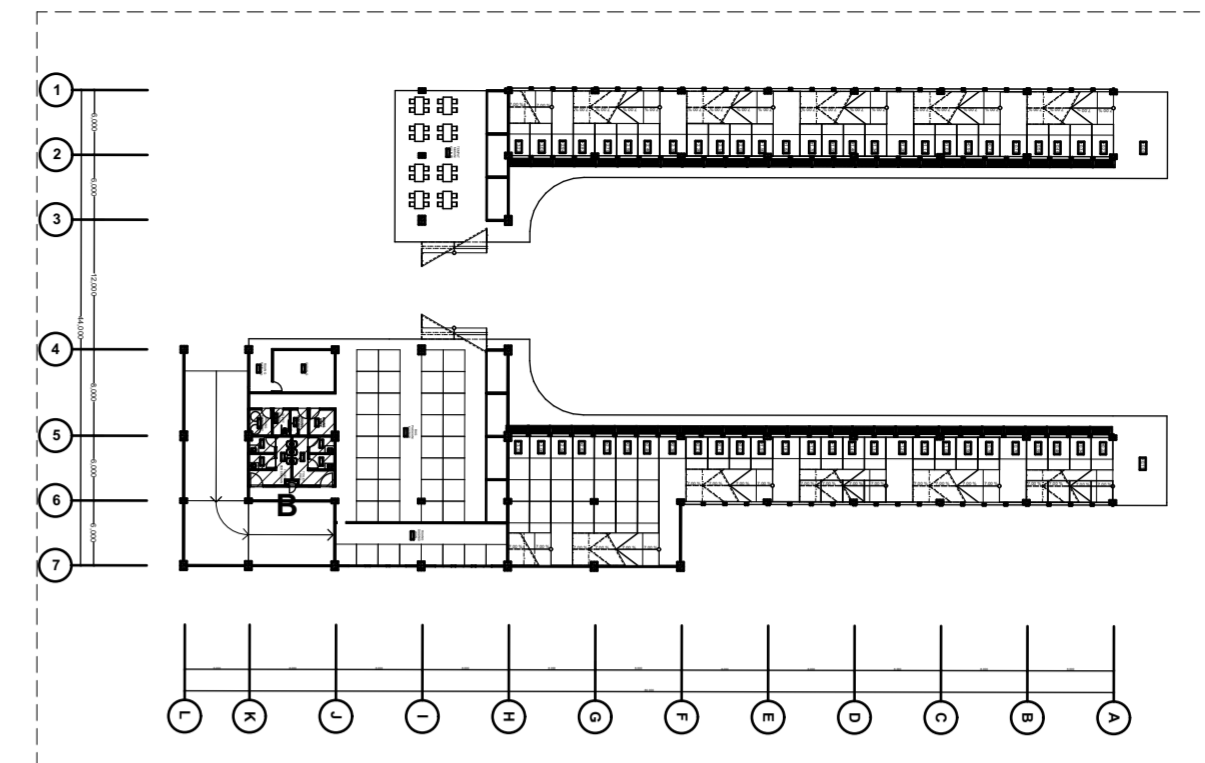
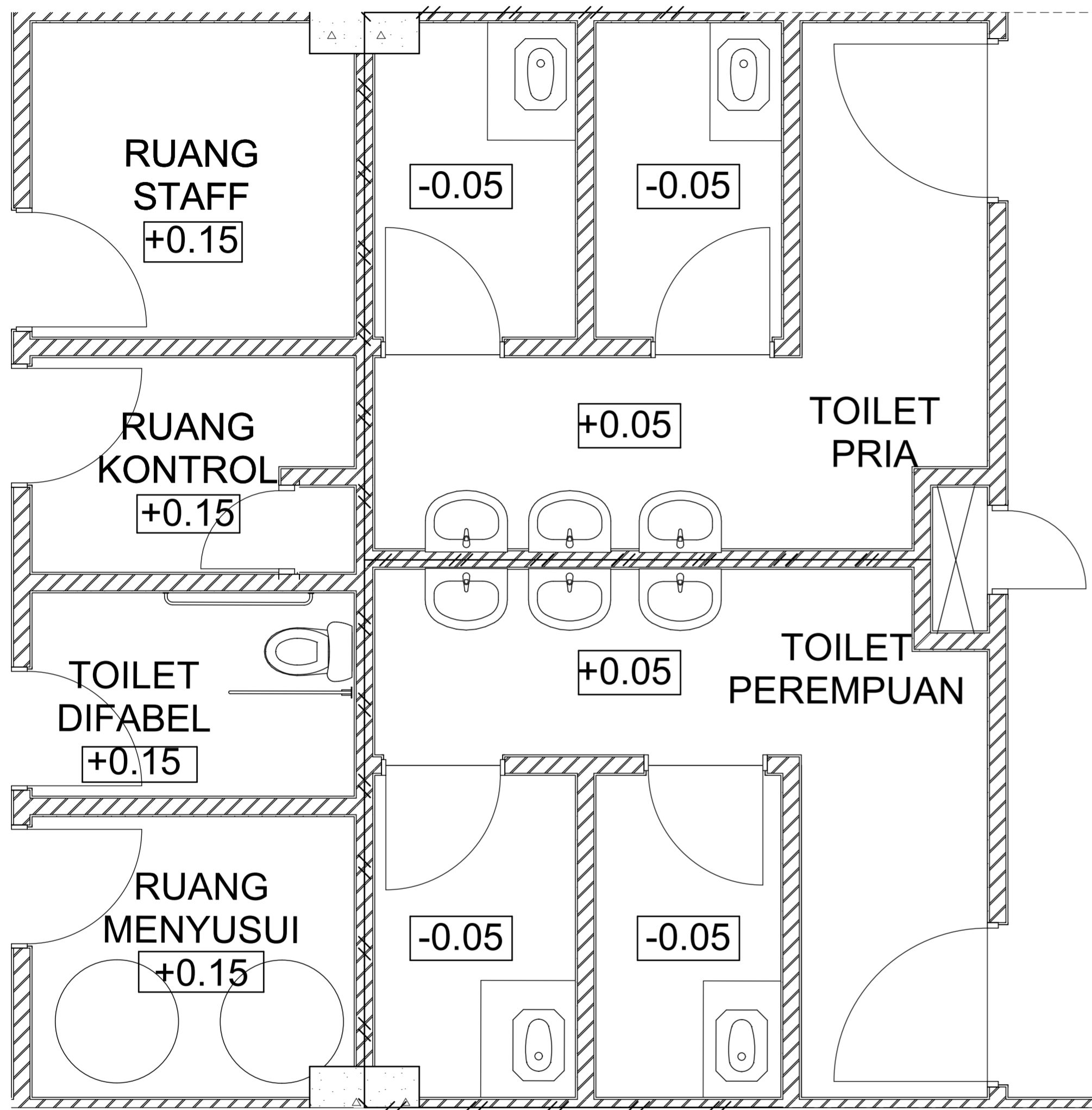

— // — // — : PIPA DISTRIBUSI AIR BERSIH d= 5 cm/ 2" KEMIRINGAN 1 DERAJAT

⊕ DETAIL B  
SKALA 1:30

PLANNING CONSULTANT		
PROJECT		
RE-DESIGN PASAR LEMPUYANGAN YOGYAKARTA		
OWNER		
PT. LEMPUYANGAN		
CHIEF ARCHITECT	ID	
HAFIAN AKBAR	14512202	
TEAM NAME	ID	
IN HOUSE ARCHITECT		
CLIENT		
Syarifah Ismailiyah A., ST., MT., IAI		
DRAWING TITLE		
DRAWING BY HAFIAN AKBAR		
STATUS		
SCALE	FILE NO.	
	NAME	SIGN
		DATE
DRAWN BY		
CHECKED BY		
REVIEWED & APPROVED BY		
DRAWING NO.		
DESCRIPTION		
APPROVAL		
△		
△		
△		
△		
△		
REV		
NOTES		
PAGE	TOTAL	
INSTITUTION		
Departement of Architecture		
UNIVERSITAS ISLAM INDONESIA		

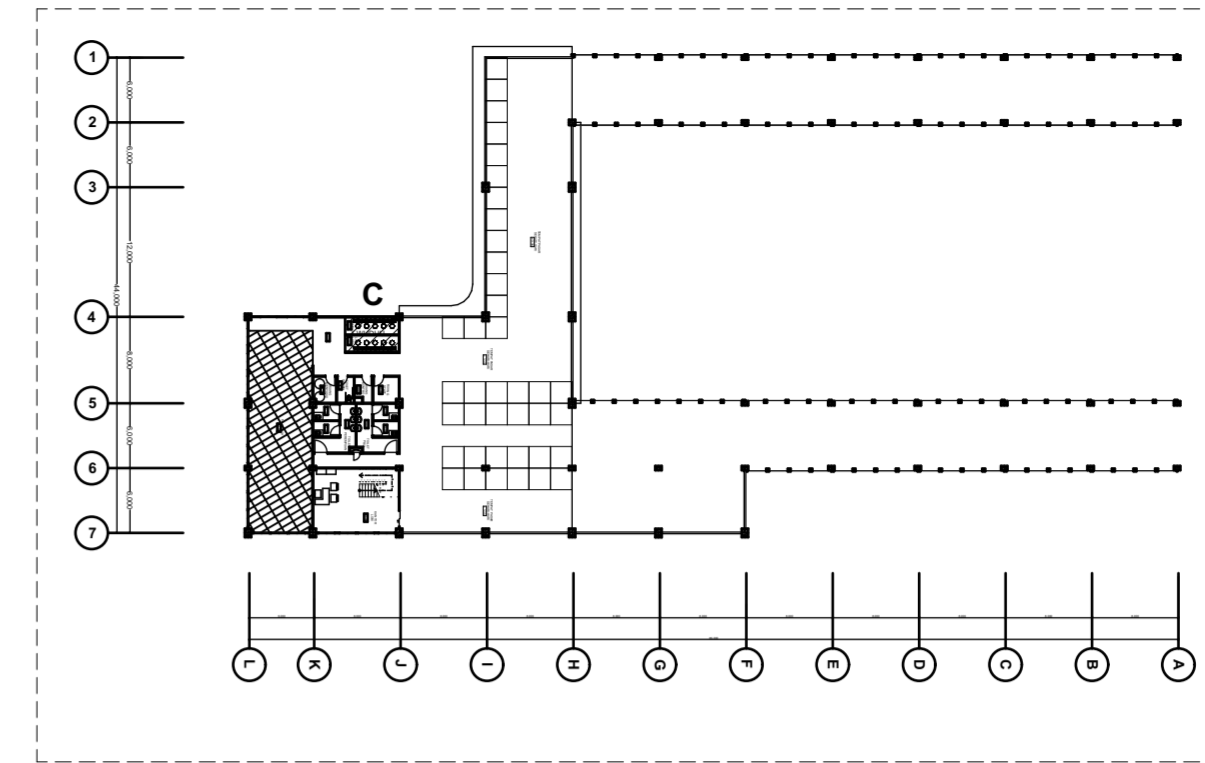
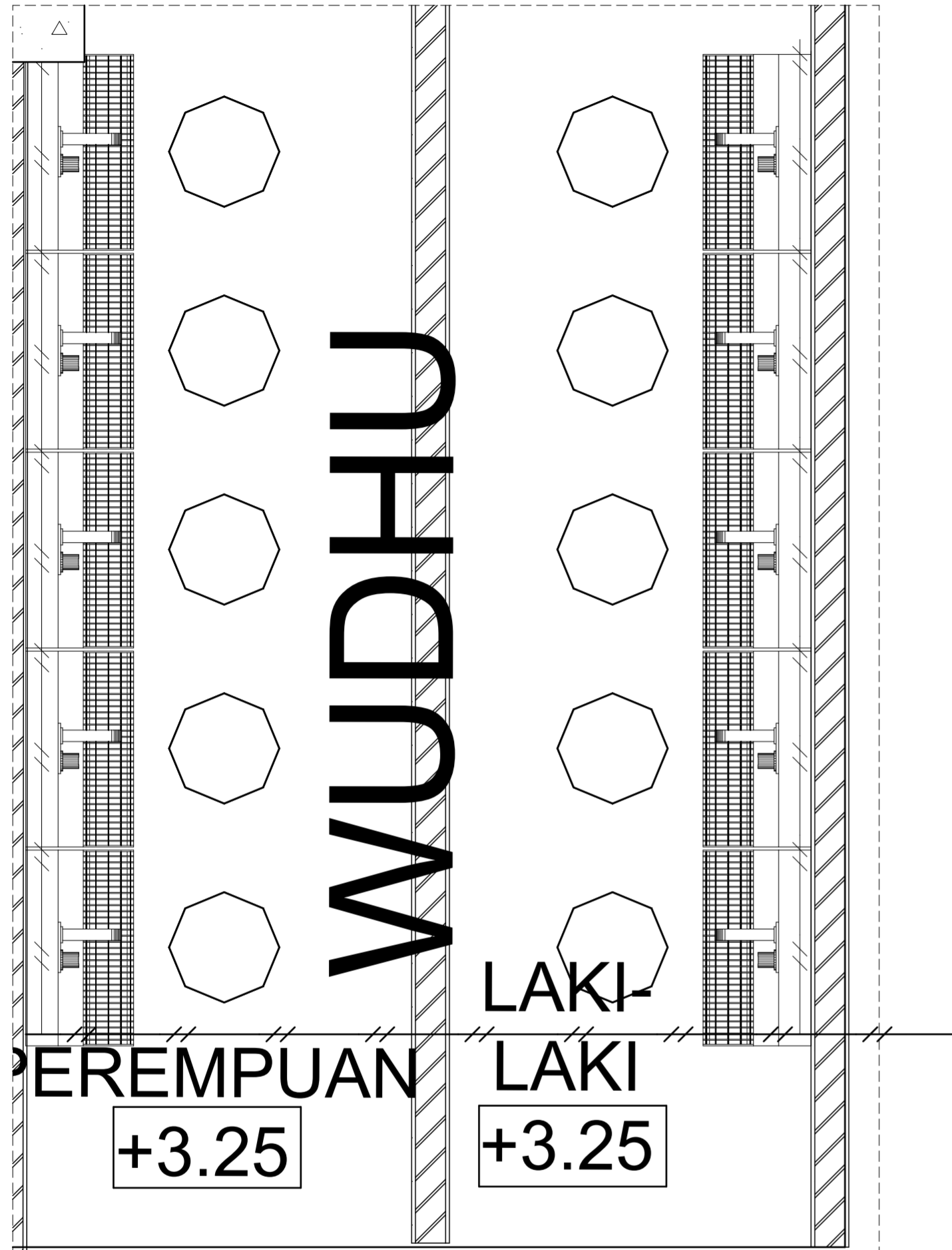

— + — + — +	PIPA DISTRIBUSI AIR BERSIH 2" TIPE AW
TT	KRAN TIPE TOTO T23B13

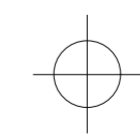
**DETAIL C**  
 SKALA 1:40

PLANNING CONSULTANT	
PROJECT	
RE-DESIGN PASAR LEMPUYANGAN YOGYAKARTA	
OWNER	
PT. LEMPUYANGAN	
CHIEF ARCHITECT	ID
HAFIAN AKBAR	14512202
TEAM NAME	ID
IN HOUSE ARCHITECT	
CLIENT	
Syarifah Ismailiyah A., ST., MT., IAI	
DRAWING TITLE	
DRAWING BY HAFIAN AKBAR	
STATUS	
SCALE	FILE NO.
	NAME SIGN DATE
DRAWN BY	
CHECKED BY	
REVIEWED & APPROVED BY	
DRAWING NO.	
DESCRIPTION	
APPROVAL	
△	
△	
△	
△	
△	
REV	
NOTES	
PAGE	TOTAL
INSTITUTION	
Departement of Architecture UNIVERSITAS ISLAM INDONESIA	
	

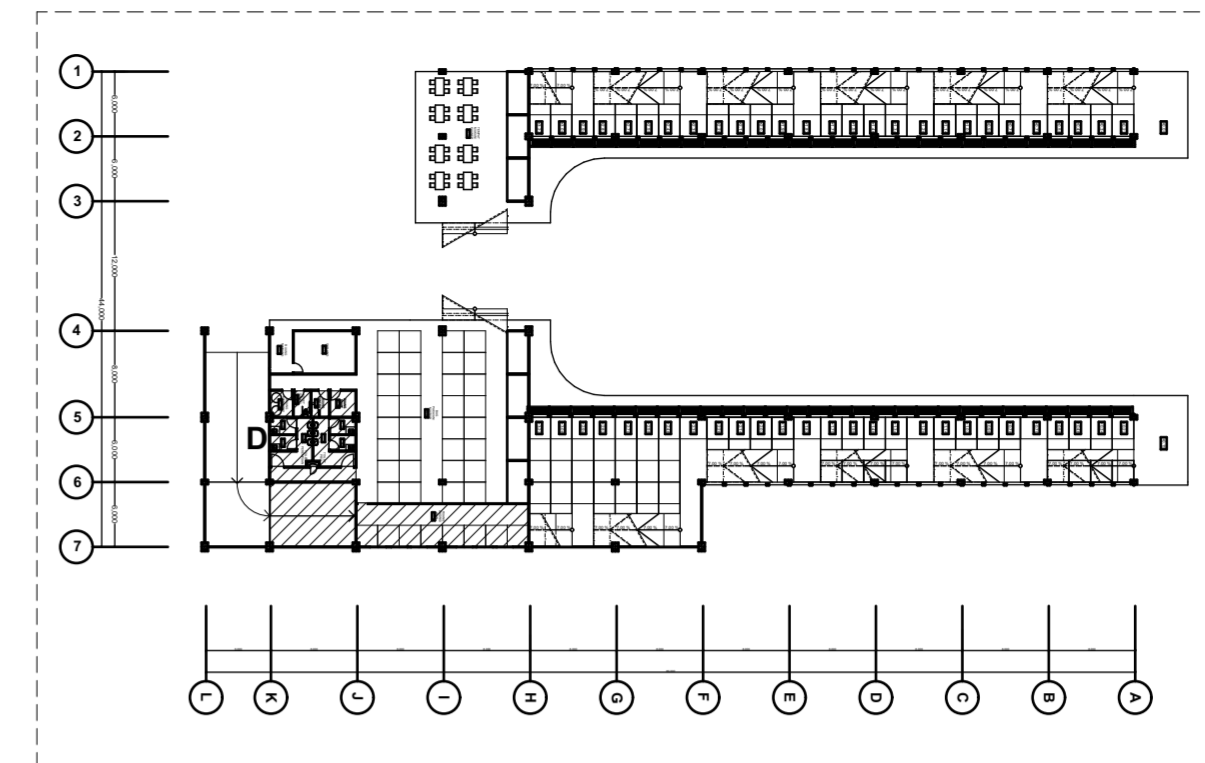
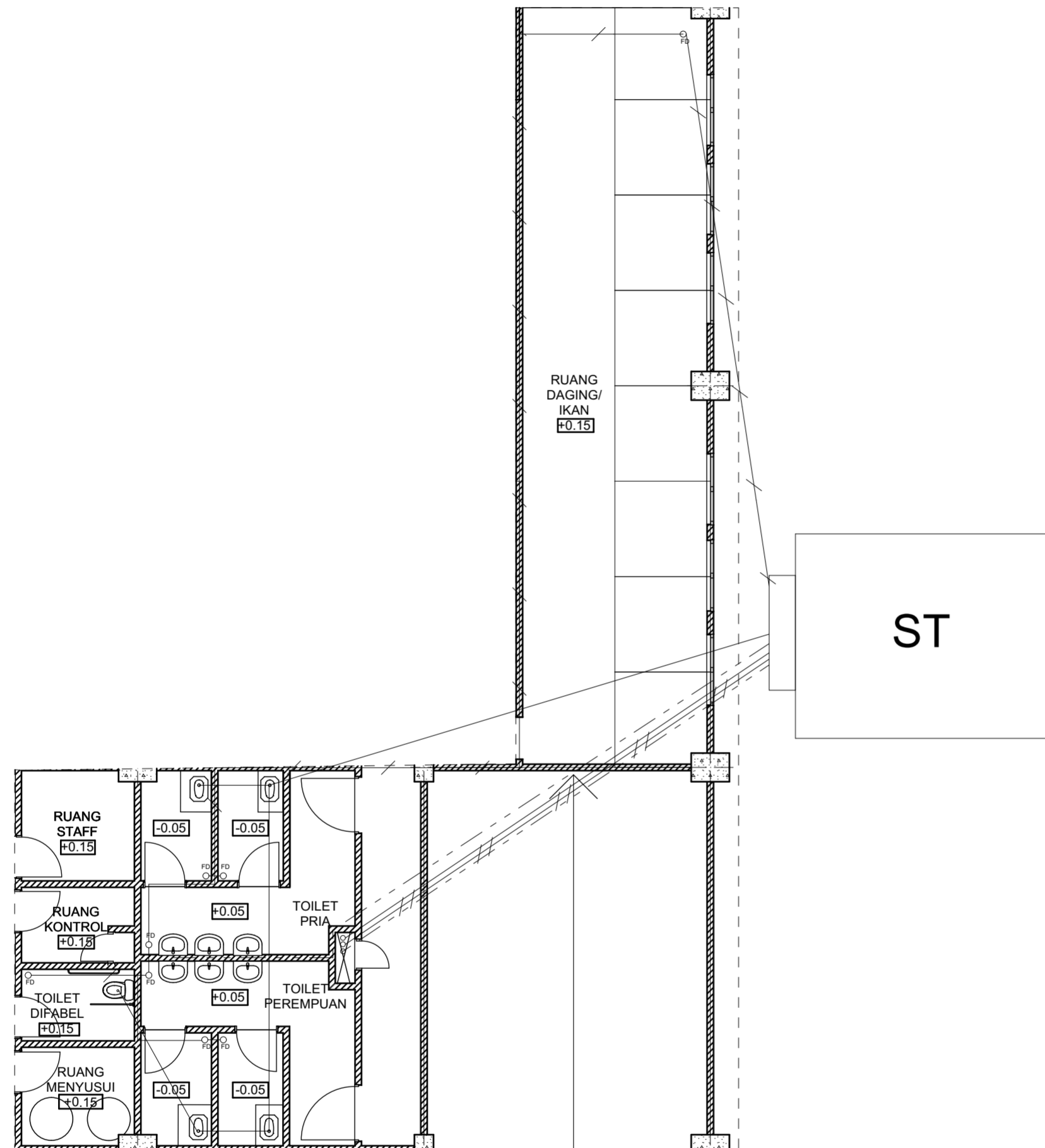

	PIPA KOTORAN CAIR 5"
	PIPA KOTORAN PADAT 5"
	PIPA AIR SABUN 5"
FD	FLOOR DRAIN
ST	SEPTICTANK

**DETAIL D**  
 SKALA 1:100

PLANNING  
CONSULTANT

PROJECT  
RE-DESIGN PASAR LEMPUYANGAN  
YOGYAKARTA

OWNER  
PT. LEMPUYANGAN

CHIEF ARCHITECT ID

HAFIAN AKBAR 14512202

TEAM NAME ID

IN HOUSE ARCHITECT

CLIENT  
Syarifah Ismailiyah A., ST., MT., IAI

DRAWING TITLE

DRAWING BY HAFIAN AKBAR

STATUS

SCALE FILE NO.

NAME	SIGN	DATE

DRAWN BY

CHECKED BY

REVIEWED & APPROVED BY

DRAWING NO.

DESCRIPTION

APPROVAL

△		
△		
△		
△		
△		

REV

NOTES

PAGE

TOTAL

INSTITUTION  
Departement of Architecture  
UNIVERSITAS ISLAM INDONESIA



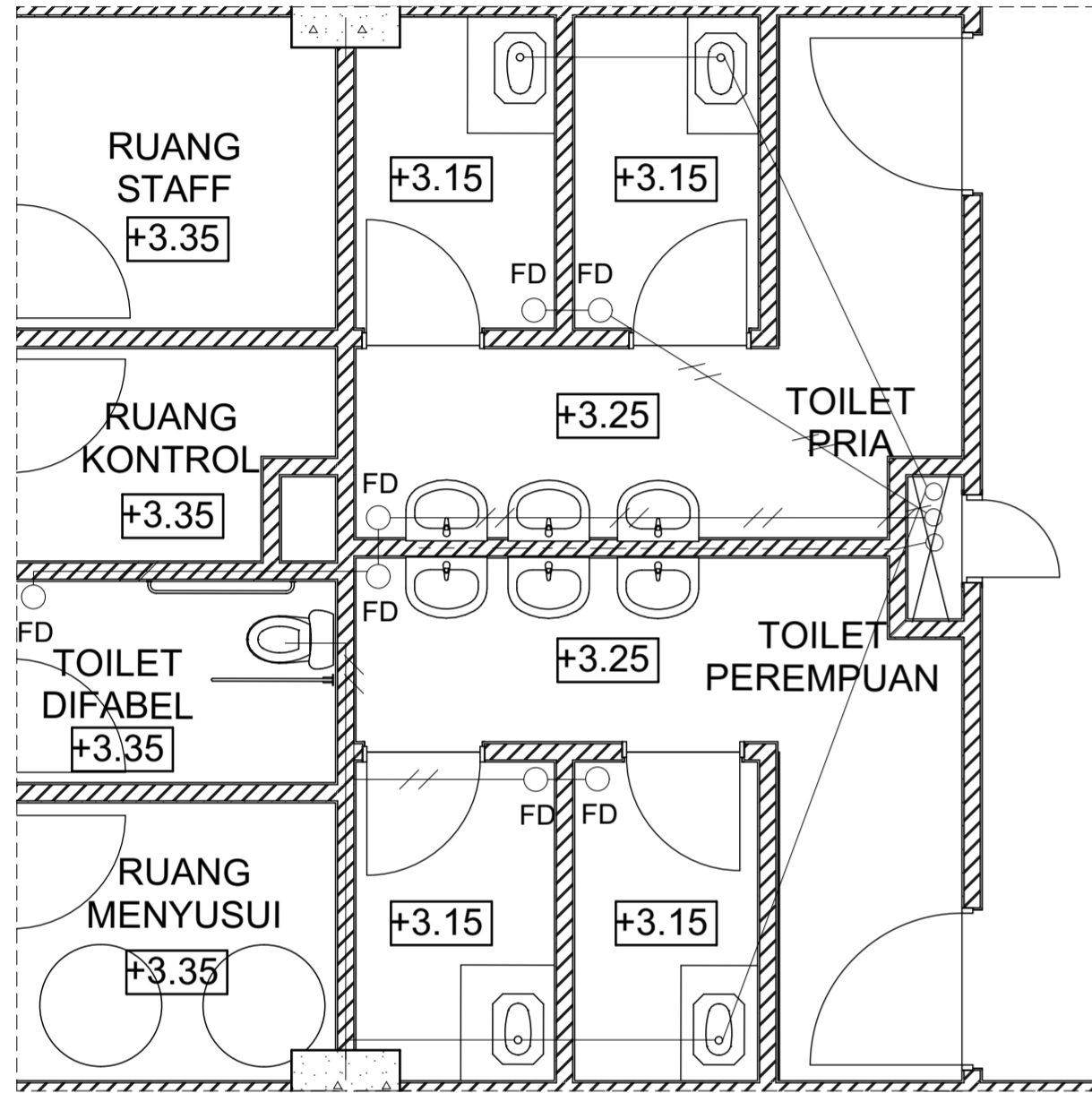

——→	PIPA KOTORAN CAIR 4" TIPE AW
——/——→	PIPA KOTORAN PADAT 4" TIPE AW
-----→	PIPA AIR SABUN 4" TIPE AW
FD	FLOOR DRAIN

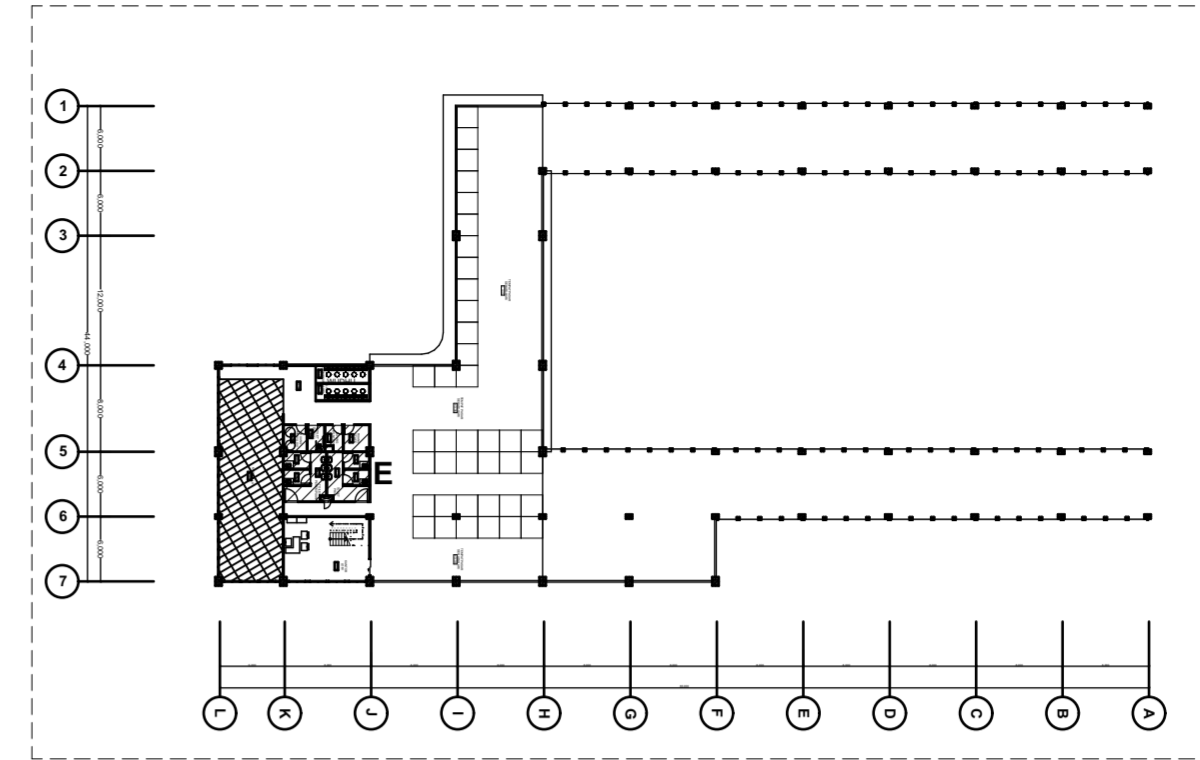

**DETAIL E**  
 SKALA 1:40

<b>PLANNING CONSULTANT</b>		
PROJECT		
RE-DESIGN PASAR LEMPUYANGAN YOGYAKARTA		
OWNER		
PT. LEMPUYANGAN		
CHIEF ARCHITECT	ID	
HAFIAN AKBAR	14512202	
TEAM NAME	ID	
IN HOUSE ARCHITECT		
CLIENT		
Syarifah Ismailiyah A., ST., MT., IAI		
DRAWING TITLE		
DRAWING BY HAFIAN AKBAR		
STATUS		
SCALE	FILE NO.	
	NAME	SIGN
		DATE
DRAWN BY		
CHECKED BY		
REVIEWED & APPROVED BY		
DRAWING NO.		
DESCRIPTION		
APPROVAL		
△		
△		
△		
△		
△		
REV		
NOTES		
PAGE	TOTAL	
INSTITUTION		
Departement of Architecture		
UNIVERSITAS ISLAM INDONESIA		

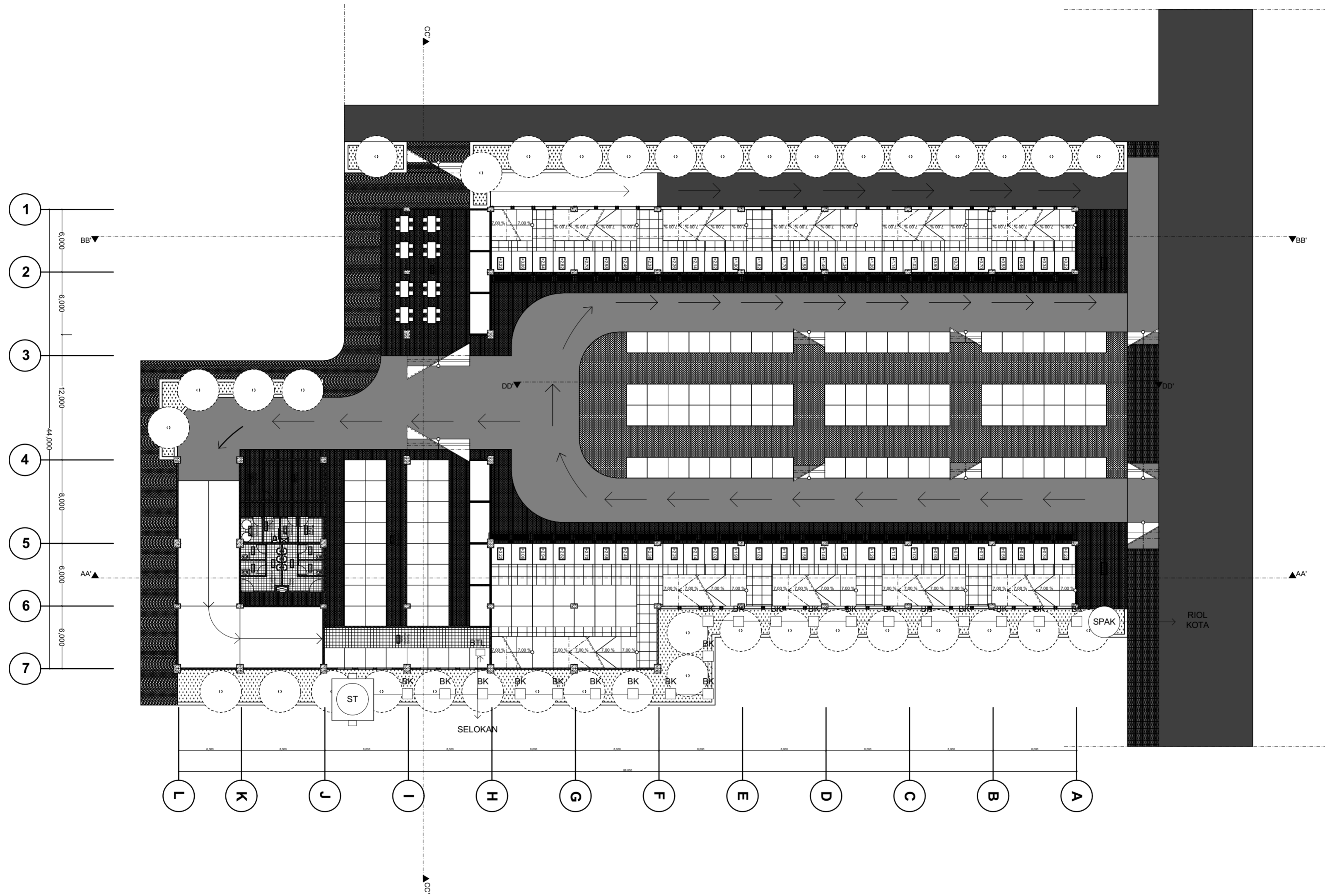

PLANNING  
CONSULTANT

PROJECT

RE-DESIGN PASAR LEMPUYANGAN  
YOGYAKARTA

OWNER

PT. LEMPUYANGAN

CHIEF ARCHITECT	ID
-----------------	----

HAFIAN AKBAR	14512202
--------------	----------

TEAM NAME	ID
-----------	----

IN HOUSE ARCHITECT

CLIENT

Syarifah Ismailiyah A., ST., MT., IAI

DRAWING TITLE

DRAWING BY HAFIAN AKBAR

STATUS

SCALE	FILE NO.
-------	----------

NAME	SIGN	DATE
------	------	------





DRAWN BY

CHECKED BY

REVIEWED & APPROVED BY

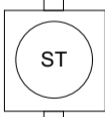
DRAWING NO.

DESCRIPTION

-  SEPTIC TANK
-  SUMUR PERESAPAN AIR KOTOR d=1,5m
-  BAK KONTROL 50x50 cm
-  BAK TANGKAP LEMAK 428 x 328 cm

APPROVAL

△		
△		
△		
△		
△		
REV		

NOTES

PAGE	TOTAL
------	-------

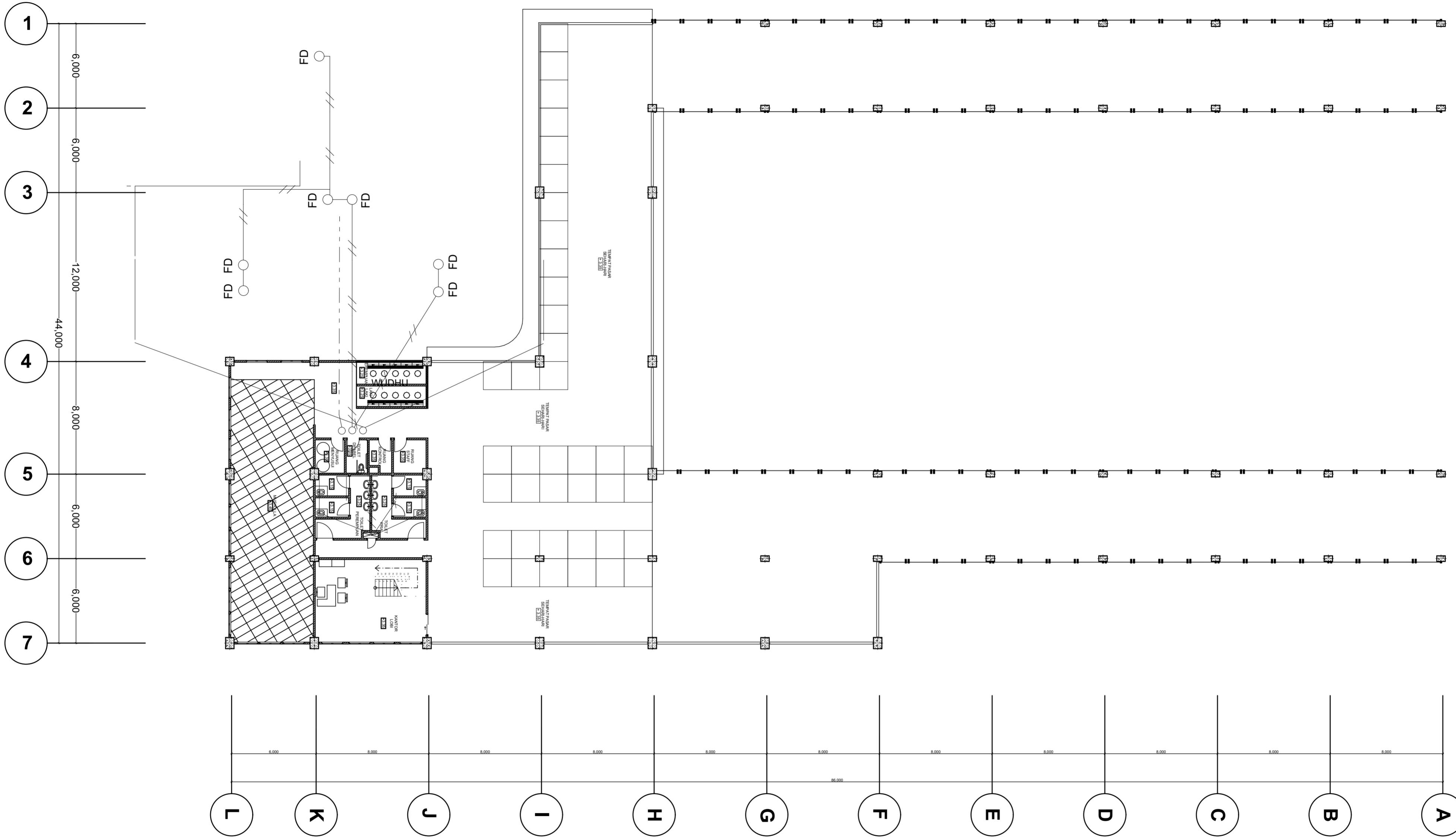

PLANNING CONSULTANT		
PROJECT		
RE-DESIGN PASAR LEMPUYANGAN YOGYAKARTA		
OWNER		
PT. LEMPUYANGAN		
CHIEF ARCHITECT	ID	
HAFIAN AKBAR	14512202	
TEAM NAME	ID	
IN HOUSE ARCHITECT		
CLIENT		
Syarifah Ismailiyah A., ST., MT., IAI		
DRAWING TITLE		
DRAWING BY HAFIAN AKBAR		
STATUS		
SCALE	FILE NO.	
	NAME	SIGN
		DATE
DRAWN BY		
CHECKED BY		
REVIEWED & APPROVED BY		
DRAWING NO.		
DESCRIPTION		
→	PIPA KOTORAN PADAT 4"	
↗	PIPA KOTORAN CAIR 4"	
- - -	PIPA AIR SABUN 4"	
APPROVAL		
△		
△		
△		
△		
△		
REV		
NOTES		
PAGE	TOTAL	
INSTITUTION		
Departement of Architecture UNIVERSITAS ISLAM INDONESIA		

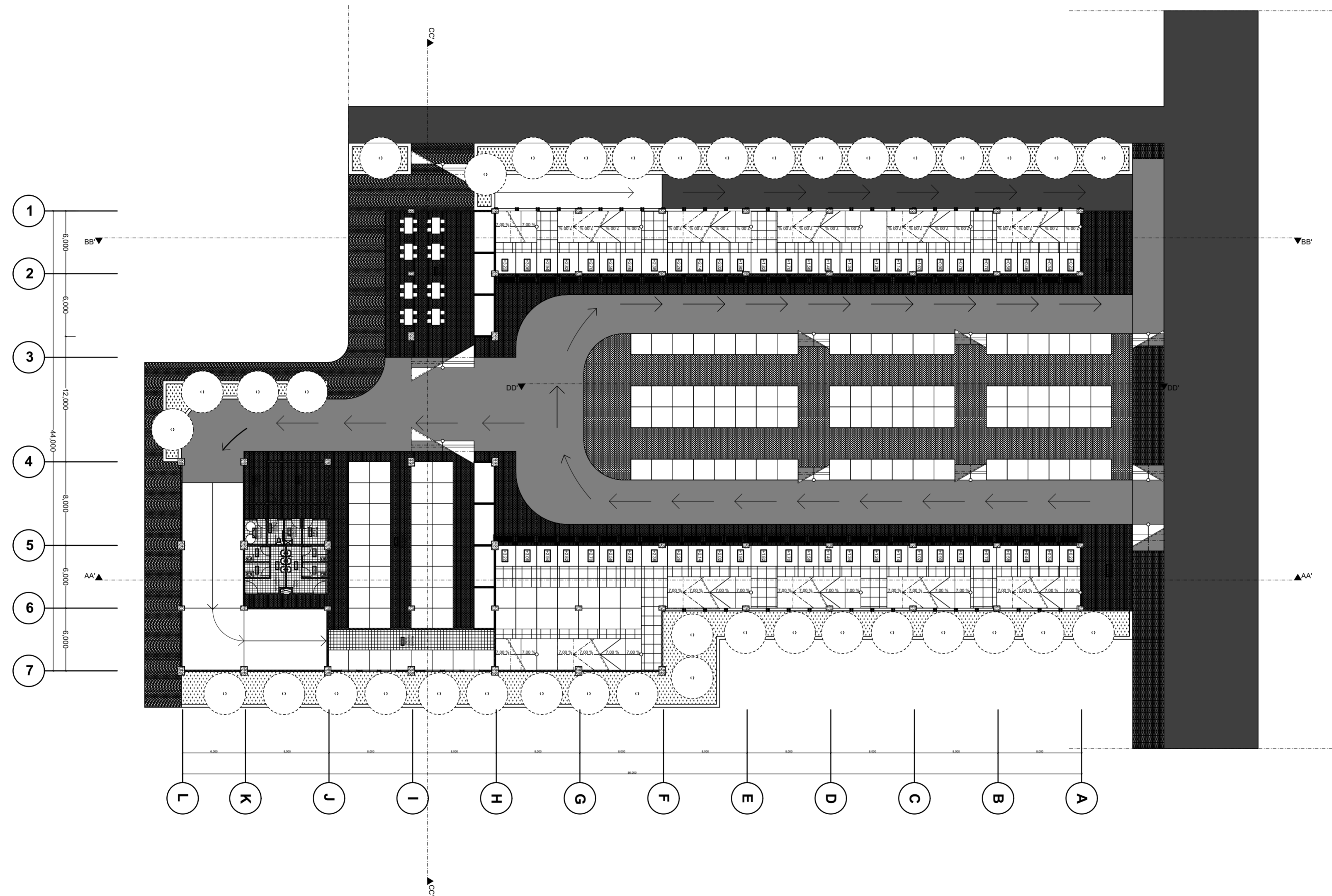

PLANNING CONSULTANT	
PROJECT	
RE-DESIGN PASAR LEMPUYANGAN YOGYAKARTA	
OWNER	
PT. LEMPUYANGAN	
CHIEF ARCHITECT	ID
HAFIAN AKBAR	14512202
TEAM NAME	ID
IN HOUSE ARCHITECT	
CLIENT	
Syarifah Ismailiyah A., ST., MT., IAI	
DRAWING TITLE	
DRAWING BY HAFIAN AKBAR	
STATUS	
SCALE	FILE NO.
	NAME SIGN DATE
DRAWN BY	
CHECKED BY	
REVIEWED & APPROVED BY	
DRAWING NO.	
DESCRIPTION	
 PIPA DISTRIBUSI AIR BERSIH d= 5 cm/ 2"	
APPROVAL	
△	
△	
△	
△	
△	
REV	
NOTES	
PAGE	TOTAL
INSTITUTION	
Departement of Architecture UNIVERSITAS ISLAM INDONESIA	



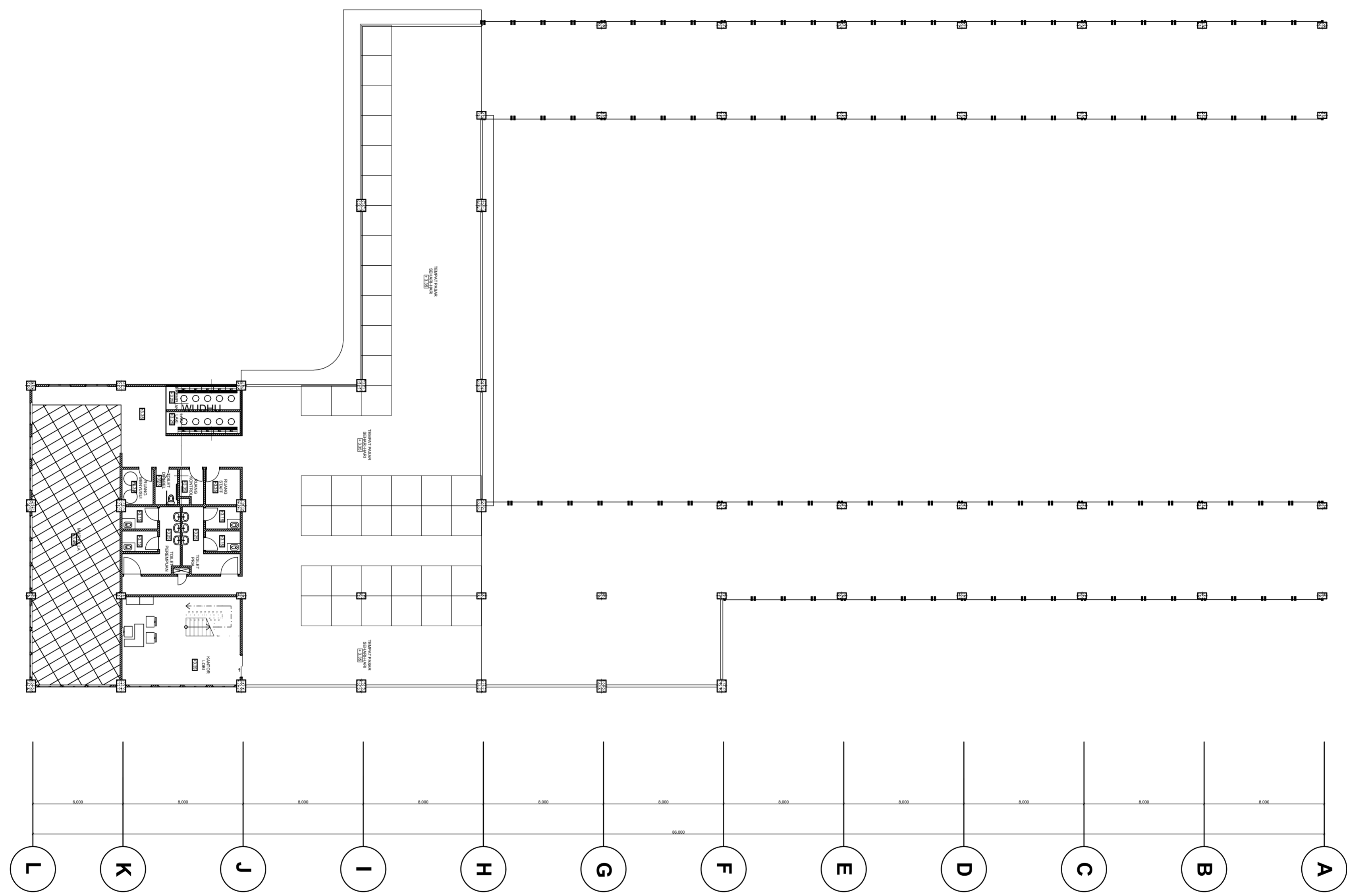
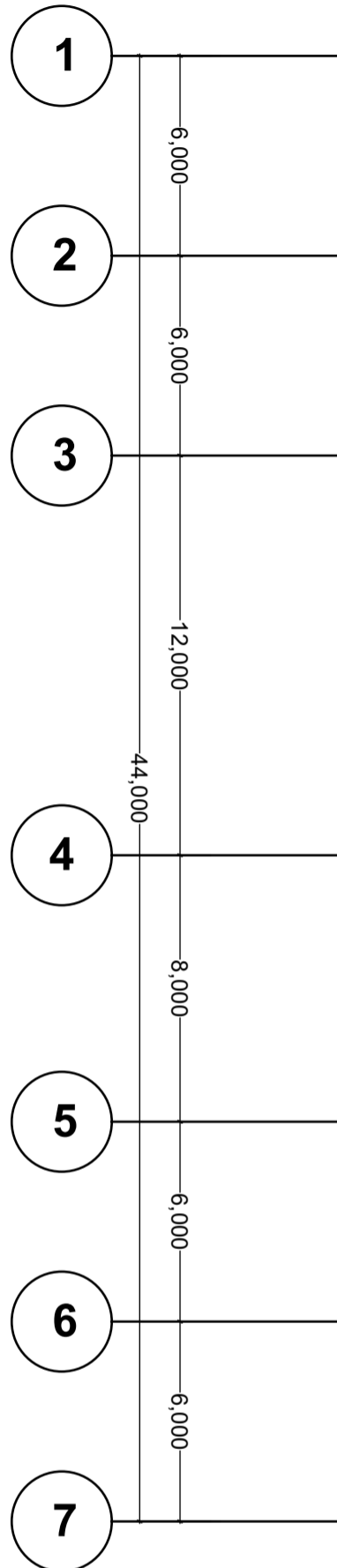

PLANNING CONSULTANT	
PROJECT	
RE-DESIGN PASAR LEMPUYANGAN YOGYAKARTA	
OWNER	
PT. LEMPUYANGAN	
CHIEF ARCHITECT	ID
HAFIAN AKBAR	14512202
TEAM NAME	ID
IN HOUSE ARCHITECT	
CLIENT	
Syarifah Ismailiyah A., ST., MT., IAI	
DRAWING TITLE	
DRAWING BY HAFIAN AKBAR	
STATUS	
SCALE	FILE NO.
	NAME SIGN DATE
DRAWN BY	
CHECKED BY	
REVIEWED & APPROVED BY	
DRAWING NO.	
DESCRIPTION	
 PIPA DISTRIBUSI AIR BERSIH d= 5 cm/ 2"	
APPROVAL	
△	
△	
△	
△	
△	
REV	
NOTES	
PAGE	TOTAL
INSTITUTION	
Departement of Architecture	
UNIVERSITAS ISLAM INDONESIA	

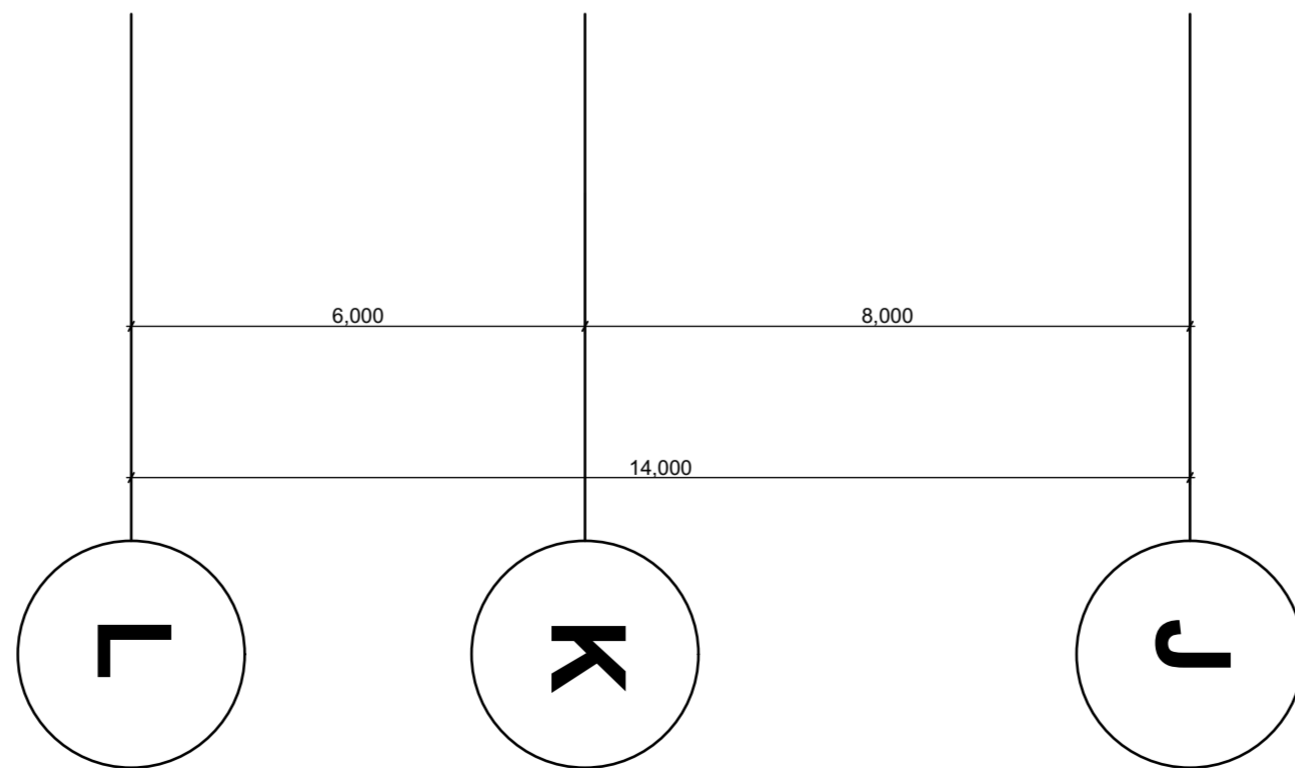
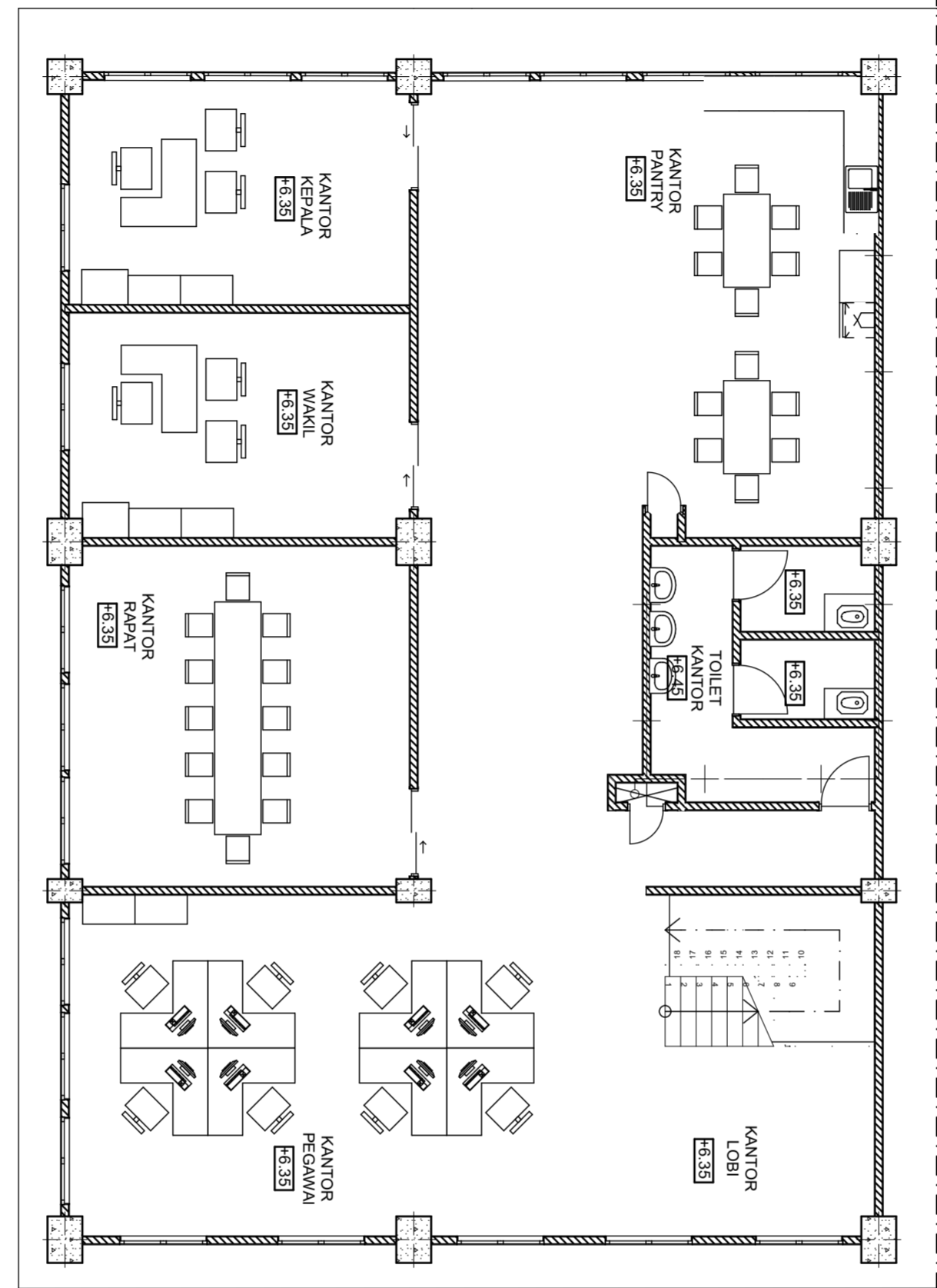
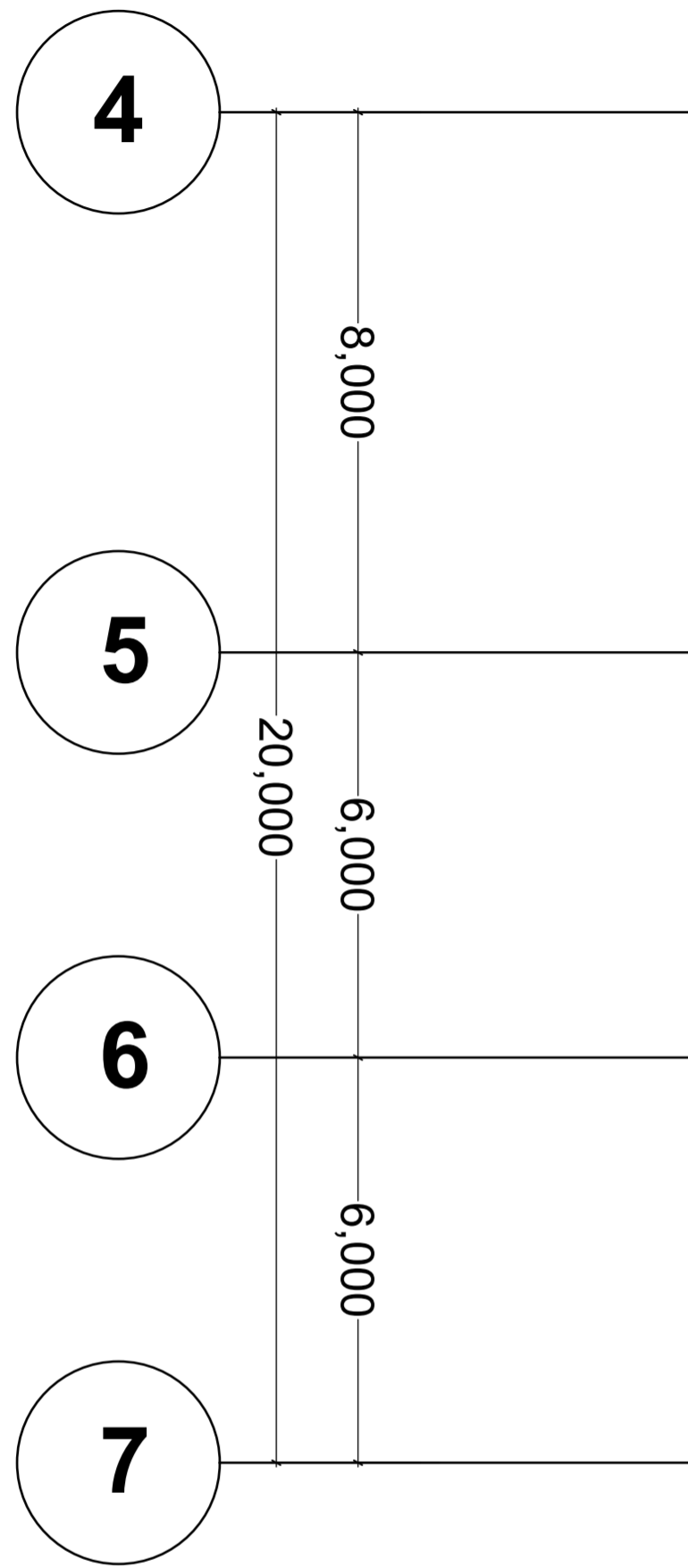

PLANNING CONSULTANT

PROJECT

RE-DESIGN PASAR LEMPUYANGAN  
YOGYAKARTA

OWNER

PT. LEMPUYANGAN

CHIEF ARCHITECT ID

HAFIAN AKBAR 14512202

TEAM NAME ID

IN HOUSE ARCHITECT

CLIENT

Syarifah Ismailiyah A., ST., MT., IAI

DRAWING TITLE

DRAWING BY HAFIAN AKBAR

STATUS

SCALE FILE NO.

NAME SIGN DATE

DRAWN BY

CHECKED BY

REVIEWED & APPROVED BY

DRAWING NO.

DESCRIPTION

PIPA DISTRIBUSI  
AIR BERSIH  
d= 5 cm/ 2"

APPROVAL

△			
△			
△			
△			
△			
REV			

NOTES

PAGE TOTAL

INSTITUTION  
Departement of Architecture  
UNIVERSITAS ISLAM INDONESIA

