

PROYEK AKHIR SARJANA

**BANDUNG CULTURE AND TOURISM CENTER**

DIBUAT OLEH :

NAMA : FREDY MAHENDRA  
 NIM : 14 512 139

PEMBIMBING : M. Galieh Gunagama, S.T., M.Sc.  
 PENGUJI : Dr. Ir. Sugini, M.T., IAI

NAMA GAMBAR : BCTC A.01

JUDUL GAMBAR : 0. Masterplan

Hlm :  
 SKALA : 1 : 1000

NO.	TANGGAL :

CATATAN / REVISI :



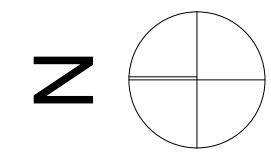
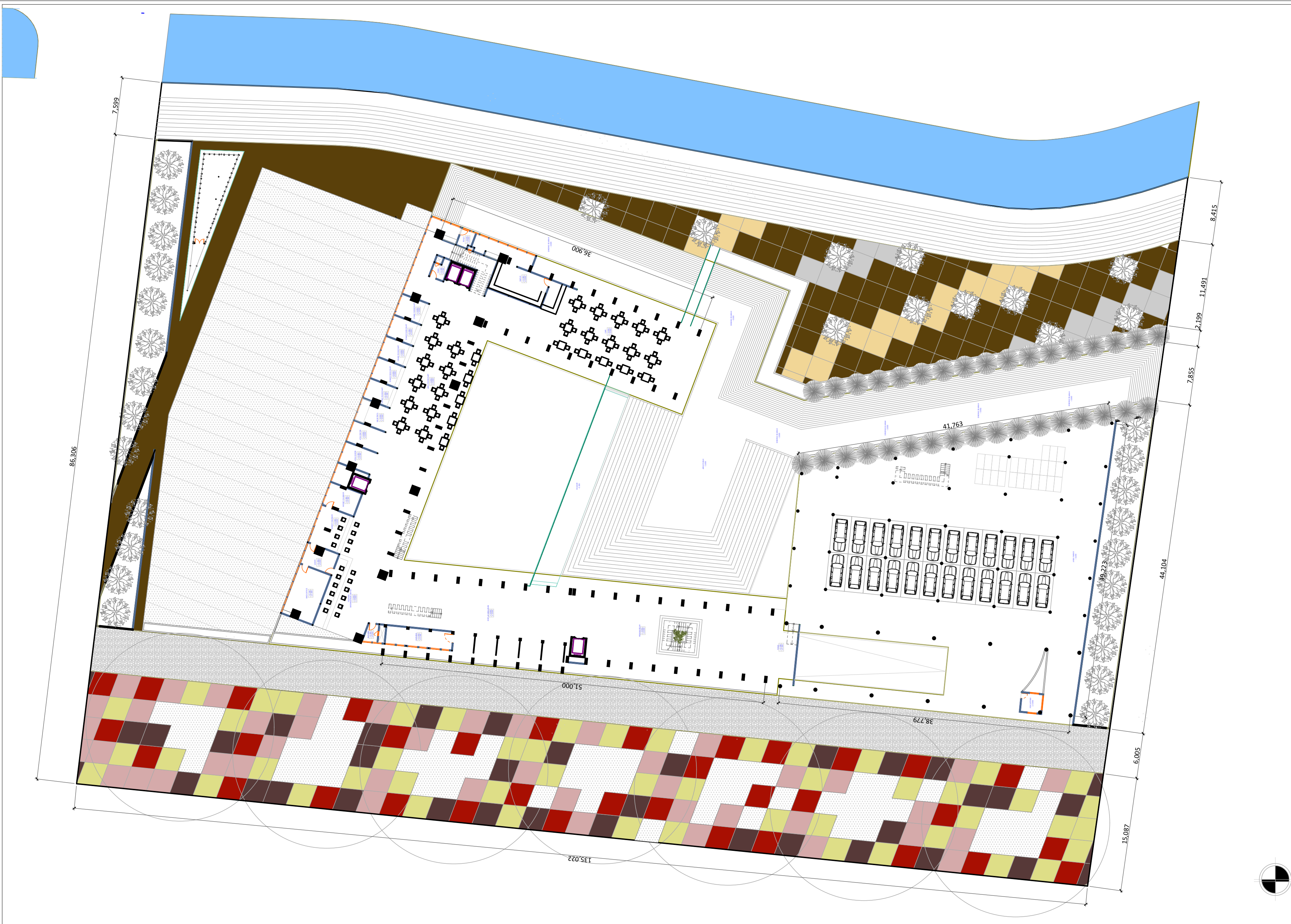

-  pohon ashoka  
34 pohon
-  pohon kelumpang  
34 pohon
-  pohon kiara payung  
7 pohon
-  pozzo alessandria brown  
60x120 mm
-  pozzo dessert dust  
60x120 mm
-  pozzo volcanic ash  
60x120 mm
-  pozzo sedona sage  
60x120 mm
-  coloured concrete  
grey
-  coloured concrete  
cream
-  coloured concrete  
brown
-  rumput kucai mini
-  area tanam  
sayuran umbi

**SITEPLAN**  
1 : 350

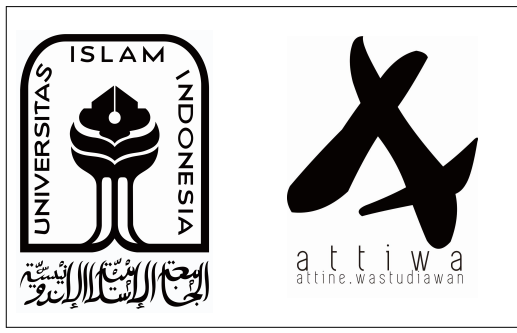

PROYEK AKHIR SARJANA  
  
BANDUNG CULTURE AND TOURISM CENTER

DIBUAT OLEH :

NAMA :	NIM :
FREDY MAHENDRA	14 512 139
PEMBIMBING :	M. Galieh Gunagama, S.T., M.Sc.
PENGUJI :	Dr. Ir. Sugini, M.T., IAI

NAMA GAMBAR :  
BCTC A.01  
JUDUL GAMBAR :  
0. Siteplan

Hlm :	DISETUJUI :	NO.	TANGGAL :
A.01			
SKALA :			
1:350			

CATATAN / REVISI :



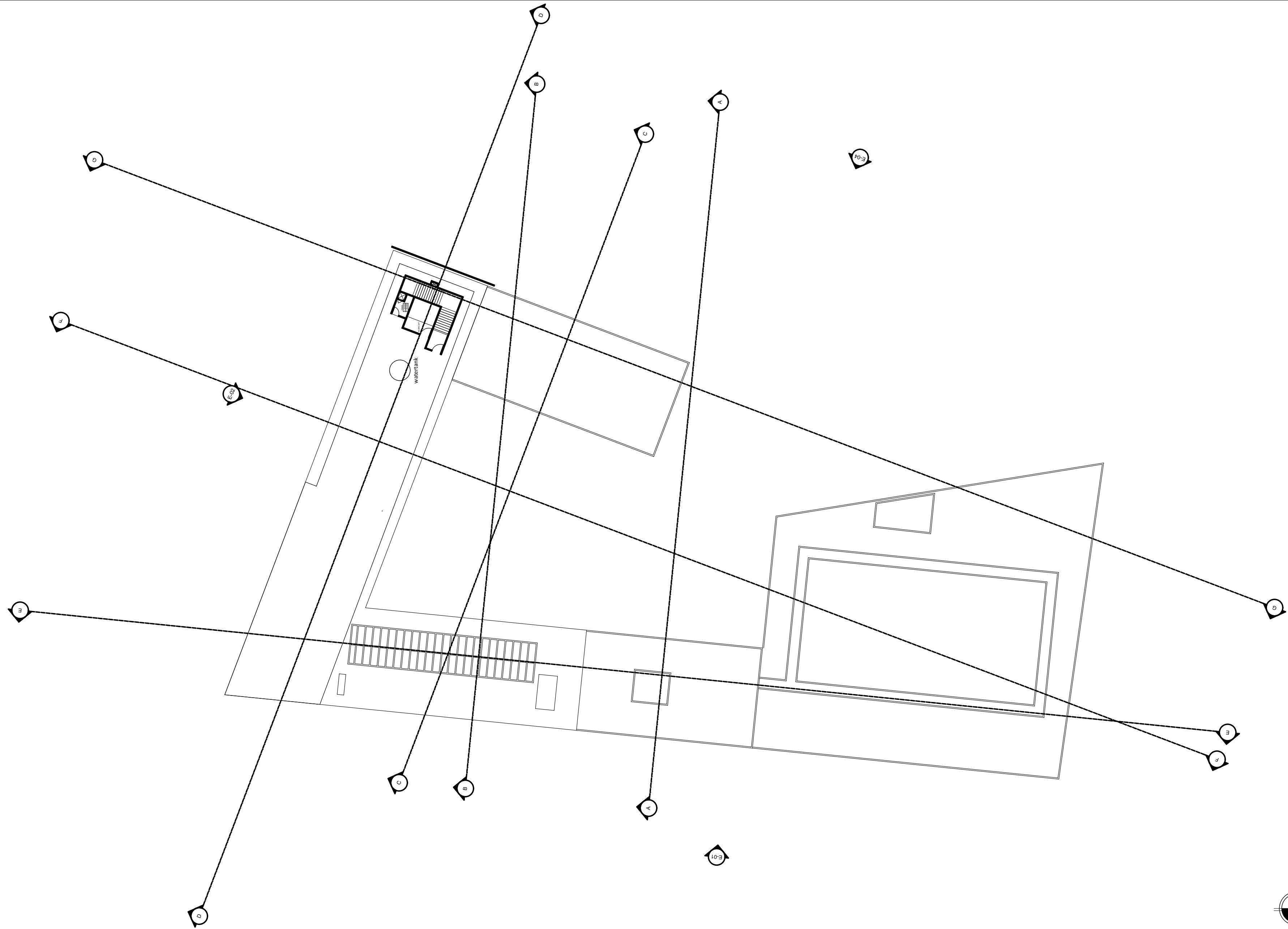
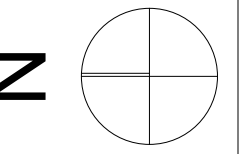

**DENAH ROOFTOP**  
1 : 350



PROYEK AKHIR SARJANA		DIBUAT OLEH :		NAMA GAMBAR :		Hlm :	DISETUJUI :	NO.	TANGGAL :	CATATAN / REVISI :	
BANDUNG CULTURE AND TOURISM CENTER		NAMA :		Plan BCTC		A.01.3					
		FREDY MAHENDRA		JUDUL GAMBAR :		SKALA :					
		PEMBIMBING :	M. Galieh Gunagama, S.T., M.Sc.		5. Story		1:350				
		PENGUJI :	Dr. Ir. Sugini, M.T., IAI								







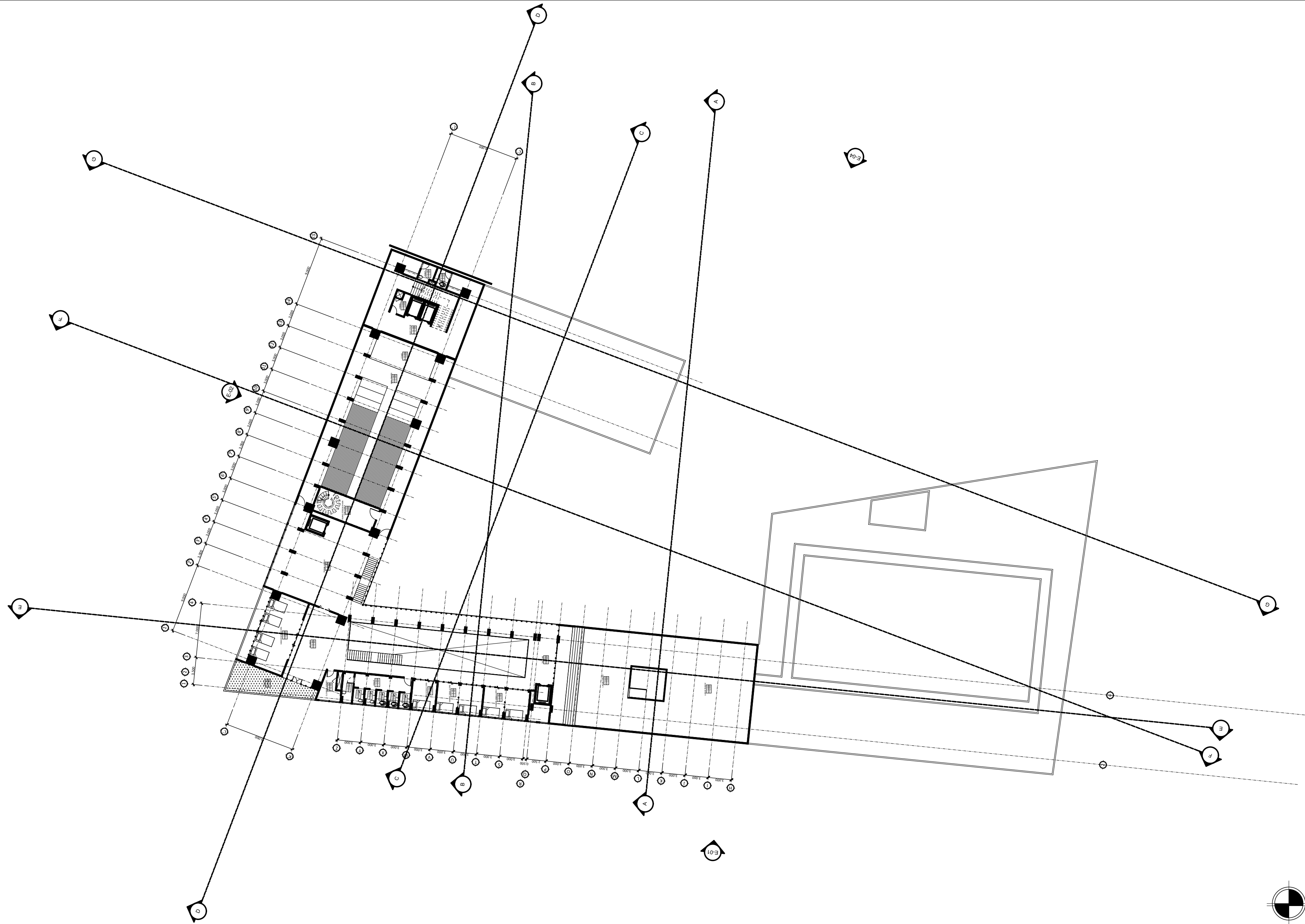
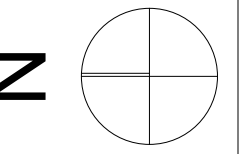

 **DENAH LANTAI 3**  
1 : 350

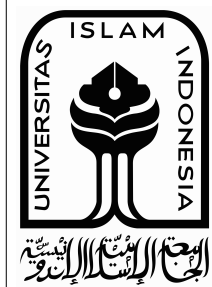

PROYEK AKHIR SARJANA		DIBUAT OLEH :		NAMA GAMBAR :		Hlm :	DISETUJUI :	NO.	TANGGAL :	CATATAN / REVISI :	
BANDUNG CULTURE AND TOURISM CENTER		NAMA :		Plan BCTC		A.01.3					
		FREDY MAHENDRA		JUDUL GAMBAR :		SKALA :					
		PEMBIMBING :	M. Galieh Gunagama, S.T., M.Sc.		3. Story						1:350
		PENGUJI :	Dr. Ir. Sugini, M.T., IAI								



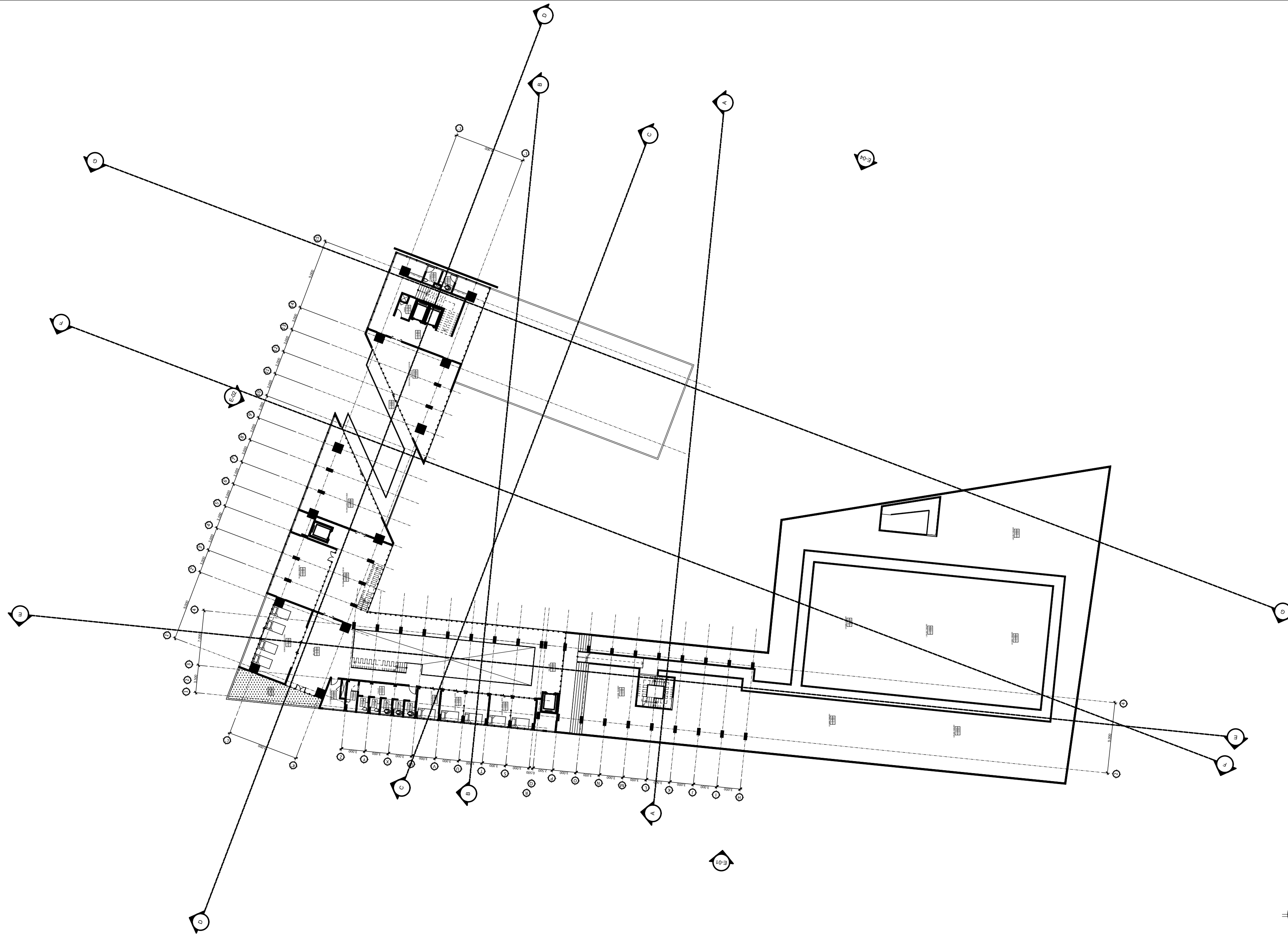
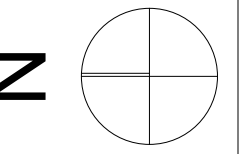

 **DENAH LANTAI 2**  
1 : 350

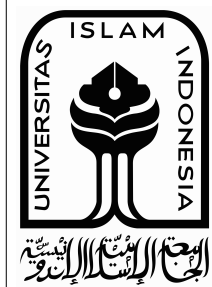

PROYEK AKHIR SARJANA		DIBUAT OLEH :		NAMA GAMBAR :		Hlm :	DISETUJUI :	NO.	TANGGAL :	CATATAN / REVISI :	
BANDUNG CULTURE AND TOURISM CENTER		NAMA :		Plan BCTC		A.01.3					
		FREDY MAHENDRA		JUDUL GAMBAR :		SKALA :					
		PEMBIMBING :	M. Galieh Gunagama, S.T., M.Sc.		2. Story						1:350
		PENGUJI :	Dr. Ir. Sugini, M.T., IAI								







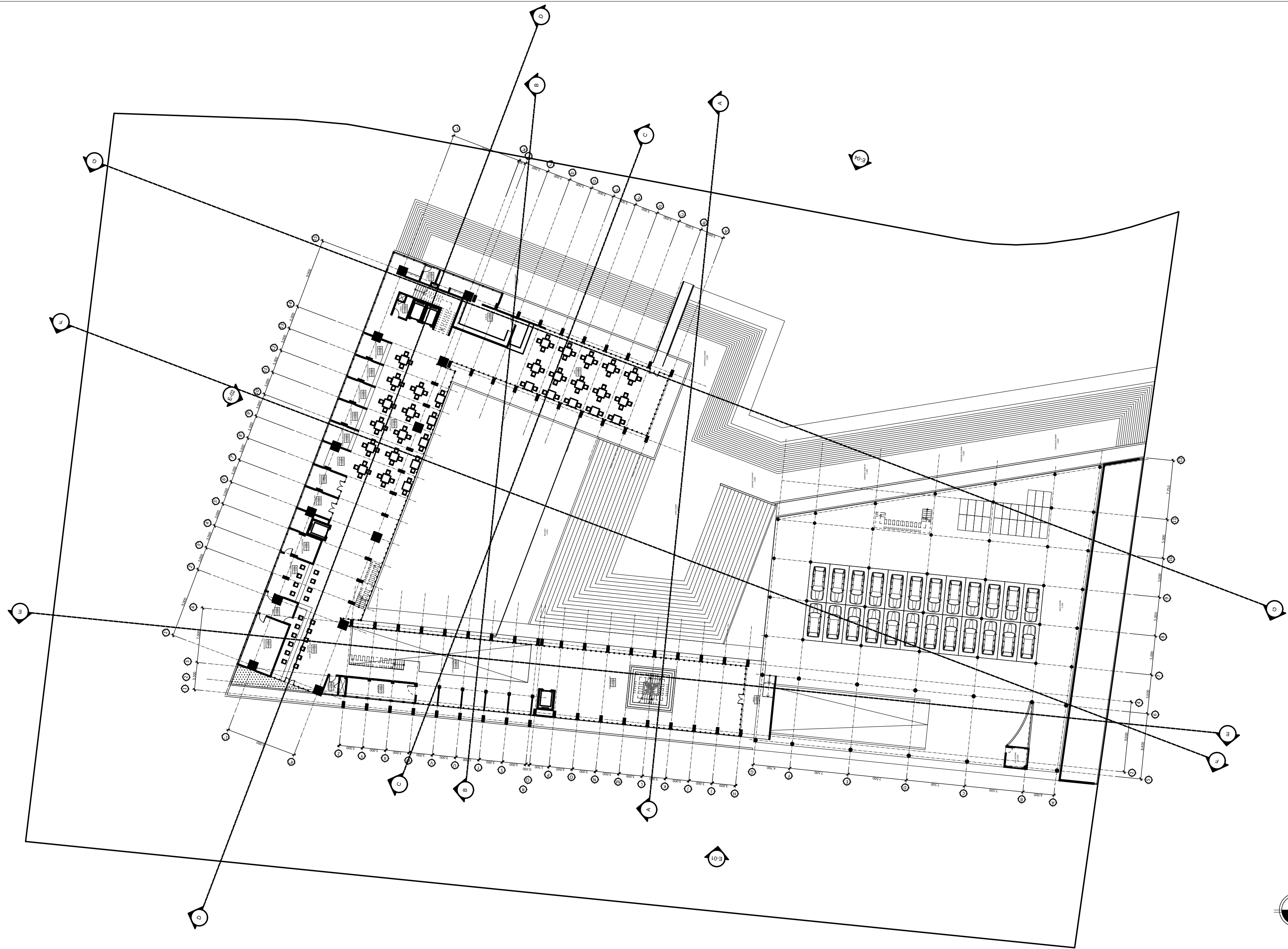
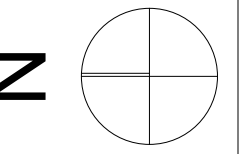

**DENAH LANTAI DASAR**  
1 : 350

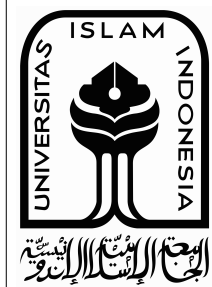

PROYEK AKHIR SARJANA  BANDUNG CULTURE AND TOURISM CENTER	DIBUAT OLEH :		NAMA GAMBAR :	Hlm :	DISETUJUI :	NO.	TANGGAL :	CATATAN / REVISI :
	NAMA :	NIM :	Plan BCTC	A.01.3				
	FREDY MAHENDRA	14 512 139	JUDUL GAMBAR :	SKALA :				
	PEMBIMBING :	M. Galieh Gunagama, S.T., M.Sc.	0. Ground Floor	1:350				
	PENGUJI :	Dr. Ir. Sugini, M.T., IAI						



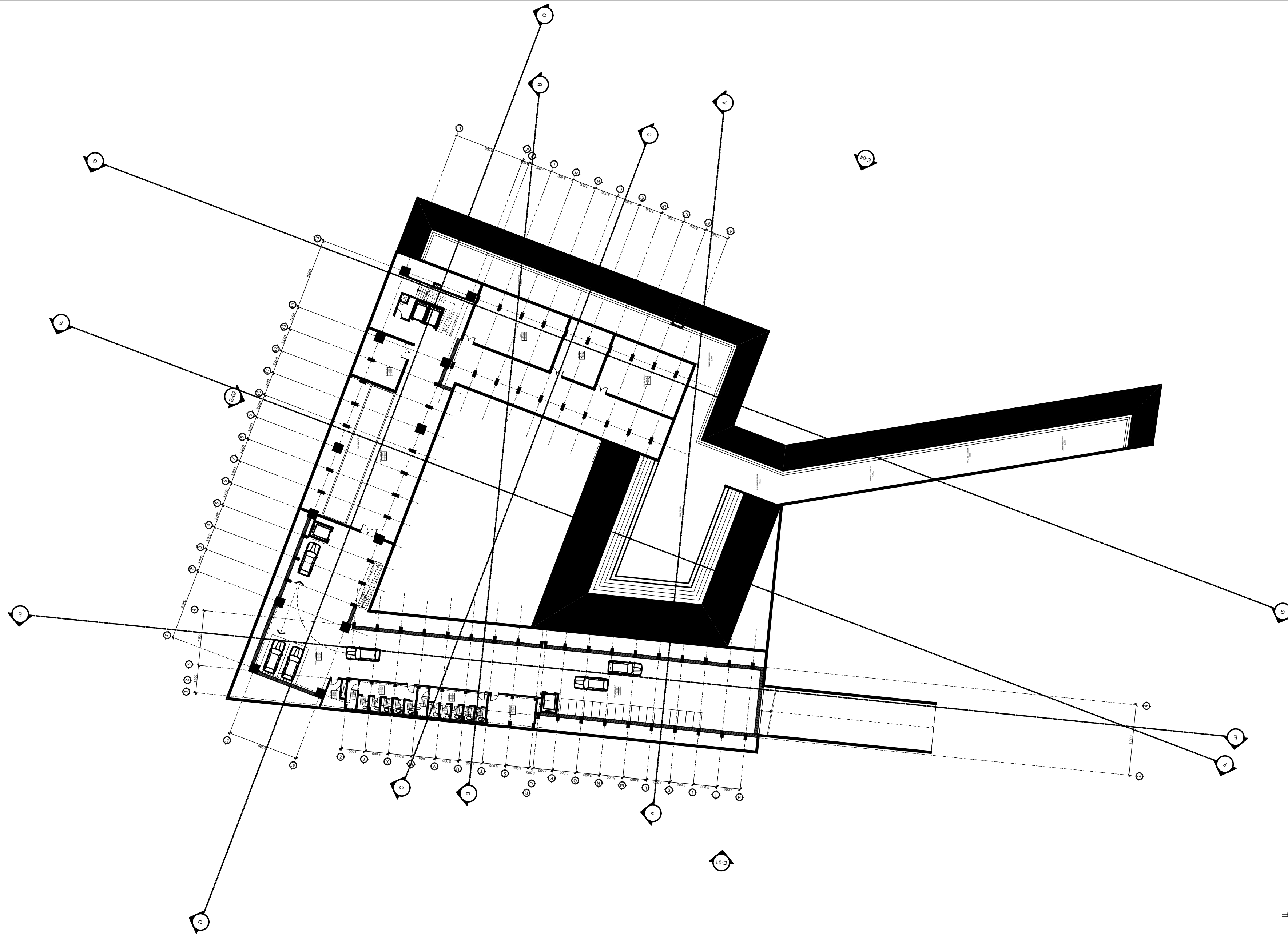
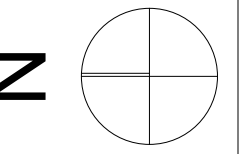

**DENAH BASEMENT**  
1 : 350

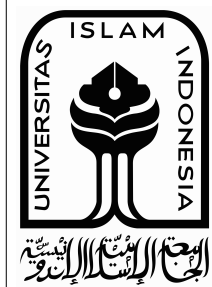

PROYEK AKHIR SARJANA  <b>BANDUNG CULTURE AND TOURISM CENTER</b>	DIBUAT OLEH :		NAMA GAMBAR :	Hlm :	DISETUJUI :	NO.	TANGGAL :	CATATAN / REVISI :
	NAMA :	NIM :	Plan BCTC	A.01.3				
	FREDY MAHENDRA	14 512 139	JUDUL GAMBAR :	SKALA :				
	PEMBIMBING :	M. Galieh Gunagama, S.T., M.Sc.	-1. Story	1:350				
	PENGUJI :	Dr. Ir. Sugini, M.T., IAI						



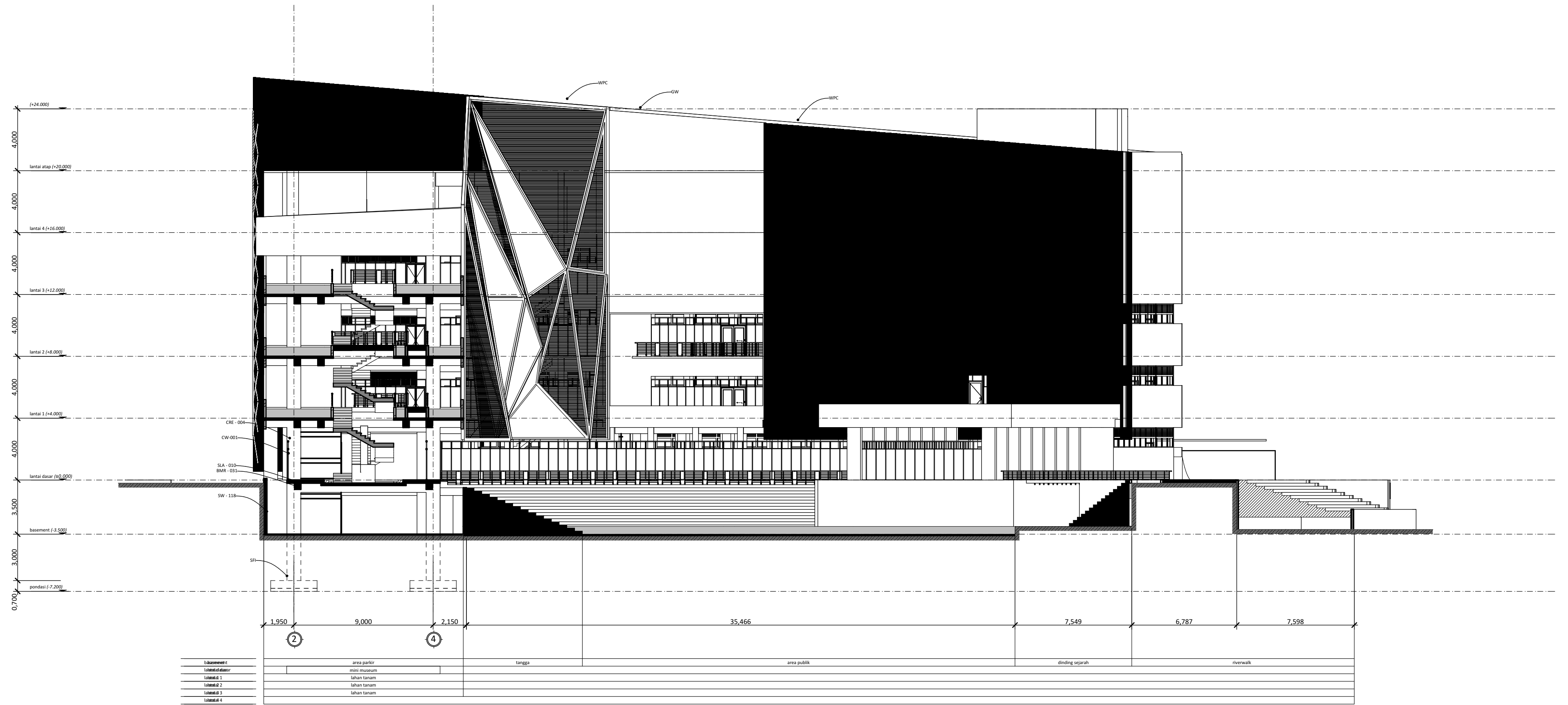

- BMR - 031 : balok beton 400x900 mm
- BMR - 041 : balok beton 1200x1200 mm
- CRE - 004 : kolom beton
- CW - 001 : curtain wall
- GW : green wall facade
- SF : pondasi footplat 1900x2400 mm
- SF 2 : pondasi bored pile dia. 2000 mm
- SLA - 010 : plat lantai beton 120 mm
- SW - 126 : dinding pemikul 200 mm
- SW - 148 : dinding bata ringan
- WPC : wood plastic composite

**POTONGAN A-A**  
 1 : 200

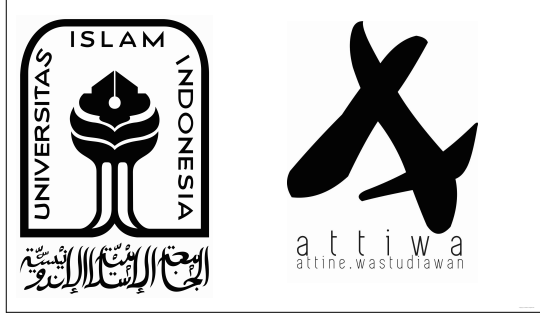

PROYEK AKHIR SARJANA  <b>BANDUNG CULTURE AND TOURISM CENTER</b>	DIBUAT OLEH :  NAMA : FREDY MAHENDRA NIM : 14 512 139  PEMBIMBING : M. Galieh Gunagama, S.T., M.Sc. PENGUJI : Dr. Ir. Sugini, M.T., IAI	NAMA GAMBAR : Section BCTC  JUDUL GAMBAR : A Building Section	Hlm : A.01.4  SKALA : 1:200	DISETUJUI :  NO. :  TANGGAL :	CATATAN / REVISI :
---	---	---	-----------------------------------	---	--------------------

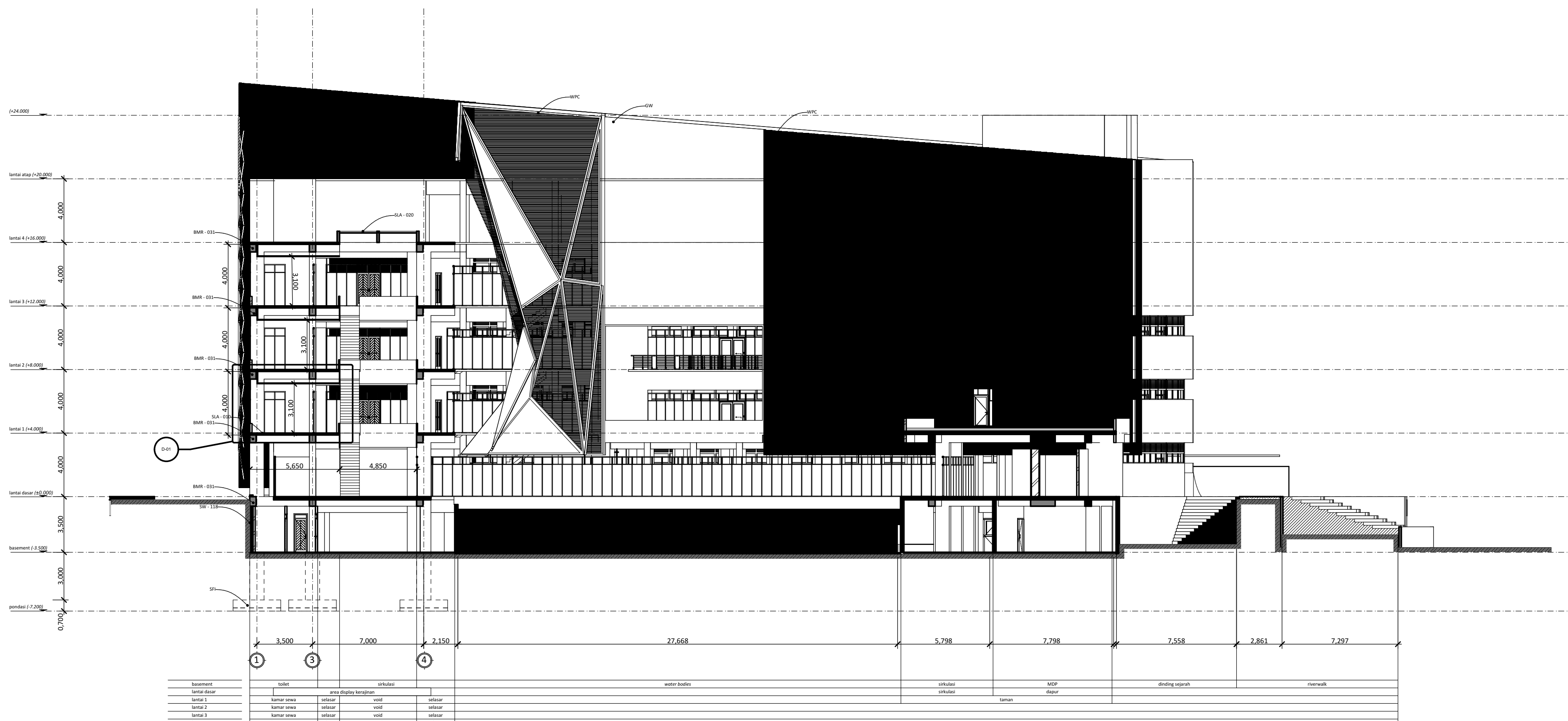

- BMR - 031 : balok beton 400x900 mm
- BMR - 041 : balok beton 1200x1200 mm
- CRE - 004 : kolom beton
- CW - 001 : curtain wall
- GW : green wall facade
- SF : pondasi footplat 1900x2400 mm
- SF 2 : pondasi bored pile dia. 2000 mm
- SLA - 010 : plat lantai beton 120 mm
- SW - 126 : dinding pemikul 200 mm
- SW - 148 : dinding bata ringan
- WPC : wood plastic composite

**POTONGAN B-B**  
 1 : 200



PROYEK AKHIR SARJANA  <b>BANDUNG CULTURE AND TOURISM CENTER</b>	DIBUAT OLEH :  NAMA : FREDY MAHENDRA NIM : 14 512 139  PEMBIMBING : M. Galieh Gunagama, S.T., M.Sc. PENGUJI : Dr. Ir. Sugini, M.T., IAI	NAMA GAMBAR : Section BCTC Hlm : A.01.4  JUDUL GAMBAR : B Building Section SKALA : 1:200	DISETUJUI :  NO. :  TANGGAL :	CATATAN / REVISI :
---	---	--	---	--------------------



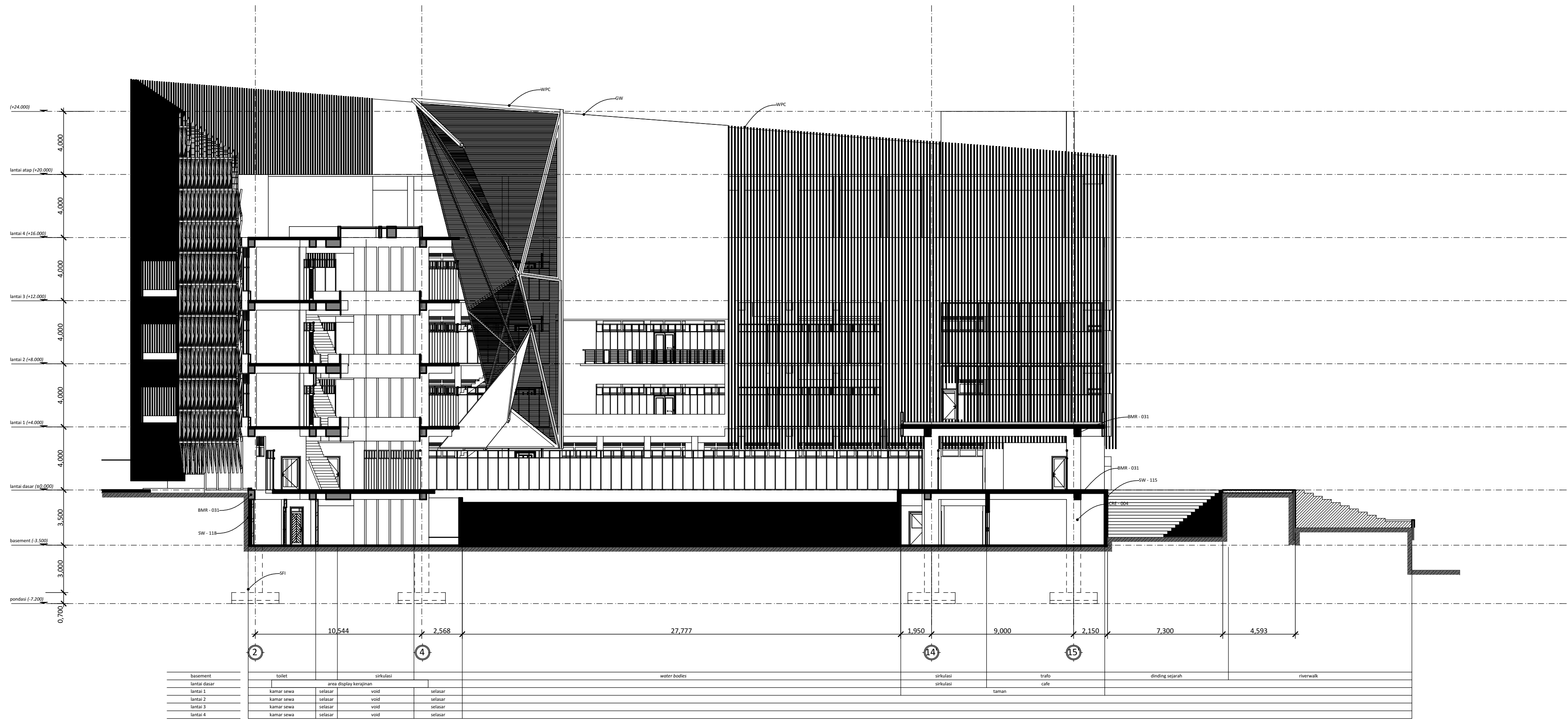

- BMR - 031 : balok beton 400x900 mm
- BMR - 041 : balok beton 1200x1200 mm
- CRE - 004 : kolom beton
- CW - 001 : curtain wall
- GW : green wall facade
- SF : pondasi footplat 1900x2400 mm
- SF 2 : pondasi bored pile dia. 2000 mm
- SLA - 010 : plat lantai beton 120 mm
- SW - 126 : dinding pemikul 200 mm
- SW - 148 : dinding bata ringan
- WPC : wood plastic composite

**POTONGAN C-C**  
 1 : 200



PROYEK AKHIR SARJANA  
**BANDUNG CULTURE AND TOURISM CENTER**

DIBUAT OLEH :  
 NAMA : FREDY MAHENDRA      NIM : 14 512 139  
 PEMBIMBING : M. Galieh Gunagama, S.T., M.Sc.  
 PENGUJI : Dr. Ir. Sugini, M.T., IAI

NAMA GAMBAR : Section BCTC  
 Hlm : A.01.4  
 JUDUL GAMBAR : C Building Section  
 SKALA : 1:200

DISETUJUI :	NO.	TANGGAL :	CATATAN / REVISI :





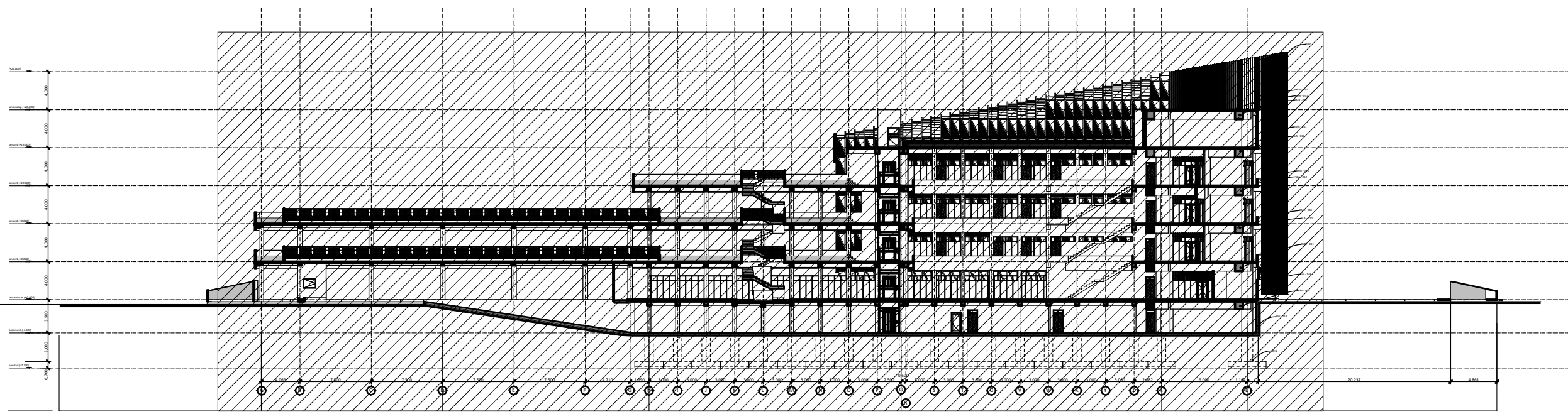
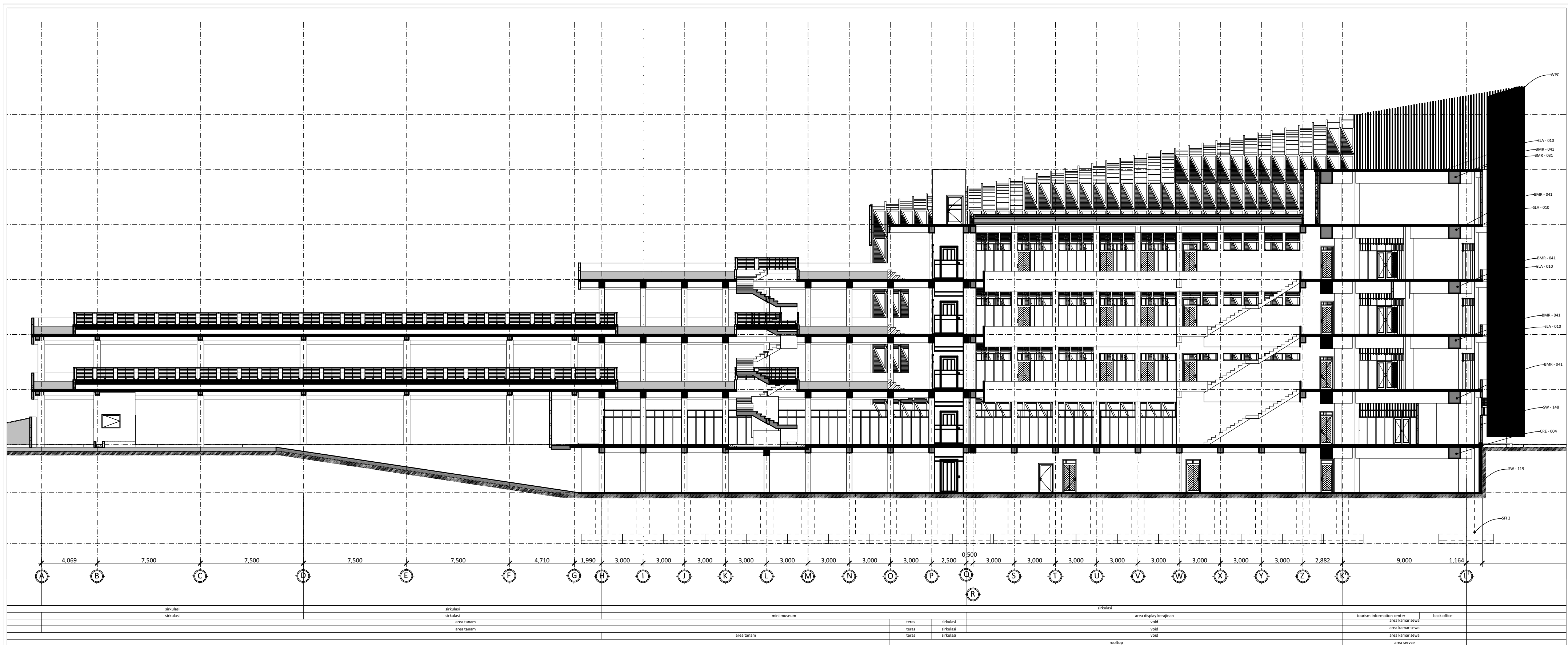

**POTONGAN E-E**  
1 : 500

**POTONGAN E-E**  
1 : 200

- BMR - 031 : balok beton 400x900 mm
- BMR - 041 : balok beton 1200x1200 mm
- CRE - 004 : kolom beton
- CW - 001 : curtain wall
- GW : green wall facade
- SF : pondasi footplat 1900x2400 mm
- SF 2 : pondasi bored pile dia. 2000 mm
- SLA - 010 : plat lantai beton 120 mm
- SW - 126 : dinding pemikul 200 mm
- SW - 148 : dinding bata ringan
- WPC : wood plastic composite

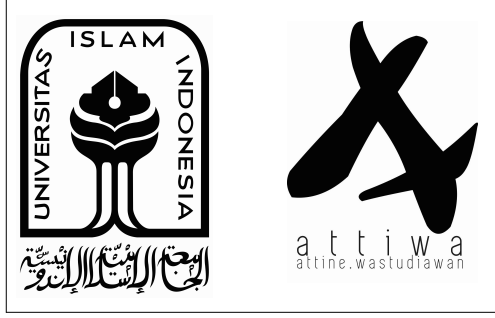

PROYEK AKHIR SARJANA	DIBUAT OLEH :		NAMA GAMBAR :	Hlm :	DISETUJUI :	NO.	TANGGAL :	CATATAN / REVISI :
BANDUNG CULTURE AND TOURISM CENTER	NAMA :	NIM :	Section BCTC	A.01.4				
	FREDY MAHENDRA	14 512 139	JUDUL GAMBAR :	SKALA :				
	PEMBIMBING :	M. Galieh Gunagama, S.T., M.Sc.	E Building Section	1:200, 1:500				
	PENGUJI :	Dr. Ir. Sugini, M.T., IAI						

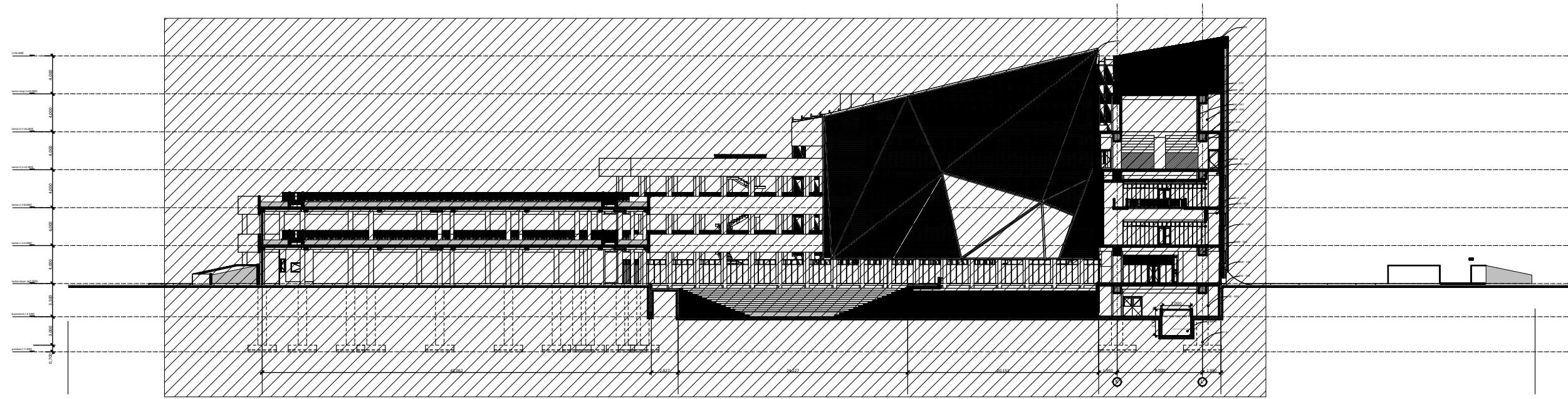
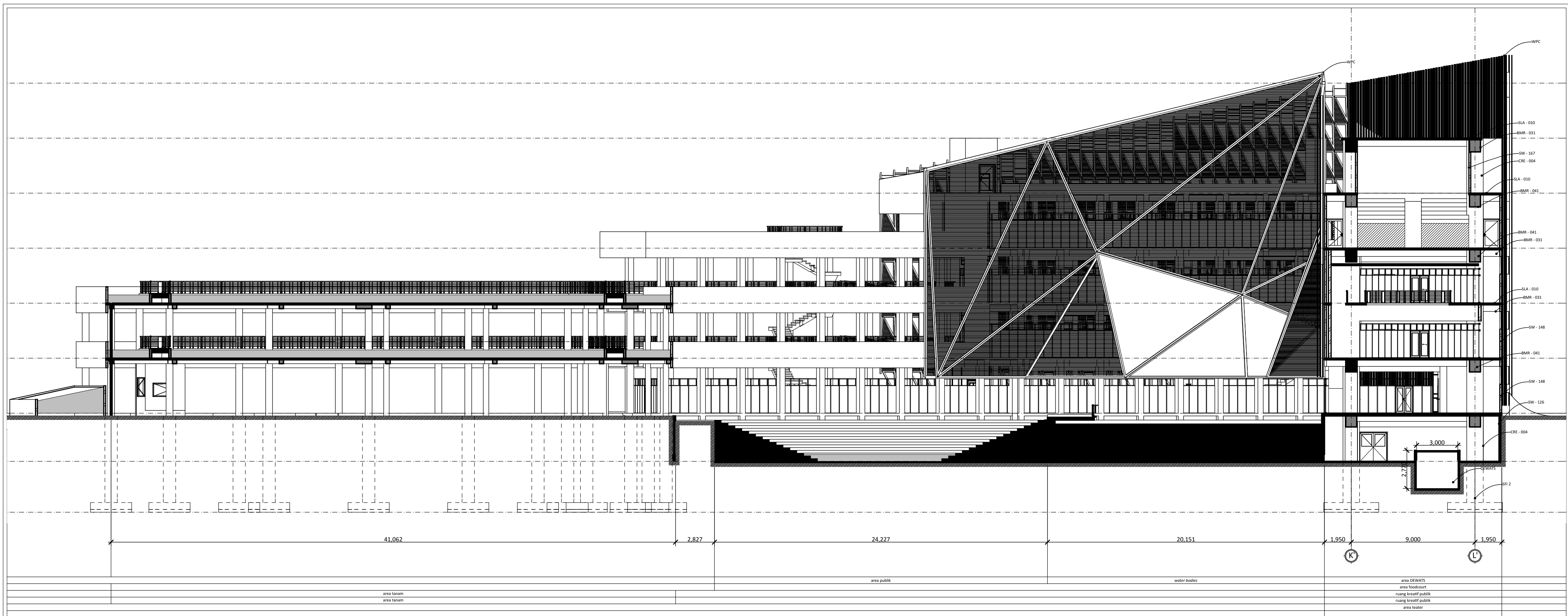

- BMR - 031 : balok beton 400x900 mm
- BMR - 041 : balok beton 1200x1200 mm
- CRE - 004 : kolom beton
- CW - 001 : curtain wall
- GW : green wall facade
- SF : pondasi footplat 1900x2400 mm
- SF 2 : pondasi bored pile dia. 2000 mm
- SLA - 010 : plat lantai beton 120 mm
- SW - 126 : dinding pemikul 200 mm
- SW - 148 : dinding bata ringan
- WPC : wood plastic composite

**POTONGAN F-F**  
1 : 500

**POTONGAN F-F**  
1 : 200



PROYEK AKHIR SARJANA  
**BANDUNG CULTURE AND TOURISM CENTER**

DIBUAT OLEH :  
NAMA : FREDY MAHENDRA  
NIM : 14 512 139  
PEMBIMBING : M. Galieh Gunagama, S.T., M.Sc.  
PENGUJI : Dr. Ir. Sugini, M.T., IAI

NAMA GAMBAR : Section BCTC  
Hlm : A.01.4  
JUDUL GAMBAR : F Building Section  
SKALA : 1:200, 1:500

DISETUJUI :	NO.	TANGGAL :

CATATAN / REVISI :



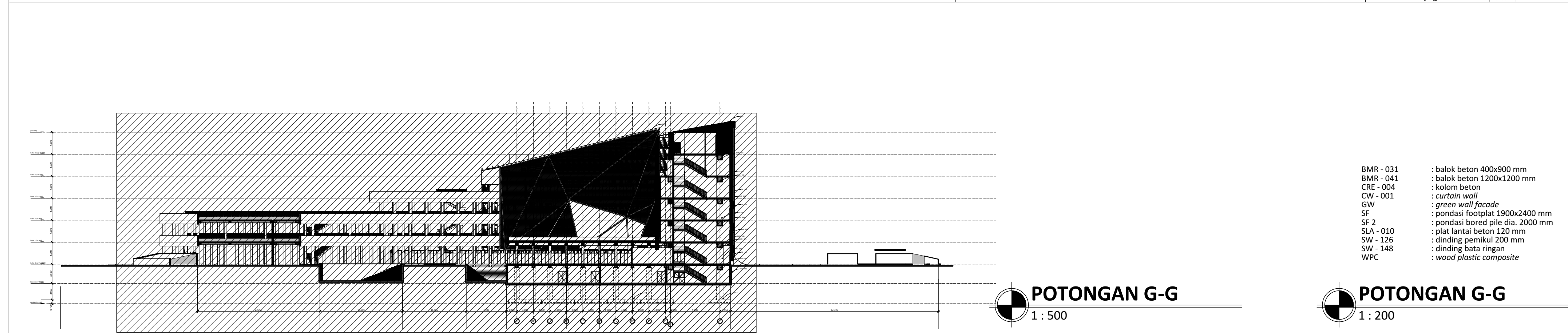
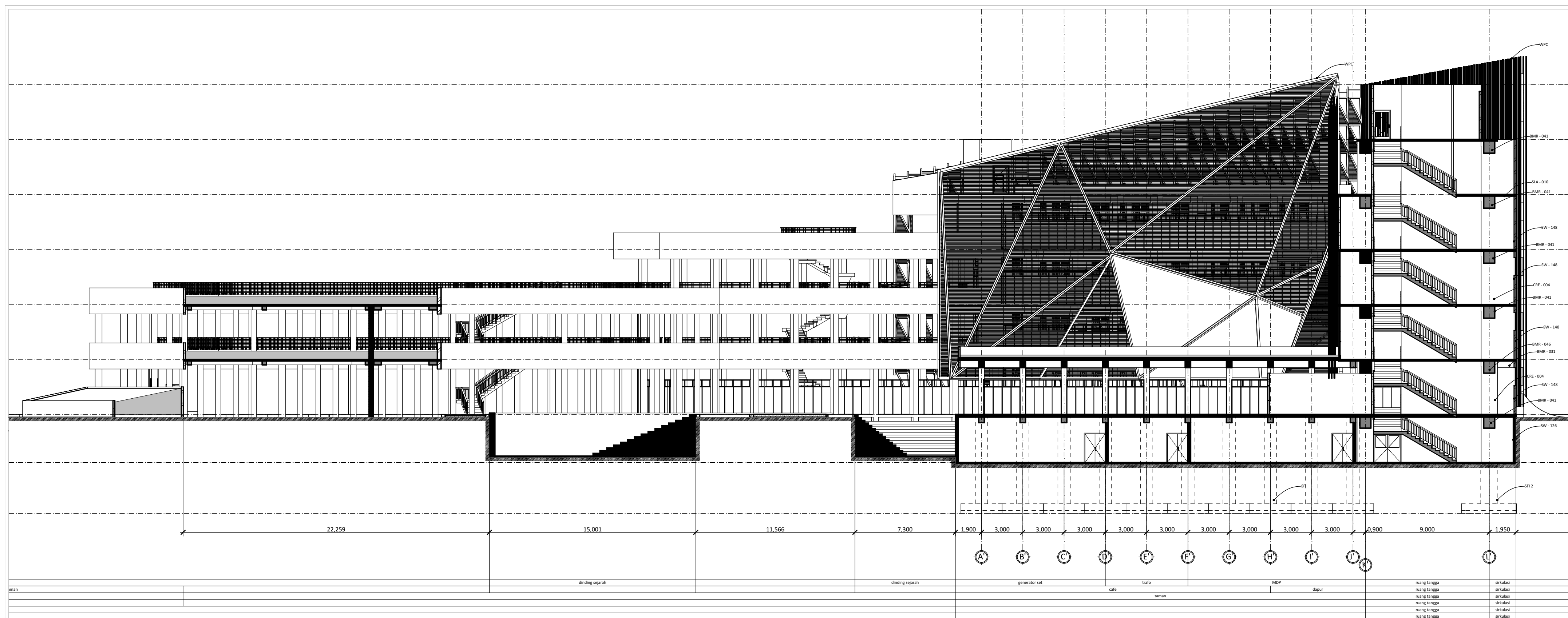

- BMR - 031 : balok beton 400x900 mm
- BMR - 041 : balok beton 1200x1200 mm
- CRE - 004 : kolom beton
- CW - 001 : curtain wall
- GW : green wall facade
- SF : pondasi footplat 1900x2400 mm
- SF 2 : pondasi bored pile dia. 2000 mm
- SLA - 010 : plat lantai beton 120 mm
- SW - 126 : dinding pemikul 200 mm
- SW - 148 : dinding bata ringan
- WPC : wood plastic composite

**POTONGAN G-G**  
1 : 500

**POTONGAN G-G**  
1 : 200

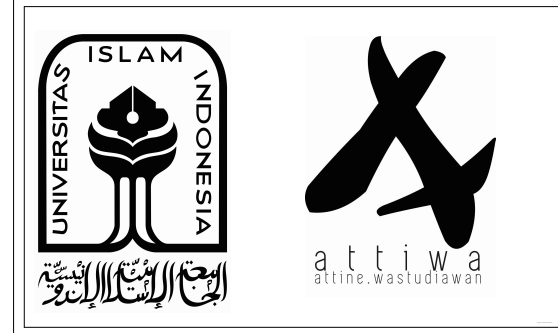

PROYEK AKHIR SARJANA  
  
BANDUNG CULTURE AND TOURISM CENTER

DIBUAT OLEH :  
NAMA : FREDY MAHENDRA  
NIM : 14 512 139  
PEMBIMBING : M. Galieh Gunagama, S.T., M.Sc.  
PENGUJI : Dr. Ir. Sugini, M.T., IAI

NAMA GAMBAR : Section BCTC  
JUDUL GAMBAR : G Building Section

Hlm :	DISETUJUI :	NO.	TANGGAL :
A.01.4			
SKALA :			
1:200, 1:500			

CATATAN / REVISI :

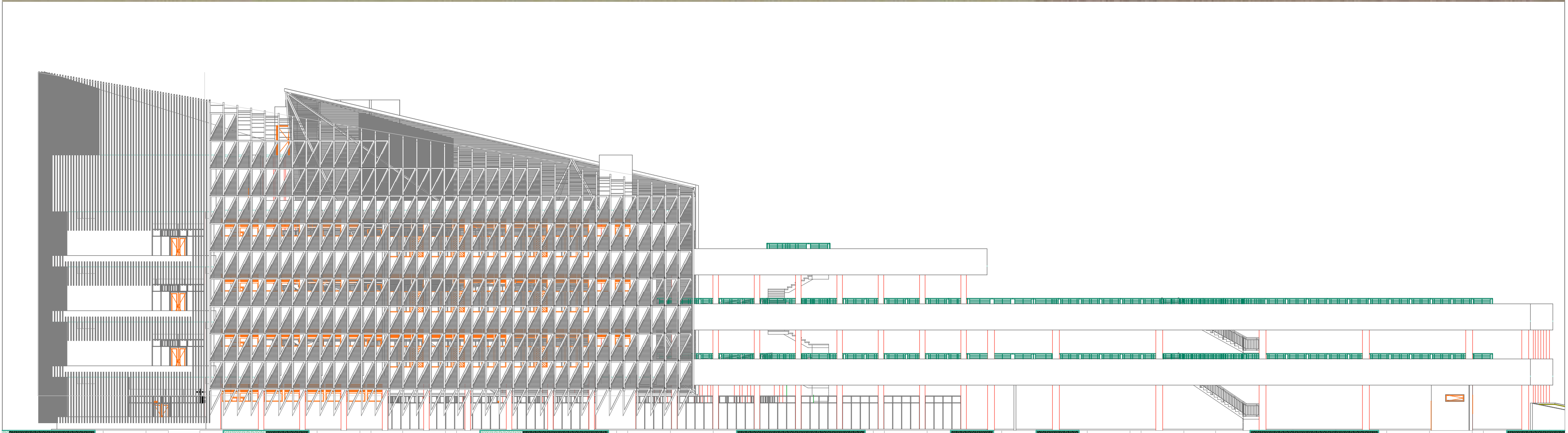

 **TAMPAK BARAT**  
1 : 200

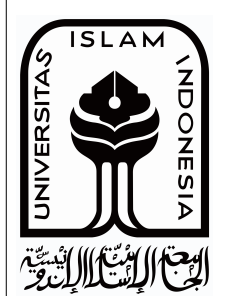

PROYEK AKHIR SARJANA  
  
BANDUNG CULTURE AND TOURISM CENTER

DIBUAT OLEH :

NAMA :	NIM :
FREDY MAHENDRA	14 512 139
PEMBIMBING :	M. Galieh Gunagama, S.T., M.Sc.
PENGUJI :	Dr. Ir. Sugini, M.T., IAI

NAMA GAMBAR :  
Elevation BCTC  
JUDUL GAMBAR :  
E-01 Elevation

Hlm :  
A.01.5  
SKALA :  
1:200

DISETUJUI :

NO.

TANGGAL :

CATATAN / REVISI :



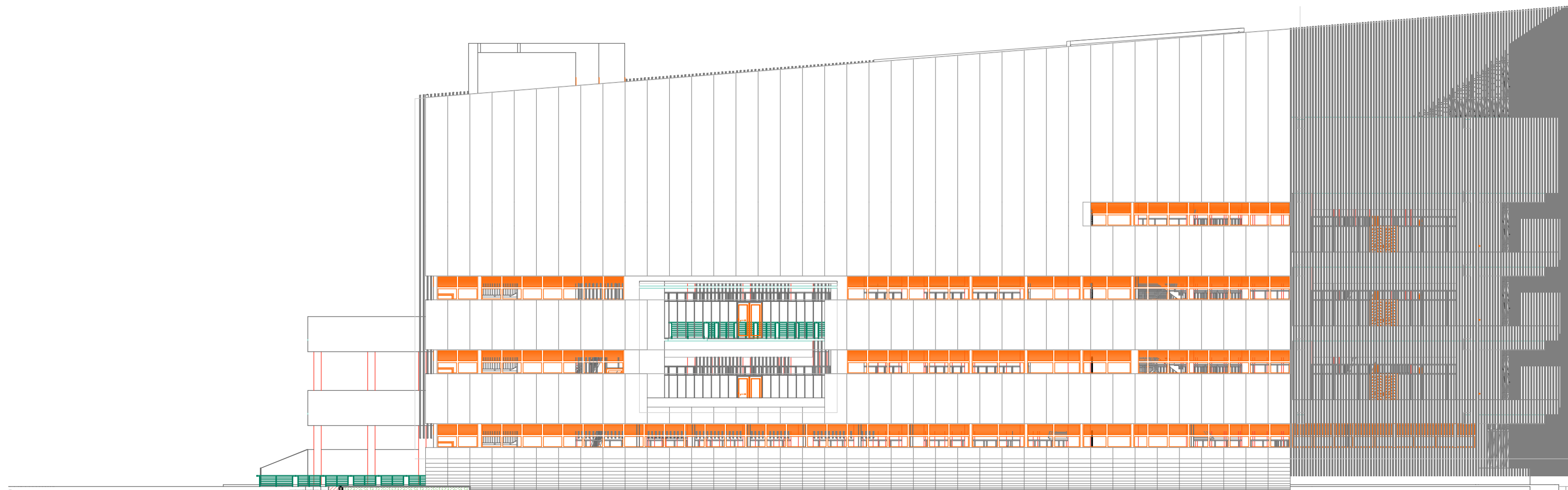

**TAMPAK UTARA**  
1 : 200

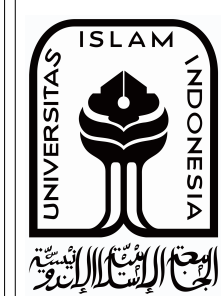

PROYEK AKHIR SARJANA  BANDUNG CULTURE AND TOURISM CENTER	DIBUAT OLEH :		NAMA GAMBAR :		Hlm :	DISETUJUI :	NO.	TANGGAL :	CATATAN / REVISI :
	NAMA :		Elevation BCTC						
	FREDY MAHENDRA		JUDUL GAMBAR :		SKALA :				
	PEMBIMBING :	M. Galieh Gunagama, S.T., M.Sc.	E-02 Elevation		1:200				
	PENGUJI :	Dr. Ir. Sugini, M.T., IAI							

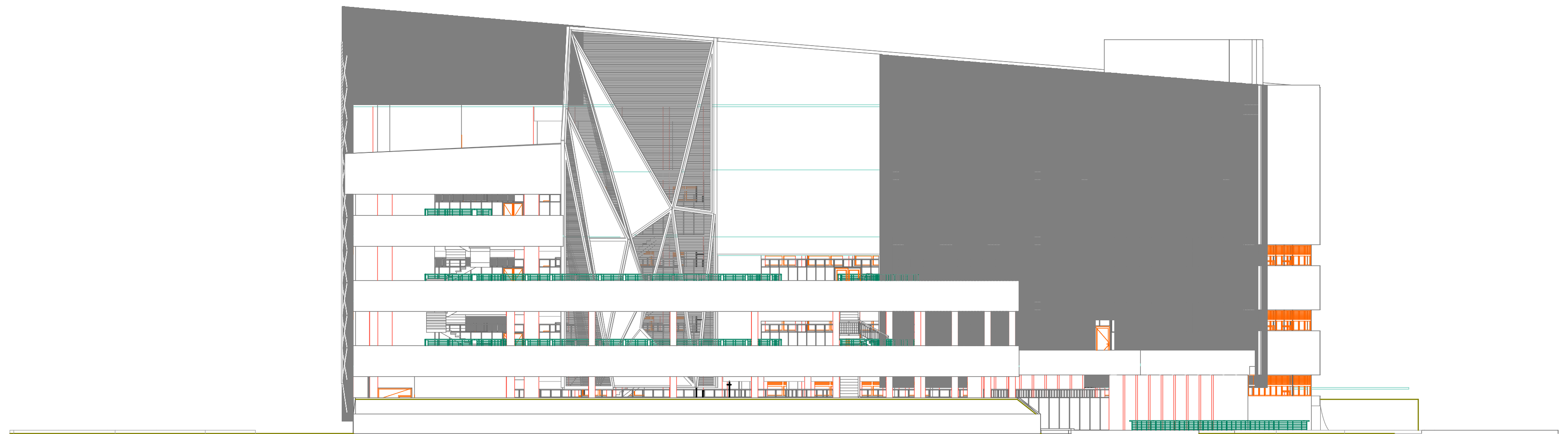

**TAMPAK SELATAN**  
1 : 200

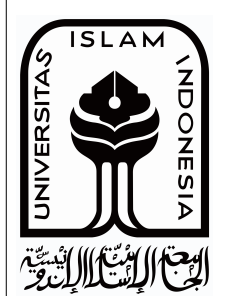

PROYEK AKHIR SARJANA  BANDUNG CULTURE AND TOURISM CENTER	DIBUAT OLEH :		NAMA GAMBAR :		Hlm :	DISETUJUI :	NO.	TANGGAL :	CATATAN / REVISI :
	NAMA :		Elevation BCTC						
	FREDY MAHENDRA		JUDUL GAMBAR :		SKALA :				
	PEMBIMBING :	M. Galieh Gunagama, S.T., M.Sc.	E-03 Elevation		1:200				
PENGUJI :	Dr. Ir. Sugini, M.T., IAI								

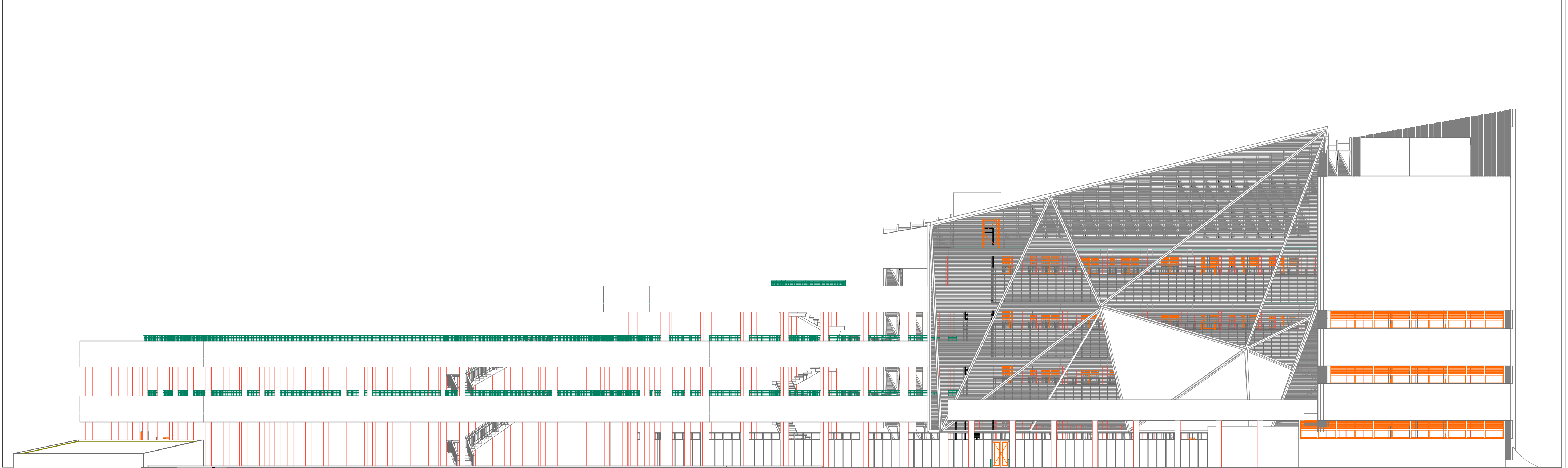

 **TAMPAK TIMUR**  
1 : 200

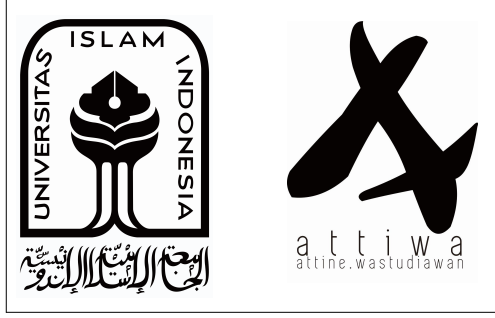

PROYEK AKHIR SARJANA  BANDUNG CULTURE AND TOURISM CENTER	DIBUAT OLEH :		NAMA GAMBAR :	Hlm :	DISETUJUI :	NO.	TANGGAL :	CATATAN / REVISI :
	NAMA :	NIM :	Elevation BCTC	A.01.5				
	FREDY MAHENDRA	14 512 139	JUDUL GAMBAR :	SKALA :				
	PEMBIMBING :	M. Galieh Gunagama, S.T., M.Sc.	E-04 Elevation	1:200				
	PENGUJI :	Dr. Ir. Sugini, M.T., IAI						



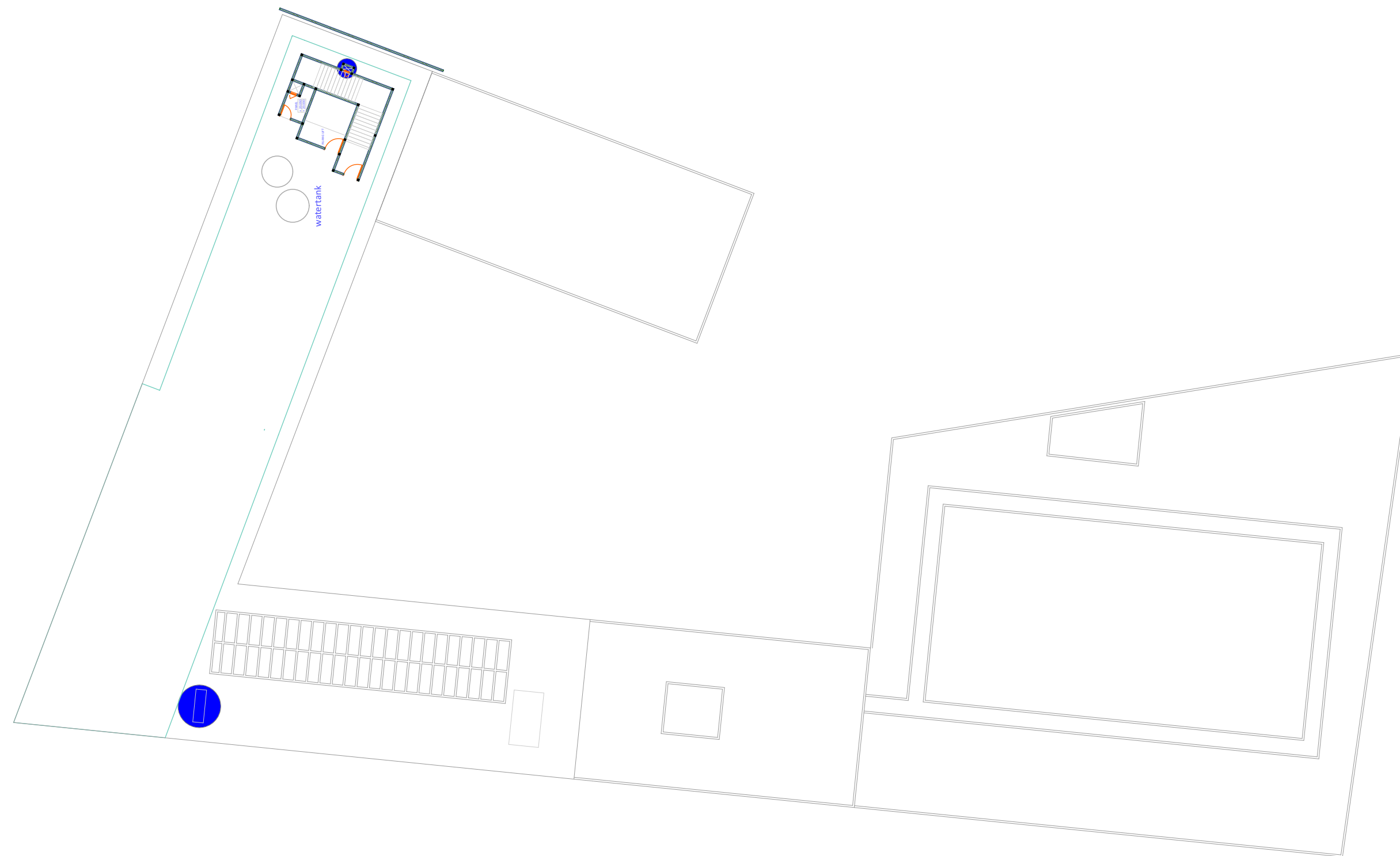

**RENCANA AIR BERSIH**  
*lantai rooftop*  
 1 : 350

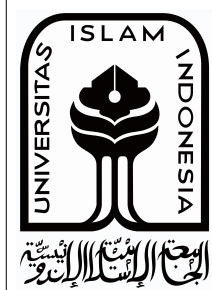

PROYEK AKHIR SARJANA  BANDUNG CULTURE AND TOURISM CENTER	DIBUAT OLEH :		NAMA GAMBAR :		Hlm :	DISETUJUI :	NO.	TANGGAL :	CATATAN / REVISI :
	NAMA :		Skema Air Bersih						
	FREDY MAHENDRA		JUDUL GAMBAR :		SKALA :				
	PEMBIMBING :	M. Galieh Gunagama, S.T., M.Sc.		5. Story	1:350				
	PENGUJI :	Dr. Ir. Sugini, M.T., IAI							





**RENCANA AIR BERSIH**  
*lantai 3*  
 1 : 350

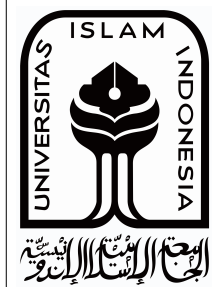

PROYEK AKHIR SARJANA  BANDUNG CULTURE AND TOURISM CENTER	DIBUAT OLEH :		NAMA GAMBAR :		Hlm :	DISETUJUI :	NO.	TANGGAL :	CATATAN / REVISI :
	NAMA :		Skema Air Bersih						
	FREDY MAHENDRA		NIM :		JUDUL GAMBAR :		SKALA :		
	PEMBIMBING :	M. Galieh Gunagama, S.T., M.Sc.		3. Story		1:350			
PENGUJI :	Dr. Ir. Sugini, M.T., IAI								





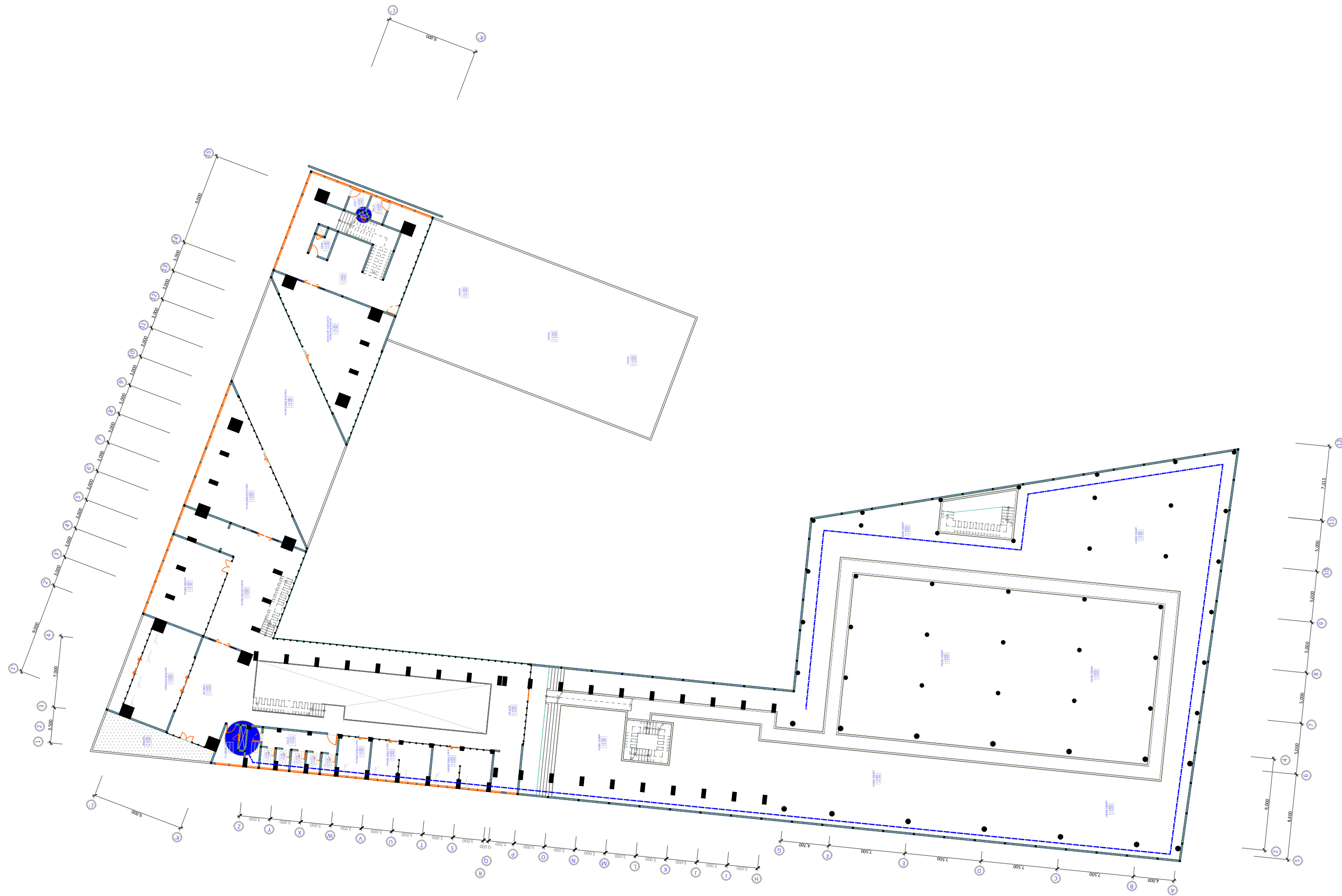

**RENCANA AIR BERSIH**  
*lantai 1*  
 1 : 350

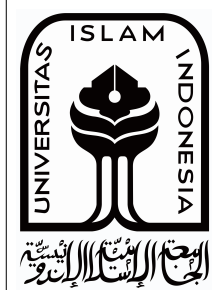

PROYEK AKHIR SARJANA  BANDUNG CULTURE AND TOURISM CENTER	DIBUAT OLEH :		NAMA GAMBAR :		Hlm :	DISETUJUI :	NO.	TANGGAL :	CATATAN / REVISI :
	NAMA :		Skema Air Bersih		A.01.6.1				
	FREDY MAHENDRA		JUDUL GAMBAR :		SKALA :				
	PEMBIMBING :	M. Galieh Gunagama, S.T., M.Sc.		1. Story		1:350			
	PENGUJI :	Dr. Ir. Sugini, M.T., IAI							

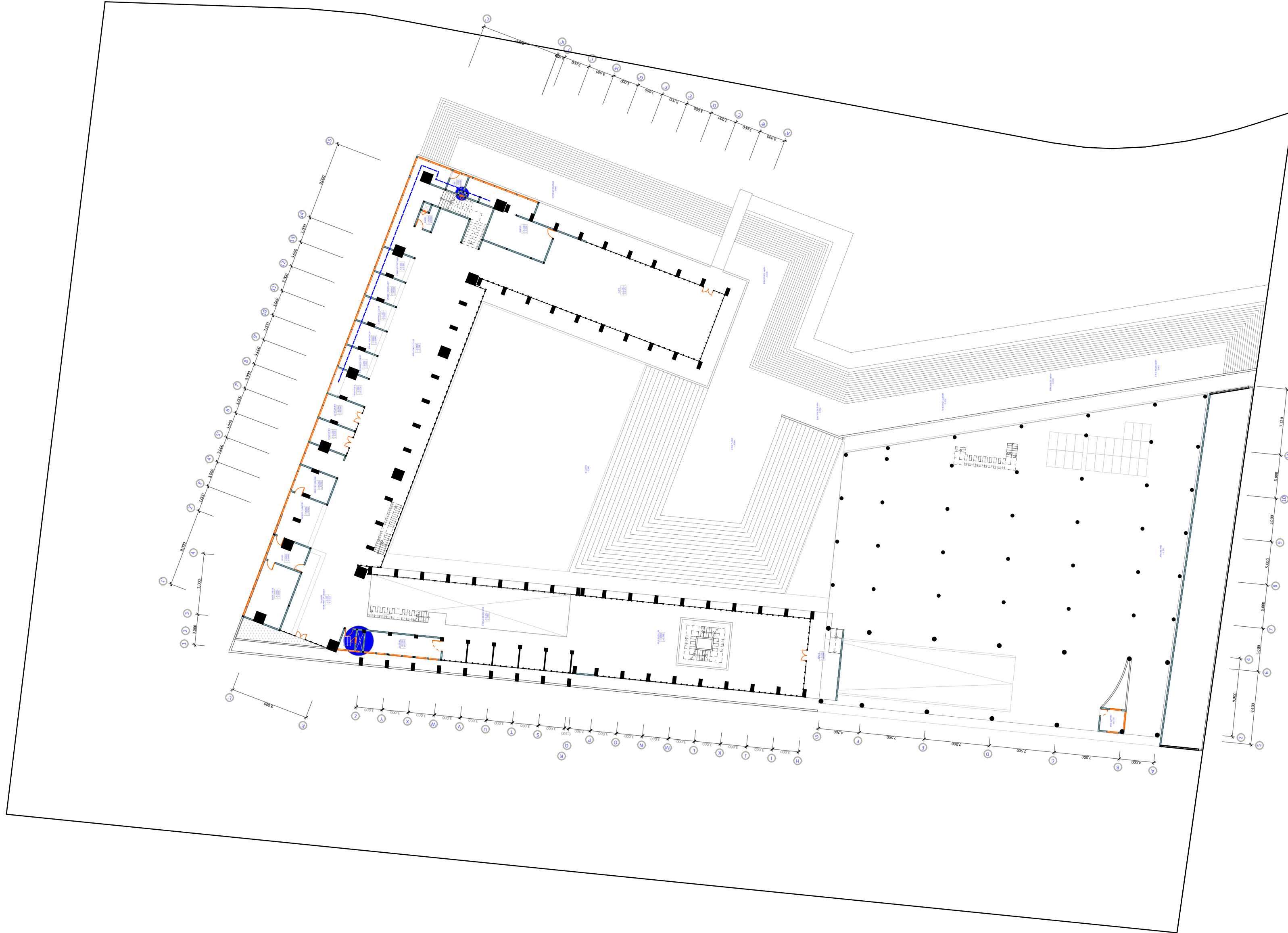

**RENCANA AIR BERSIH**  
*lantai dasar*  
 1 : 350

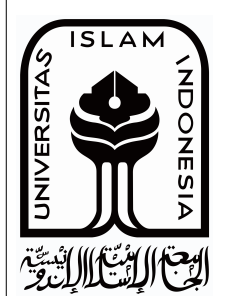

PROYEK AKHIR SARJANA  BANDUNG CULTURE AND TOURISM CENTER	DIBUAT OLEH :		NAMA GAMBAR :		Hlm :	DISETUJUI :	NO.	TANGGAL :	CATATAN / REVISI :
	NAMA :	NIM :	Skema Air Bersih	A.01.6.1					
	FREDY MAHENDRA	14 512 139	JUDUL GAMBAR :		SKALA :				
	PEMBIMBING :	M. Galieh Gunagama, S.T., M.Sc.	0. Ground Floor		1:350				
	PENGUJI :	Dr. Ir. Sugini, M.T., IAI							



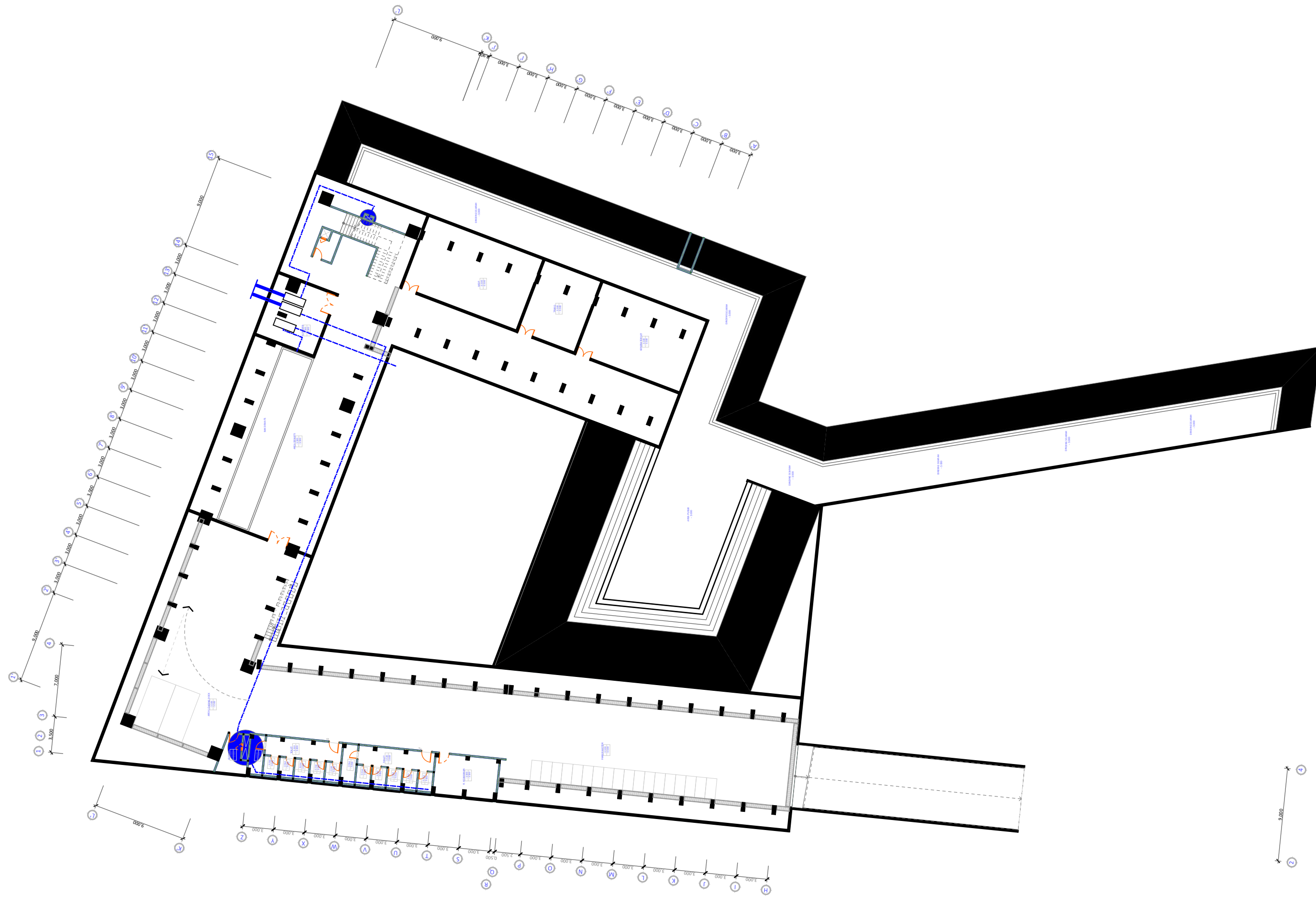

**RENCANA AIR BERSIH**  
*lantai basement*  
 1 : 350

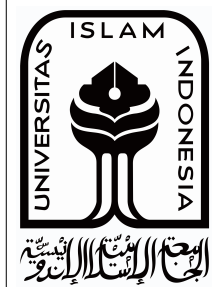

PROYEK AKHIR SARJANA		DIBUAT OLEH :		NAMA GAMBAR :		Hlm :	DISETUJUI :	NO.	TANGGAL :	CATATAN / REVISI :	
BANDUNG CULTURE AND TOURISM CENTER		NAMA :		Skema Air Bersih		A.01.6.1					
		FREDY MAHENDRA		JUDUL GAMBAR :		SKALA :					
		PEMBIMBING :	M. Galieh Gunagama, S.T., M.Sc.		-1. Story						1:350
		PENGUJI :	Dr. Ir. Sugini, M.T., IAI								

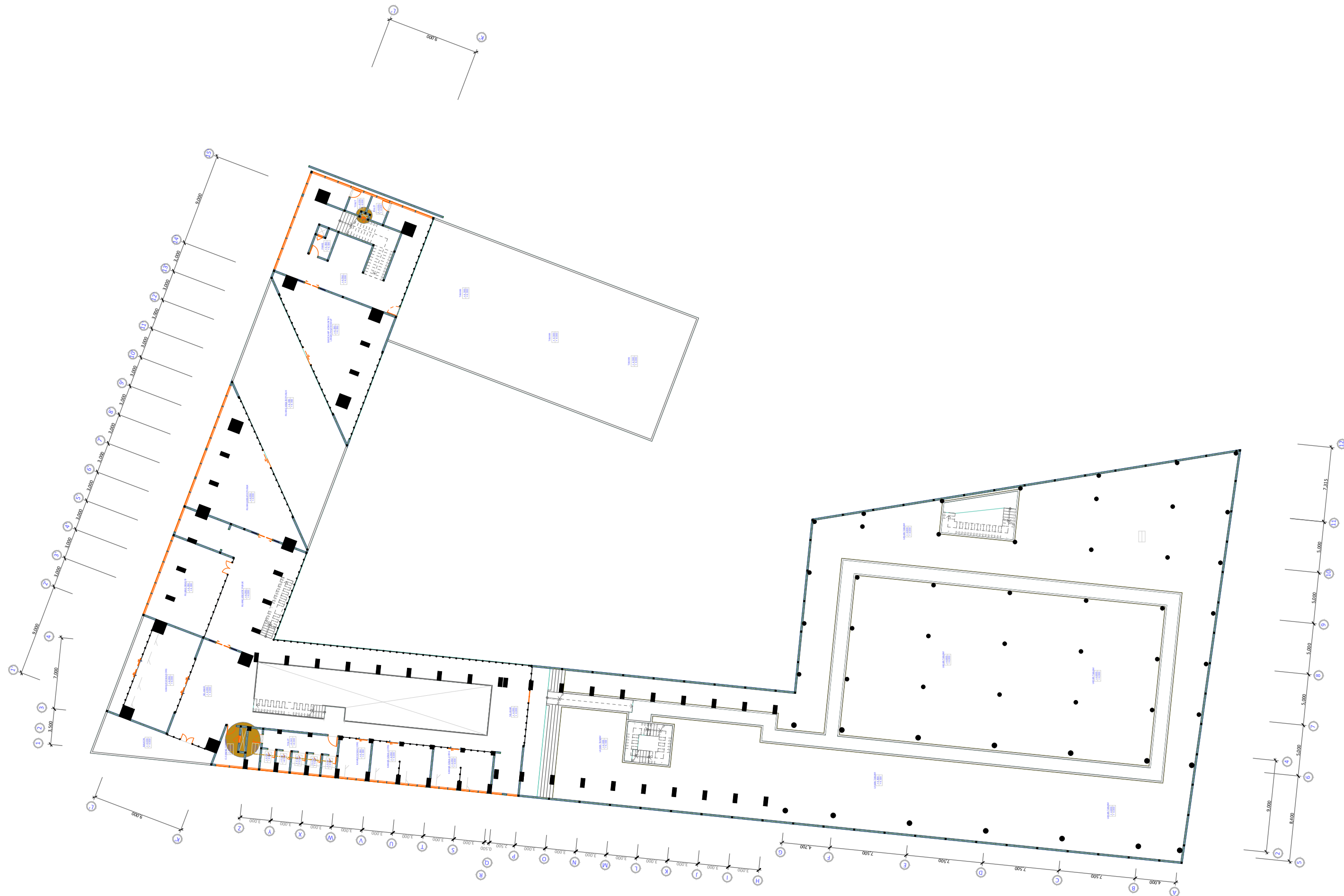

**RENCANA AIR KOTOR**  
*lantai typical (1,2,3)*  
 1 : 350

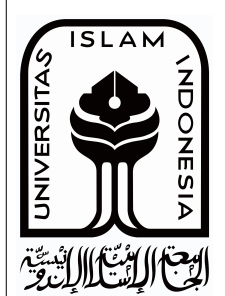

PROYEK AKHIR SARJANA  BANDUNG CULTURE AND TOURISM CENTER	DIBUAT OLEH :		NAMA GAMBAR :		Hlm :	DISETUJUI :	NO.	TANGGAL :	CATATAN / REVISI :
	NAMA :		NIM :						
	FREDY MAHENDRA		14 512 139		JUDUL GAMBAR :		SKALA :		
	PEMBIMBING :	M. Galieh Gunagama, S.T., M.Sc.		1. Story		1:350			
PENGUJI :	Dr. Ir. Sugini, M.T., IAI								

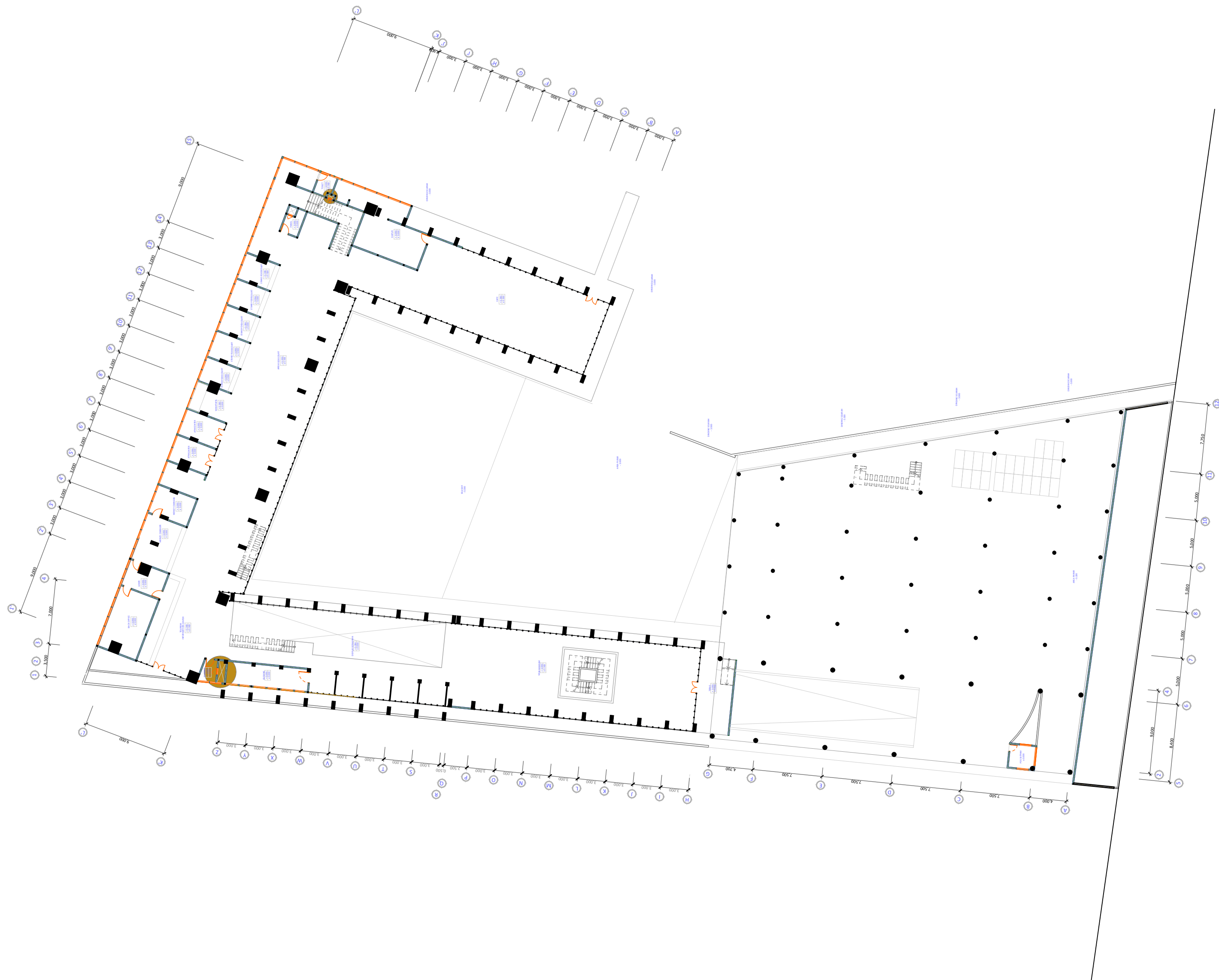

**RENCANA AIR KOTOR**  
*lantai dasar*  
 1 : 350

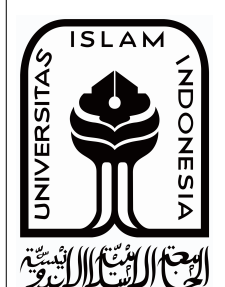

PROYEK AKHIR SARJANA  BANDUNG CULTURE AND TOURISM CENTER	DIBUAT OLEH :		NAMA GAMBAR :		Hlm :	DISETUJUI :	NO.	TANGGAL :	CATATAN / REVISI :
	NAMA :	NIM :	Skema Air Kotor	A.01.6.2					
	FREDY MAHENDRA	14 512 139	JUDUL GAMBAR :		SKALA :				
	PEMBIMBING :	M. Galieh Gunagama, S.T., M.Sc.	0. Ground Floor		1:350				
	PENGUJI :	Dr. Ir. Sugini, M.T., IAI							



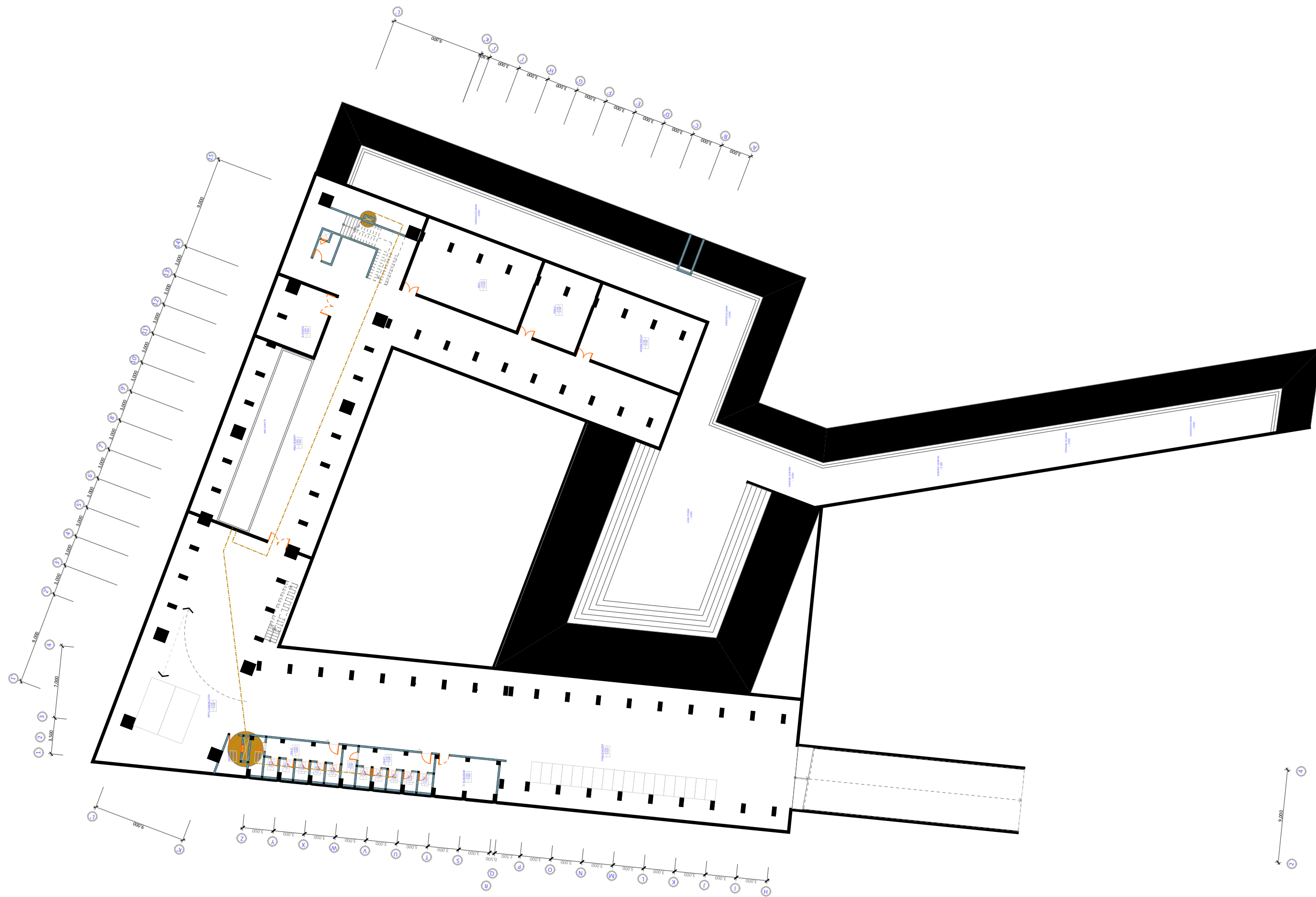

**RENCANA AIR KOTOR**  
*lantai basement*  
 1 : 350

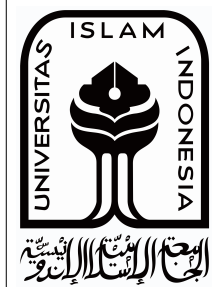

PROYEK AKHIR SARJANA  
 BANDUNG CULTURE AND TOURISM CENTER

DIBUAT OLEH :

NAMA :	NIM :
FREDY MAHENDRA	14 512 139
PEMBIMBING :	M. Galieh Gunagama, S.T., M.Sc.
PENGUJI :	Dr. Ir. Sugini, M.T., IAI

NAMA GAMBAR :  
 Skema Air Kotor  
 JUDUL GAMBAR :  
 -1. Story

Hlm :  
 A.01.6.2  
 SKALA :  
 1:350

NO.	TANGGAL :

CATATAN / REVISI :

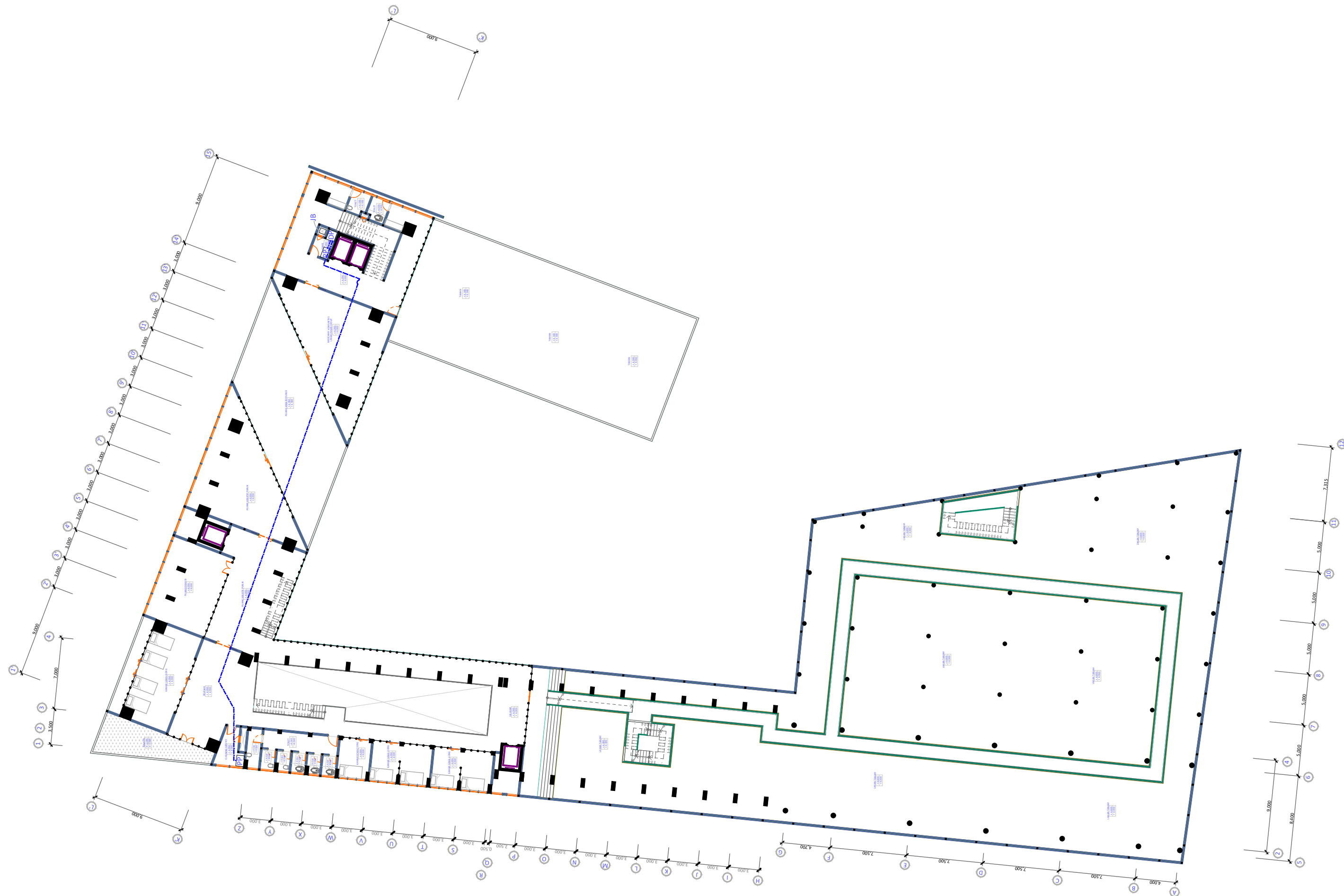

- TD : traffo step down
- GS : generator set
- MDP : main distribution panel
- SDP : sub distribution panel
- PP : panel pembagi
- JB : junction box

**SKEMA ELEKTRIKAL**  
*lantai typical*  
 1 : 350



PROYEK AKHIR SARJANA	DIBUAT OLEH :		NAMA GAMBAR :	Hlm :	DISETUJUI :	NO.	TANGGAL :	CATATAN / REVISI :
BANDUNG CULTURE AND TOURISM CENTER	NAMA :	NIM :	Skema Elektrikal	A.01.11				
	FREDY MAHENDRA		14 512 139	JUDUL GAMBAR :	SKALA :			
	PEMBIMBING :	M. Galieh Gunagama, S.T., M.Sc.		1. Story	1:350			
	PENGUJI :	Dr. Ir. Sugini, M.T., IAI						

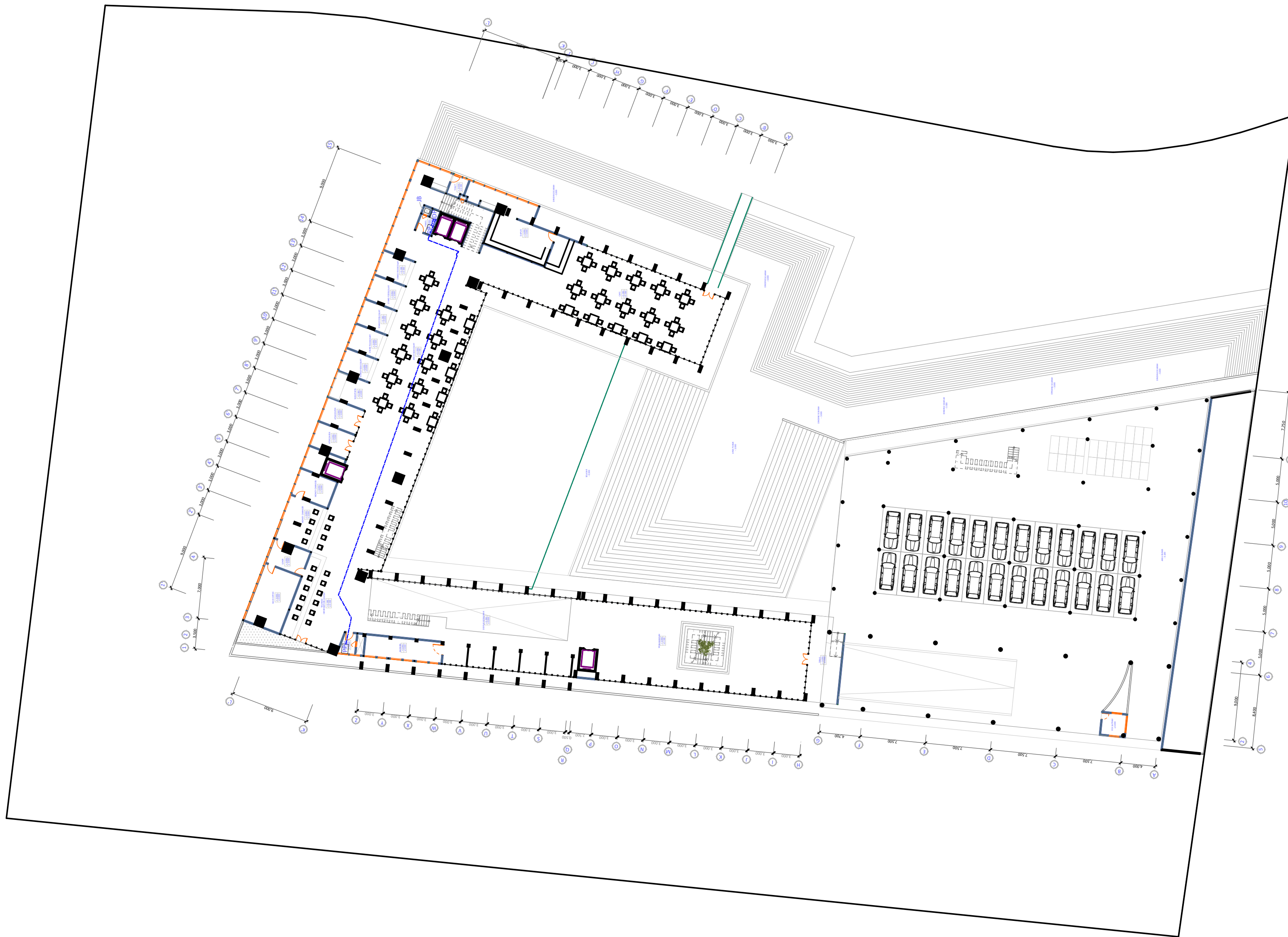

- TD : traffo step down
- GS : generator set
- MDP : main distribution panel
- SDP : sub distribution panel
- PP : panel pembagi
- JB : junction box

**SKEMA ELEKTRIKAL**  
*lantai dasar*  
 1 : 350

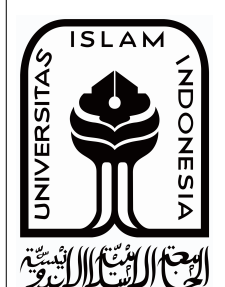

PROYEK AKHIR SARJANA  BANDUNG CULTURE AND TOURISM CENTER	DIBUAT OLEH :  NAMA : FREDY MAHENDRA NIM : 14 512 139  PEMBIMBING : M. Galieh Gunagama, S.T., M.Sc. PENGUJI : Dr. Ir. Sugini, M.T., IAI	NAMA GAMBAR : Skema Elektrikal JUDUL GAMBAR : 0. Ground Floor Hlm : A.01.11 SKALA : 1:350	DISETUJUI :	NO.	TANGGAL :	CATATAN / REVISI :



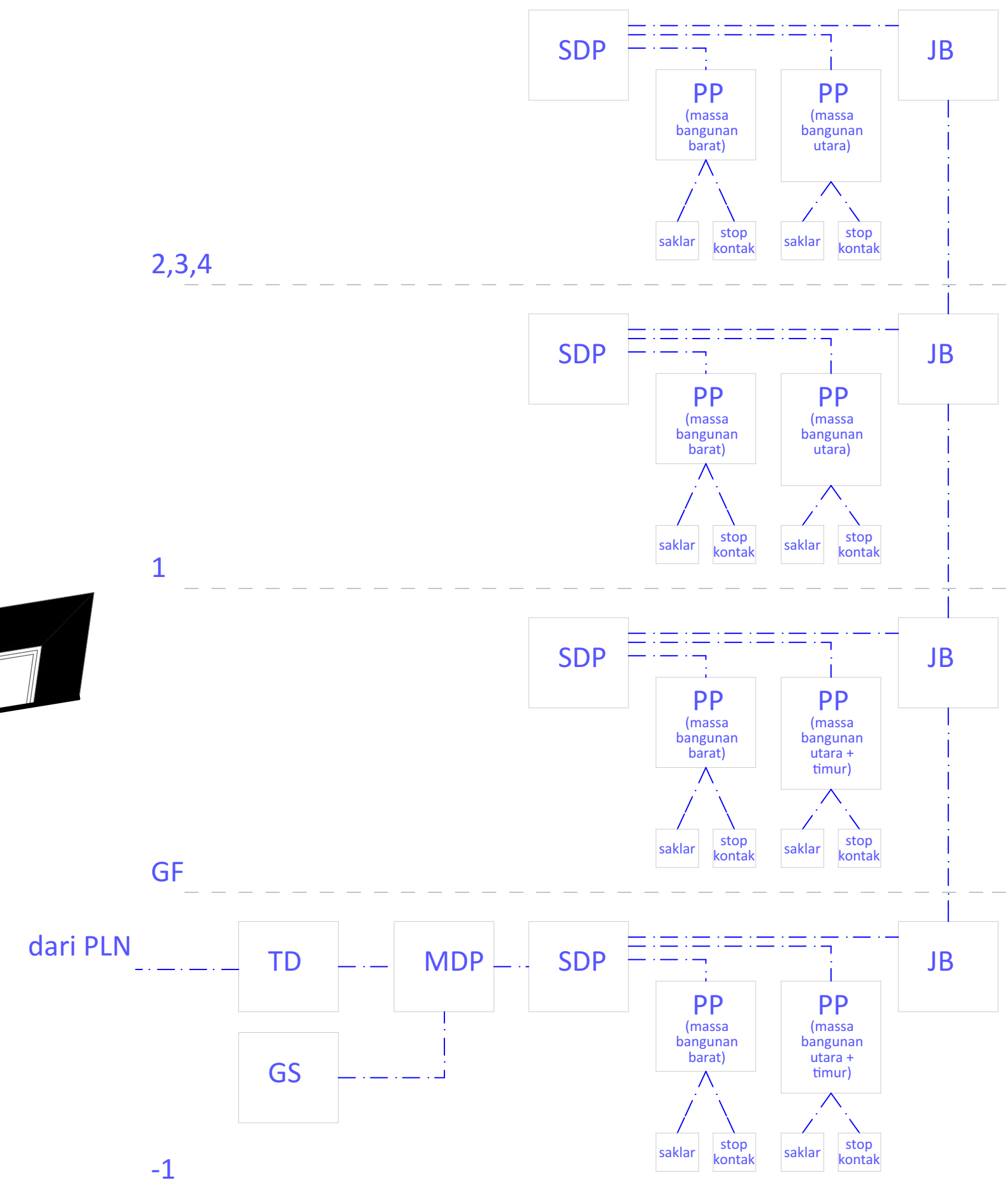
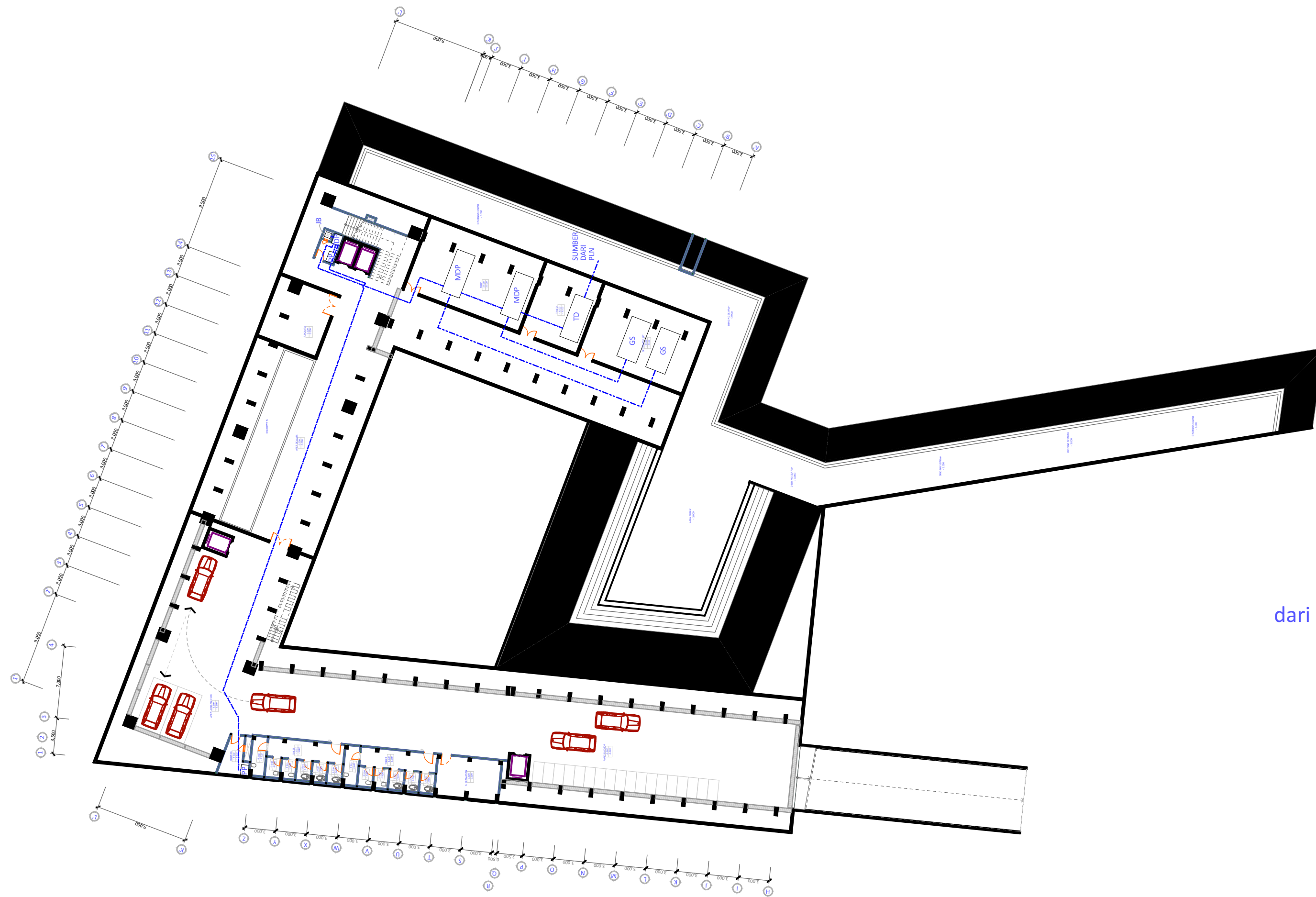

- TD : traffo step down
- GS : generator set
- MDP : main distribution panel
- SDP : sub distribution panel
- PP : panel pembagi
- JB : junction box

**SKEMA ELEKTRIKAL**  
*lantai basement*  
 1 : 350









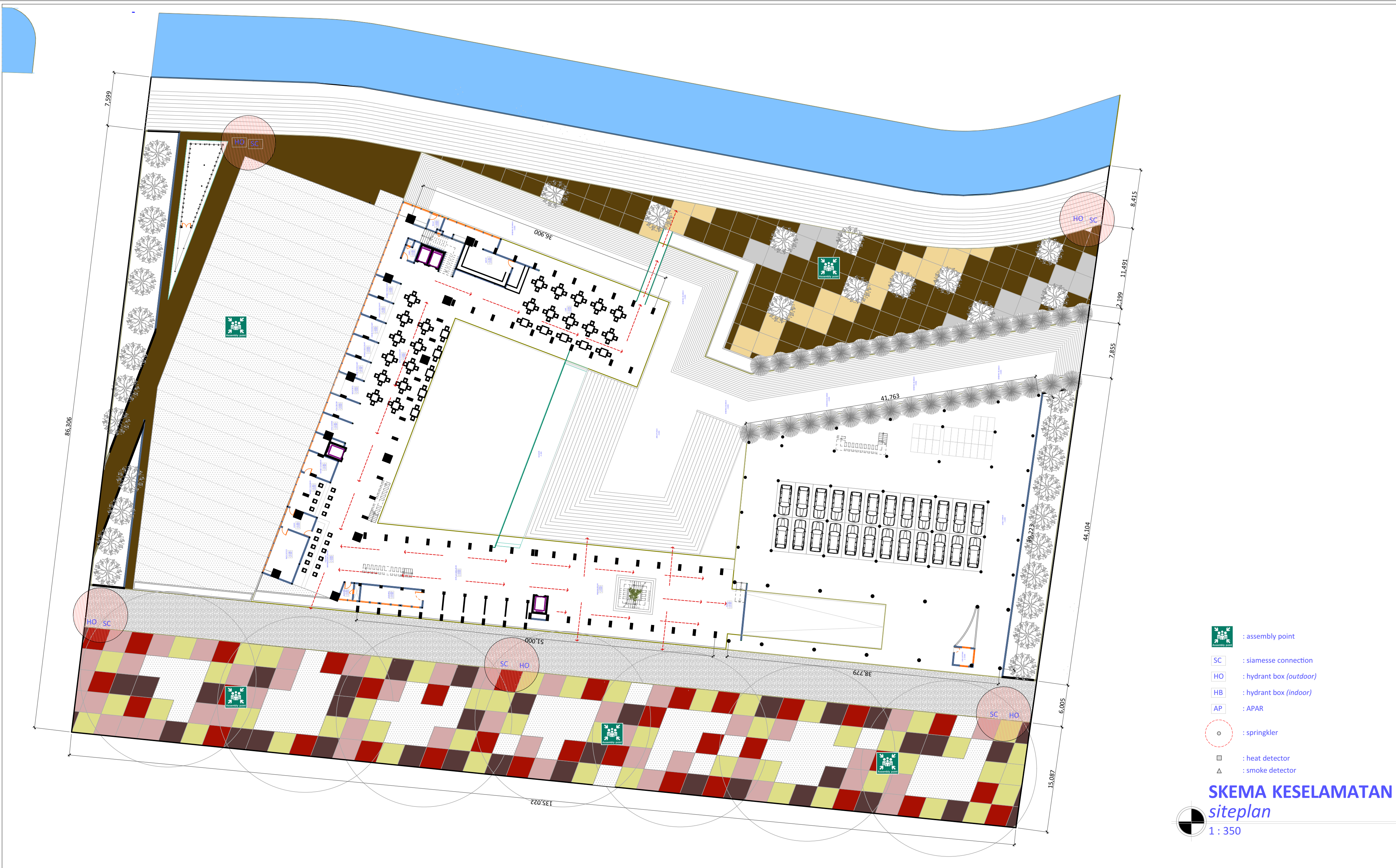

PROYEK AKHIR SARJANA	DIBUAT OLEH :		NAMA GAMBAR :	Hlm :	DISETUJUI :	NO.	TANGGAL :	CATATAN / REVISI :
BANDUNG CULTURE AND TOURISM CENTER	NAMA :	NIM :	Skema Elektrikal	A.01.11				
	FREDY MAHENDRA	14 512 139	JUDUL GAMBAR :	SKALA :				
	PEMBIMBING :	M. Galieh Gunagama, S.T., M.Sc.		-1. Story	1:350			
	PENGUJI :	Dr. Ir. Sugini, M.T., IAI						







-  : assembly point
-  : siamese connection
-  : hydrant box (outdoor)
-  : hydrant box (indoor)
-  : APAR
-  : springkler
-  : heat detector
-  : smoke detector

**SKEMA KESELAMATAN**  
*siteplan*  
 1 : 350

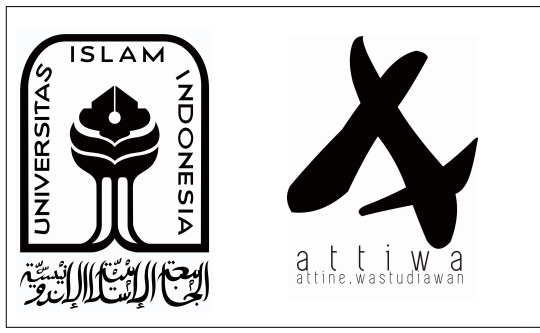

PROYEK AKHIR SARJANA		DIBUAT OLEH :		NAMA GAMBAR :		Hlm :	DISETUJUI :	NO.	TANGGAL :	CATATAN / REVISI :	
BANDUNG CULTURE AND TOURISM CENTER		NAMA :		Rencana Keselamatan		A.019					
		FREDY MAHENDRA		14 512 139		JUDUL GAMBAR :	SKALA :				
		PEMBIMBING :	M. Galieh Gunagama, S.T., M.Sc.		0. Tapak		1:350				
		PENGUJI :	Dr. Ir. Sugini, M.T., IAI								





- SC : siamese connection
- HO : hydrant box (outdoor)
- HB : hydrant box (indoor)
- AP : APAR
- : springler
- : heat detector
- △ : smoke detector

**SKEMA KESELAMATAN**

**lantai 3**

1 : 350

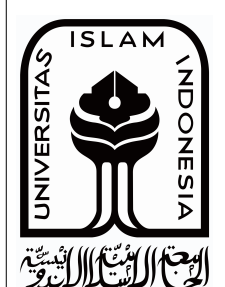

PROYEK AKHIR SARJANA  <b>BANDUNG CULTURE AND TOURISM CENTER</b>	DIBUAT OLEH :		NAMA GAMBAR :	Hlm :	DISETUJUI :	NO.	TANGGAL :	CATATAN / REVISI :	
	NAMA :	NIM :	Rencana Keselamatan	A.01.9					
	FREDY MAHENDRA		14 512 139	JUDUL GAMBAR :		SKALA :			
	PEMBIMBING :	M. Galieh Gunagama, S.T., M.Sc.		3. Story		1:350			
	PENGUJI :	Dr. Ir. Sugini, M.T., IAI							



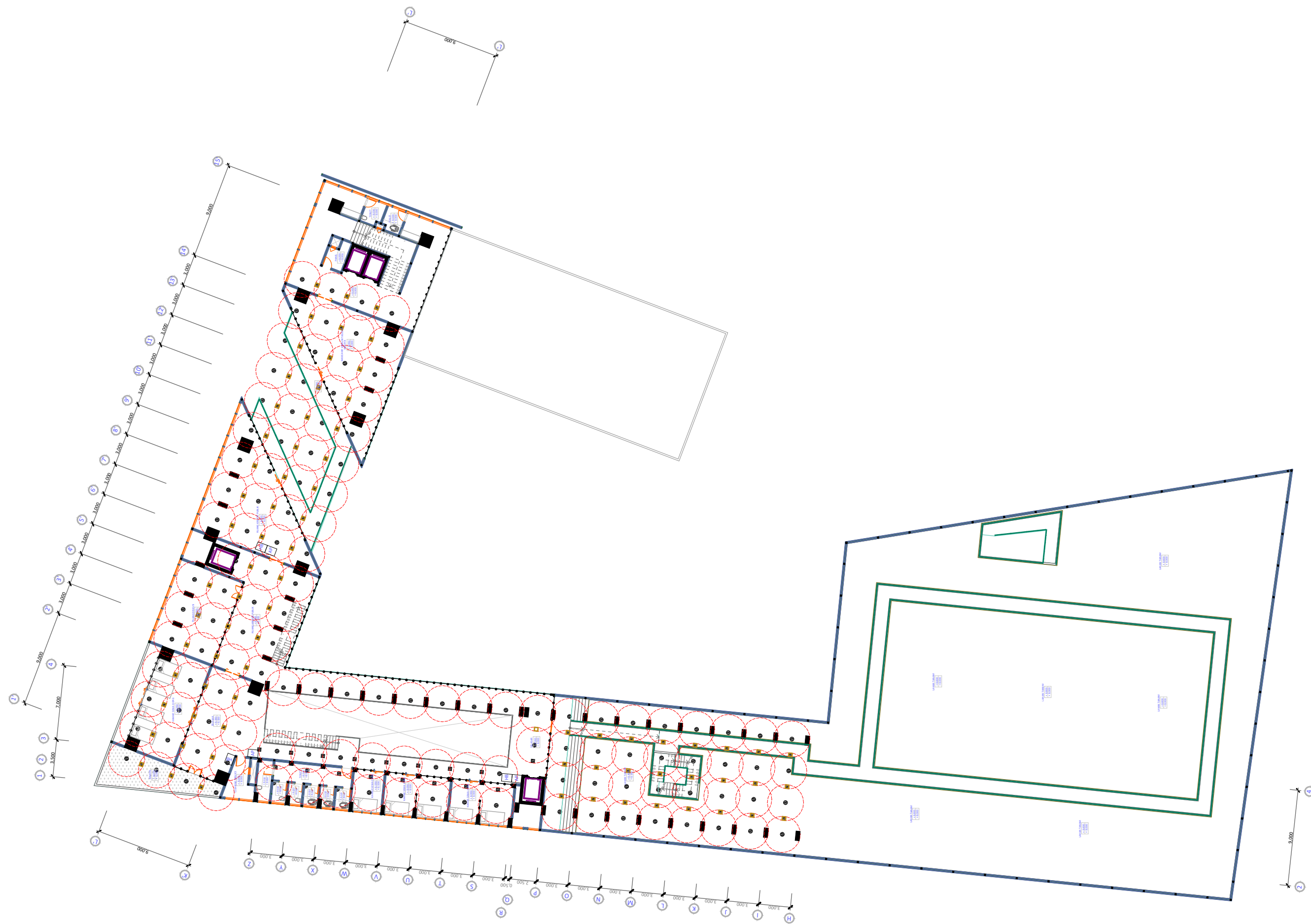

- SC : siamesse connection
- HO : hydrant box (outdoor)
- HB : hydrant box (indoor)
- AP : APAR
- : springkler
- : heat detector
- △ : smoke detector

**SKEMA KESELAMATAN**  
**lantai 2**  
 1 : 350

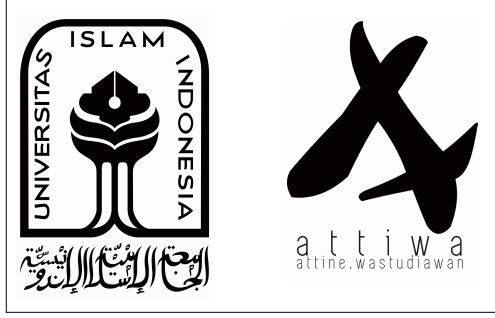

PROYEK AKHIR SARJANA	DIBUAT OLEH :		NAMA GAMBAR :	Hlm :	DISETUJUI :	NO.	TANGGAL :	CATATAN / REVISI :
BANDUNG CULTURE AND TOURISM CENTER	NAMA :	NIM :	Rencana Keselamatan	A.01.9				
	FREDY MAHENDRA	14 512 139	JUDUL GAMBAR :	SKALA :				
	PEMBIMBING :	M. Galieh Gunagama, S.T., M.Sc.		2. Story	1:350			
	PENGUJI :	Dr. Ir. Sugini, M.T., IAI						

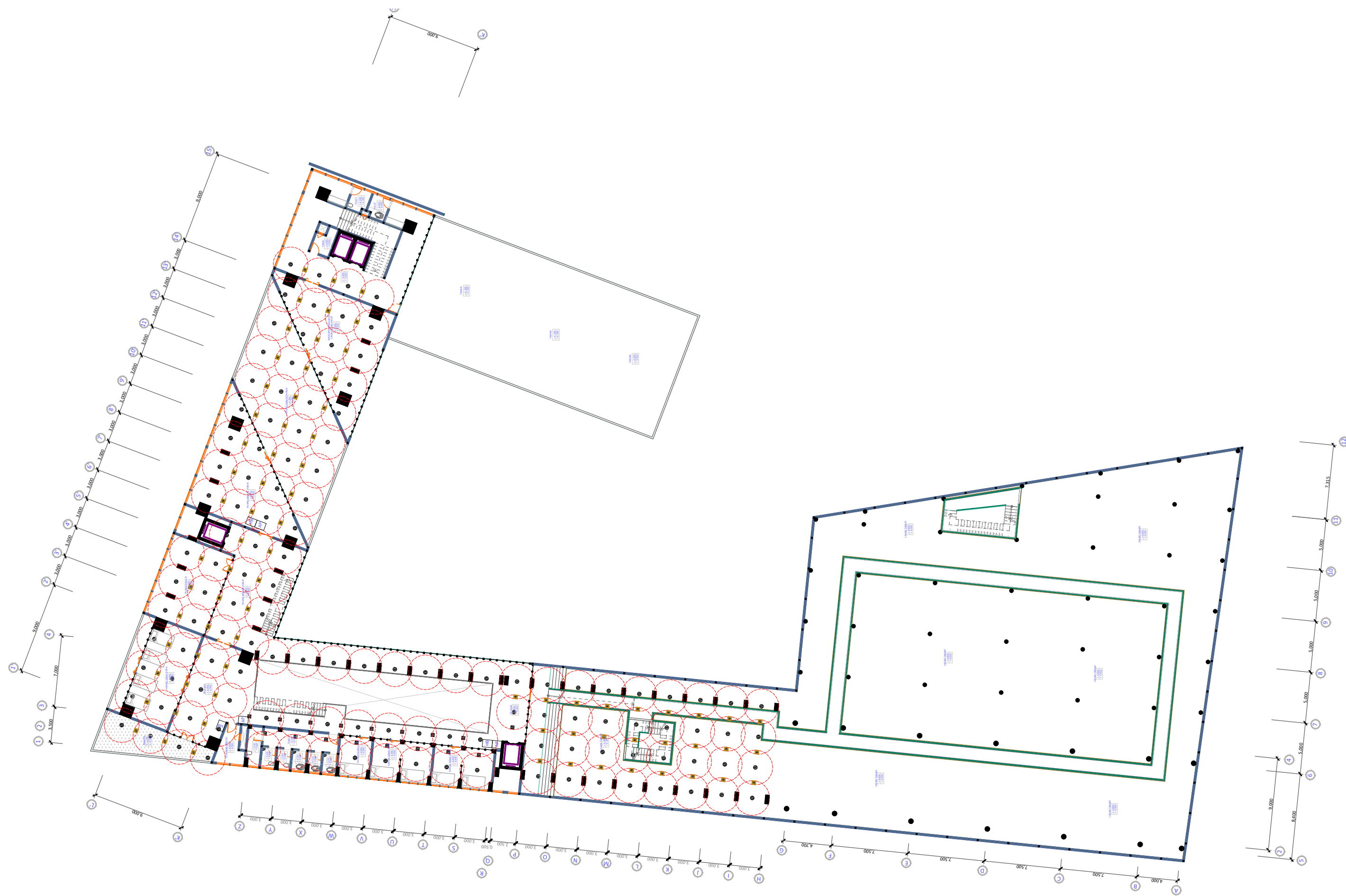

- SC : siamesse connection
- HO : hydrant box (outdoor)
- HB : hydrant box (indoor)
- AP : APAR
- : springkler
- : heat detector
- △ : smoke detector

**SKEMA KESELAMATAN**

**lantai 1**

1 : 350

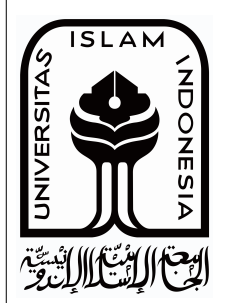

PROYEK AKHIR SARJANA  <b>BANDUNG CULTURE AND TOURISM CENTER</b>	DIBUAT OLEH :		NAMA GAMBAR :		Hlm :	DISETUJUI :	NO.	TANGGAL :	CATATAN / REVISI :	
	NAMA :	NIM :	Rencana Keselamatan	A.01.9						
	FREDY MAHENDRA		14 512 139	JUDUL GAMBAR :		SKALA :				
	PEMBIMBING :	M. Galieh Gunagama, S.T., M.Sc.		1. Story		1:350				
	PENGUJI :	Dr. Ir. Sugini, M.T., IAI								



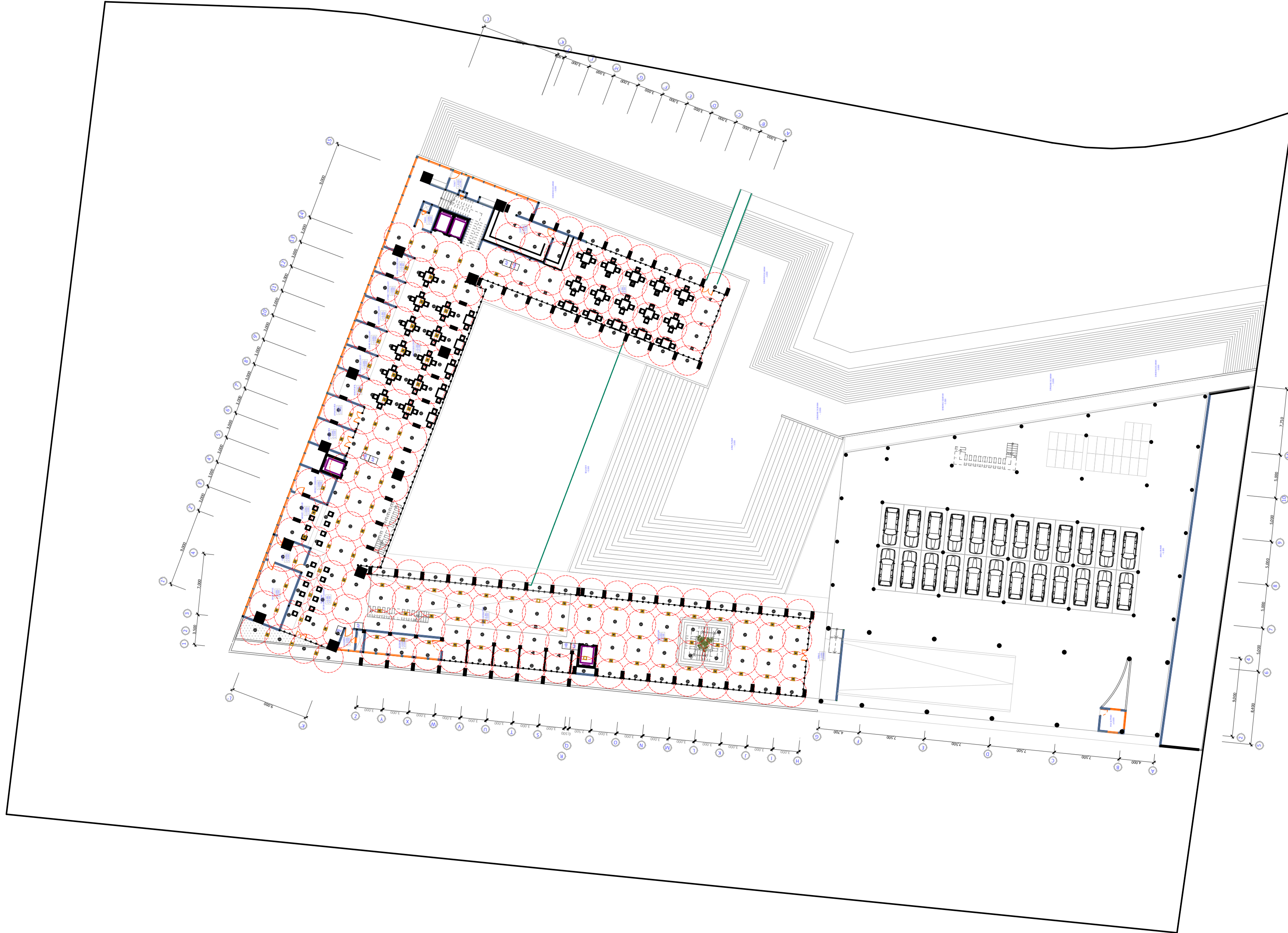

- SC : siamesse connection
- HO : hydrant box (outdoor)
- HB : hydrant box (indoor)
- AP : APAR
- : sprinkler
- : heat detector
- △ : smoke detector

**SKEMA KESELAMATAN**  
*lantai dasar*  
 1 : 350

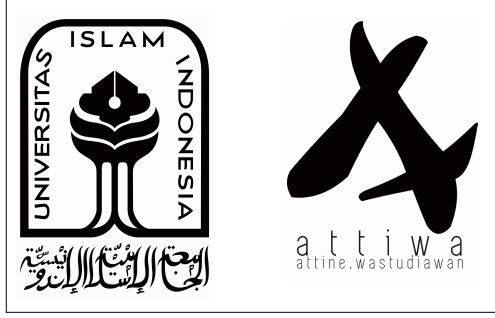

PROYEK AKHIR SARJANA  BANDUNG CULTURE AND TOURISM CENTER	DIBUAT OLEH :  NAMA : FREDY MAHENDRA NIM : 14 512 139  PEMBIMBING : M. Galieh Gunagama, S.T., M.Sc. PENGUJI : Dr. Ir. Sugini, M.T., IAI	NAMA GAMBAR : Rencana Keselamatan JUDUL GAMBAR : 0. Ground Floor  Hlm : A.01.9 SKALA : 1:350	DISETUJUI :  NO. :  TANGGAL :	CATATAN / REVISI :
--	---	--	---	--------------------



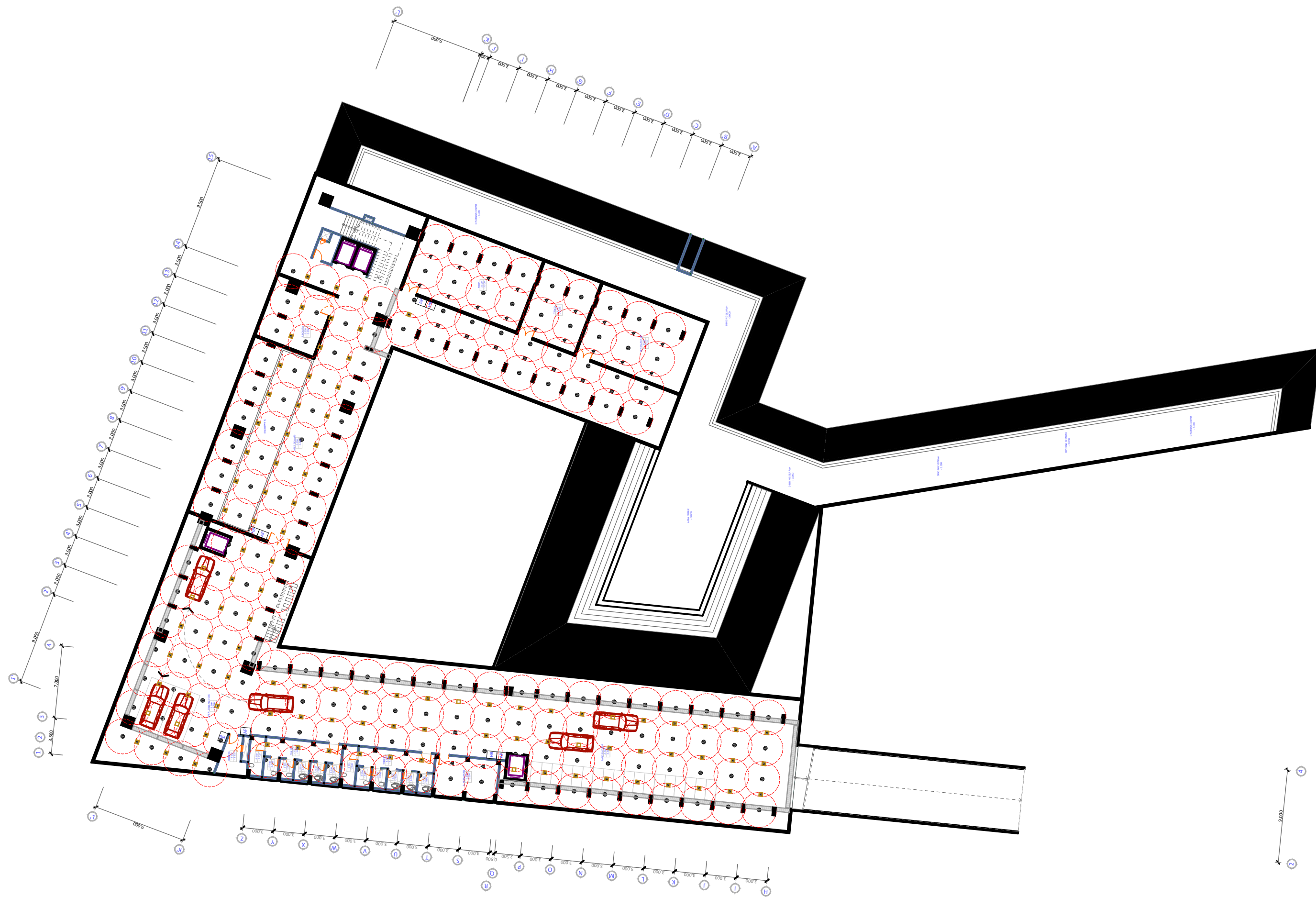

- SC : siamese connection
- HO : hydrant box (outdoor)
- HB : hydrant box (indoor)
- AP : APAR
- : springkler
- : heat detector
- △ : smoke detector

**SKEMA KESELAMATAN**  
*lantai basement*

1 : 350

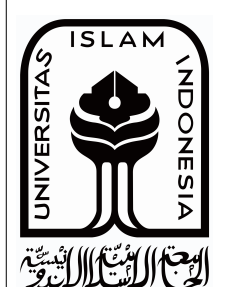

PROYEK AKHIR SARJANA  
  
BANDUNG CULTURE AND TOURISM CENTER

DIBUAT OLEH :

NAMA :	NIM :
FREDY MAHENDRA	14 512 139
PEMBIMBING :	M. Galieh Gunagama, S.T., M.Sc.
PENGUJI :	Dr. Ir. Sugini, M.T., IAI

NAMA GAMBAR :  
Rencana Keselamatan  
JUDUL GAMBAR :  
-1. Story

Hlm :  
A.01.9  
SKALA :  
1:350

NO.	TANGGAL :

CATATAN / REVISI :

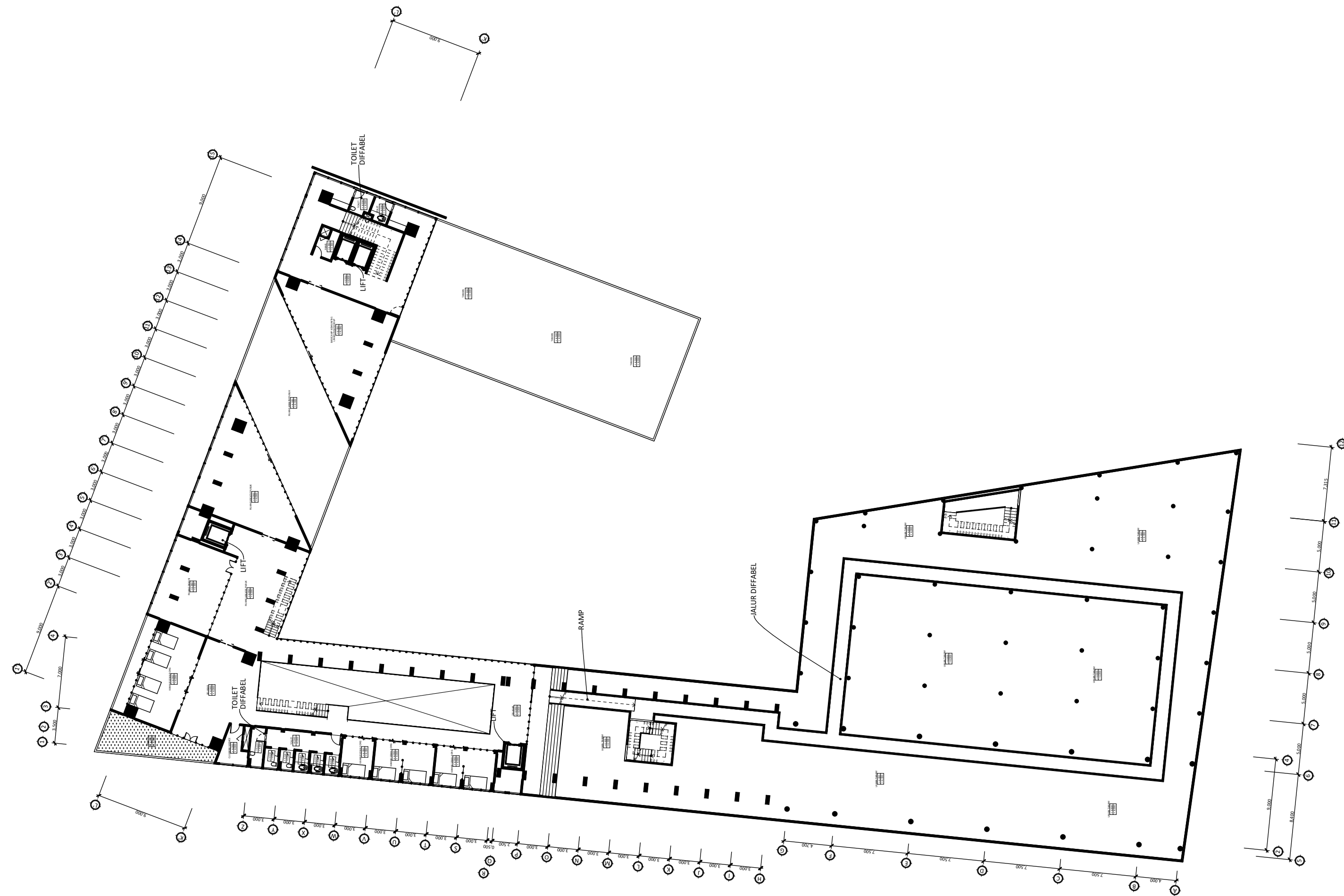

**SKEMA BARRIER FREE**  
*lantai typical*  
 1 : 350

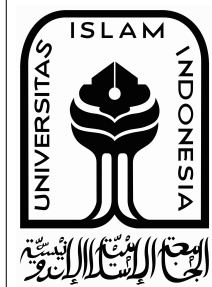

PROYEK AKHIR SARJANA  
 BANDUNG CULTURE AND TOURISM CENTER

DIBUAT OLEH :

NAMA :	NIM :
FREDY MAHENDRA	14 512 139
PEMBIMBING :	M. Galieh Gunagama, S.T., M.Sc.
PENGUJI :	Dr. Ir. Sugini, M.T., IAI

NAMA GAMBAR :  
 Rencana Barrier Free  
 JUDUL GAMBAR :  
 1. Story

Hlm :  
 A.01.10  
 SKALA :  
 1:350

DISETUJUI : NO. TANGGAL :

CATATAN / REVISI :

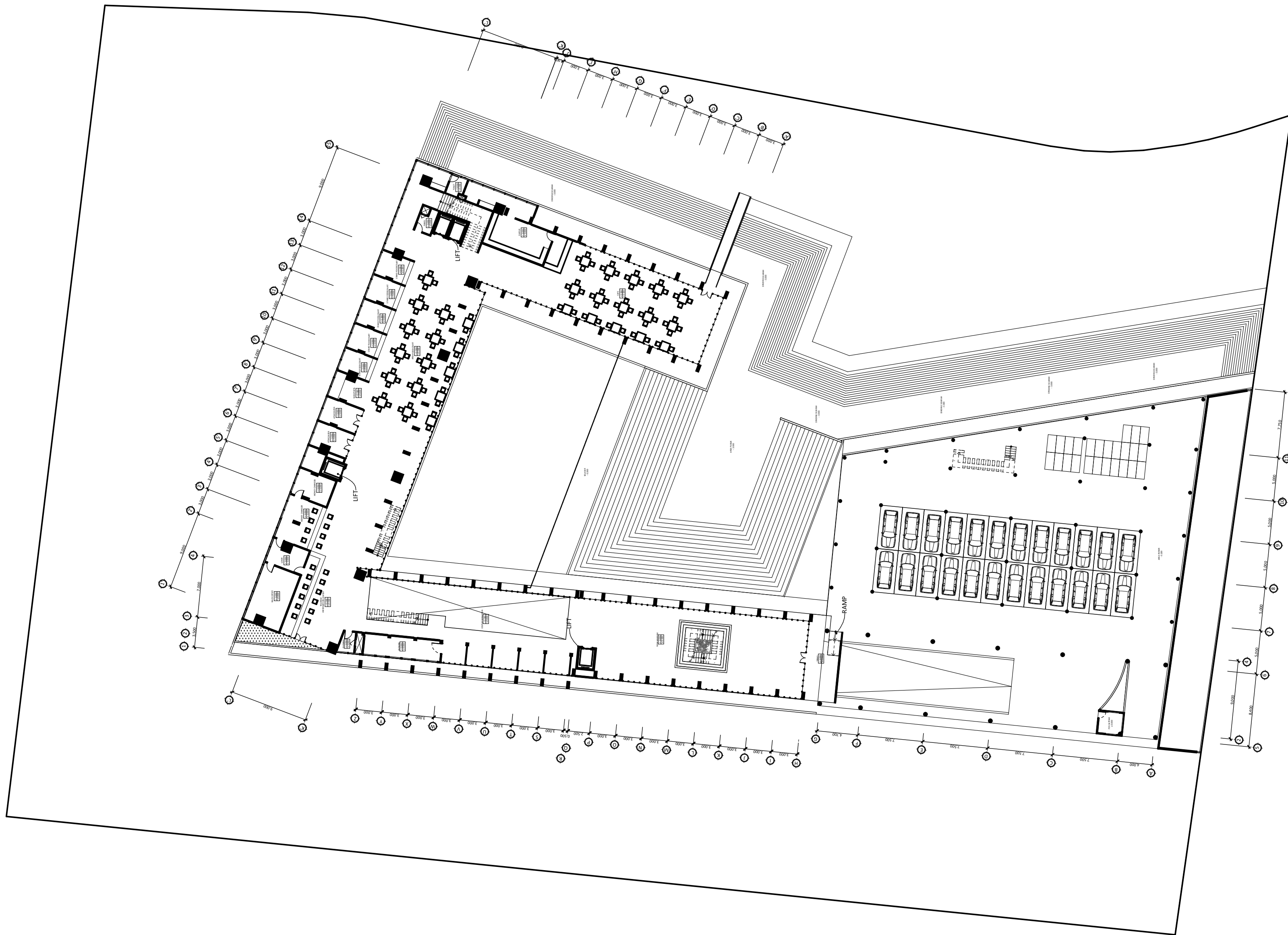

**SKEMA BARRIER FREE**  
*lantai dasar*  
 1 : 350

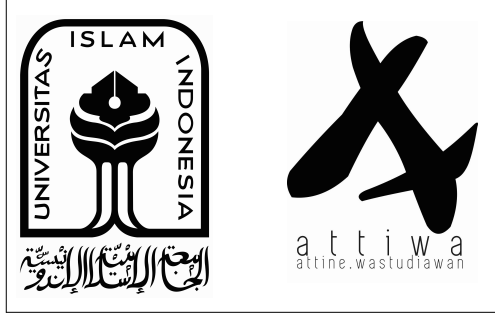

PROYEK AKHIR SARJANA		DIBUAT OLEH :		NAMA GAMBAR :		Hlm :	DISETUJUI :	NO.	TANGGAL :	CATATAN / REVISI :
BANDUNG CULTURE AND TOURISM CENTER		NAMA :		Rencana Barrier Free		A.01.10				
		FREDY MAHENDRA		14 512 139		JUDUL GAMBAR :	SKALA :			
		PEMBIMBING :	M. Galieh Gunagama, S.T., M.Sc.		0. Ground Floor		1:350			
		PENGUJI :	Dr. Ir. Sugini, M.T., IAI							

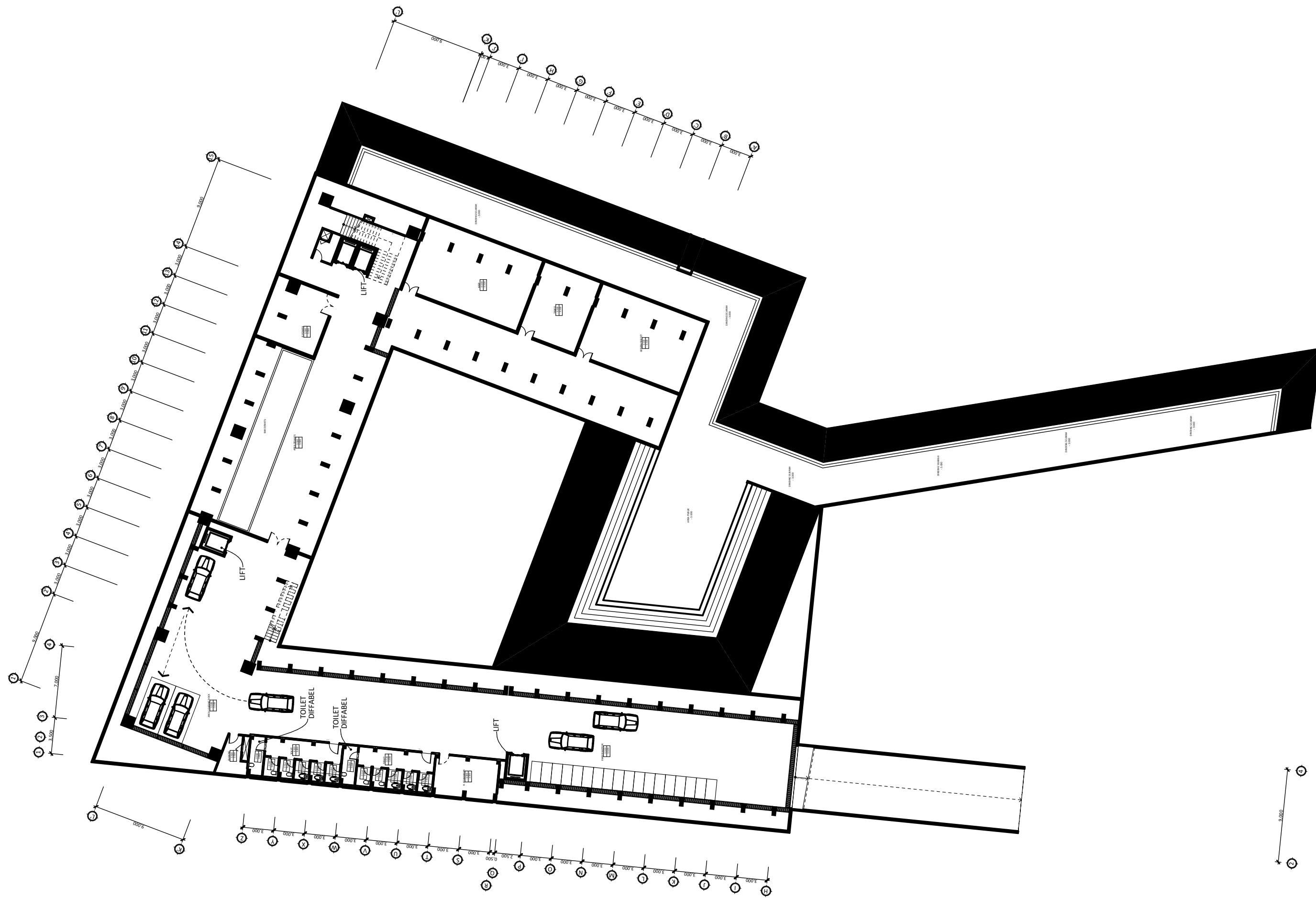

**SKEMA BARRIER FREE**  
*lantai basement*  
 1 : 350

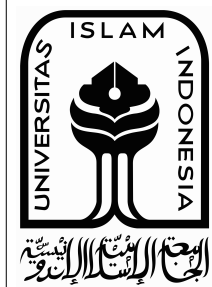

PROYEK AKHIR SARJANA  
 BANDUNG CULTURE AND TOURISM CENTER

DIBUAT OLEH :

NAMA :	NIM :
FREDY MAHENDRA	14 512 139
PEMBIMBING :	M. Galieh Gunagama, S.T., M.Sc.
PENGUJI :	Dr. Ir. Sugini, M.T., IAI

NAMA GAMBAR :  
 Rencana Barrier Free  
 A.01.10  
 JUDUL GAMBAR :  
 -1. Story

Hlm :  
 SKALA :  
 1:350

NO.	TANGGAL :

CATATAN / REVISI :



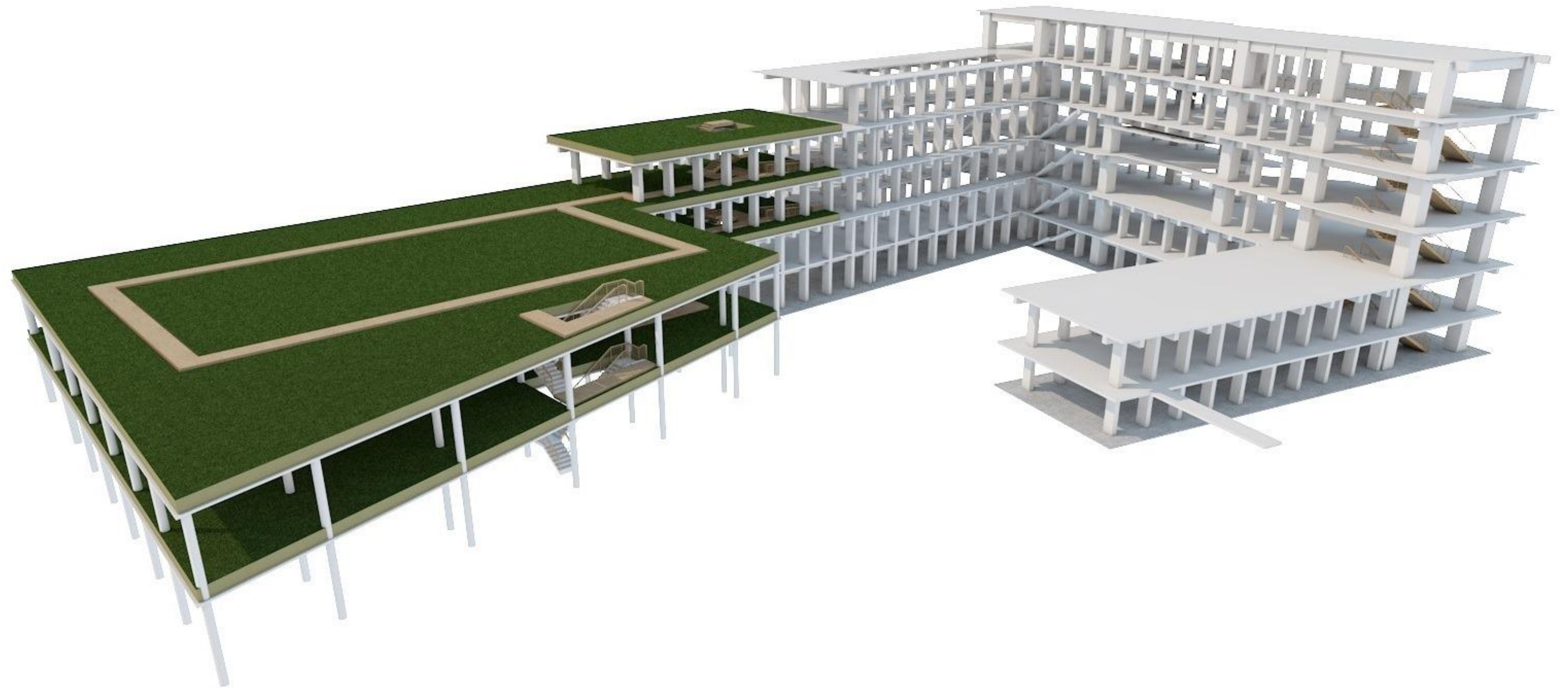

**RENCANA STRUKTUR**  
*skema 3 dimensi*  
 NTS

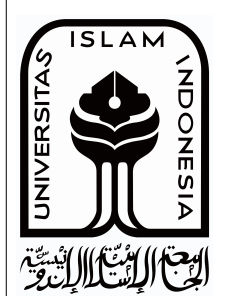

PROYEK AKHIR SARJANA  BANDUNG CULTURE AND TOURISM CENTER	DIBUAT OLEH :		NAMA GAMBAR :		Hlm :	DISETUJUI :	NO.	TANGGAL :	CATATAN / REVISI :
	NAMA :	NIM :	Rencana Struktur	A.01.8					
	FREDY MAHENDRA	14 512 139	JUDUL GAMBAR :		SKALA :				
	PEMBIMBING :	M. Galieh Gunagama, S.T., M.Sc.	0. Skema Struktur						
	PENGUJI :	Dr. Ir. Sugini, M.T., IAI							

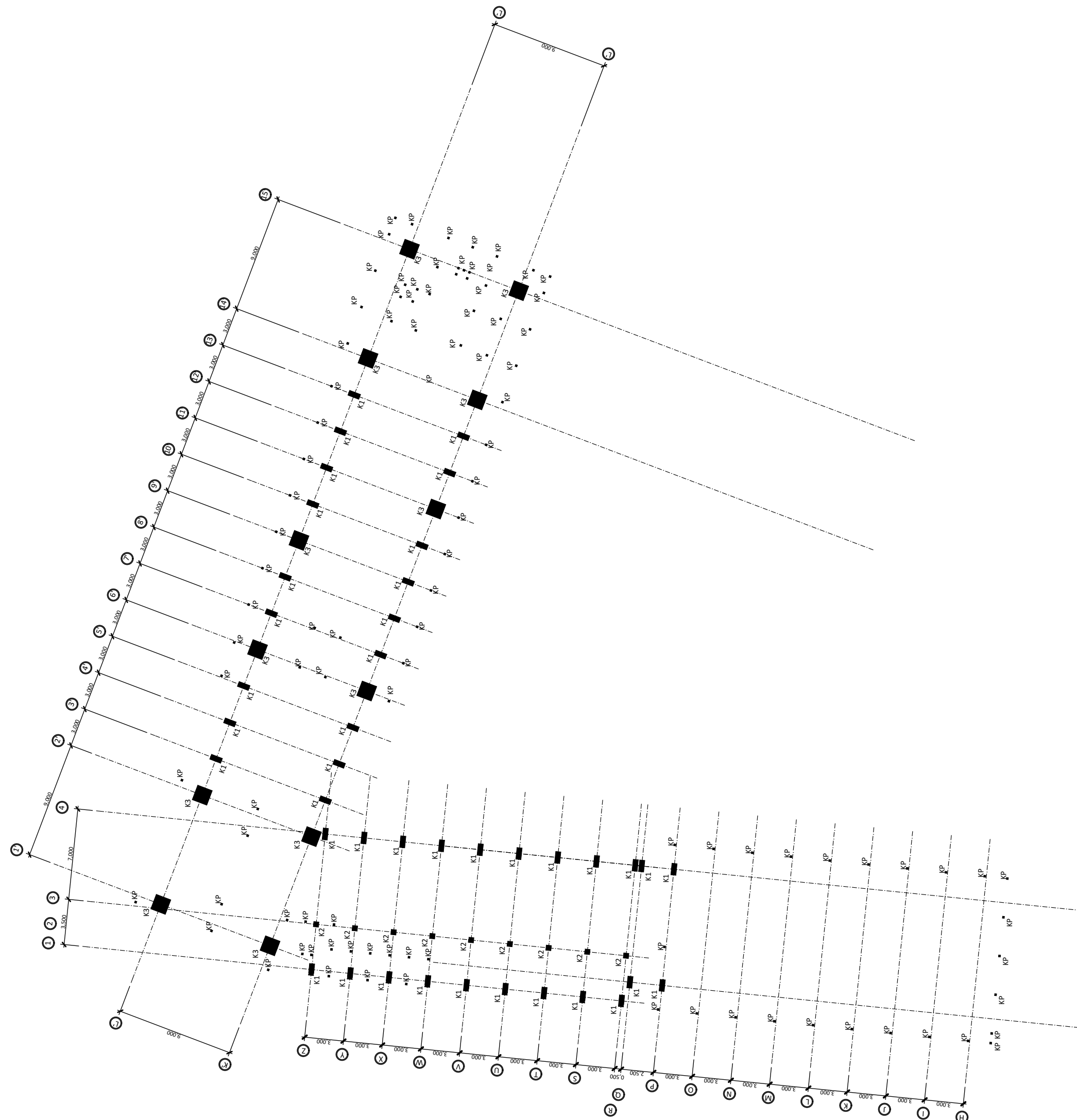

**RENCANA KOLOM**  
*lantai 3*  
 1 : 300

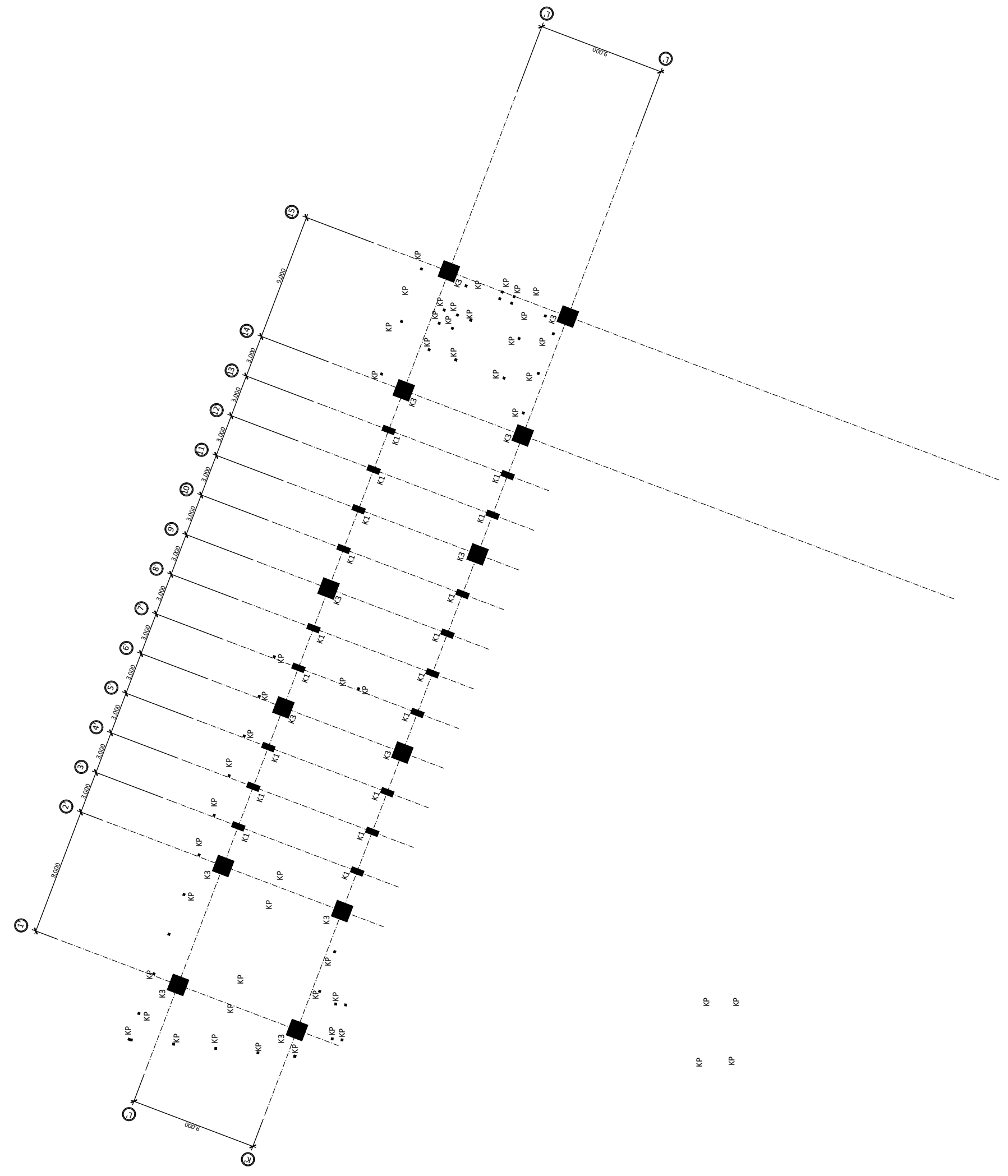

**RENCANA KOLOM**  
*lantai 4*  
 1 : 300

- K1 : kolom beton 400x900 mm
- K2 : kolom beton 400x400 mm
- K3 : kolom beton 1200x1200 mm
- K4 : kolom beton ø 500 mm
- KP : kolom praktis 150x150 mm



PROYEK AKHIR SARJANA  
 BANDUNG CULTURE AND TOURISM CENTER

DIBUAT OLEH :	
NAMA :	NIM :
FREDY MAHENDRA	14 512 139
PEMBIMBING :	M. Galieh Gunagama, S.T., M.Sc.
PENGUJI :	Dr. Ir. Sugini, M.T., IAI

NAMA GAMBAR :	Hlm :	DISETUJUI :	NO.	TANGGAL :	CATATAN / REVISI :
Rencana Kolom	A.01.8.1				
JUDUL GAMBAR :	SKALA :				
3. Story	1:300				

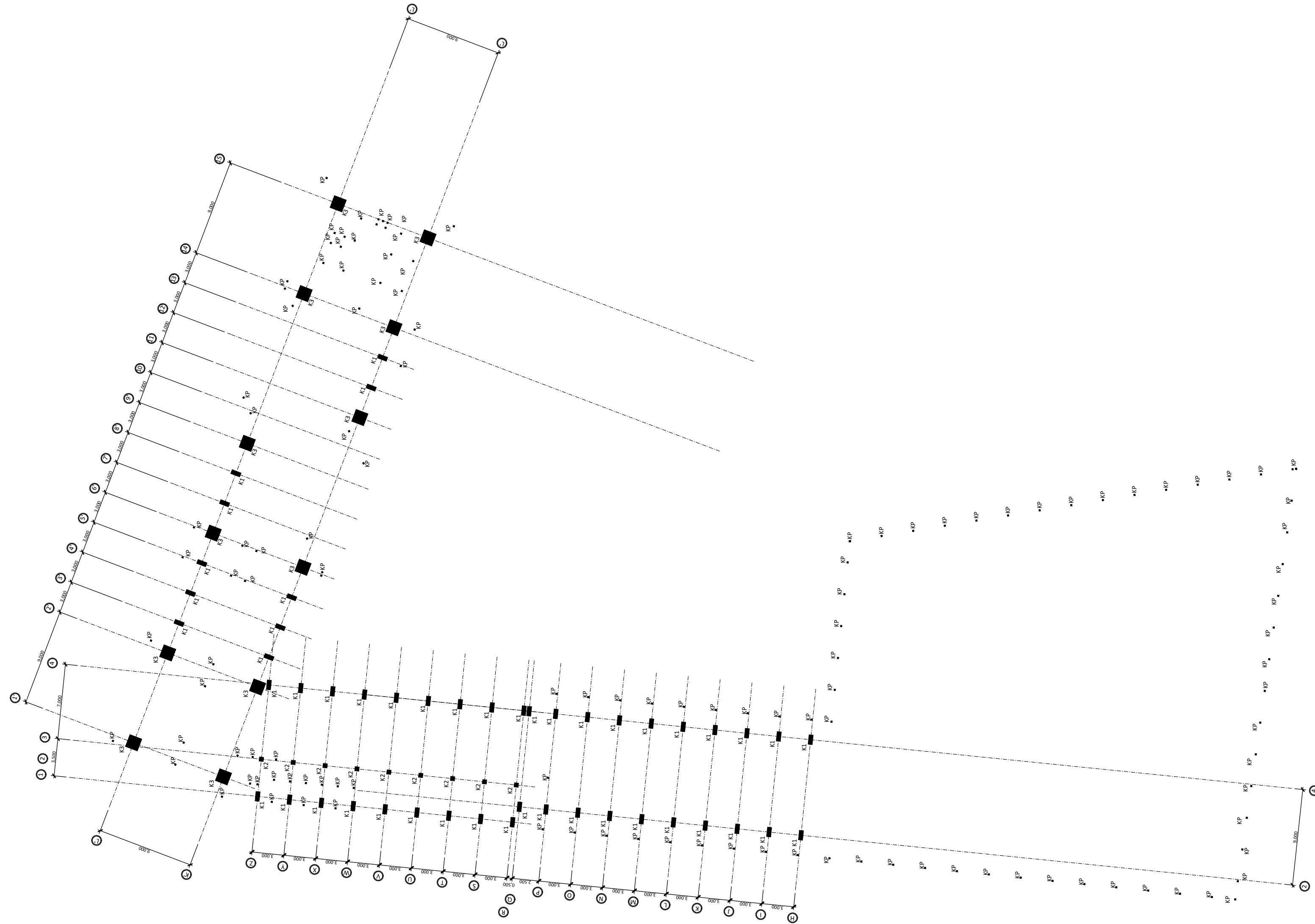



- K1 : kolom beton 400x900 mm
- K2 : kolom beton 400x400 mm
- K3 : kolom beton 1200x1200 mm
- K4 : kolom beton ø 500 mm
- KP : kolom praktis 150x150 mm

## RENCANA KOLOM

lantai 2

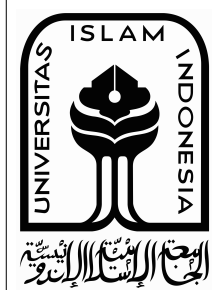
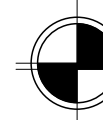
1 : 300



PROYEK AKHIR SARJANA

BANDUNG CULTURE AND TOURISM CENTER

DIBUAT OLEH :

NAMA :

NIM :

FREDY MAHENDRA

14 512 139

PEMBIMBING :

M. Galieh Gunagama, S.T., M.Sc.

PENGUJI :

Dr. Ir. Sugini, M.T., IAI

NAMA GAMBAR :

Rencana Kolom

A.01.8.1

JUDUL GAMBAR :

2. Story

Hlm :

SKALA :

1:300

DISETUJUI :

NO.

TANGGAL :

CATATAN / REVISI :

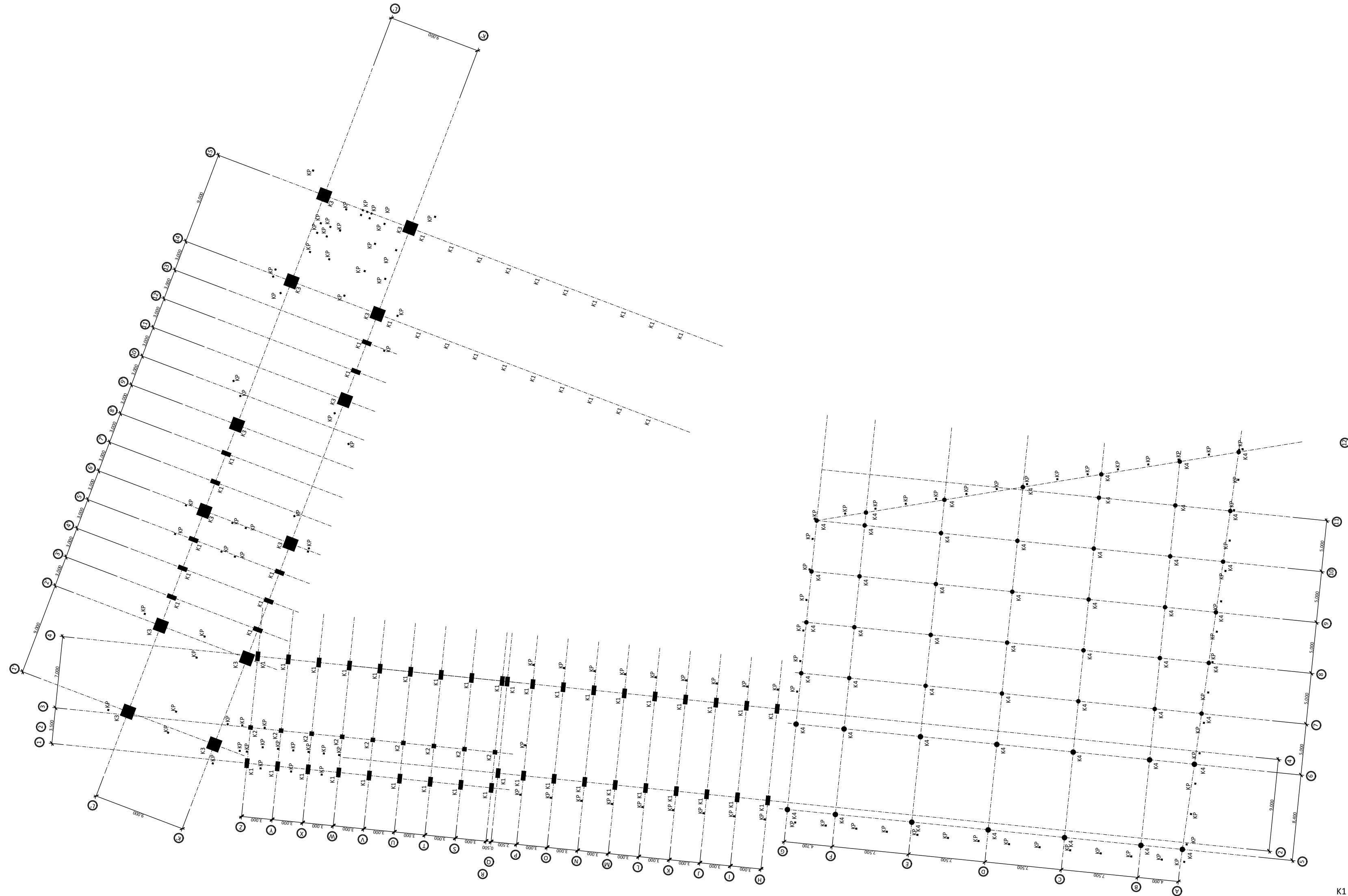

- K1 : kolom beton 400x900 mm
- K2 : kolom beton 400x400 mm
- K3 : kolom beton 1200x1200 mm
- K4 : kolom beton  $\phi$  500 mm
- KP : kolom praktis 150x150 mm

## RENCANA KOLOM

lantai 1

1 : 300

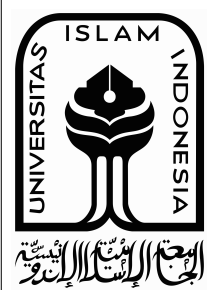
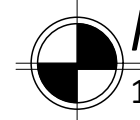

PROYEK AKHIR SARJANA

BANDUNG CULTURE AND TOURISM CENTER

DIBUAT OLEH :

NAMA :

NIM :

FREDY MAHENDRA

14 512 139

PEMBIMBING :

M. Galieh Gunagama, S.T., M.Sc.

PENGUJI :

Dr. Ir. Sugini, M.T., IAI

NAMA GAMBAR :

Rencana Kolom

A.01.8.1

JUDUL GAMBAR :

1. Story

Hlm :

SKALA :

1:300

DISETUJUI :

NO.

TANGGAL :

CATATAN / REVISI :



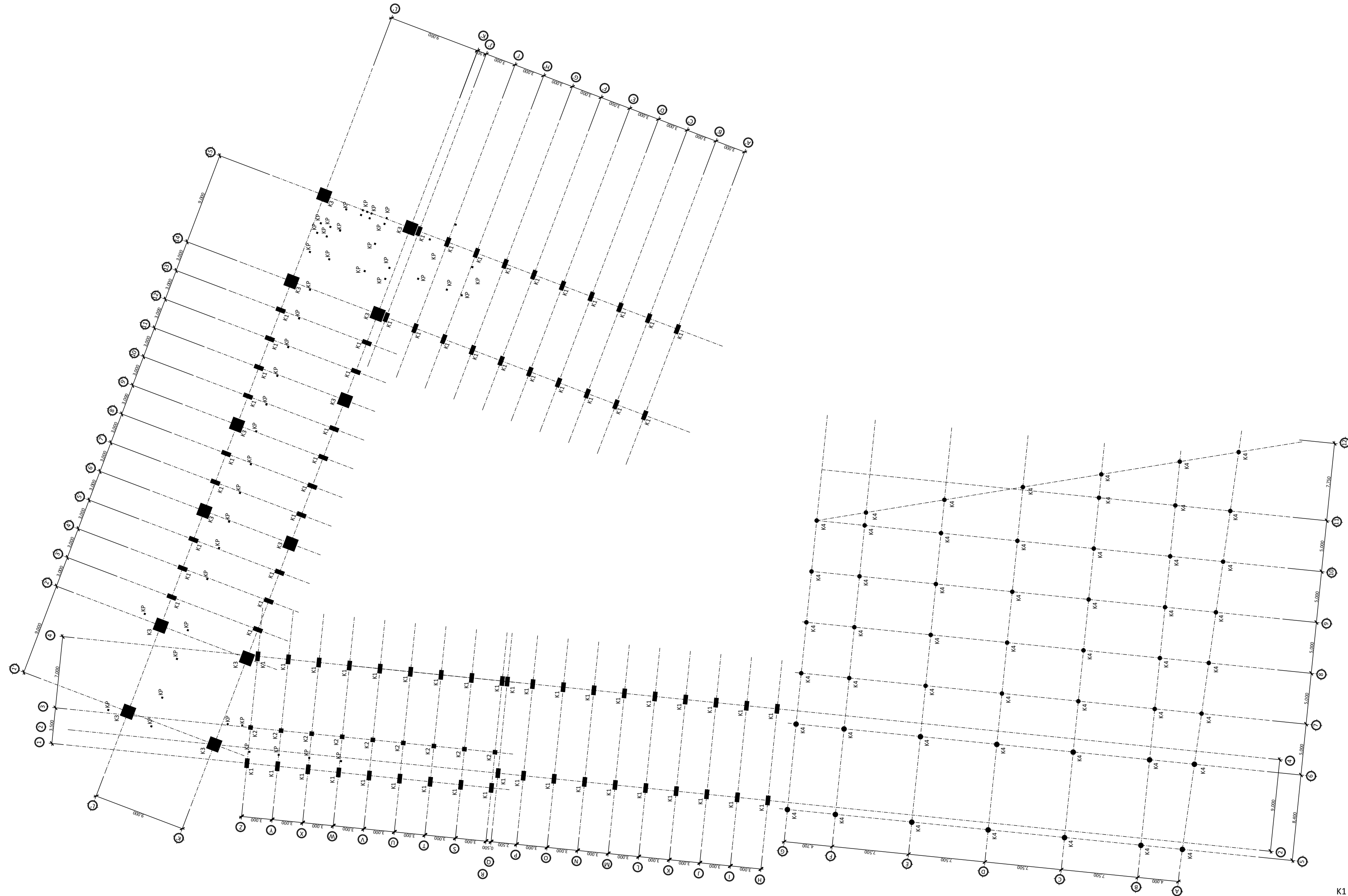

- K1 : kolom beton 400x900 mm
- K2 : kolom beton 400x400 mm
- K3 : kolom beton 1200x1200 mm
- K4 : kolom beton  $\phi$  500 mm
- KP : kolom praktis 150x150 mm

## RENCANA KOLOM

*lantai dasar*

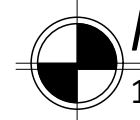

1 : 300

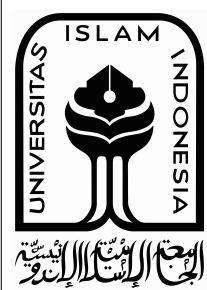

PROYEK AKHIR SARJANA

BANDUNG CULTURE AND TOURISM CENTER

DIBUAT OLEH :

NAMA :

NIM :

FREDY MAHENDRA

14 512 139

PEMBIMBING :

M. Galieh Gunagama, S.T., M.Sc.

PENGUJI :

Dr. Ir. Sugini, M.T., IAI

NAMA GAMBAR :

Rencana Kolom

A.01.8.1

JUDUL GAMBAR :

0. Ground Floor

Hlm :

SKALA :

1:300

DISETUJUI :

NO.

TANGGAL :

CATATAN / REVISI :

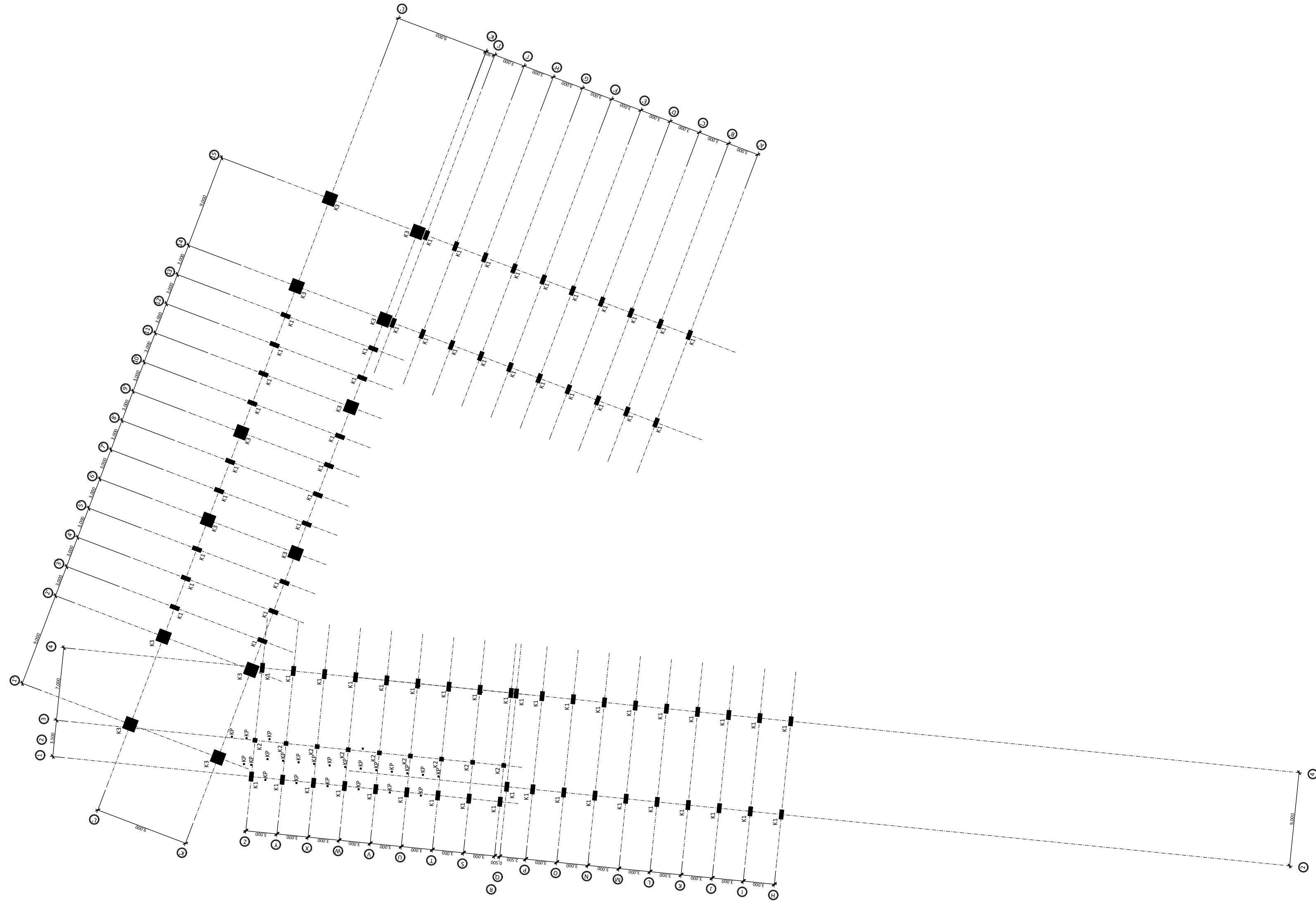

- K1 : kolom beton 400x900 mm
- K2 : kolom beton 400x400 mm
- K3 : kolom beton 1200x1200 mm
- K4 : kolom beton  $\phi$  500 mm
- KP : kolom praktis 150x150 mm

**RENCANA KOLOM**  
*lantai basement*

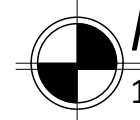

1 : 300

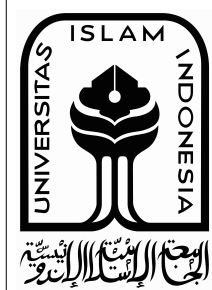

PROYEK AKHIR SARJANA

BANDUNG CULTURE AND TOURISM CENTER

DIBUAT OLEH :

NAMA :

NIM :

FREDY MAHENDRA

14 512 139

PEMBIMBING :

M. Galieh Gunagama, S.T., M.Sc.

PENGUJI :

Dr. Ir. Sugini, M.T., IAI

NAMA GAMBAR :

Rencana Kolom

A.01.8.1

JUDUL GAMBAR :

-1. Story

Hlm :

SKALA :

1:300

DISETUJUI :

NO.

TANGGAL :

CATATAN / REVISI :



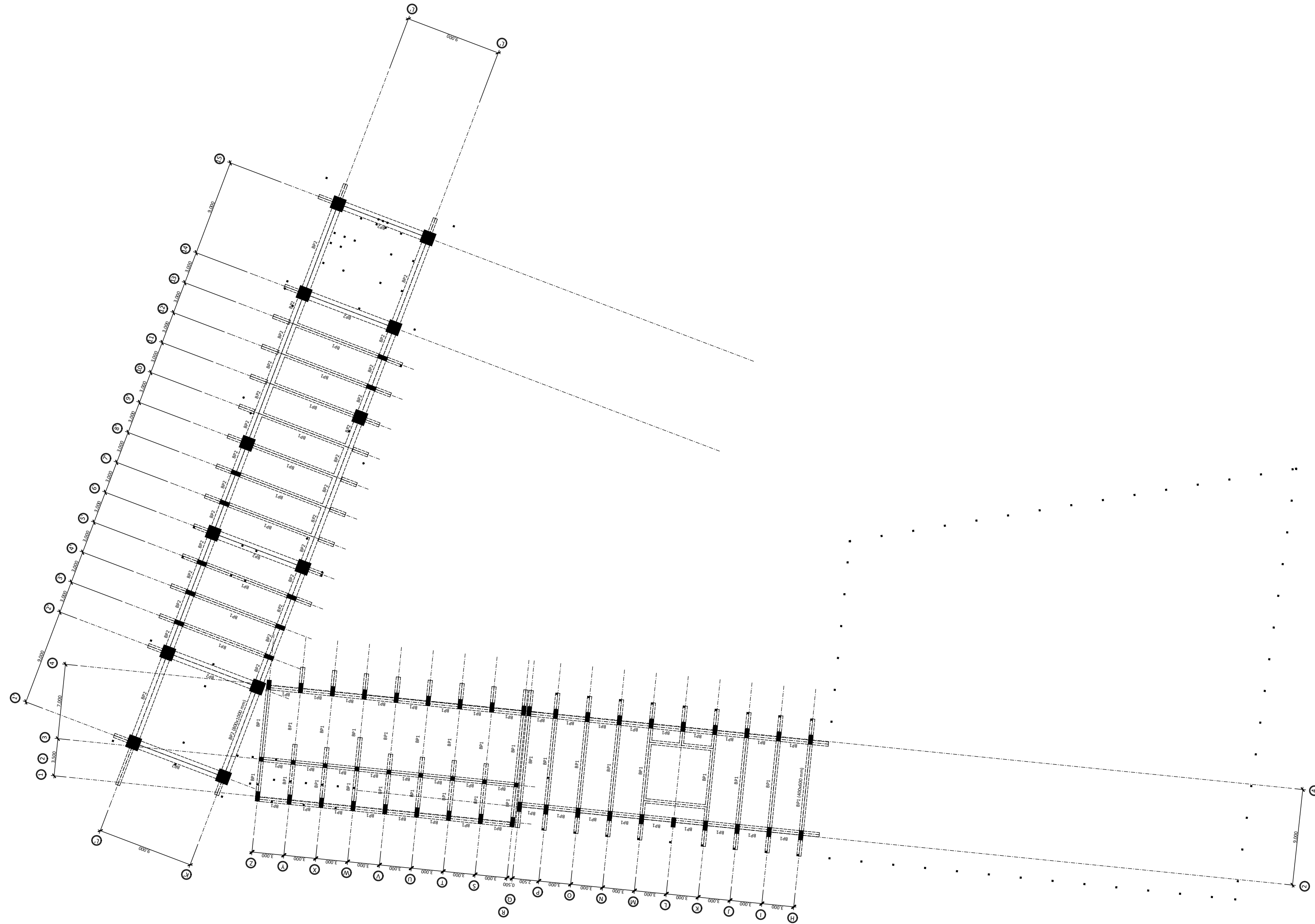

BP1 : balok portal beton 400x600 mm  
 BP2 : balok portal beton 800x1200 mm  
 BP3 : balok portal beton 300x400 mm

## RENCANA BALOK

*lantai 2*

1 : 300

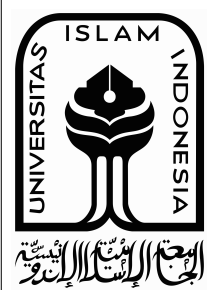
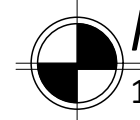

PROYEK AKHIR SARJANA

BANDUNG CULTURE AND TOURISM CENTER

DIBUAT OLEH :

NAMA :

NIM :

FREDY MAHENDRA

14 512 139

PEMBIMBING :

M. Galieh Gunagama, S.T., M.Sc.

PENGUJI :

Dr. Ir. Sugini, M.T., IAI

NAMA GAMBAR :

Rencana Balok

A.01.8.2

JUDUL GAMBAR :

2. Story

Hlm :

SKALA :

1:300

DISETUJUI :

NO.

TANGGAL :

CATATAN / REVISI :



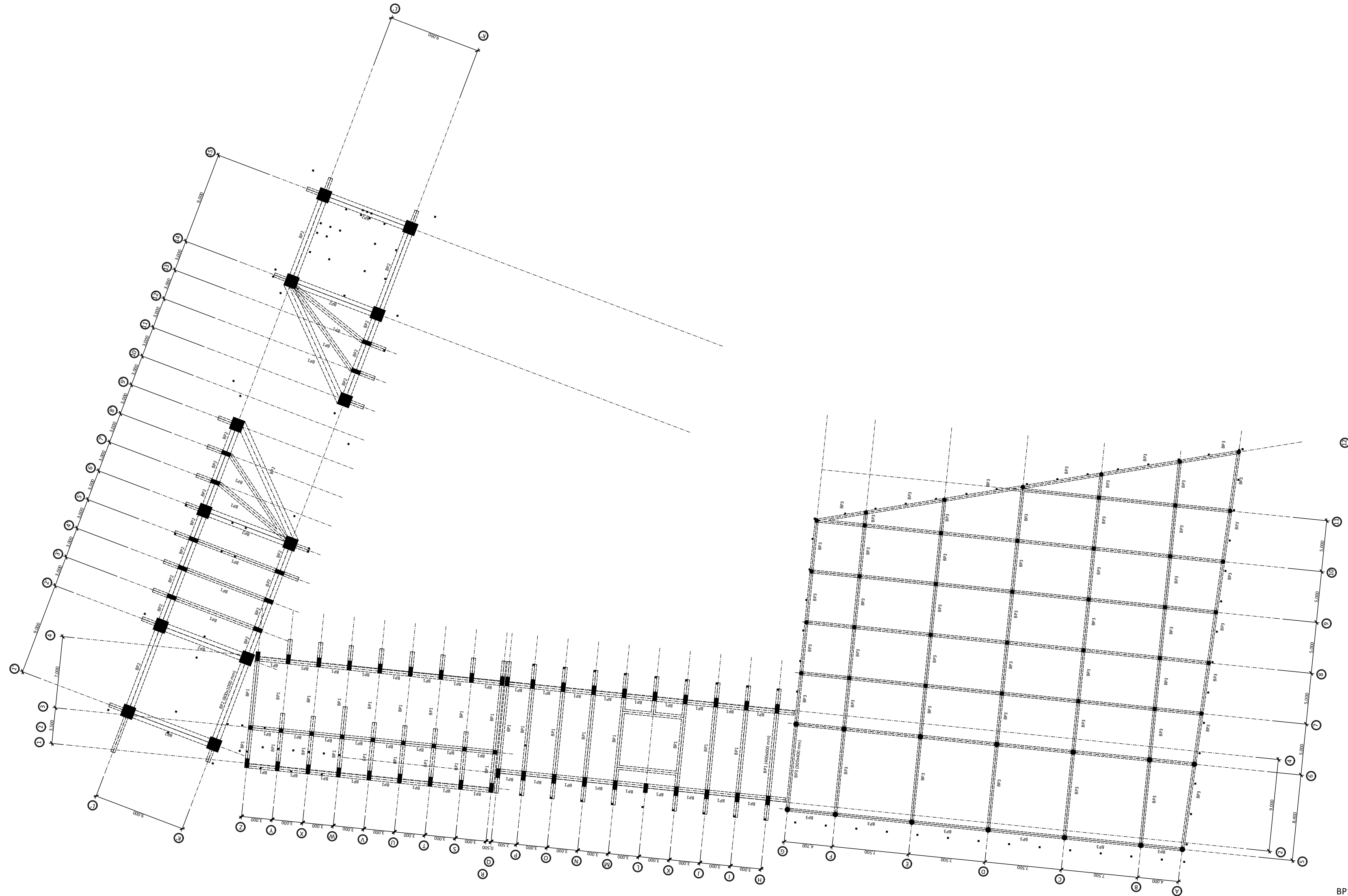

- BP1 : balok portal beton 400x600 mm
- BP2 : balok portal beton 800x1200 mm
- BP3 : balok portal beton 300x400 mm

## RENCANA BALOK

*lantai 1*

1 : 300

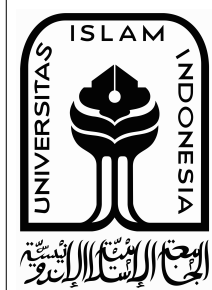

PROYEK AKHIR SARJANA  
BANDUNG CULTURE AND TOURISM CENTER

DIBUAT OLEH :

NAMA :

NIM :

FREDY MAHENDRA

14 512 139

PEMBIMBING :

M. Galieh Gunagama, S.T., M.Sc.

PENGUJI :

Dr. Ir. Sugini, M.T., IAI

NAMA GAMBAR :

Rencana Balok

A.01.8.2

JUDUL GAMBAR :

1. Story

Hlm :

SKALA :

1:300

DISETUJUI :

NO.

TANGGAL :

CATATAN / REVISI :

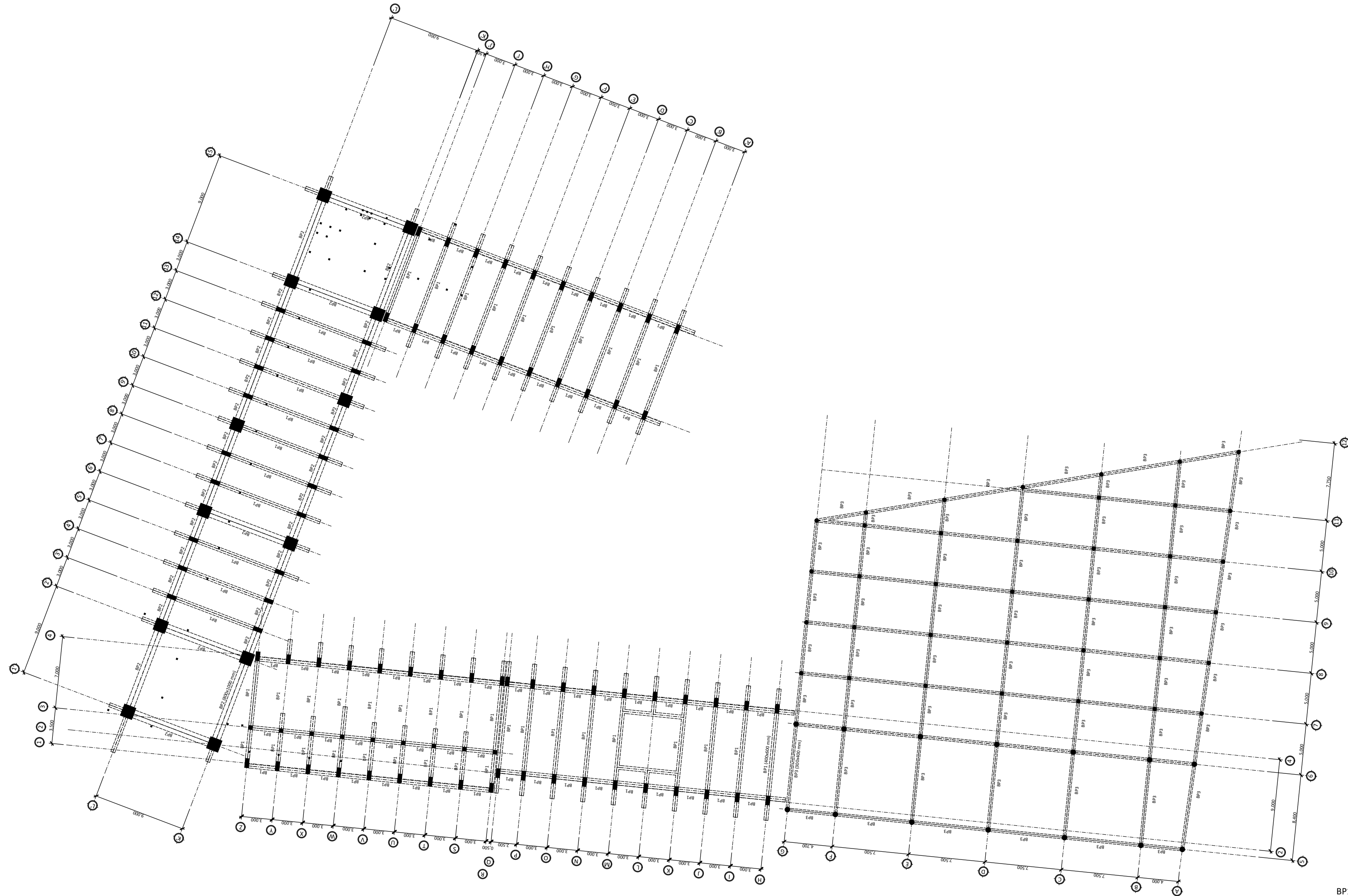

BP1 : balok portal beton 400x600 mm  
 BP2 : balok portal beton 800x1200 mm  
 BP3 : balok portal beton 300x400 mm

**RENCANA BALOK**

*lantai dasar*

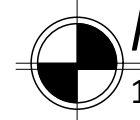

1 : 300

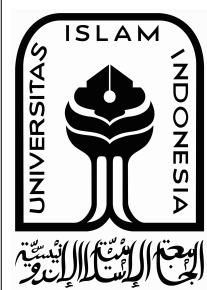

PROYEK AKHIR SARJANA  
 BANDUNG CULTURE AND TOURISM CENTER

DIBUAT OLEH :  
 NAMA : FREDY MAHENDRA  
 NIM : 14 512 139  
 PEMBIMBING : M. Galieh Gunagama, S.T., M.Sc.  
 PENGUJI : Dr. Ir. Sugini, M.T., IAI

NAMA GAMBAR : Rencana Balok  
 A.01.8.2  
 JUDUL GAMBAR : 0. Ground Floor

Hlm :  
 DISETUJUI :  
 NO. :  
 TANGGAL :  
 SKALA : 1:300

CATATAN / REVISI :

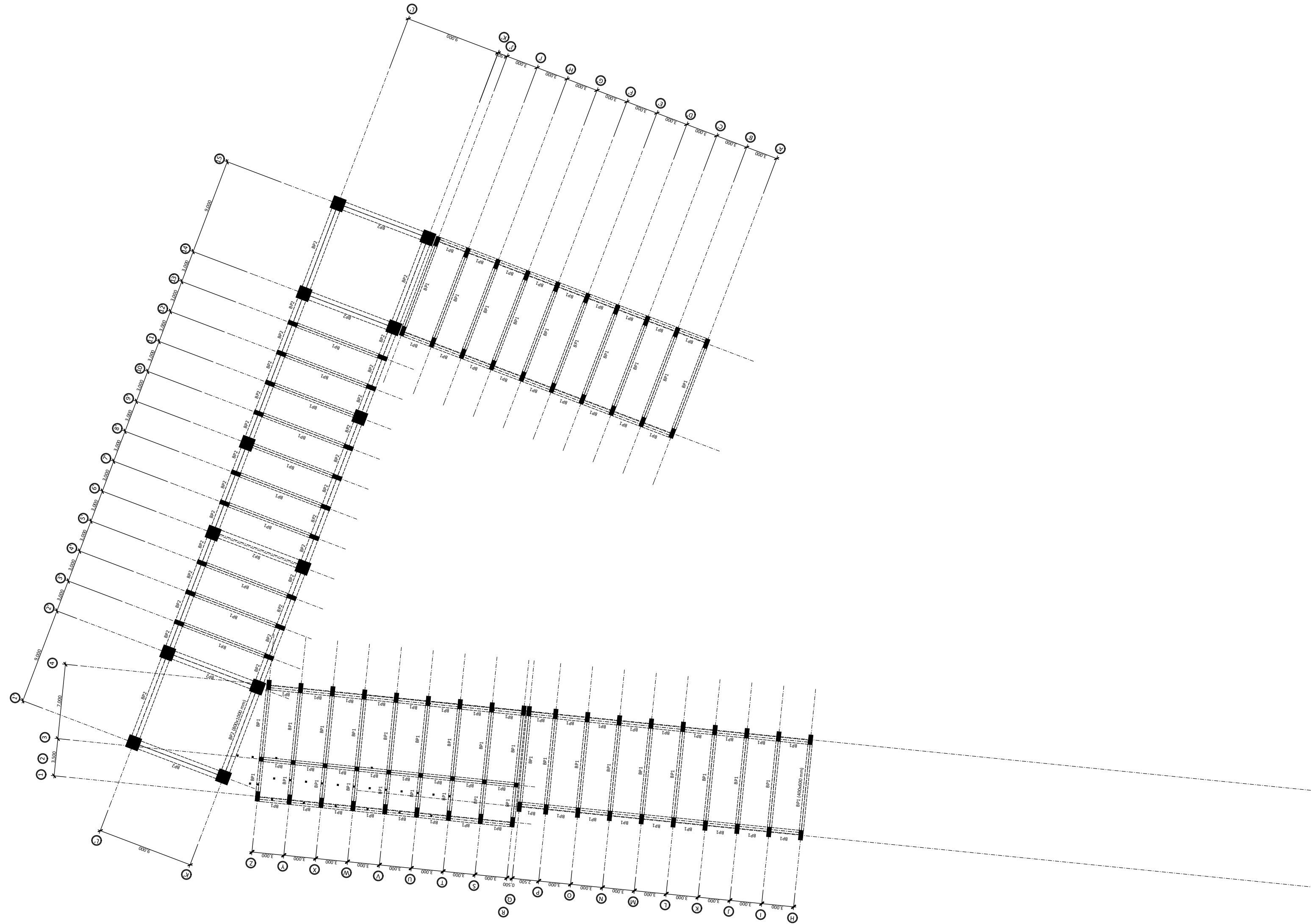

BP1 : balok portal beton 400x600 mm  
 BP2 : balok portal beton 800x1200 mm  
 BP3 : balok portal beton 300x400 mm

**RENCANA BALOK**  
*lantai basement*  
 1 : 300

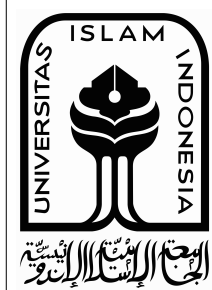

PROYEK AKHIR SARJANA  
 BANDUNG CULTURE AND TOURISM CENTER

DIBUAT OLEH :

NAMA :

NIM :

FREDY MAHENDRA

14 512 139

PEMBIMBING :

M. Galieh Gunagama, S.T., M.Sc.

PENGUJI :

Dr. Ir. Sugini, M.T., IAI

NAMA GAMBAR :

Rencana Balok

JUDUL GAMBAR :

-1. Story

Hlm :

A.01.8.2

SKALA :

1:300

DISETUJUI :

NO.

TANGGAL :

CATATAN / REVISI :

NO.	TANGGAL	CATATAN / REVISI

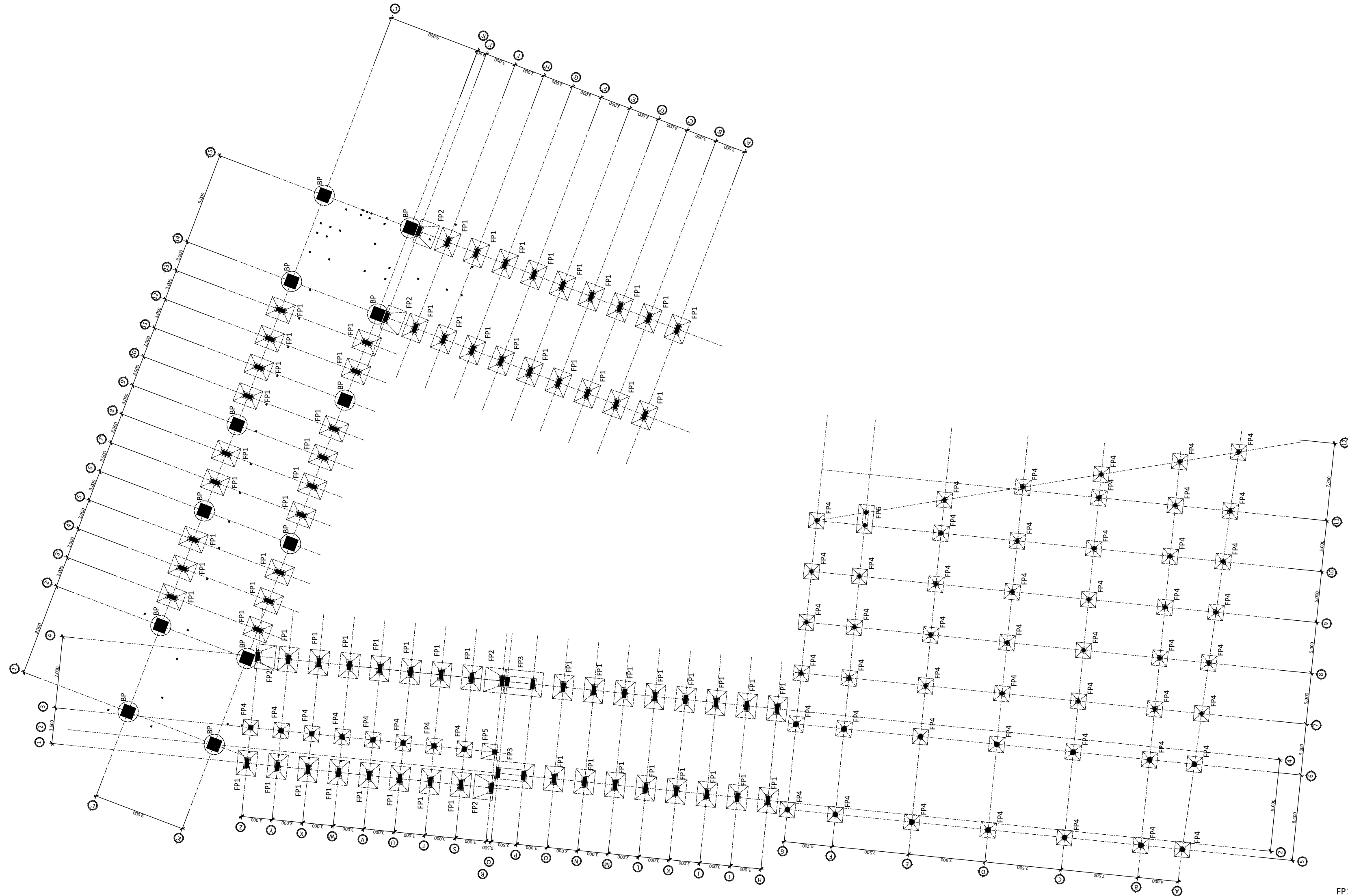

- FP1 : pondasi footplat beton 1900x2400 mm
- FP2 : pondasi footplat beton 1900x2400 mm
- FP3 : pondasi footplat beton 2400x3650 mm
- FP4 : pondasi footplat beton 1500x1500 mm
- FP5 : pondasi footplat beton 1500x1500 mm
- FP6 : pondasi footplat beton 1500x2800 mm
- BP : pondasi bored pile beton  $\phi$  2000 mm

**RENCANA PONDASI**  
 1 : 300

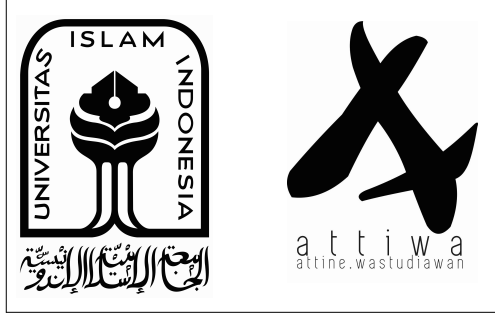

PROYEK AKHIR SARJANA  
  
**BANDUNG CULTURE AND TOURISM CENTER**

DIBUAT OLEH :  
 NAMA : FREDY MAHENDRA  
 NIM : 14 512 139  
 PEMBIMBING : M. Galieh Gunagama, S.T., M.Sc.  
 PENGUJI : Dr. Ir. Sugini, M.T., IAI

NAMA GAMBAR : Rencana Pondasi  
 JUDUL GAMBAR : 0. Ground Floor  
 Hlm : A.01.8.3  
 SKALA : 1:300

DISETUJUI :	NO.	TANGGAL :	CATATAN / REVISI :



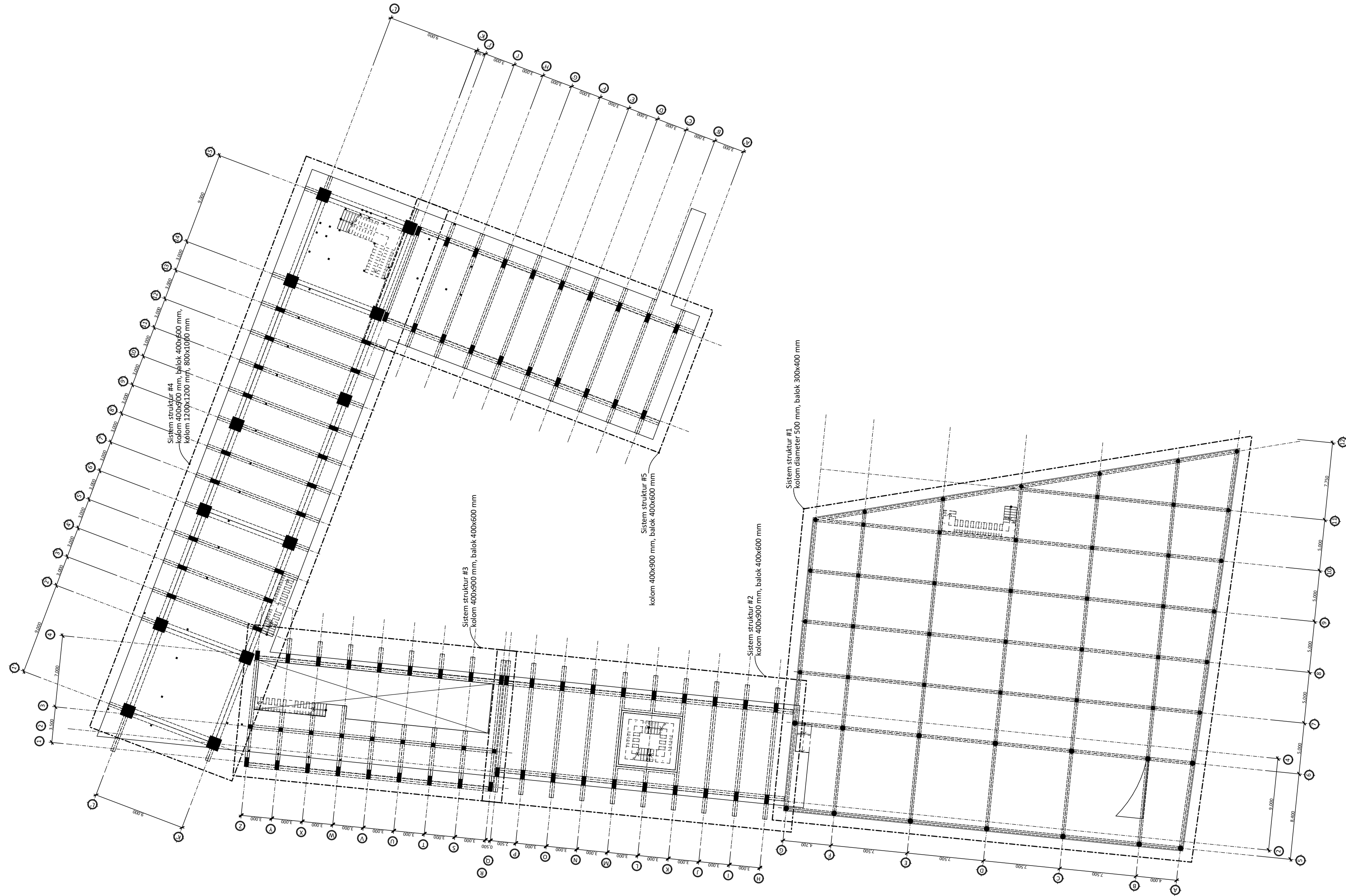

**RENCANA STRUKTUR**

*sistem delatasi*

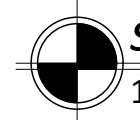

1 : 300

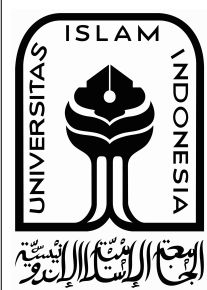

PROYEK AKHIR SARJANA

BANDUNG CULTURE AND TOURISM CENTER

DIBUAT OLEH :

NAMA :

NIM :

FREDY MAHENDRA

14 512 139

PEMBIMBING :

M. Galieh Gunagama, S.T., M.Sc.

PENGUJI :

Dr. Ir. Sugini, M.T., IAI

NAMA GAMBAR :

Rencana Struktur

A.01.8

JUDUL GAMBAR :

0. Skema Struktur

Hlm :

SKALA :

1:300

DISETUJUI :

NO.

TANGGAL :

CATATAN / REVISI :

NO.	TANGGAL	CATATAN / REVISI

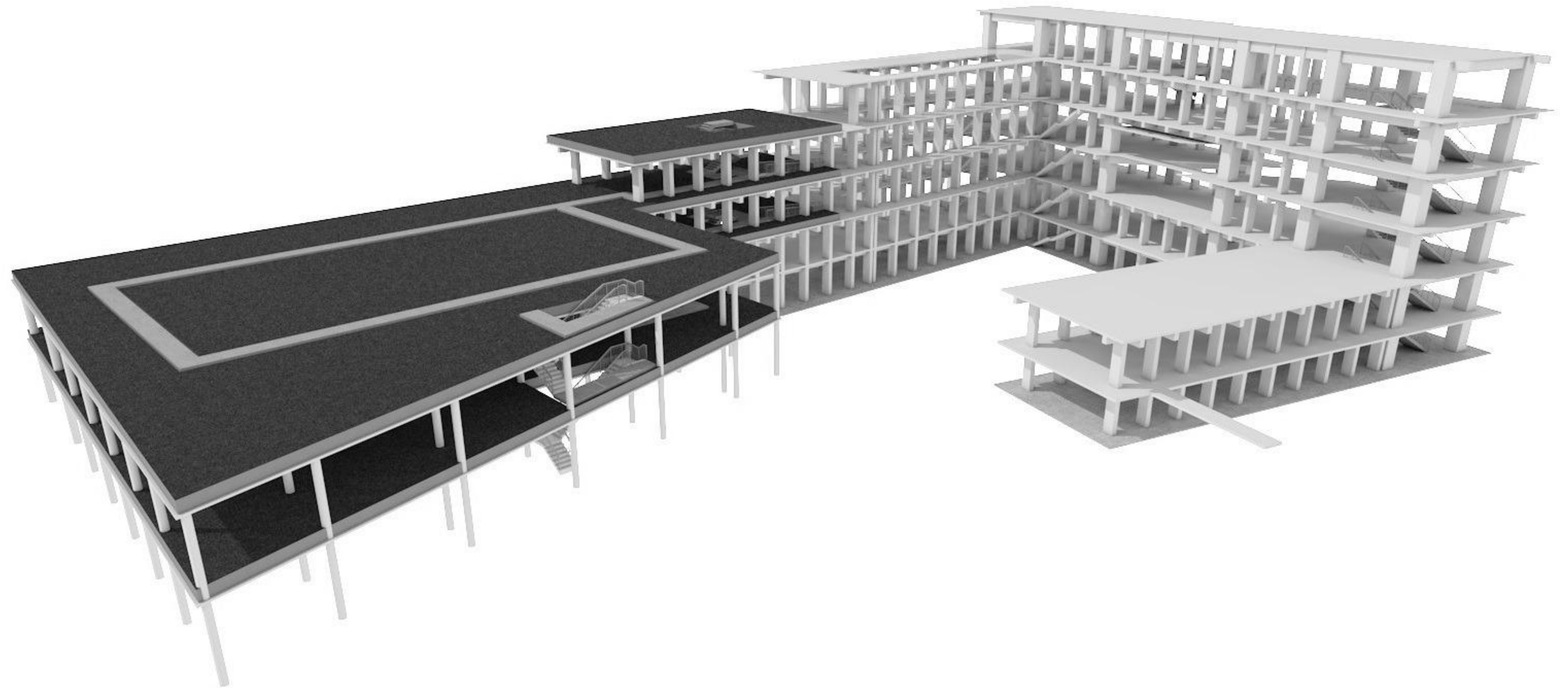

**RENCANA STRUKTUR**  
*skema 3 dimensi*  
 NTS

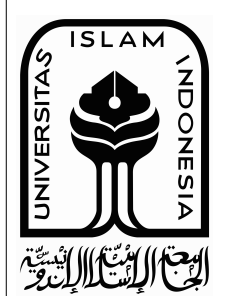

PROYEK AKHIR SARJANA

BANDUNG CULTURE AND TOURISM CENTER

DIBUAT OLEH :

NAMA : FREDY MAHENDRA  
 NIM : 14 512 139

PEMBIMBING : M. Galieh Gunagama, S.T., M.Sc.  
 PENGUJI : Dr. Ir. Sugini, M.T., IAI

NAMA GAMBAR : Rencana Struktur  
 Hlm : A.01.8

JUDUL GAMBAR : 0. Skema Struktur  
 SKALA :

DISETUJUI :  
 NO. :  
 TANGGAL :

CATATAN / REVISI :



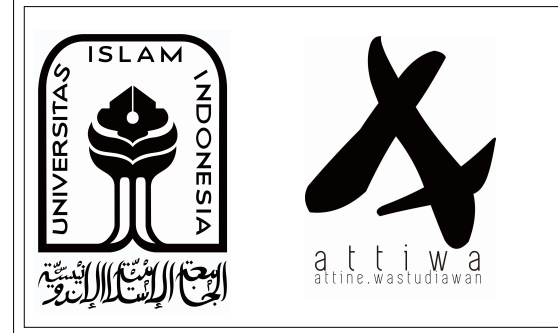
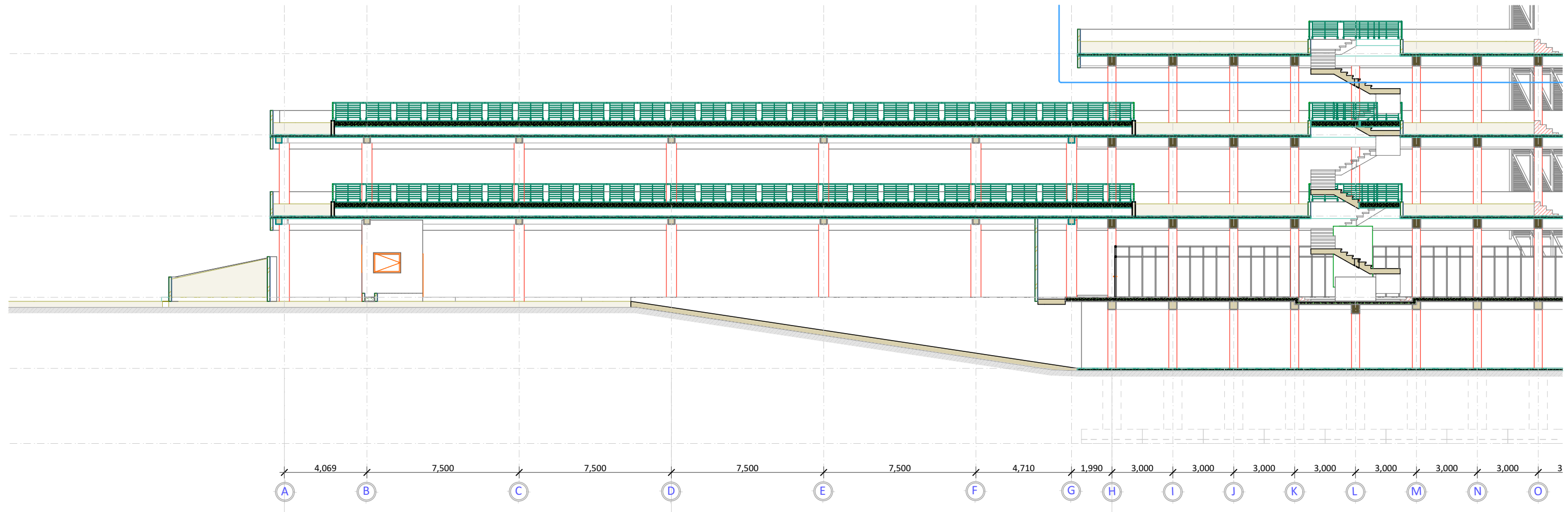
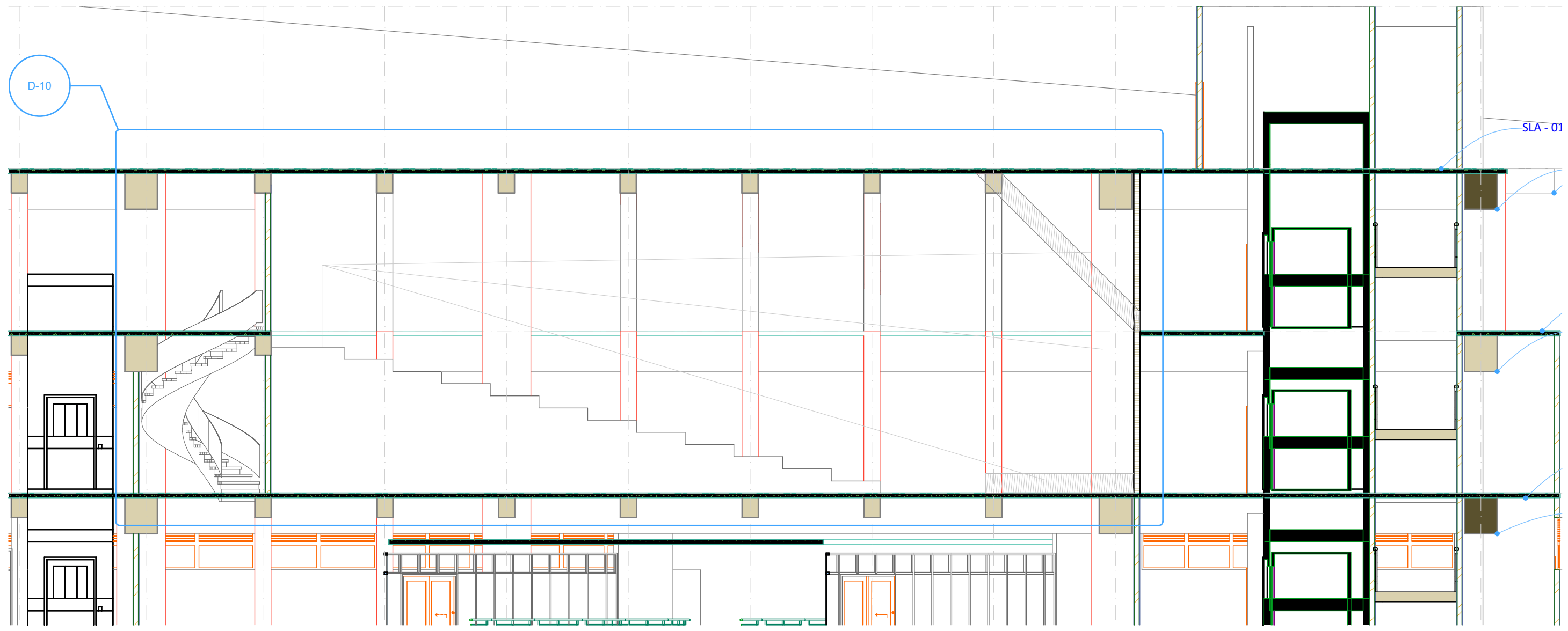
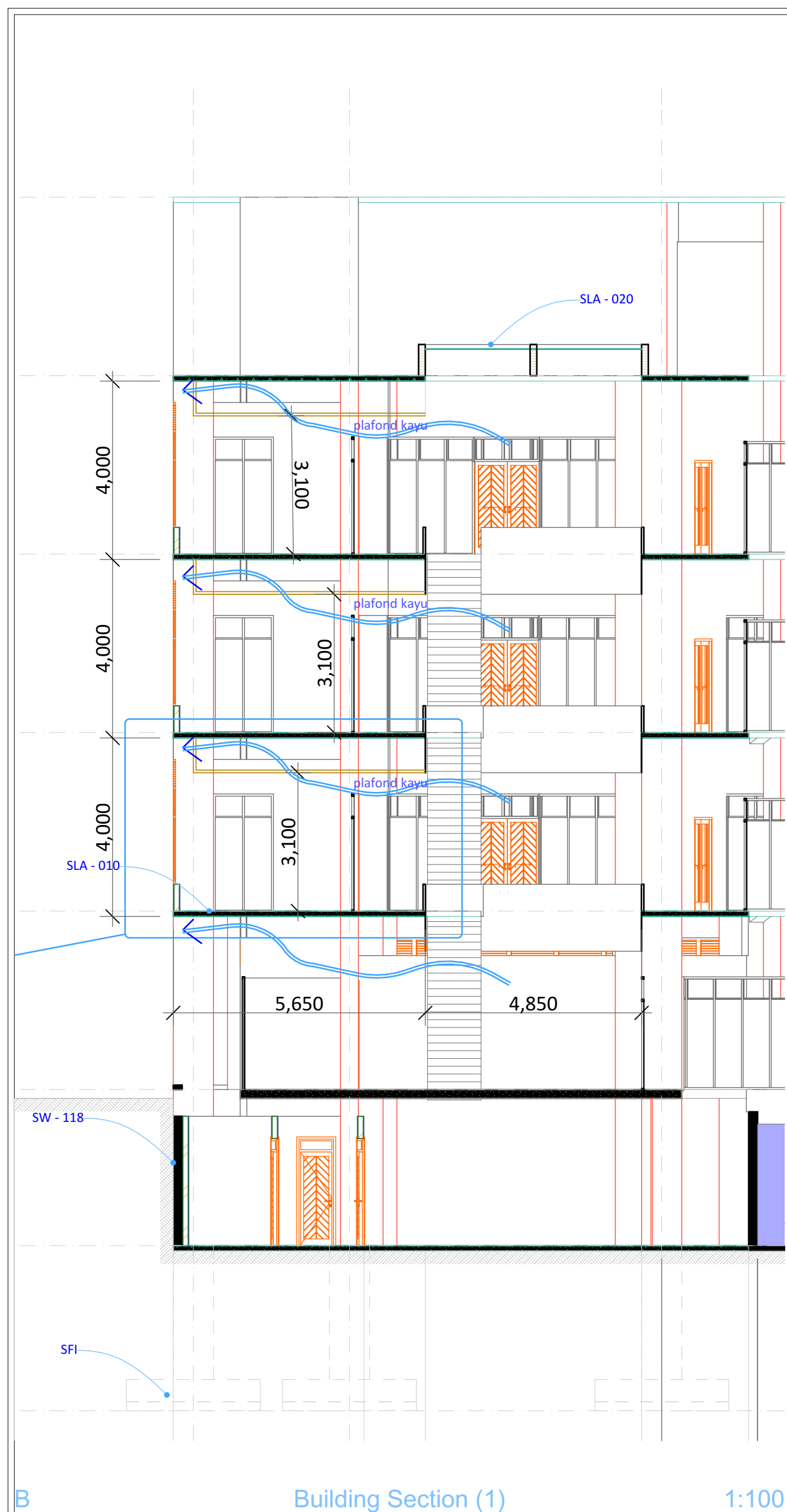

PROYEK AKHIR SARJANA

BANDUNG CULTURE AND TOURISM CENTER

DIBUAT OLEH :

NAMA : FREDY MAHENDRA  
NIM : 14 512 139

PEMBIMBING : M. Galieh Gunagama, S.T., M.Sc.

PENGUJI : Dr. Ir. Sugini, M.T., IAI

NAMA GAMBAR : Detail  
Hlm : A.01.13

JUDUL GAMBAR : B Detail Interior  
SKALA : 1:100, 1:200

DISETUJUI : NO. TANGGAL : CATATAN / REVISI :





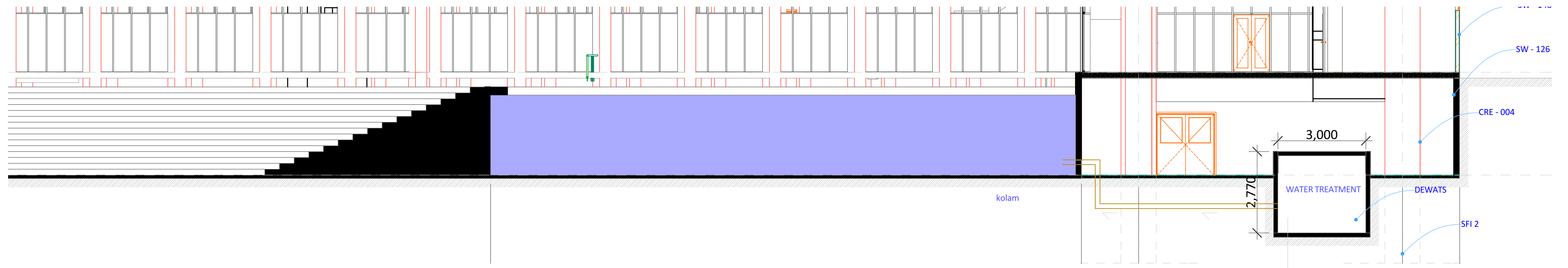

F

Building Section

mengubah air limbah menjadi air dengan kualitas mutu untuk penyiraman tanaman sayur.

1:100

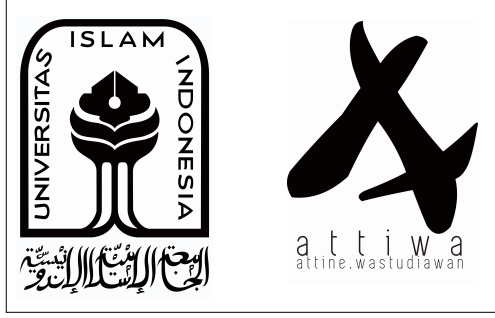
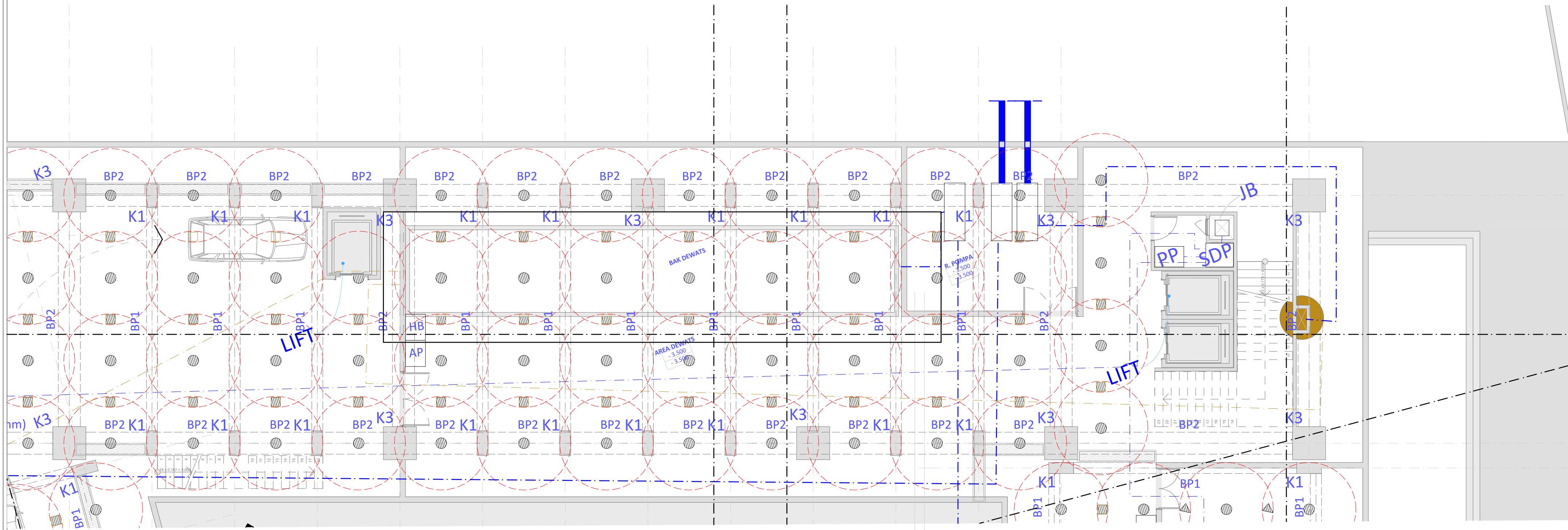

PROYEK AKHIR SARJANA  
**BANDUNG CULTURE AND TOURISM CENTER**

DIBUAT OLEH :  
 NAMA : FREDY MAHENDRA  
 NIM : 14 512 139  
 PEMBIMBING : M. Galieh Gunagama, S.T., M.Sc.  
 PENGUJI : Dr. Ir. Sugini, M.T., IAI

NAMA GAMBAR : Detail  
 A.01.13  
 JUDUL GAMBAR : F Detail DEWATS

Hlm :  
 SKALA : 1:100

NO.	TANGGAL	CATATAN / REVISI

NO.	TANGGAL	CATATAN / REVISI



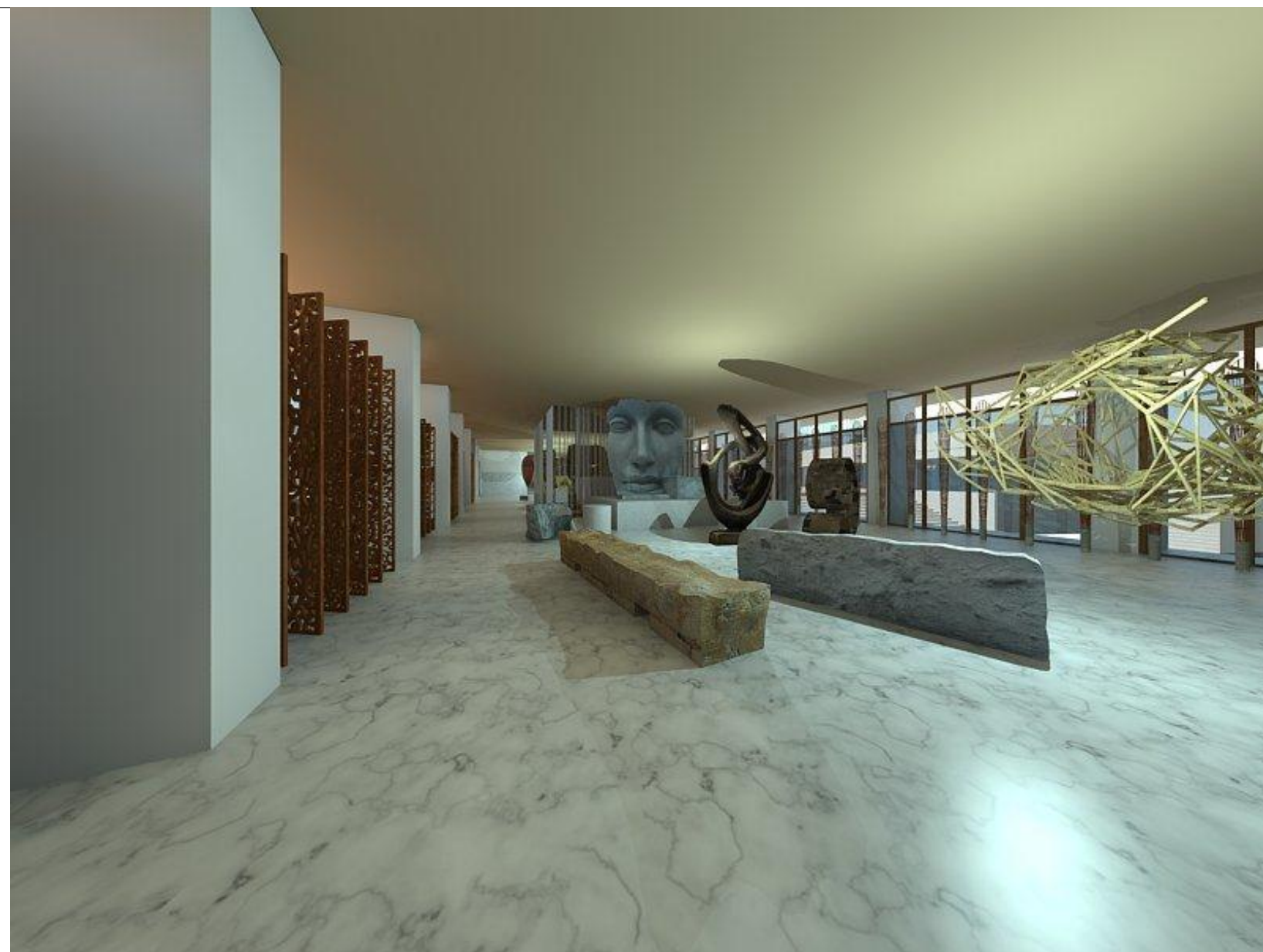

**INTERIOR MINI MUSEUM**



**INTERIOR MINI MUSEUM**



**INTERIOR AREA DISPLAY**



**INTERIOR TOURISM INFORMATION CENTER**

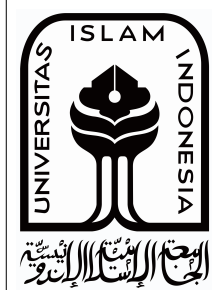

PROYEK AKHIR SARJANA  
**BANDUNG CULTURE AND TOURISM CENTER**

DIBUAT OLEH :  
 NAMA : FREDY MAHENDRA  
 NIM : 14 512 139  
 PEMBIMBING : M. Galieh Gunagama, S.T., M.Sc.  
 PENGUJI : Dr. Ir. Sugini, M.T., IAI

NAMA GAMBAR :  
 Hlm :  
 JUDUL GAMBAR :  
 SKALA :

DISETUJUI :  
 NO.  
 TANGGAL :

CATATAN / REVISI :





**INTERIOR MONEY CHANGER**



**INTERIOR FOODCOURT**



**INTERIOR CAFE**



**INTERIOR BASECAMP KOMUNITAS**

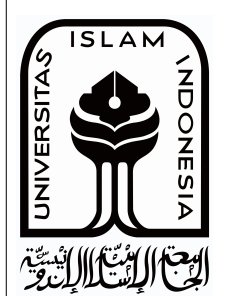

PROYEK AKHIR SARJANA  
**BANDUNG CULTURE AND TOURISM CENTER**

DIBUAT OLEH :  
 NAMA : FREDY MAHENDRA  
 NIM : 14 512 139  
 PEMBIMBING : M. Galieh Gunagama, S.T., M.Sc.  
 PENGUJI : Dr. Ir. Sugini, M.T., IAI

NAMA GAMBAR :  
 Hlm :  
 JUDUL GAMBAR :  
 SKALA :

DISETUJUI :  
 NO. :  
 TANGGAL :  
 CATATAN / REVISI :

CATATAN / REVISI :





**INTERIOR RUANG DISKUSI**



**INTERIOR RUANG KREATIF PUBLIK**



**INTERIOR LOBBY TEATER**



**INTERIOR TEATER**

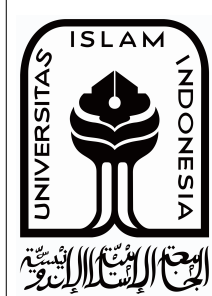

PROYEK AKHIR SARJANA

BANDUNG CULTURE AND TOURISM CENTER

DIBUAT OLEH :

NAMA :

NIM :

FREDY MAHENDRA

14 512 139

PEMBIMBING :

M. Galieh Gunagama, S.T., M.Sc.

PENGUJI :

Dr. Ir. Sugini, M.T., IAI

NAMA GAMBAR :

Hlm :

DISETUJUI :

NO.

TANGGAL :

CATATAN / REVISI :

JUDUL GAMBAR :

SKALA :





**AREA LAHAN TANAM**



**AREA LAHAN TANAM**

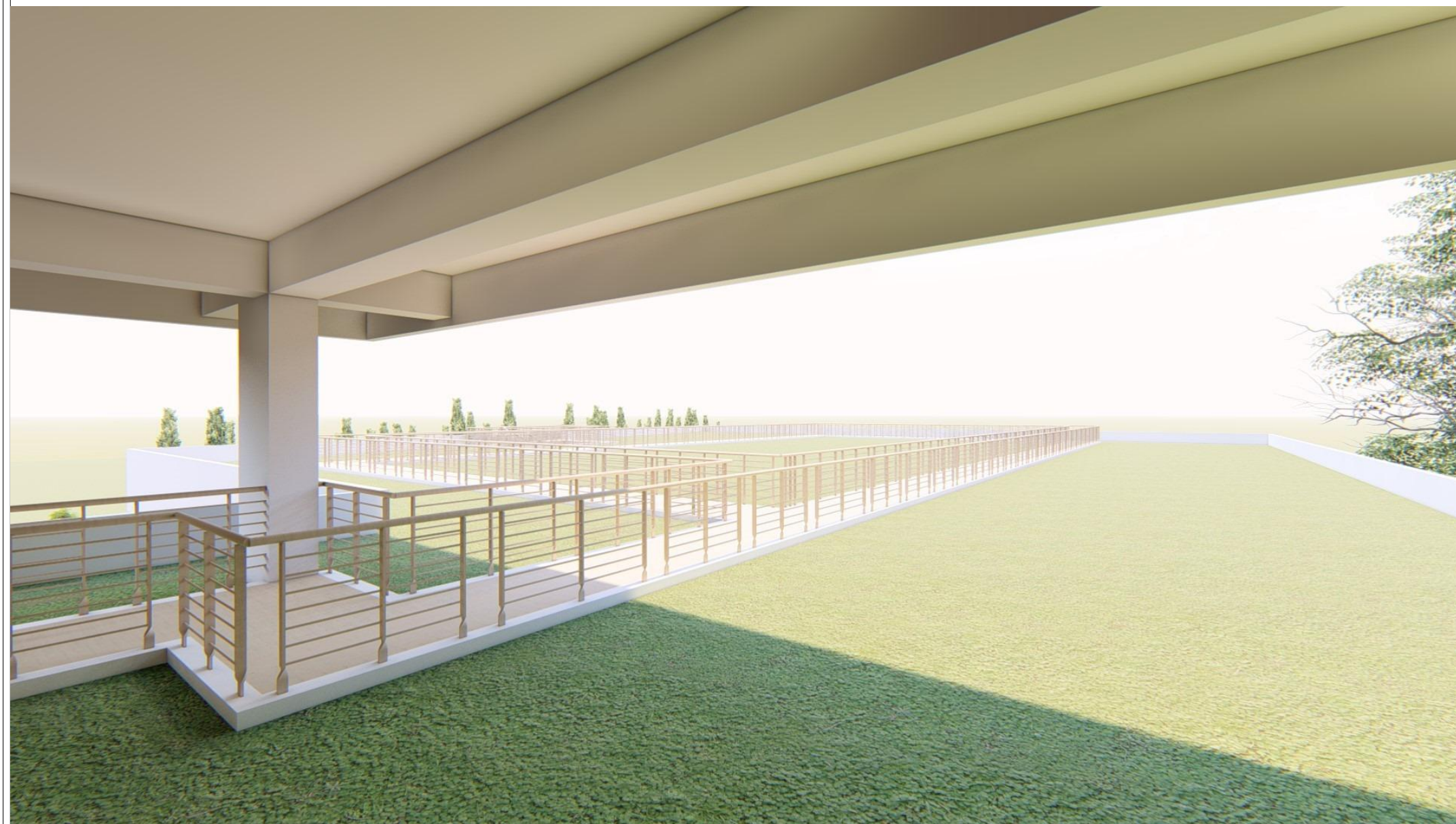

**AREA LAHAN TANAM**



**AREA LAHAN TANAM**



PROYEK AKHIR SARJANA  BANDUNG CULTURE AND TOURISM CENTER	DIBUAT OLEH : NAMA : FREDY MAHENDRA NIM : 14 512 139		NAMA GAMBAR : Hlm : DISETUJUI : NO. TANGGAL :	CATATAN / REVISI :		
	PEMBIMBING : M. Galieh Gunagama, S.T., M.Sc.	PENGUJI : Dr. Ir. Sugini, M.T., IAI	JUDUL GAMBAR : SKALA :			





**PERSPEKTIF EKSTERIOR**

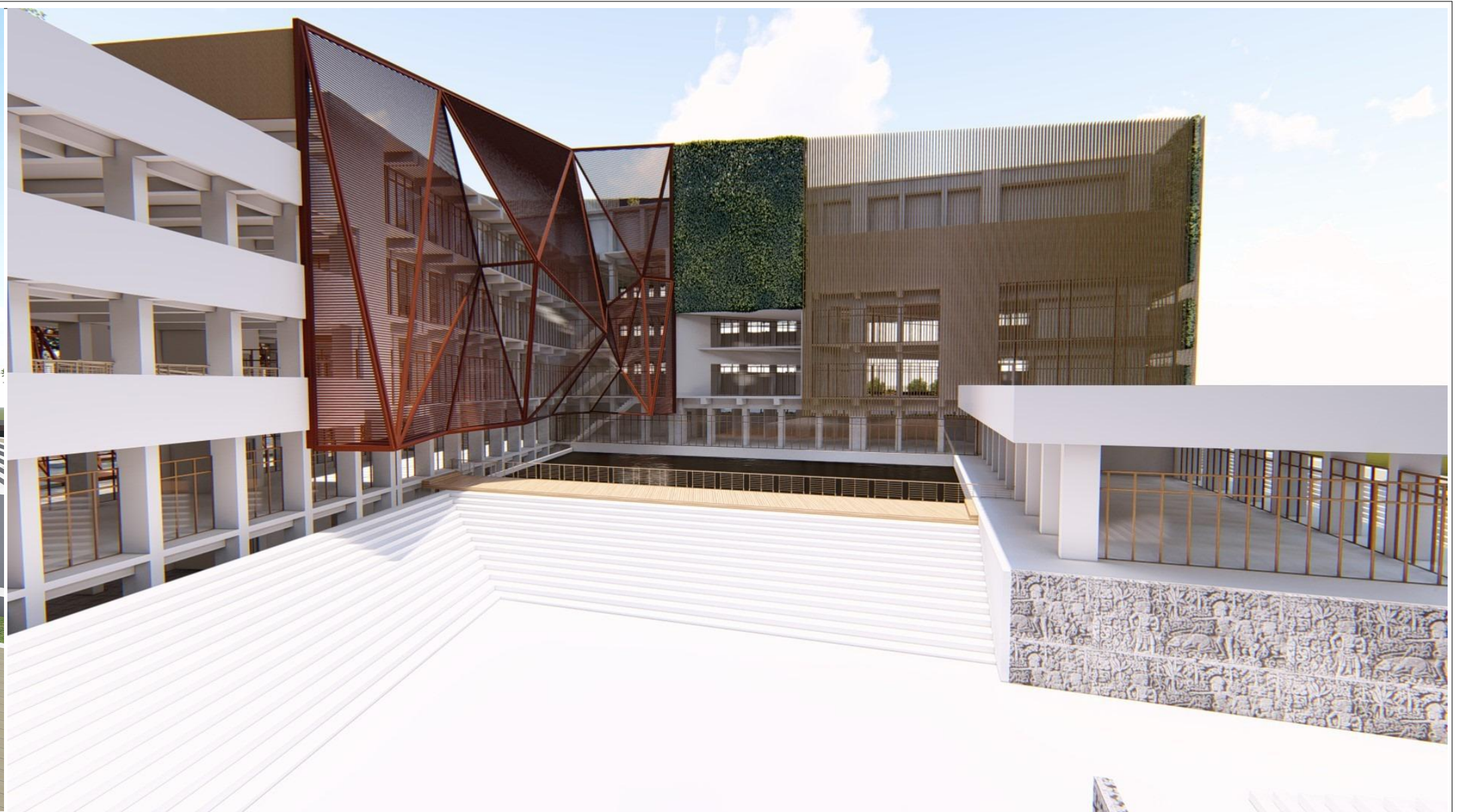

**PERSPEKTIF EKSTERIOR**

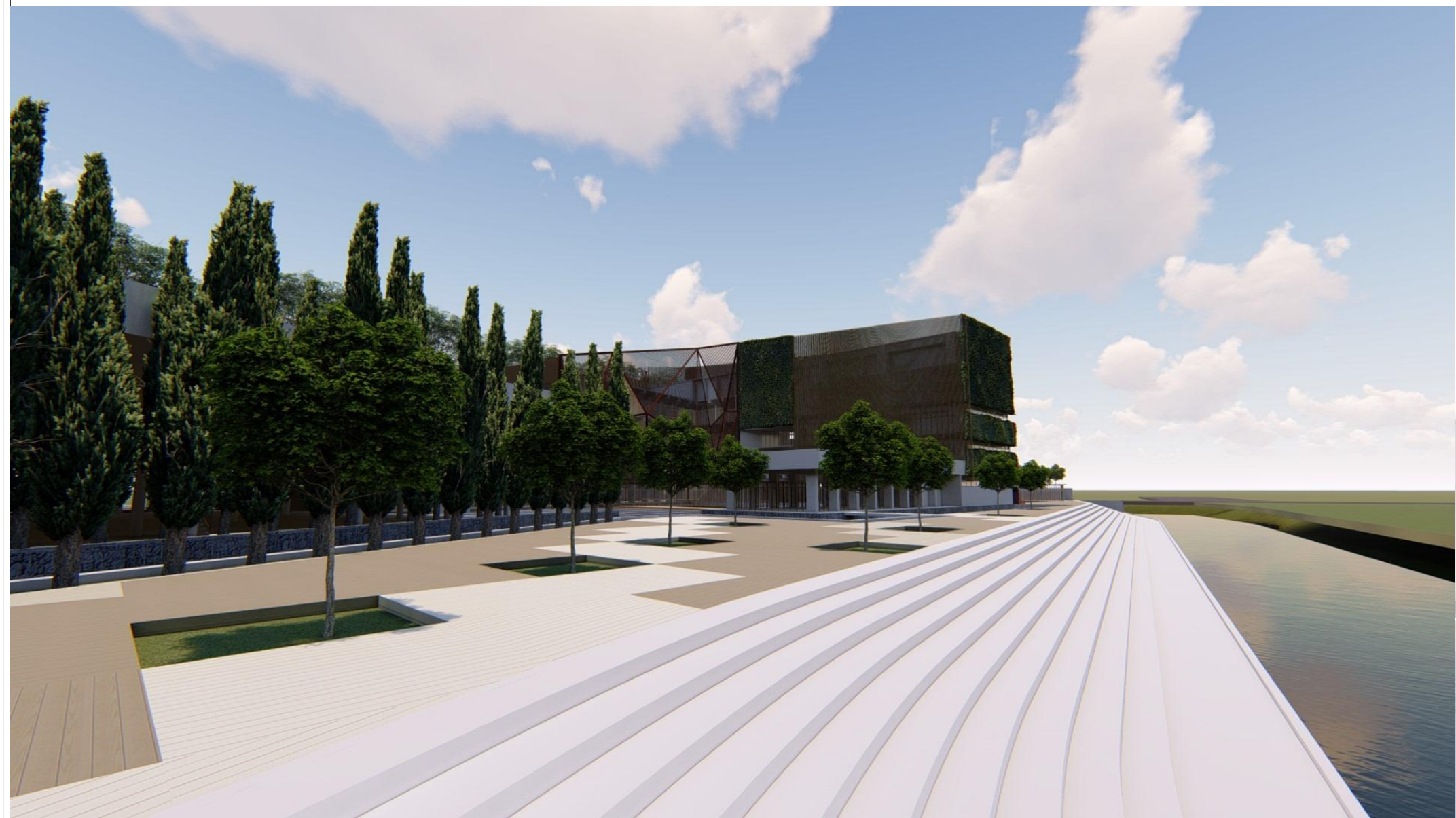

**PERSPEKTIF EKSTERIOR RIVERSPOT**



**PERSPEKTIF EKSTERIOR WATER BODIES**



PROYEK AKHIR SARJANA  
 BANDUNG CULTURE AND TOURISM CENTER

DIBUAT OLEH :  
 NAMA : FREDY MAHENDRA  
 NIM : 14 512 139  
 PEMBIMBING : M. Galieh Gunagama, S.T., M.Sc.  
 PENGUJI : Dr. Ir. Sugini, M.T., IAI

NAMA GAMBAR :  
 JUDUL GAMBAR :

Hlm :  
 SKALA :

DISETUJUI :  
 NO. :  
 TANGGAL :

CATATAN / REVISI :





**PERSPEKTIF EKSTERIOR DINDING SEJARAH**



**PERSPEKTIF EKSTERIOR LAHAN TANAM**



**AERIAL PERSPEKTIF**

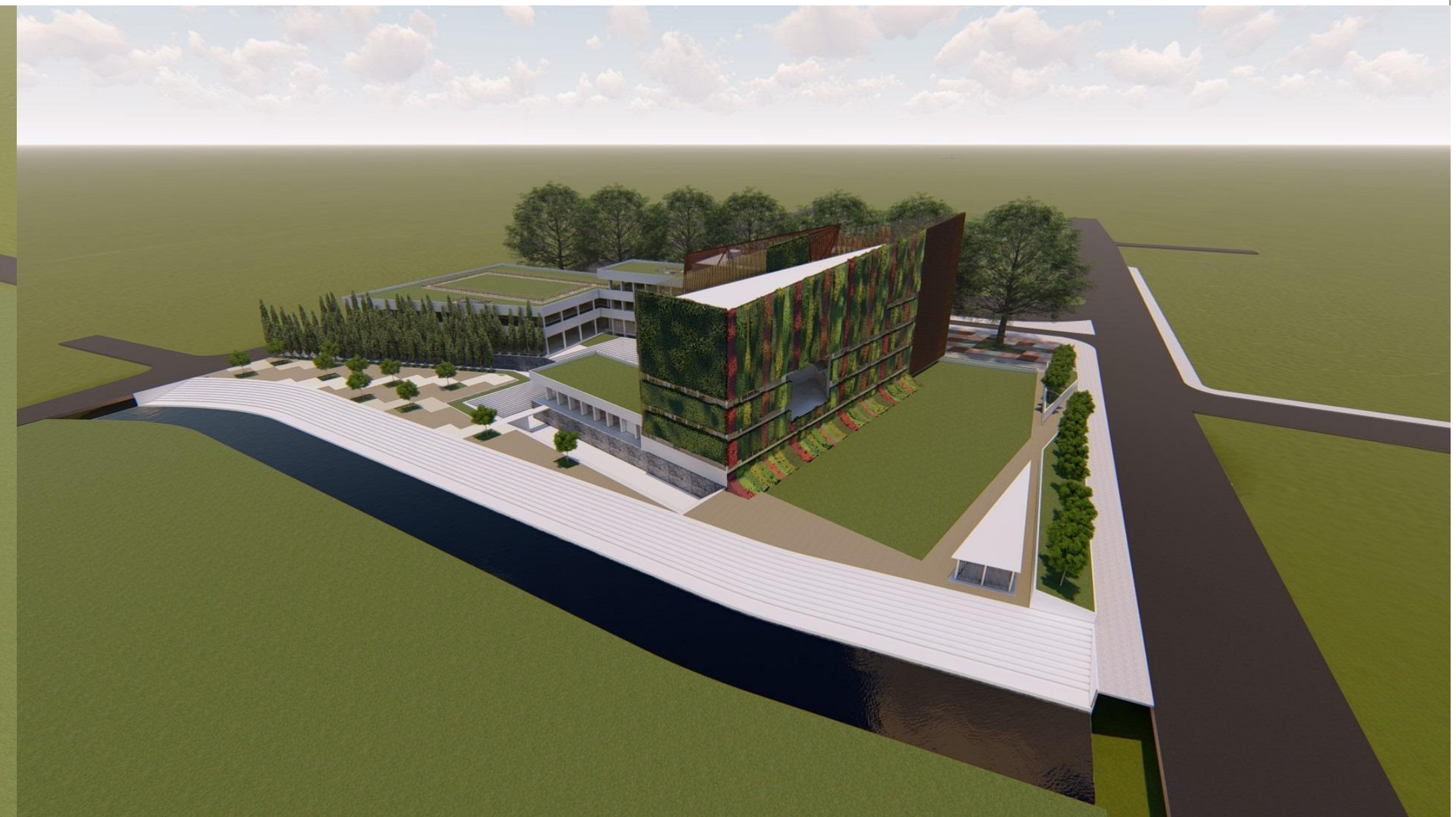

**AERIAL PERSPEKTIF**



PROYEK AKHIR SARJANA  BANDUNG CULTURE AND TOURISM CENTER	DIBUAT OLEH :		NAMA GAMBAR :	Hlm :	DISETUJUI :	NO.	TANGGAL :	CATATAN / REVISI :
	NAMA :	NIM :						
	FREDY MAHENDRA	14 512 139	JUDUL GAMBAR :	SKALA :				
	PEMBIMBING :	M. Galieh Gunagama, S.T., M.Sc.						
	PENGUJI :	Dr. Ir. Sugini, M.T., IAI						







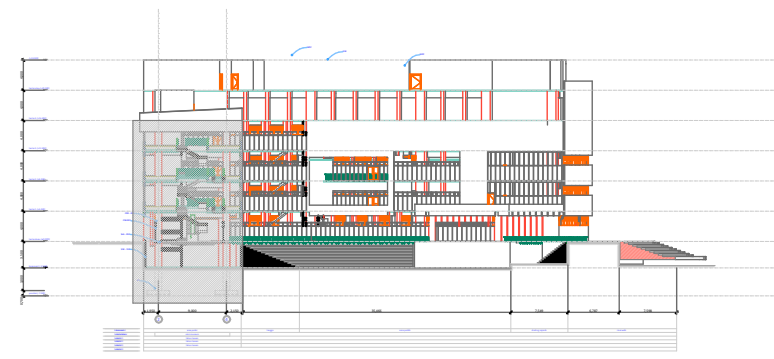

**KEYPLAN POTONGAN A-A**  
1 : 1000

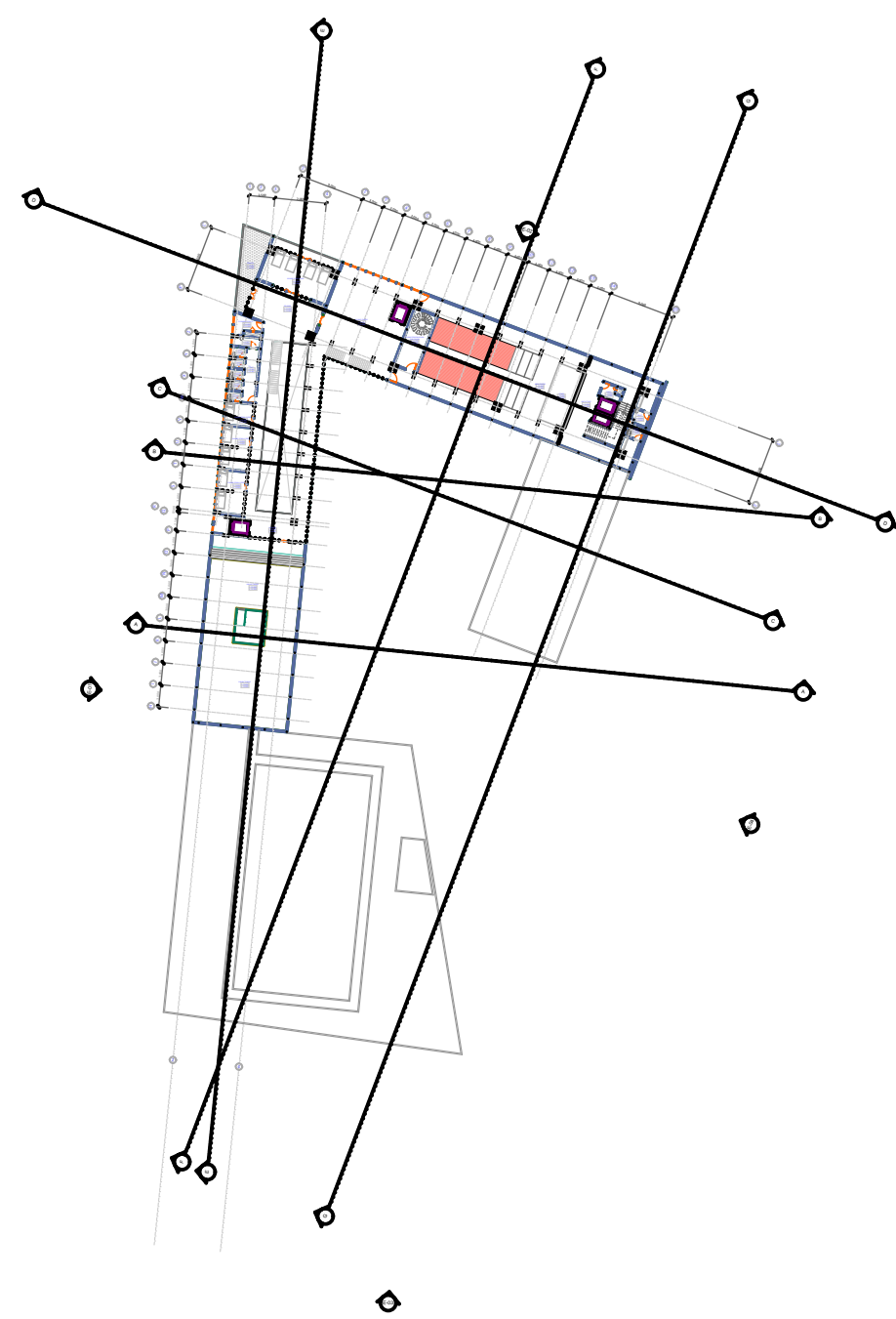

**KEYPLAN DENAH LANTAI 3**  
1 : 1000



**DETAIL POTONGAN A-A**  
1 : 100

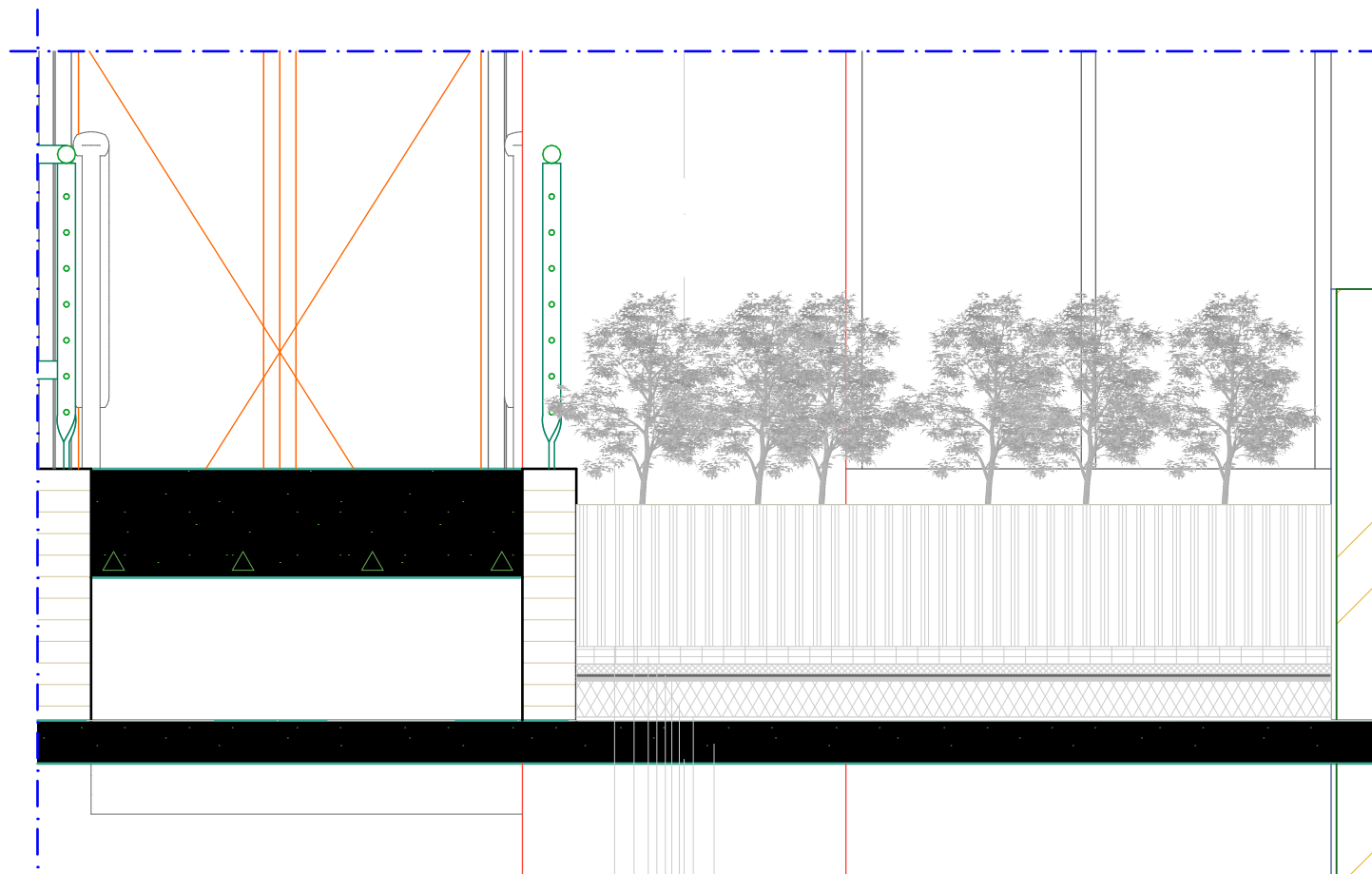

- tanaman
- tanah urug, tebal : 400 mm
- progreen R50, tebal : 60 mm
- progreen D11, tebal : 30 mm
- protan F4M fleece, tebal : 5 mm
- protan GG membrane, tebal : 5 mm
- protan approved insulation, tebal : 100 mm
- protan VB250 VCL, tebal : 5 mm
- plat beton, tebal : 120 mm

**DETAIL KONSTRUKSI  
ROOF FARMING**

1 : 20

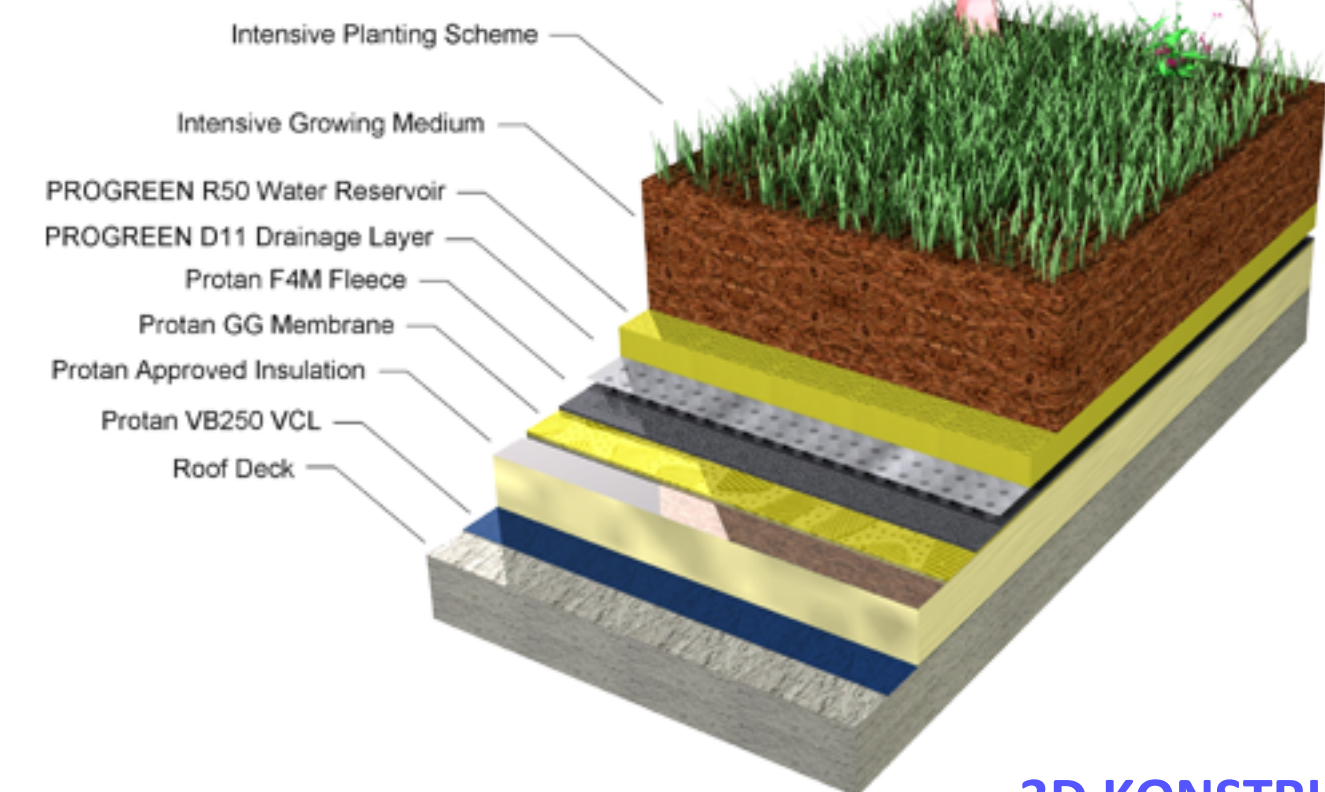

**3D KONSTRUKSI  
ROOF FARMING**

NTS



PROYEK AKHIR SARJANA  
**BANDUNG CULTURE AND TOURISM CENTER**

DIBUAT OLEH :

NAMA :	NIM :
FREDY MAHENDRA	14 512 139
PEMBIMBING :	M. Galieh Gunagama, S.T., M.Sc.
PENGUJI :	Dr. Ir. Sugini, M.T., IAI

NAMA GAMBAR :  
Detail  
A.01.13

JUDUL GAMBAR :  
3. Detail Konstruksi Roof Farming

Hlm :  
SKALA :  
1:1000, 1:100,  
1:20

DISETUJUI : NO. TANGGAL :

CATATAN / REVISI :