

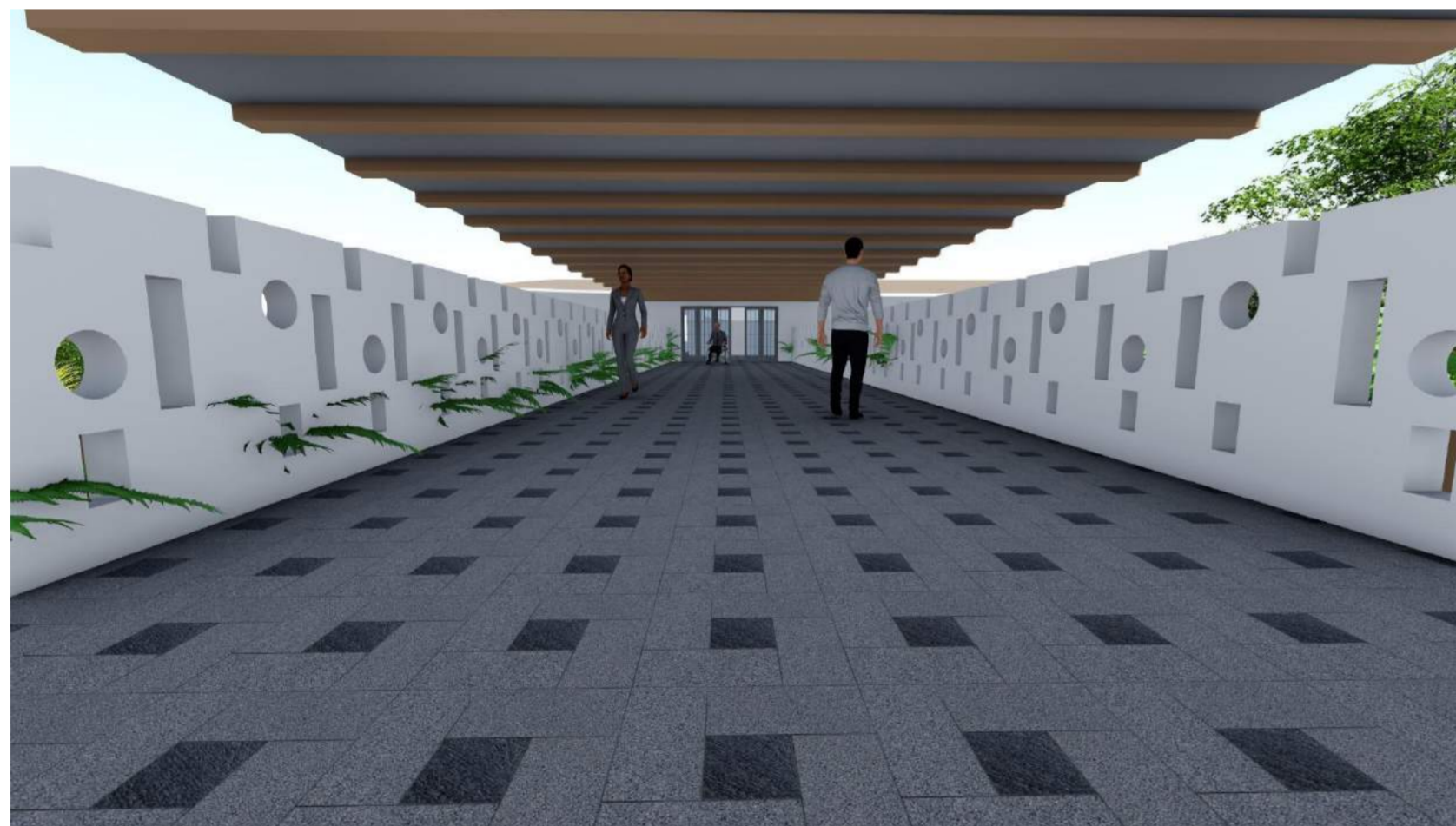

PROJECT	LOCATION	DRAWING NAME	DRAWING BY	DESCRIPTION	NOTES	PAGE	 JURUSAN ARSITEKTUR FAKULTAS TEKNIK SIPIL DAN PERENCANAAN UNIVERSITAS ISLAM INDONESIA
Barchelor Final Project "WASTE LIVING LABORATORY PIYUNGAN"	TPST Piyungan Ngablak, Sitimulyo, Piyungan, Bantul, DIY	EKSTERIOR	Fairuz Rana Zhavira 14512017				
		SCALE				TOTAL PAGE	



PROJECT	LOCATION	DRAWING NAME	DRAWING BY	DESCRIPTION	NOTES	PAGE
Bachelor Final Project "WASTE LIVING LABORATORY PIYUNGAN"	TPST Piyungan Ngablak, Sitimulyo, Piyungan, Bantul, DIY	INTERIOR	Fairuz Rana Zhavira 14512017			
		SCALE				TOTAL PAGE



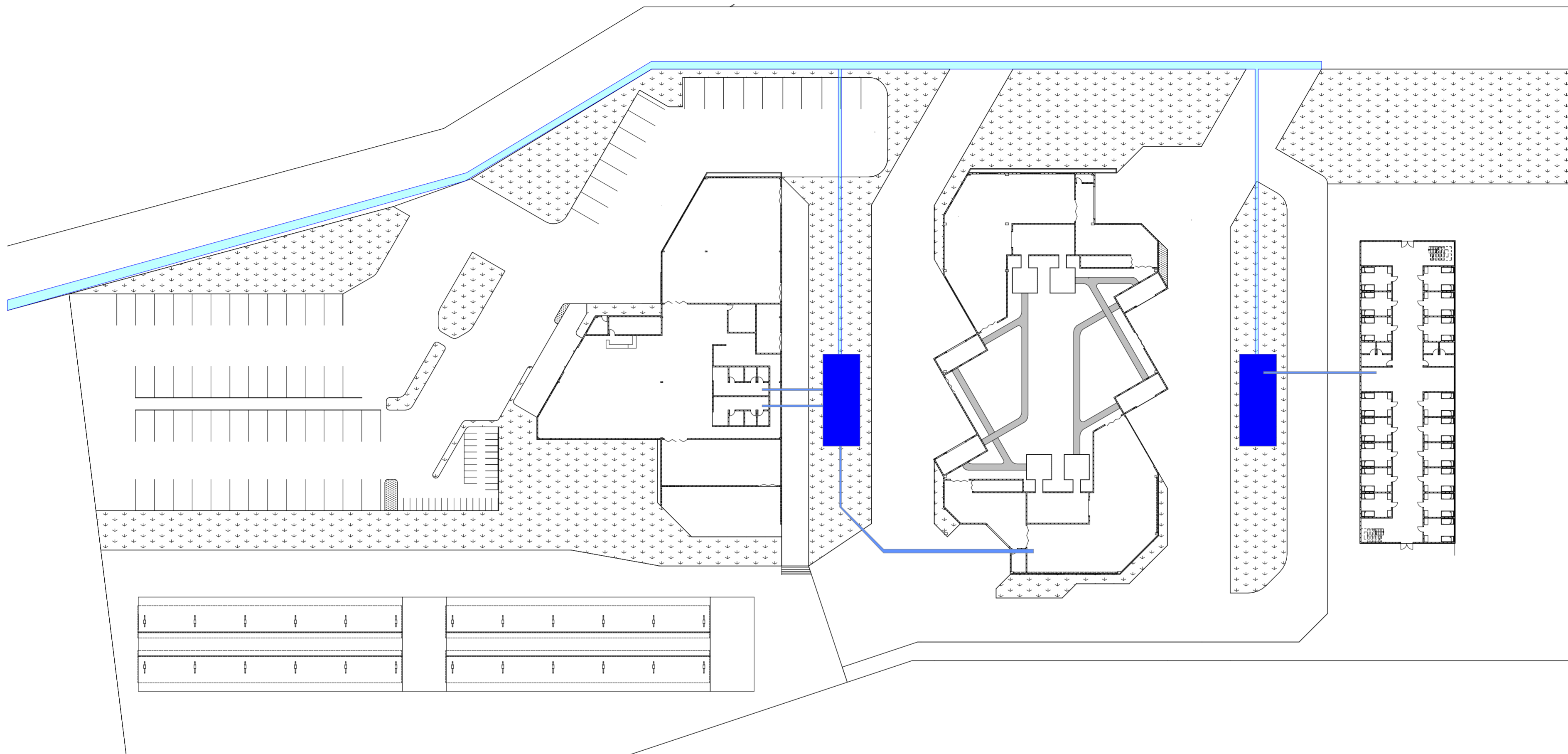

PROJECT	LOCATION	DRAWING NAME	DRAWING BY	DESCRIPTION	NOTES	PAGE	
Bachelor Final Project "WASTE LIVING LABORATORY PIYUNGAN"	TPST Piyungan Ngablak, Sitimulyo, Piyungan, Bantul, DIY	Skema penyediaan air bersih	Fairuz Rana Zhavira 14512017	 <ul style="list-style-type: none"> Sumber air pdam Ground water tank Distribusi 			 JURUSAN ARSITEKTUR FAKULTAS TEKNIK SIPIL DAN PERENCANAAN UNIVERSITAS ISLAM INDONESIA
		SCALE				TOTAL PAGE	

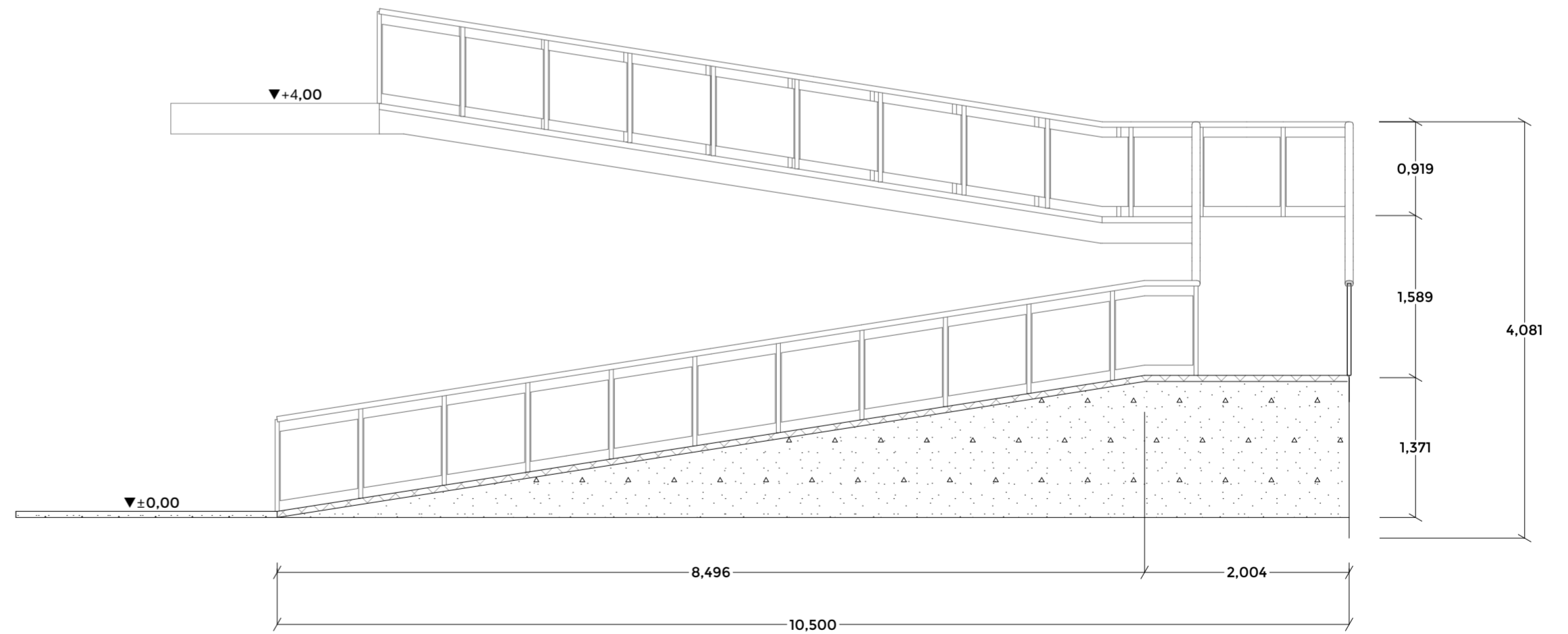
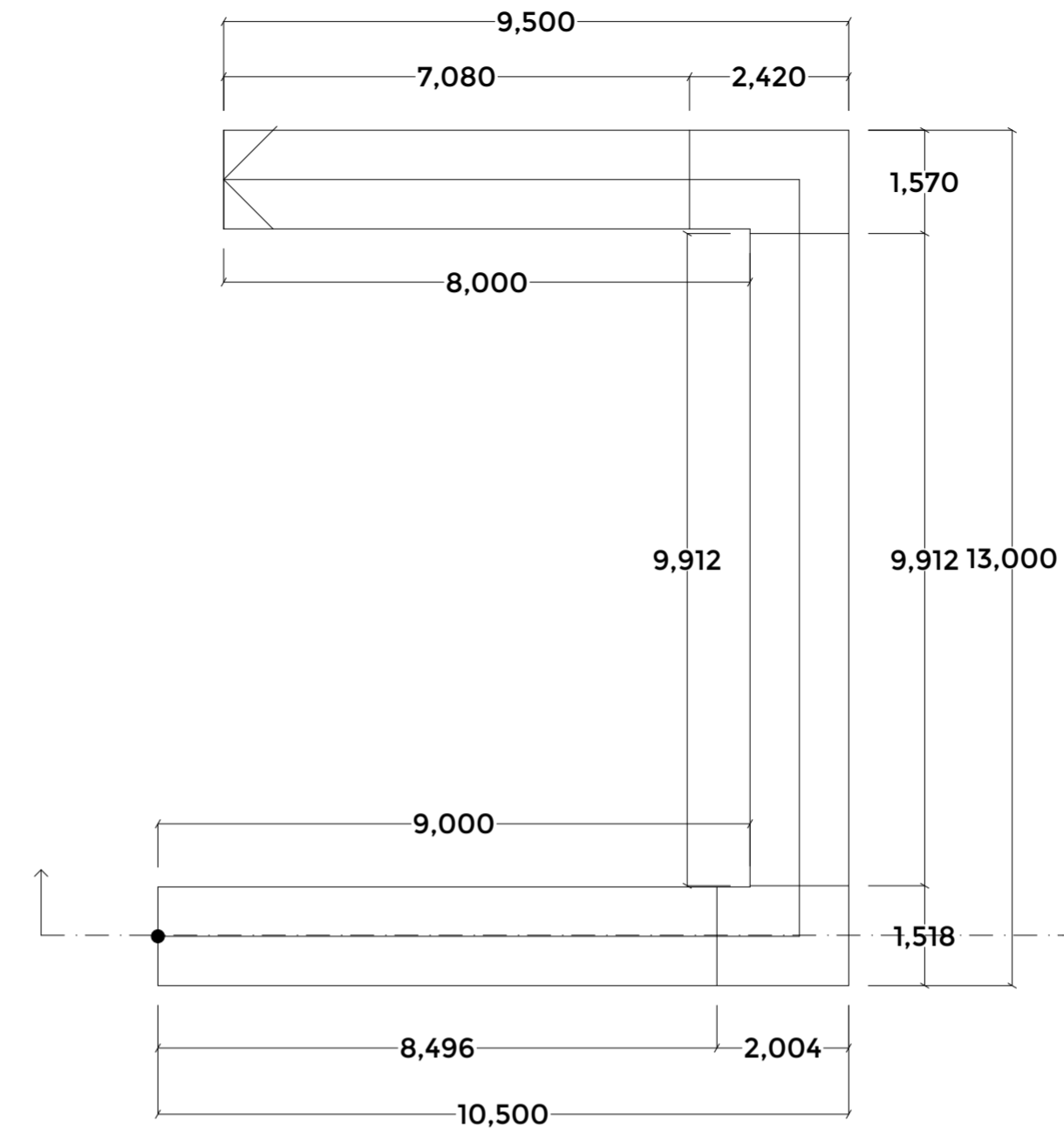
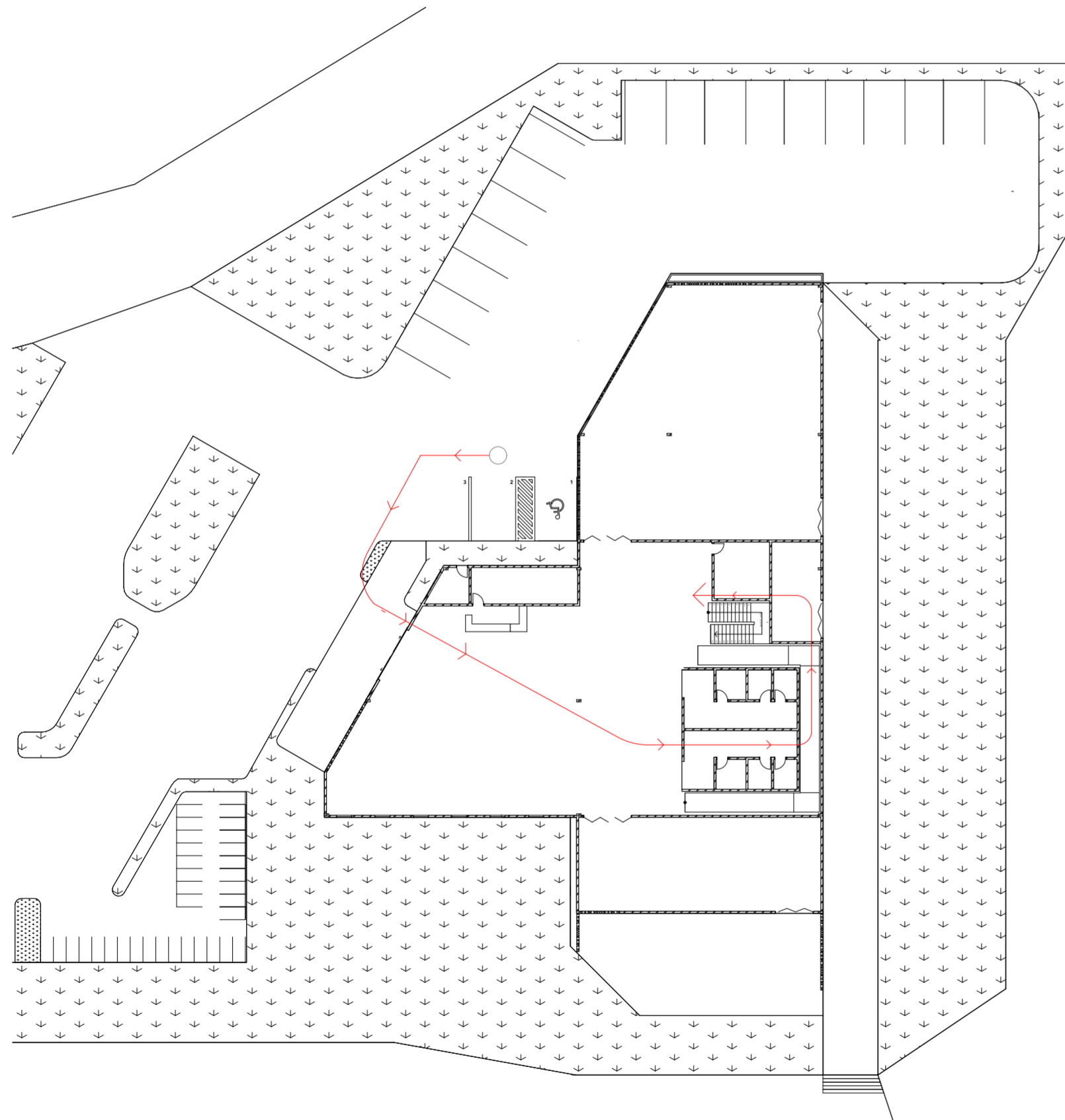
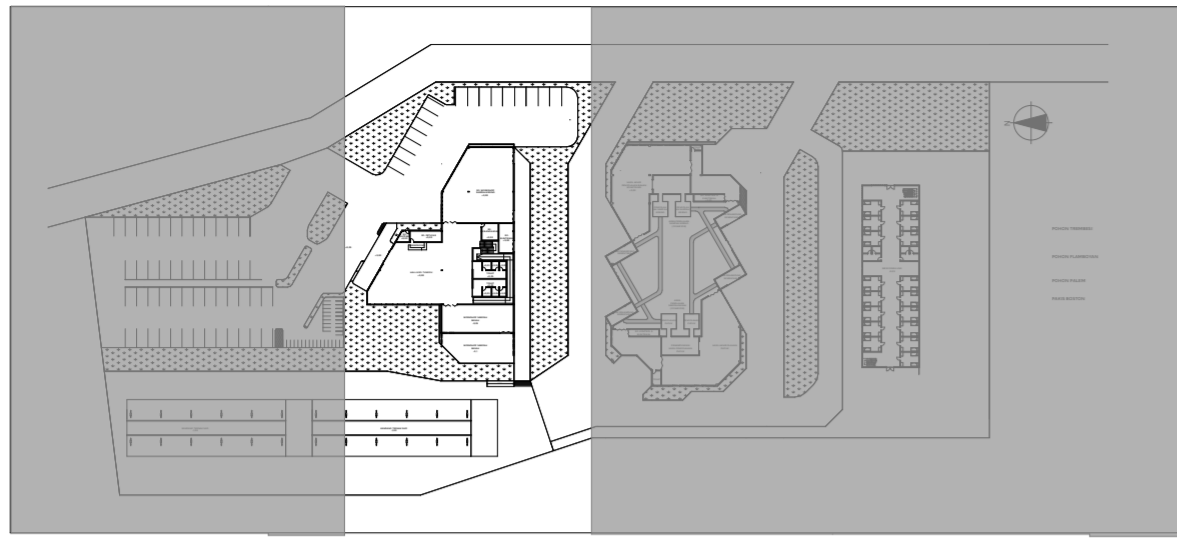

PROJECT	LOCATION	DRAWING NAME	DRAWING BY	DESCRIPTION	NOTES	PAGE
Bachelor Final Project "WASTE LIVING LABORATORY PIYUNGAN"	TPST Piyungan Ngablak, Sitimulyo, Piyungan, Bantul, DIY	Skema barrier free, Siteplan, Potongan Ramp	Fairuz Rana Zhavira 14512017	  Titik parkir difabel  Jalur menuju ramp		
		SCALE				TOTAL PAGE



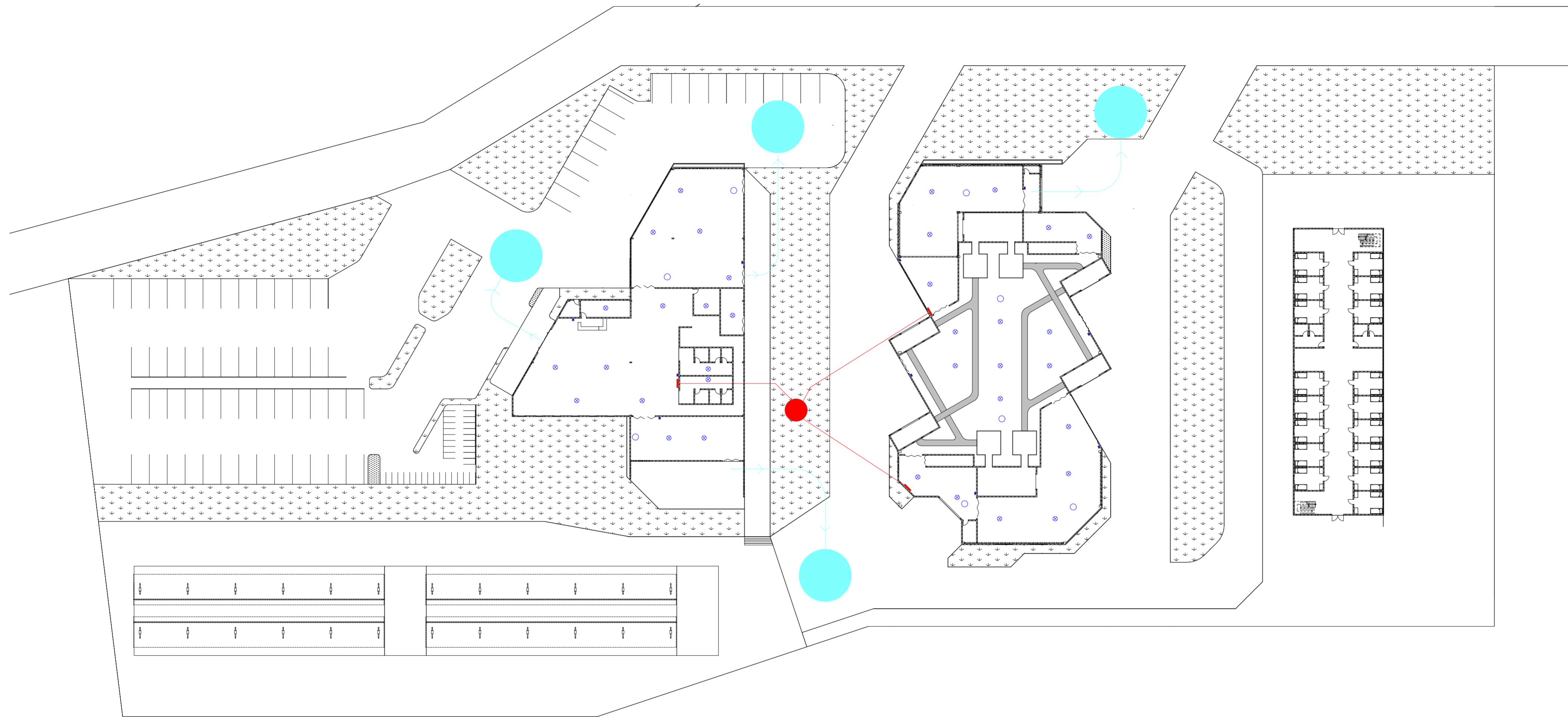

PROJECT	LOCATION	DRAWING NAME	DRAWING BY	DESCRIPTION	NOTES	PAGE	
Bachelor Final Project "WASTE LIVING LABORATORY PIYUNGAN"	TPST Piyungan Ngablak, Sitimulyo, Piyungan, Bantul, DIY	Skema penanggulangan kebakaran dan evakuasi	Fairuz Rana Zhavira	 <ul style="list-style-type: none"> ● Fire hydrant — Fire hose Smoke detector × Sprinkle ■ Fire estinguisher ● Meeting point → Jalur menuju meeting point 			 JURUSAN ARSITEKTUR FAKULTAS TEKNIK SIPIL DAN PERENCANAAN UNIVERSITAS ISLAM INDONESIA
		SCALE	14512017			TOTAL PAGE	

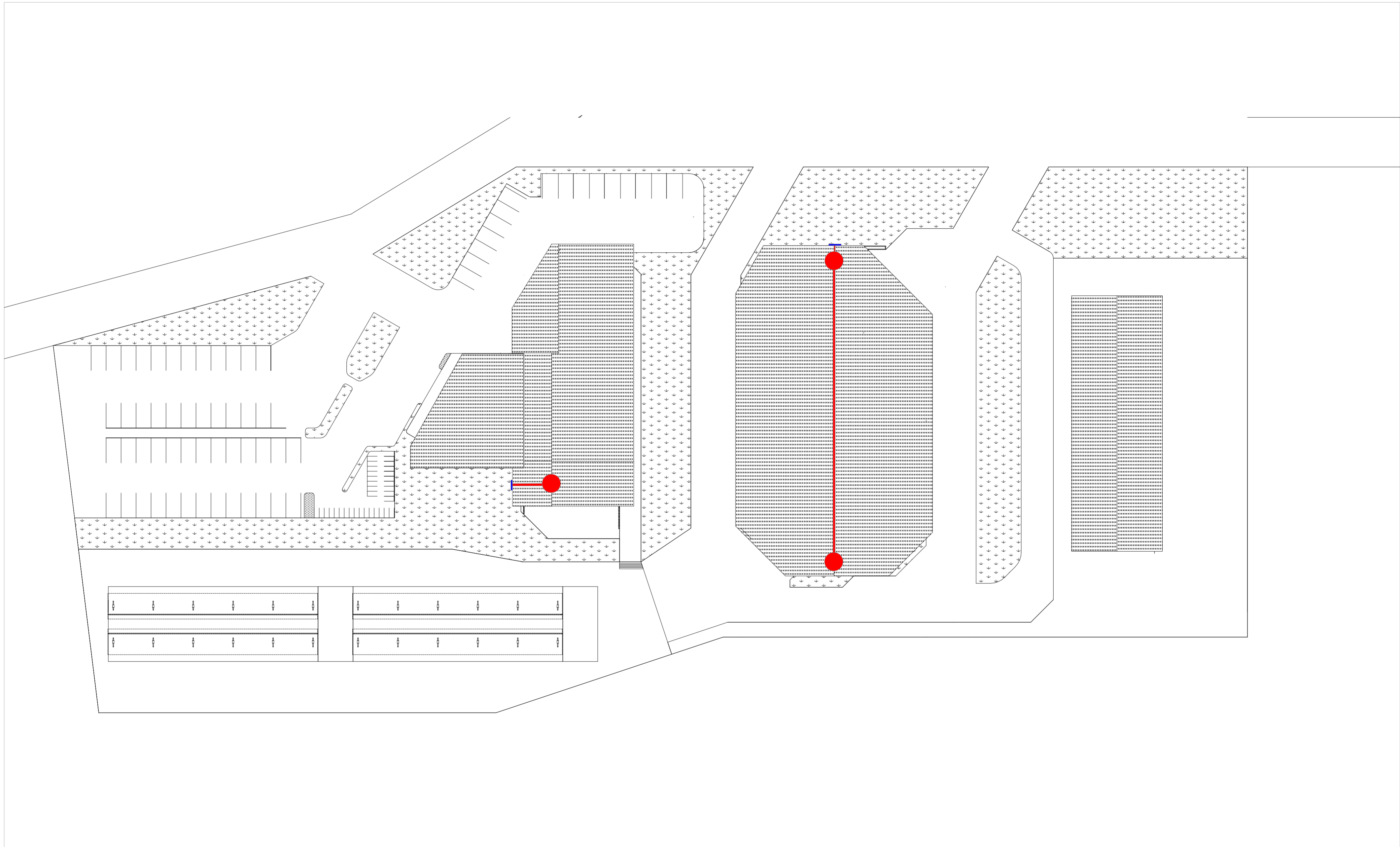

PROJECT	LOCATION	DRAWING NAME	DRAWING BY	DESCRIPTION	NOTES	PAGE	 JURUSAN ARSITEKTUR FAKULTAS TEKNIK SIPIL DAN PERENCANAAN UNIVERSITAS ISLAM INDONESIA
Barchelor Final Project "WASTE LIVING LABORATORY PIYUNGAN"	TPST Piyungan Ngablak, Sitimulyo, Piyungan, Bantul, DIY	Skema penangkal petir	Fairuz Rana Zhavira 14512017	 Titik penangkal petir  Grounding			
		SCALE				TOTAL PAGE	

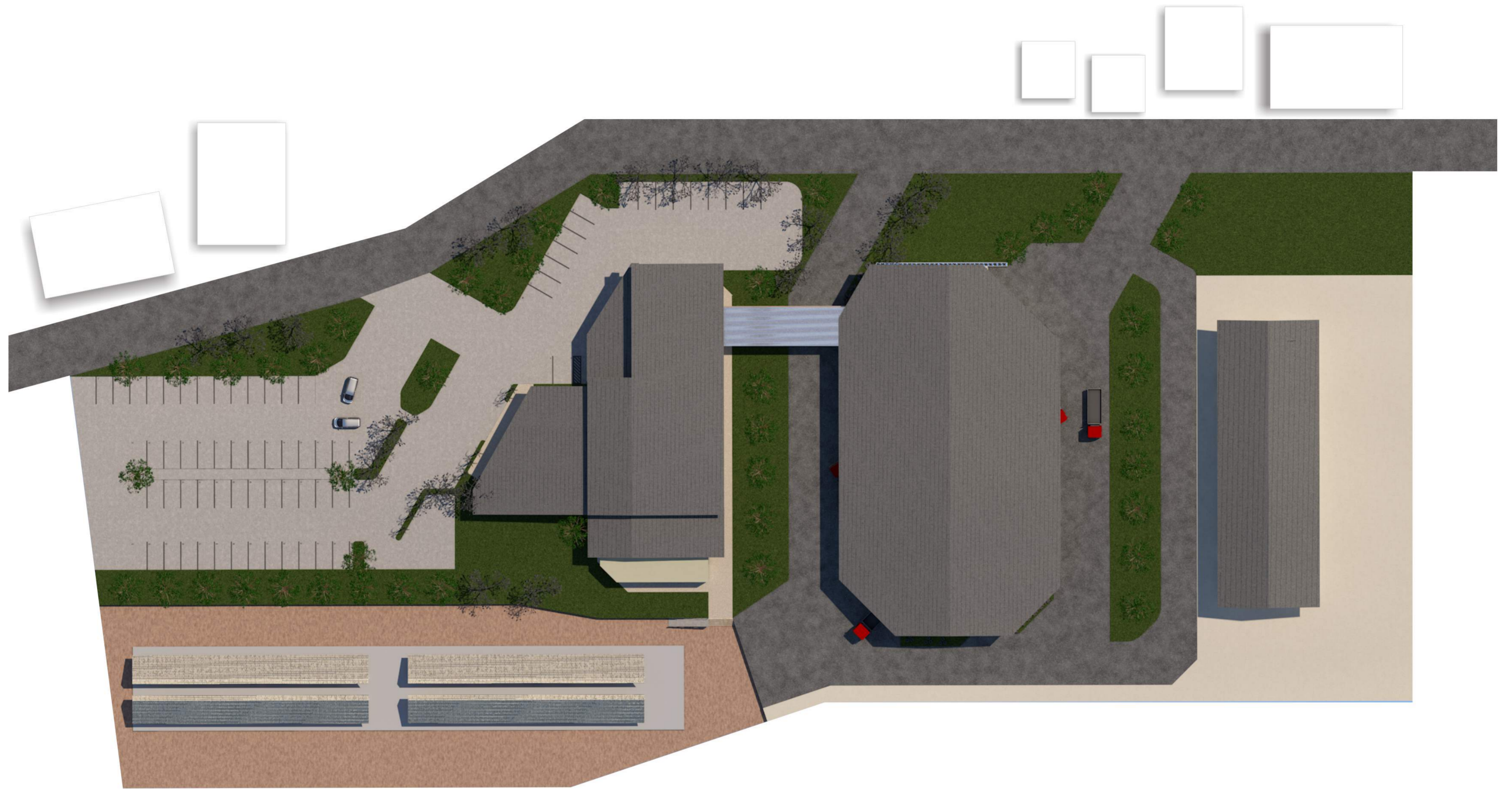

PROJECT	LOCATION	DRAWING NAME	DRAWING BY	DESCRIPTION	NOTES	PAGE
Barchelor Final Project "WASTE LIVING LABORATORY PIYUNGAN"	TPST Piyungan Ngablak, Sitimulyo, Piyungan, Bantul, DIY	SITUASI	Fairuz Rana Zhavira 14512017			
		SCALE				TOTAL PAGE



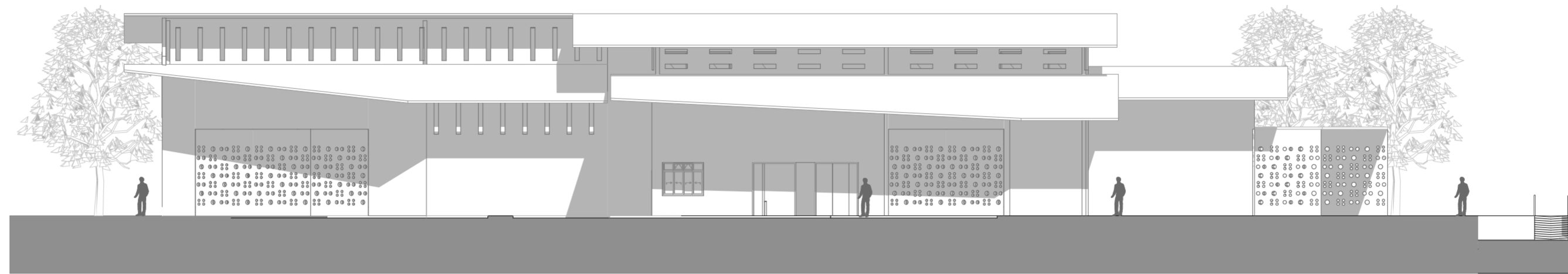

Tampak utara pukul 13.00
1:200



Tampak selatan pukul 11.00
1:200

PROJECT	LOCATION	DRAWING NAME	DRAWING BY	DESCRIPTION	NOTES	PAGE	 JURUSAN ARSITEKTUR FAKULTAS TEKNIK SIPIL DAN PERENCANAAN UNIVERSITAS ISLAM INDONESIA
Bachelor Final Project "WASTE LIVING LABORATORY PIYUNGAN"	TPST Piyungan Ngablak, Sitimulyo, Piyungan, Bantul, DIY	Tampak utara pukul 13.00, Tampak selatan pukul 11.00	Fairuz Rana Zhavira 14512017			TOTAL PAGE	
		SCALE					
		1:200					

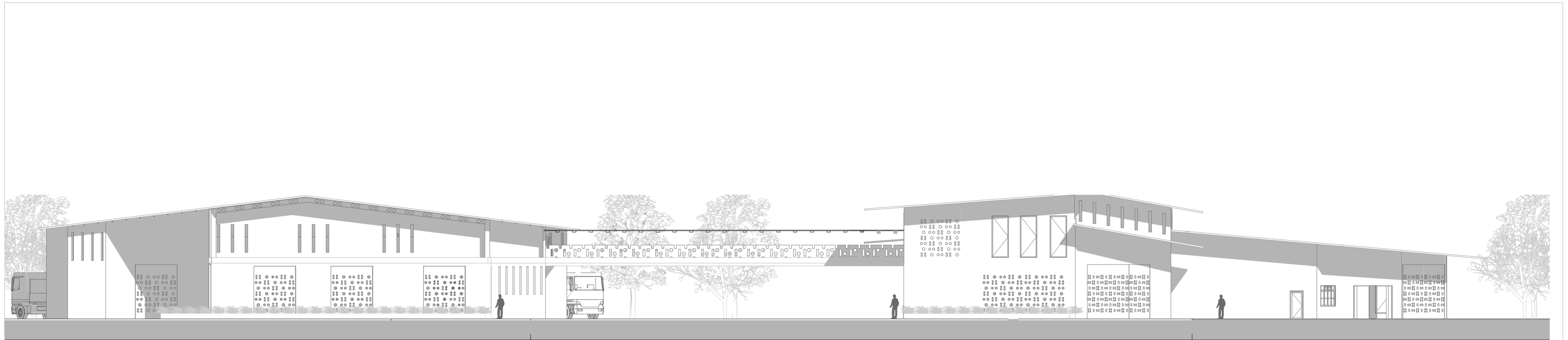

Tampak Timur Bangunan pukul 09.00
1:200

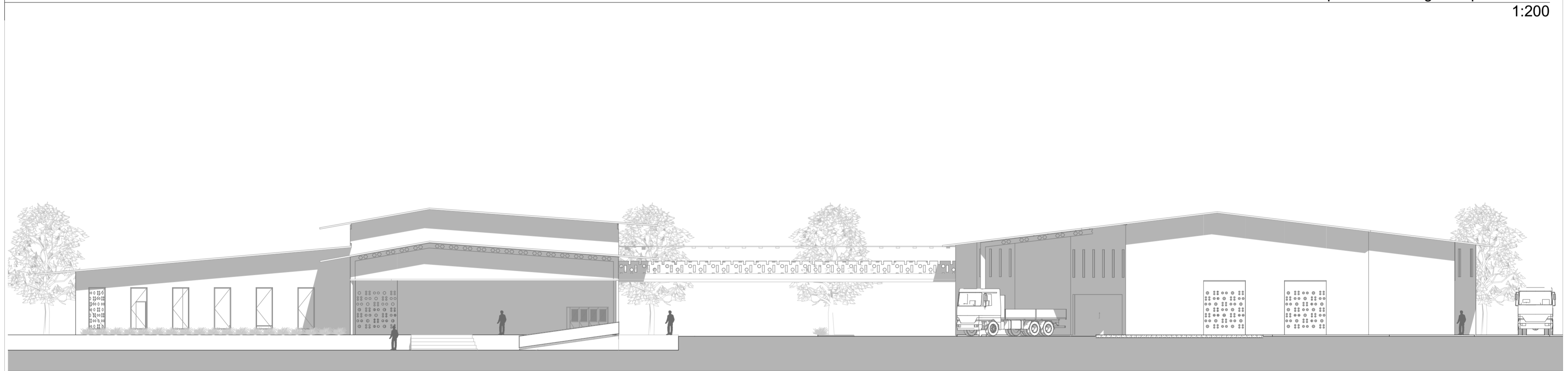

Tampak Barat Bangunan pukul 15.00
1:200

PROJECT	LOCATION	DRAWING NAME	DRAWING BY	DESCRIPTION	NOTES	PAGE	 JURUSAN ARSITEKTUR FAKULTAS TEKNIK SIPIL DAN PERENCANAAN UNIVERSITAS ISLAM INDONESIA
Bachelor Final Project "WASTE LIVING LABORATORY PIYUNGAN"	TPST Piyungan Ngablak, Sitimulyo, Piyungan, Bantul, DIY	Tampak Timur Bangunan pukul 09.00, Tampak Barat Bangunan pukul 15.00	Fairuz Rana Zhavira 14512017			TOTAL PAGE	
		SCALE					
		1:200					

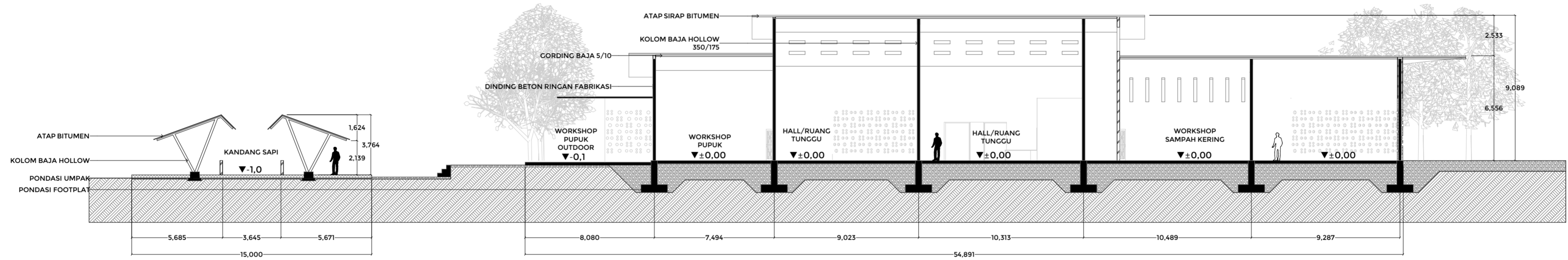
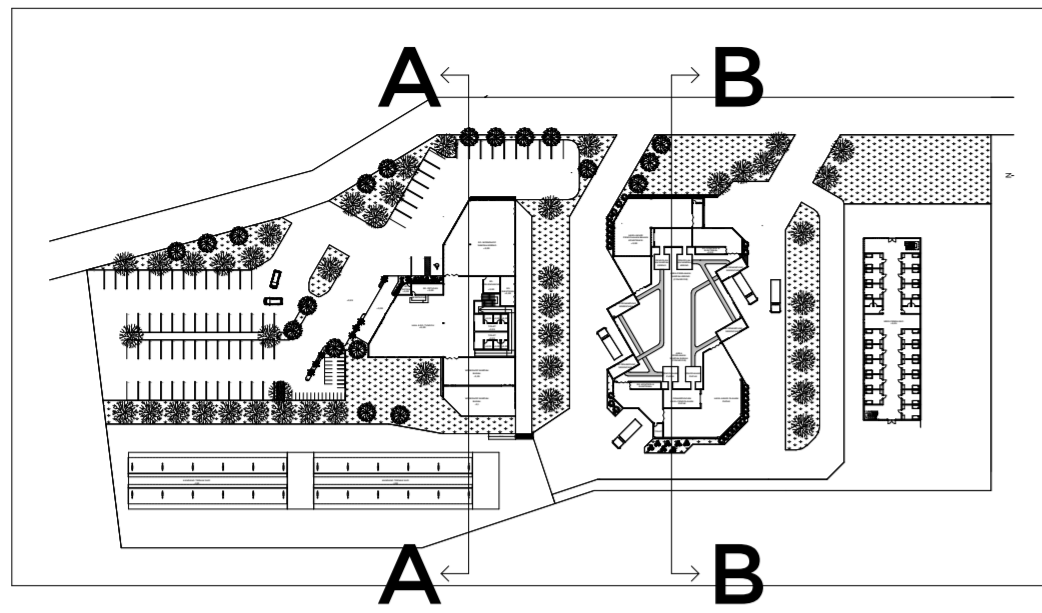

Potongan A

1:200

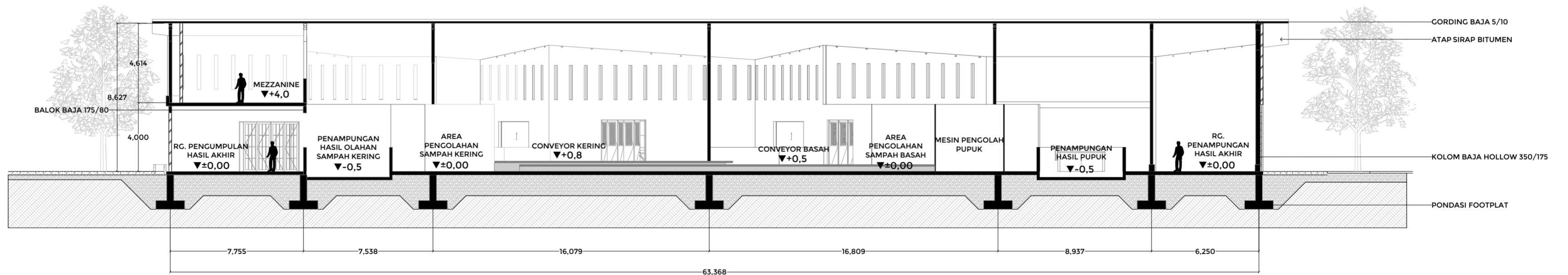

Potongan B

1:200

PROJECT	LOCATION	DRAWING NAME	DRAWING BY	DESCRIPTION	NOTES	PAGE
Bachelor Final Project "WASTE LIVING LABORATORY PIYUNGAN"	TPST Piyungan Ngablak, Sitimulyo, Piyungan, Bantul, DIY	Potongan A, Siteplan, Potongan B	Fairuz Rana Zhavira 14512017			
		SCALE				TOTAL PAGE
		1:200, 1:2000				



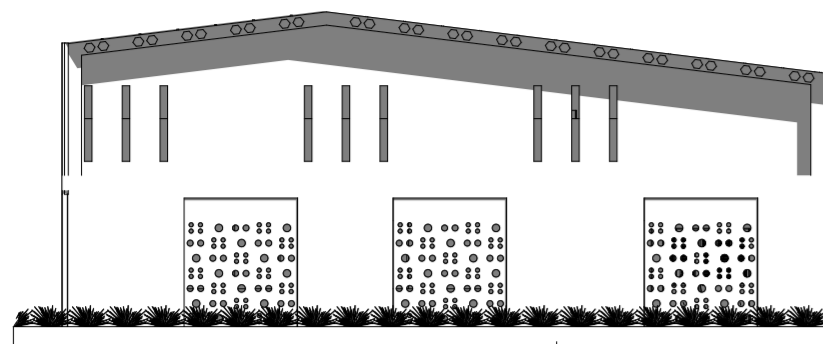

BATAKO
BATAKO BERONGGA

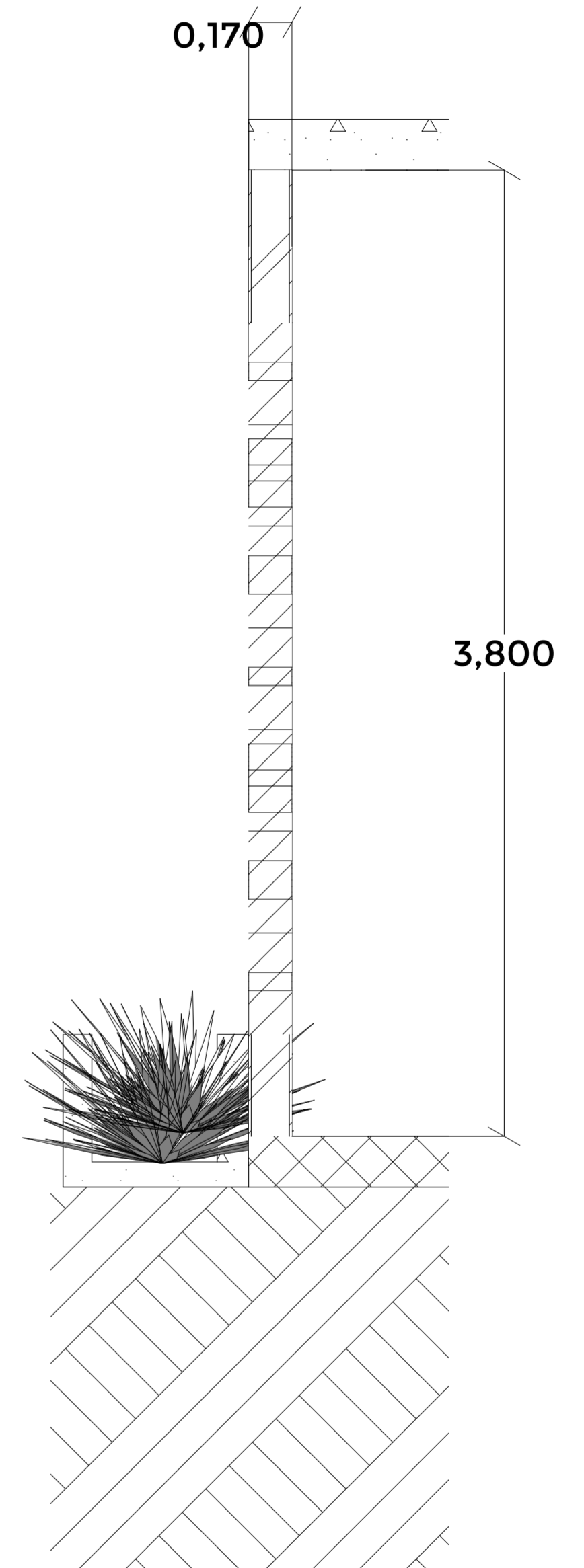
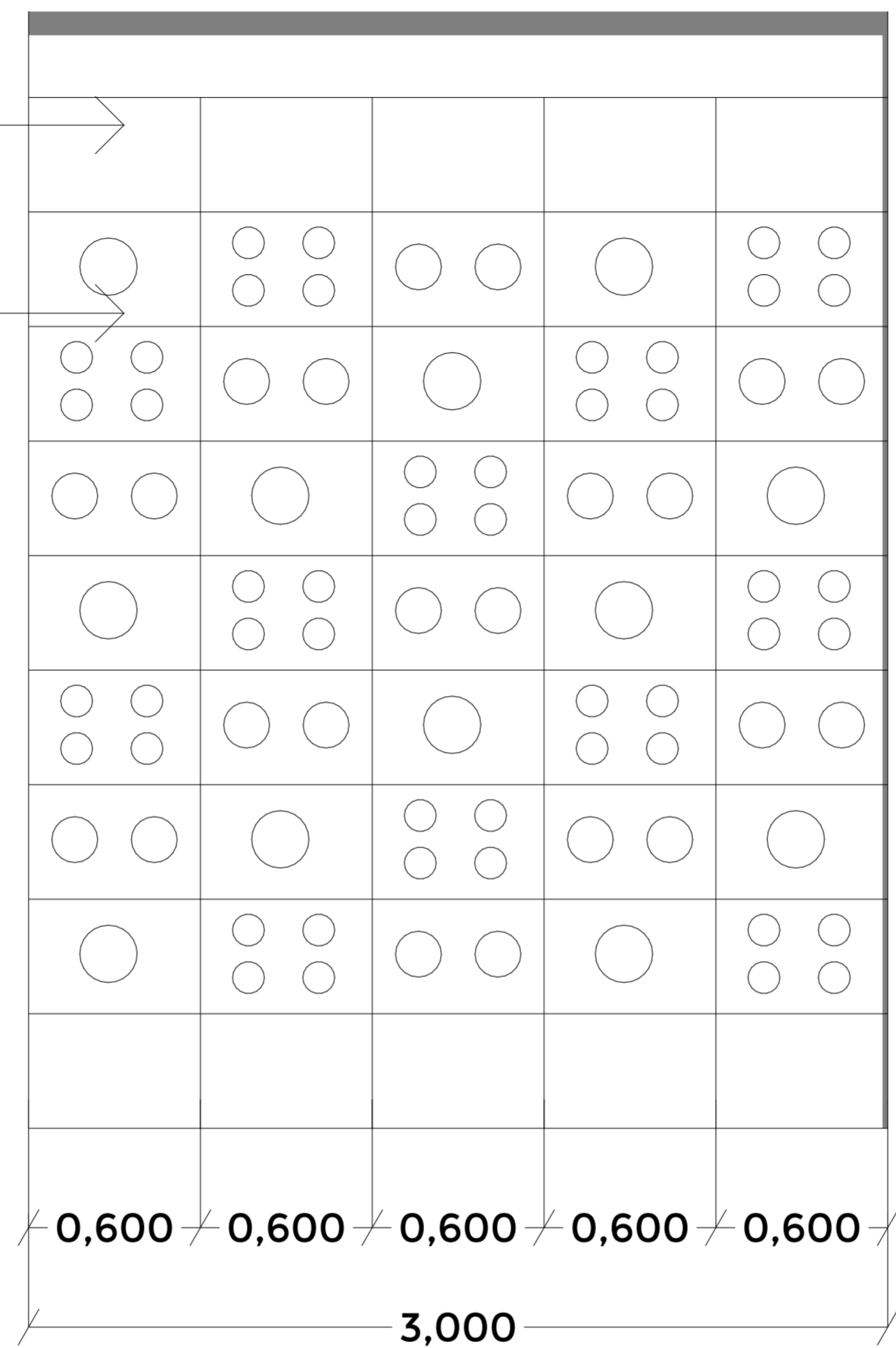

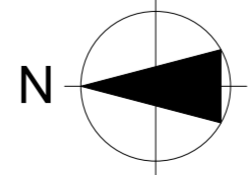
PROJECT	LOCATION	DRAWING NAME	DRAWING BY	DESCRIPTION	NOTES	PAGE	 JURUSAN ARSITEKTUR FAKULTAS TEKNIK SIPIL DAN PERENCANAAN UNIVERSITAS ISLAM INDONESIA
Bachelor Final Project "WASTE LIVING LABORATORY PIYUNGAN"	TPST Piyungan Ngablak, Sitimulyo, Piyungan, Bantul, DIY	Detail selubung bangunan, Potongan dinding berongga	Fairuz Rana Zhavira 14512017			TOTAL PAGE	

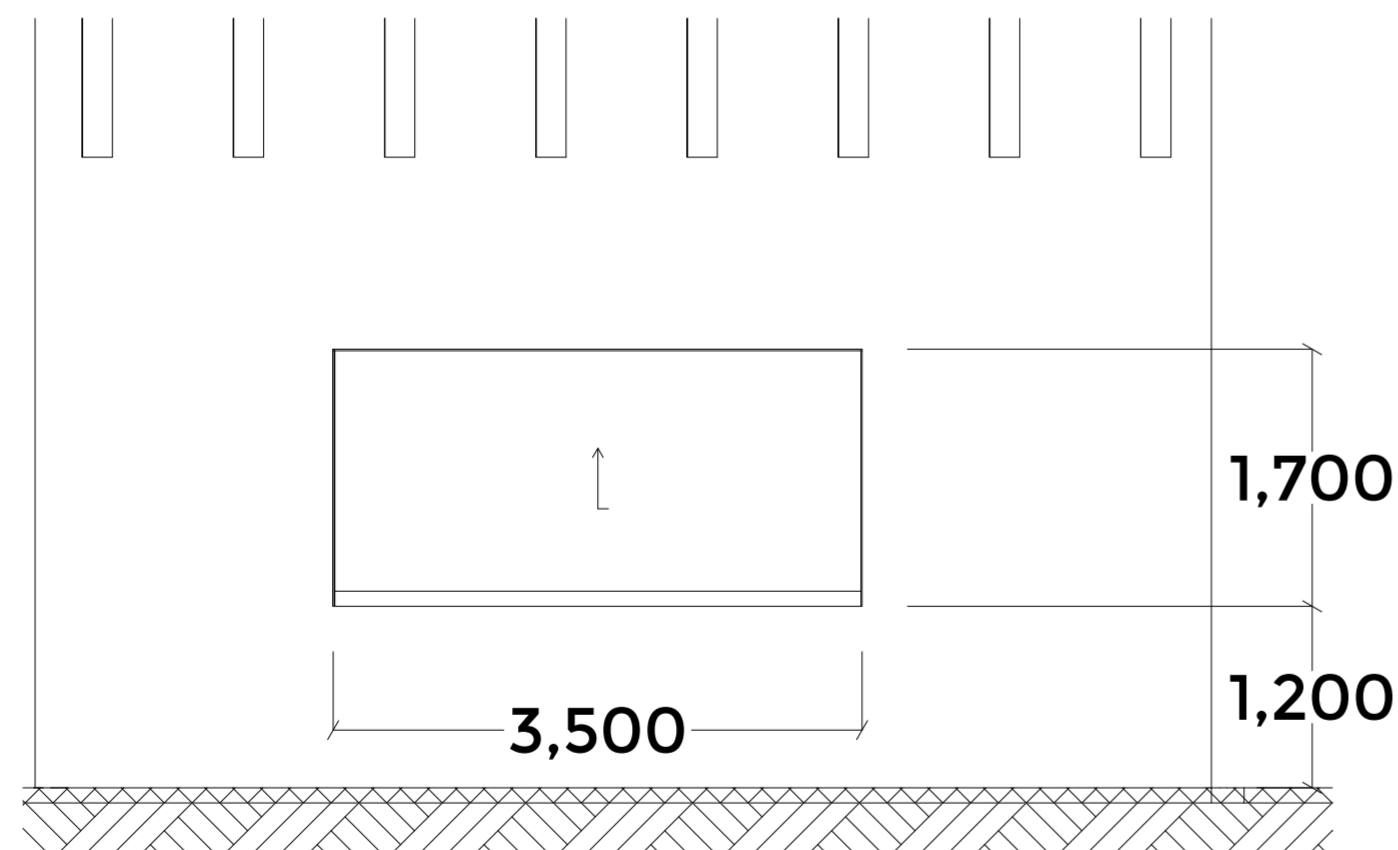
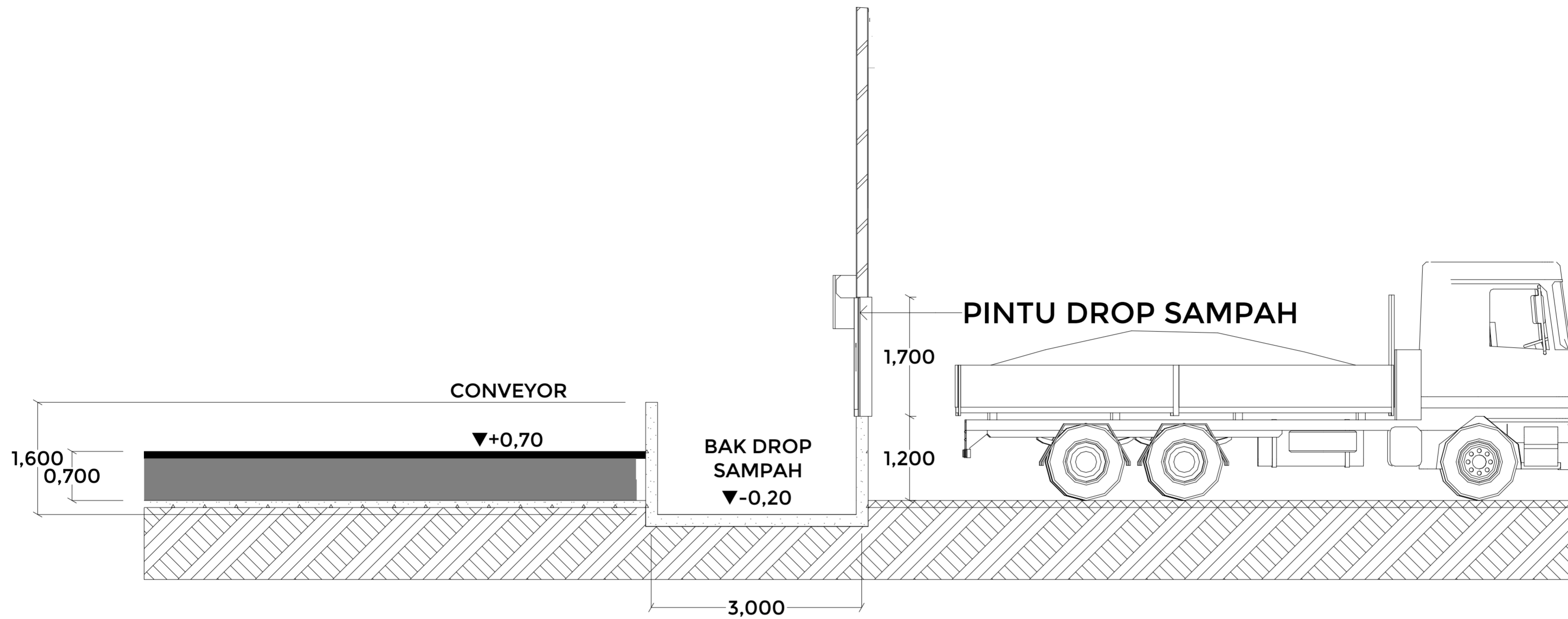

PROJECT	LOCATION	DRAWING NAME	DRAWING BY	DESCRIPTION	NOTES	PAGE
Barchelor Final Project "WASTE LIVING LABORATORY PIYUNGAN"	TPST Piyungan Ngablak, Sitimulyo, Piyungan, Bantul, DIY	Detail drop sampah, Tampak pintu drop	Fairuz Rana Zhavira 14512017			
		SCALE				TOTAL PAGE
		1:50				

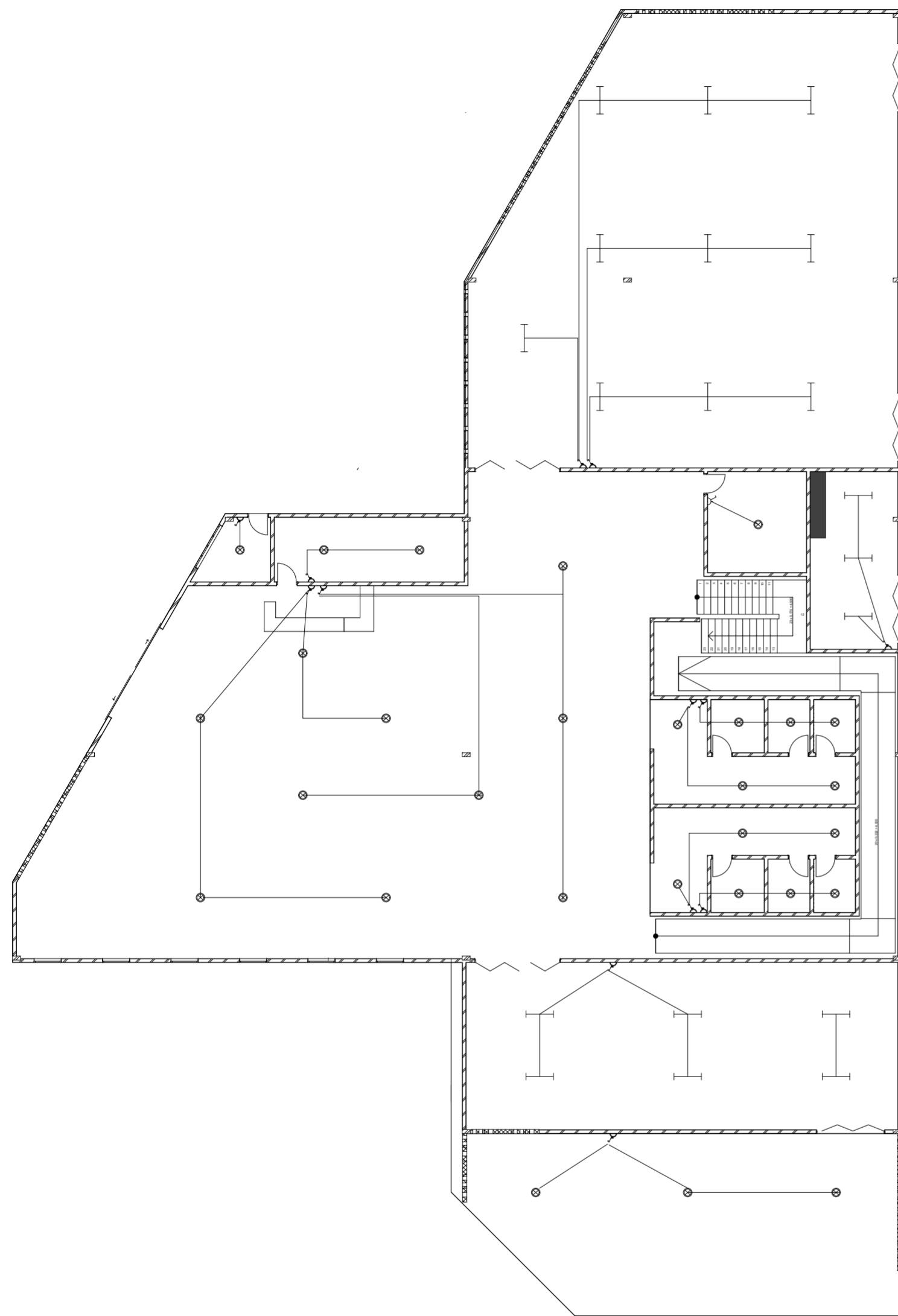

Titik lampu lab. workshop

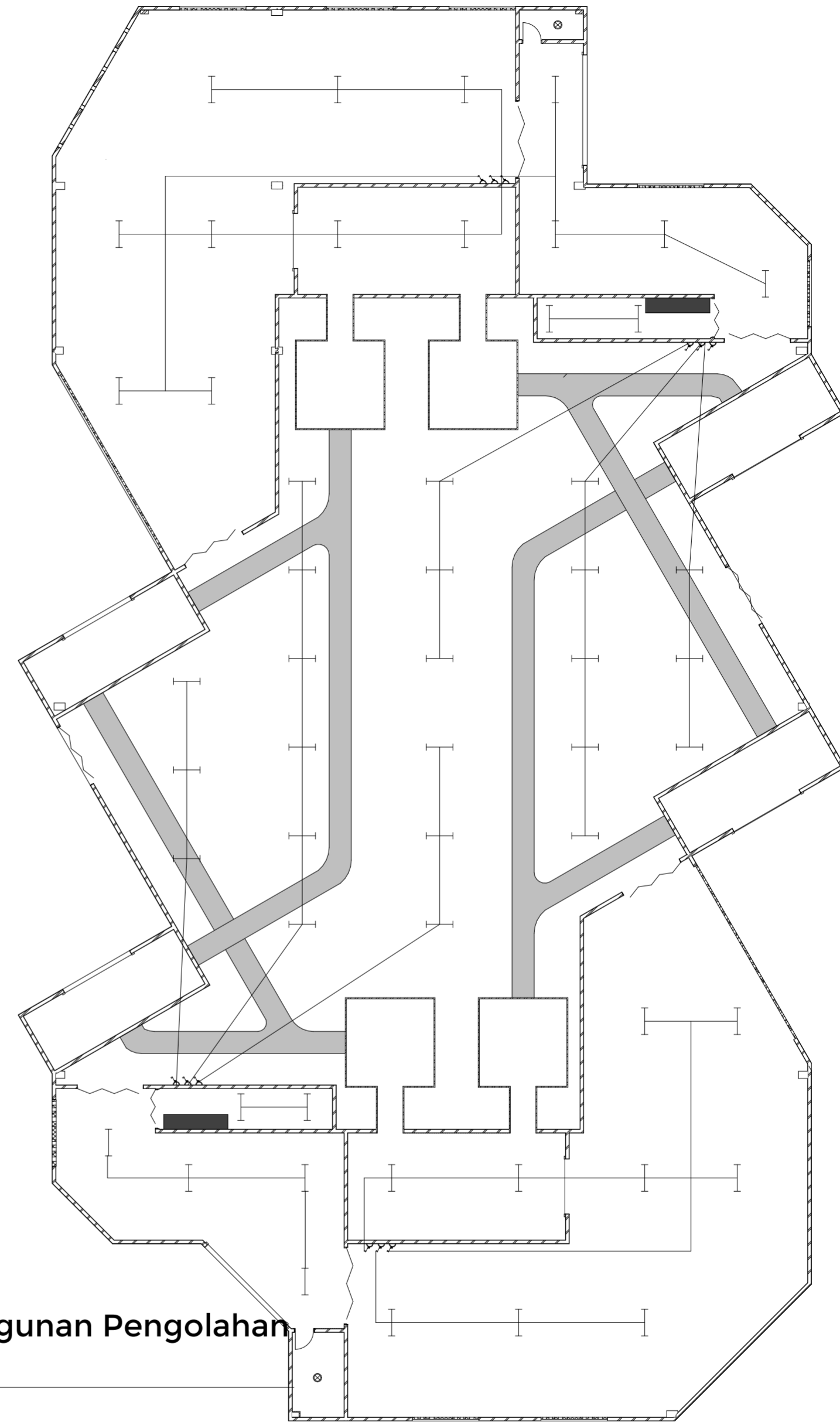



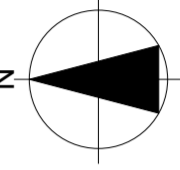
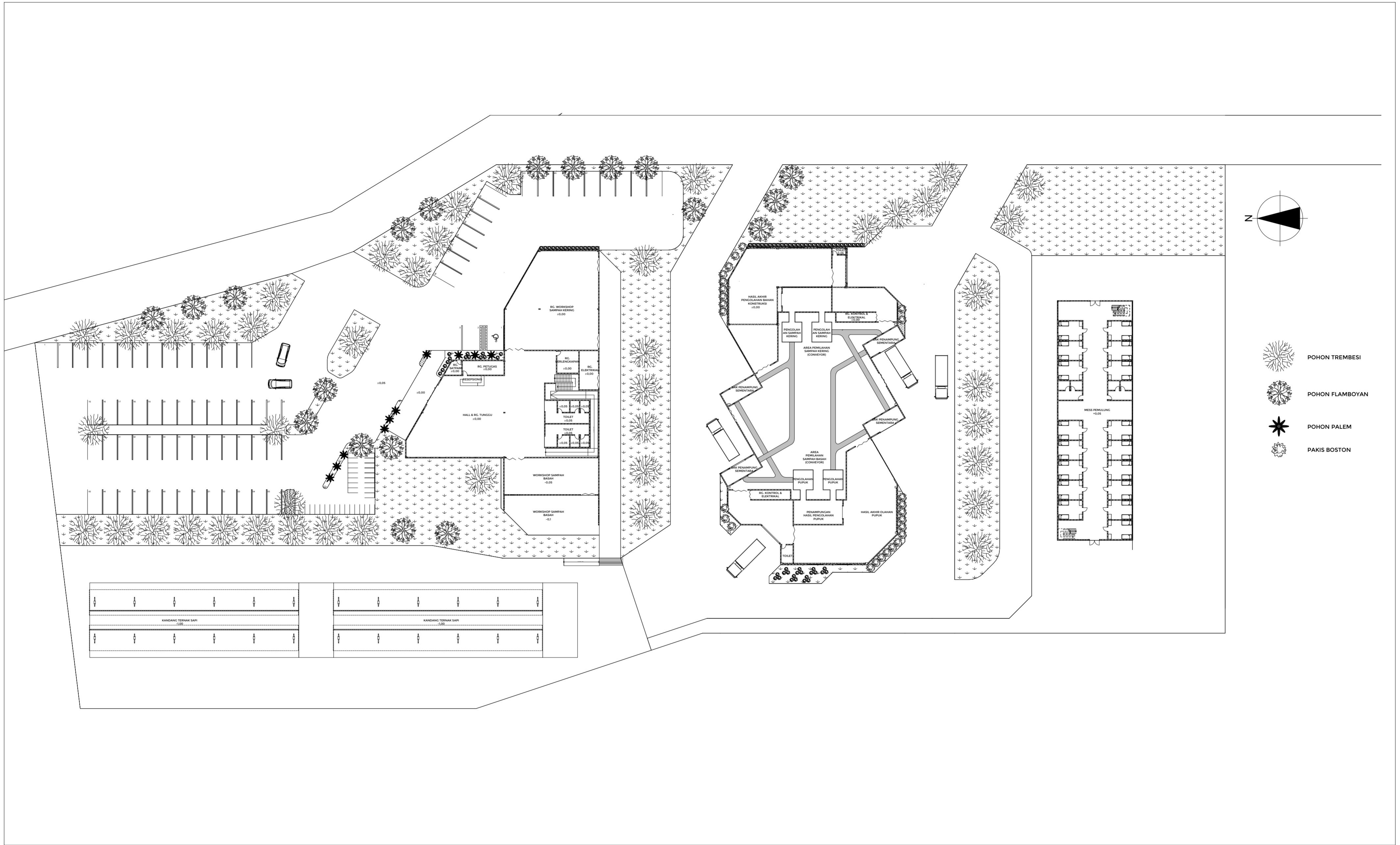

Titik Lampu Bangunan Pengolahan Sampah

PROJECT	LOCATION	DRAWING NAME	DRAWING BY	DESCRIPTION	NOTES	PAGE
Bachelor Final Project "WASTE LIVING LABORATORY PIYUNGAN"	TPST Piyungan Ngablak, Sitimulyo, Piyungan, Bantul, DIY	Rencana titik lampu	Fairuz Rana Zhavira 14512017	 <ul style="list-style-type: none">  LED Bulb Lamp  Fluorescent Lamp  Power Distribution  Power Source 		
		SCALE				TOTAL PAGE
		1:200				



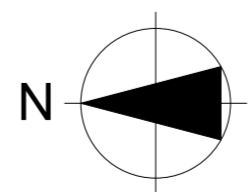

-  POHON TREMBESI
-  POHON FLAMBOYAN
-  POHON PALEM
-  PAKIS BOSTON

PROJECT	LOCATION	DRAWING NAME	DRAWING BY	DESCRIPTION	NOTES	PAGE
Bachelor Final Project "WASTE LIVING LABORATORY PIYUNGAN"	TPST Piyungan Ngablak, Sitimulyo, Piyungan, Bantul, DIY	Siteplan	Fairuz Rana Zhavira 14512017			
		SCALE				TOTAL PAGE
		1:500				

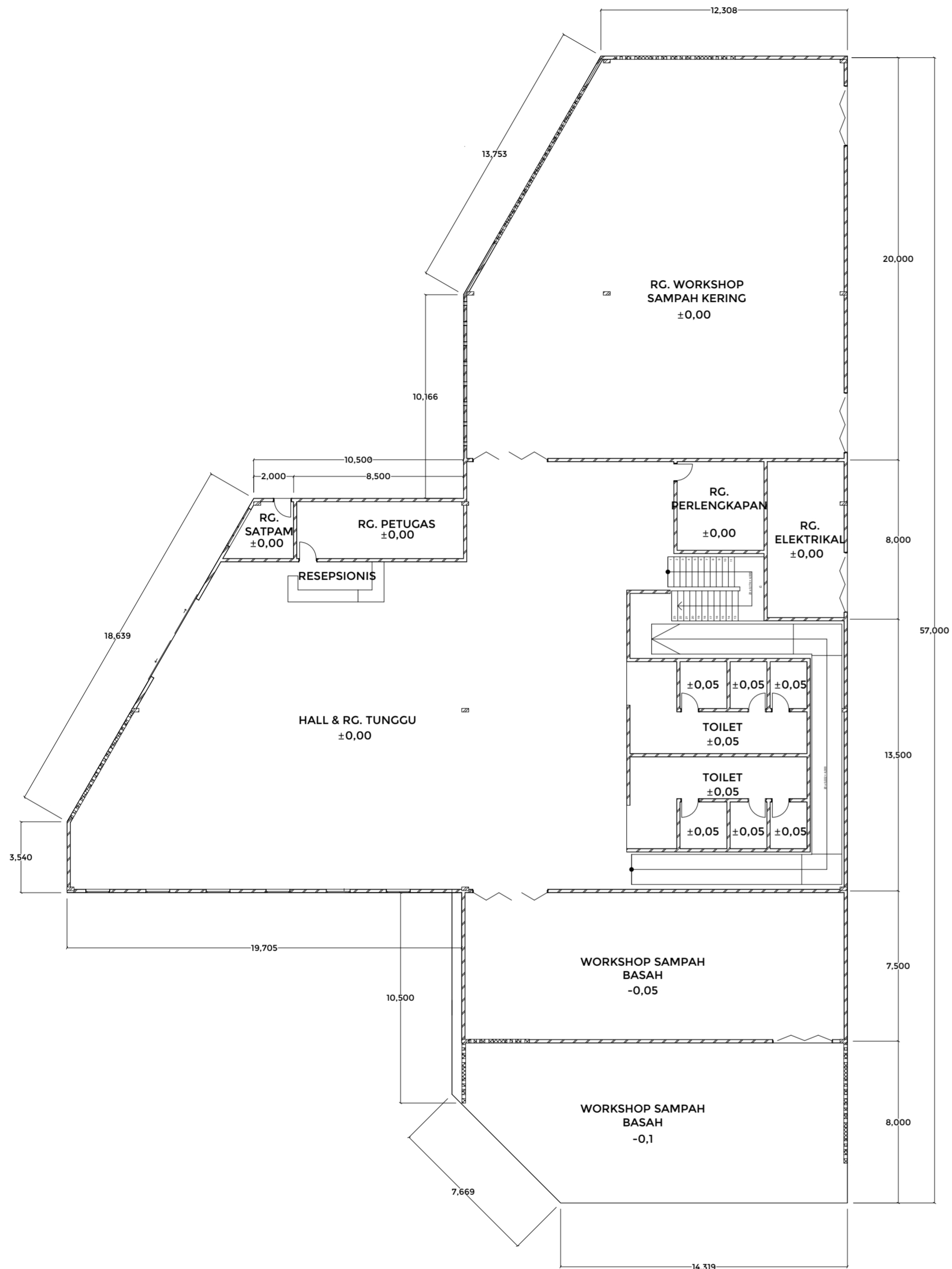

Denah Lt.1 Lab. Workshop

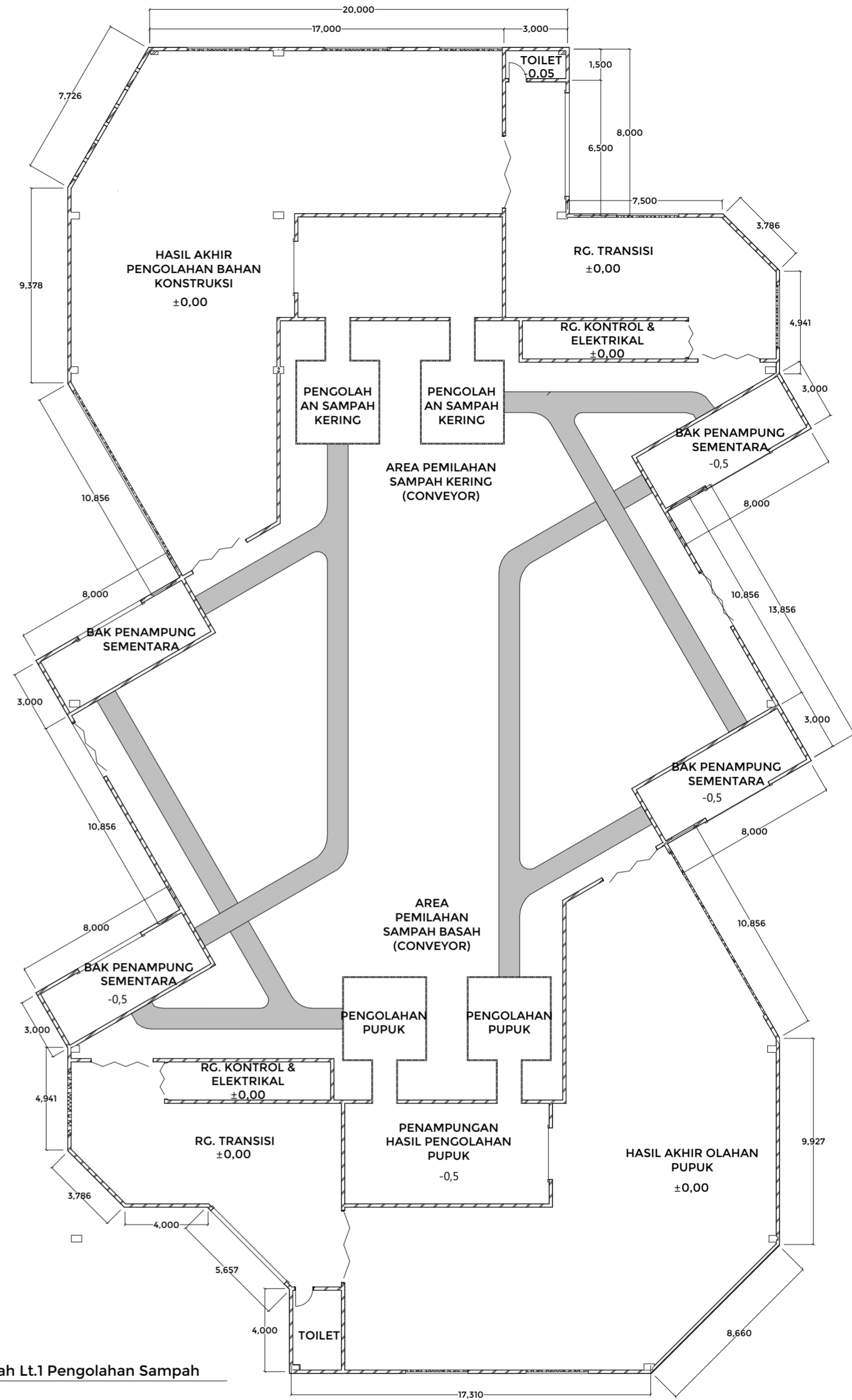

Denah Lt.1 Pengolahan Sampah

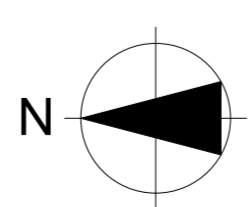
PROJECT	LOCATION	DRAWING NAME	DRAWING BY	DESCRIPTION	NOTES	PAGE
Bachelor Final Project "WASTE LIVING LABORATORY PIYUNGAN"	TPST Piyungan Ngablak, Sitimulyo, Piyungan, Bantul, DIY	Denah Lt.1 Lab. Workshop	Fairuz Rana Zhavira 14512017			
		Denah Lt.1 Pengolahan Sampah				
		1:200				
						TOTAL PAGE



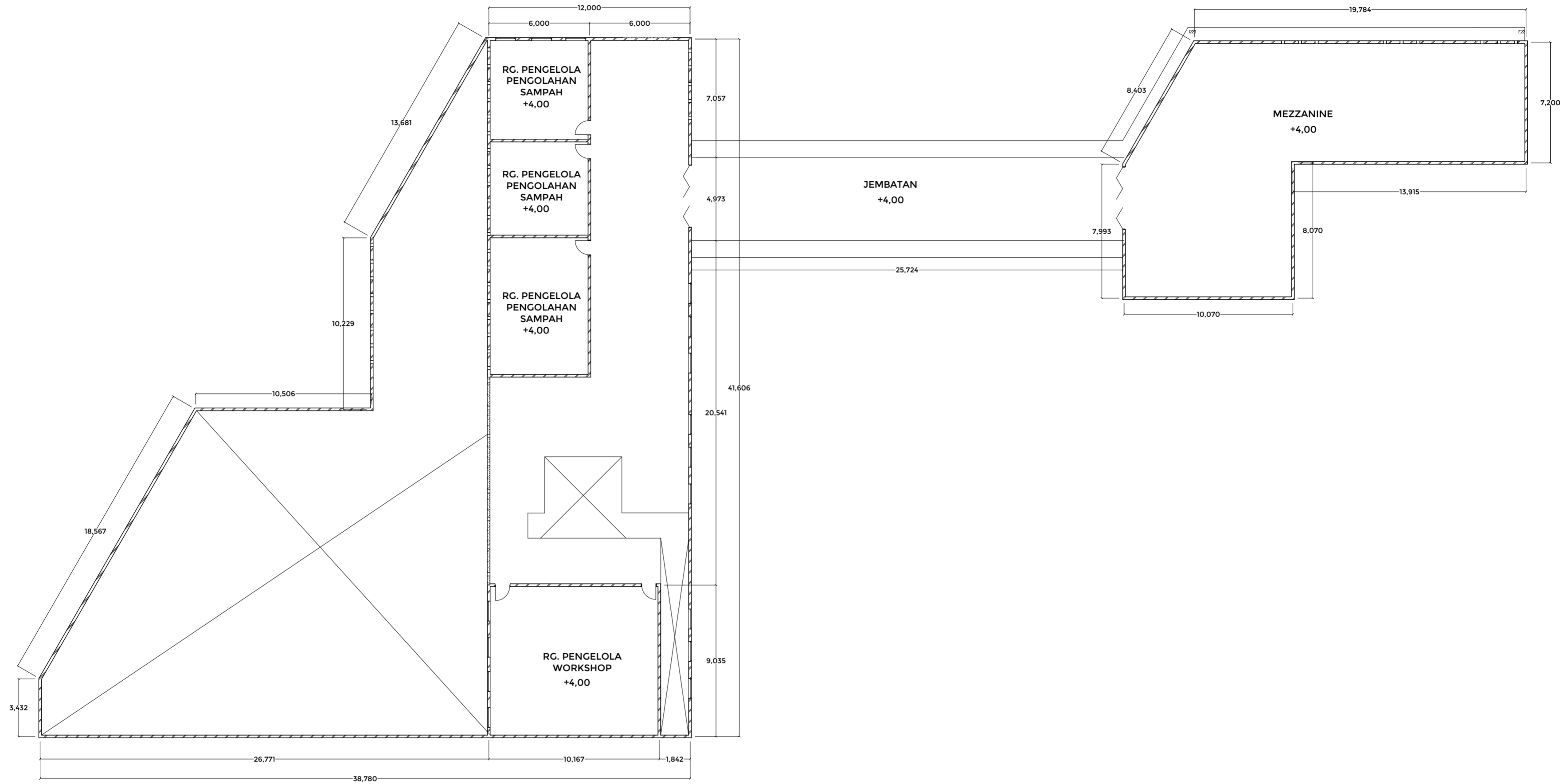

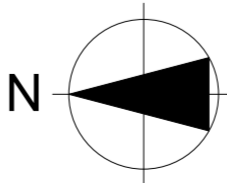
PROJECT	LOCATION	DRAWING NAME	DRAWING BY	DESCRIPTION	NOTES	PAGE
Barchelor Final Project "WASTE LIVING LABORATORY PIYUNGAN"	TPST Piyungan Ngablak, Sitimulyo, Piyungan, Bantul, DIY	Denah Lt. 2	Fairuz Rana Zhavira 14512017			
		SCALE				TOTAL PAGE
		1:200				



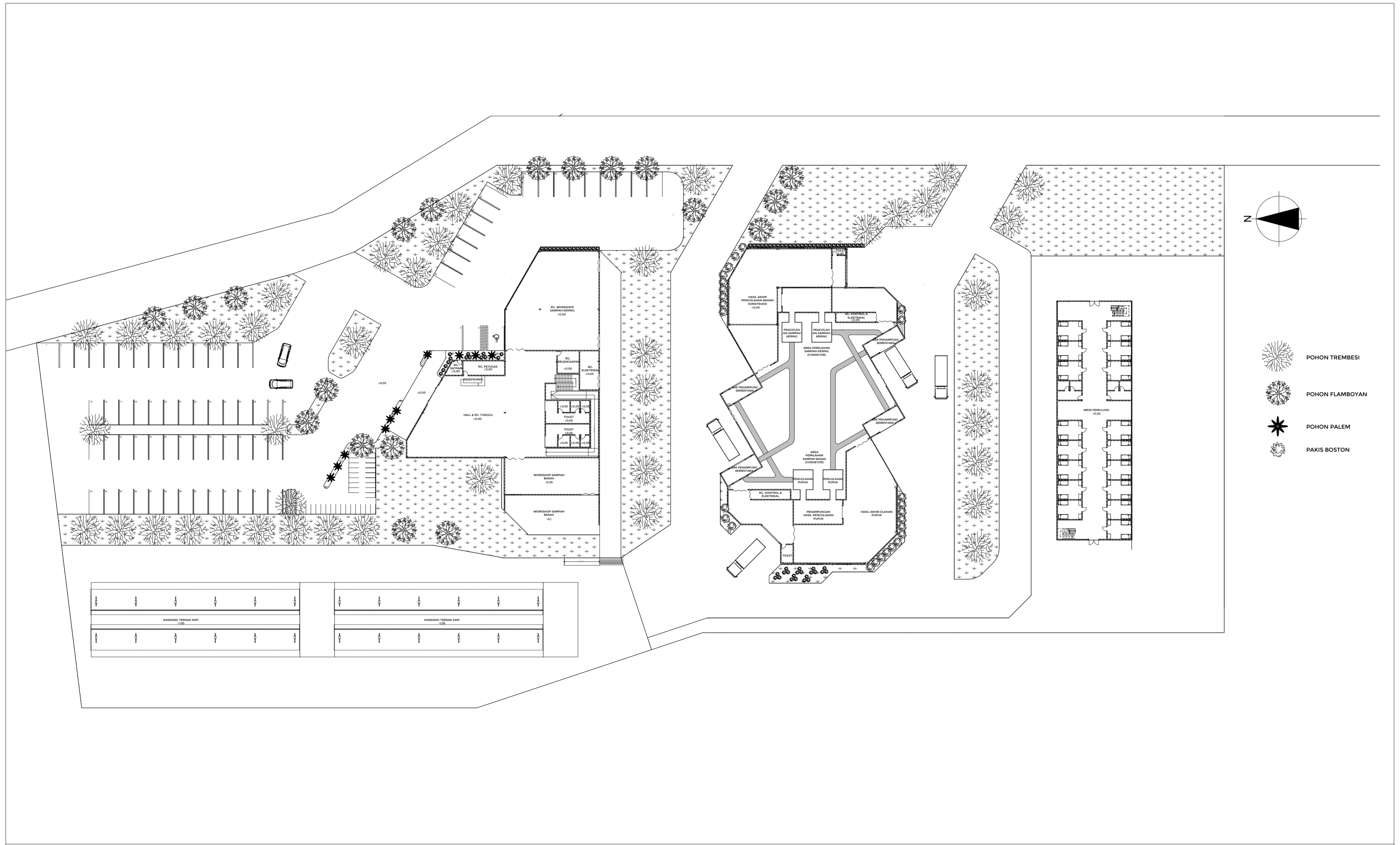

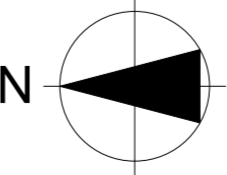
PROJECT	LOCATION	DRAWING NAME	DRAWING BY	DESCRIPTION	NOTES	PAGE	 JURUSAN ARSITEKTUR FAKULTAS TEKNIK SIPIL DAN PERENCANAAN UNIVERSITAS ISLAM INDONESIA
Bachelor Final Project "WASTE LIVING LABORATORIUM PIYUNGAN"	TPST Piyungan Ngablak, Sitimulyo, Piyungan, Bantul, DIY	Siteplan	Fairuz Rana Zhavira 14512017				
		SCALE				TOTAL PAGE	
		1:500					

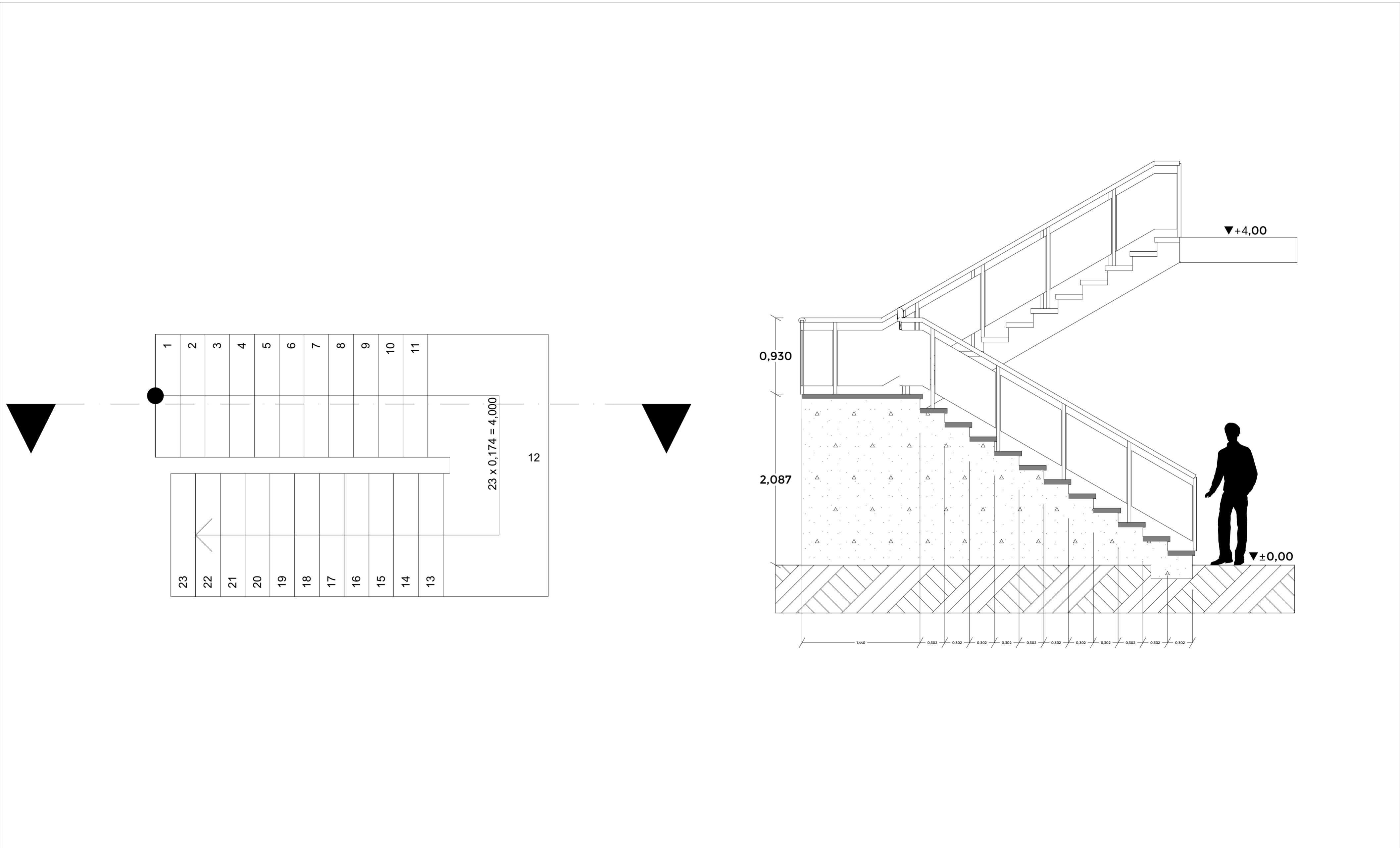

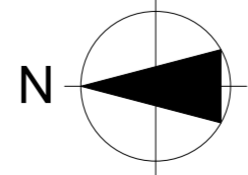
PROJECT	LOCATION	DRAWING NAME	DRAWING BY	DESCRIPTION	NOTES	PAGE
Barchelor Final Project "WASTE LIVING LABORATORY PIYUNGAN"	TPST Piyungan Ngablak, Sitimulyo, Piyungan, Bantul, DIY	Skema Transportasi vertikal	Fairuz Rana Zhavira 14512017			
		SCALE				TOTAL PAGE



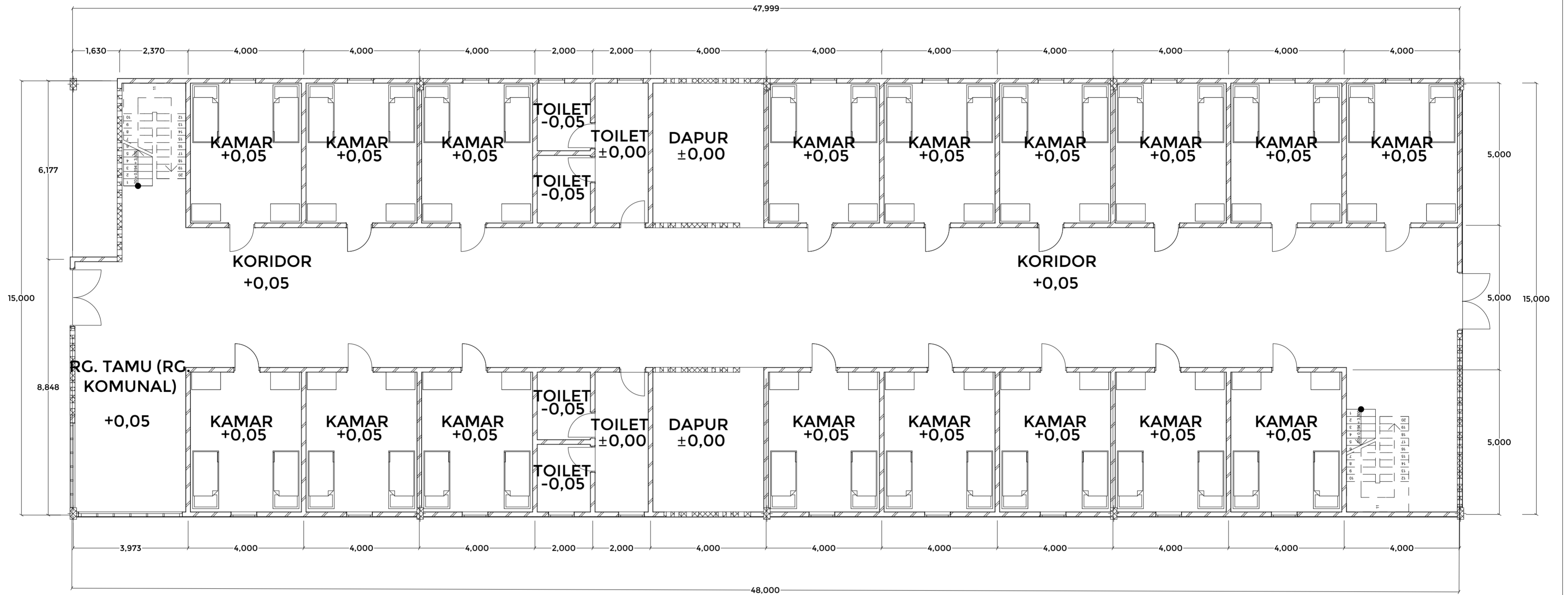

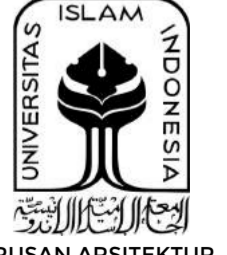
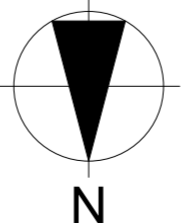
PROJECT	LOCATION	DRAWING NAME	DRAWING BY	DESCRIPTION	NOTES	PAGE	 JURUSAN ARSITEKTUR FAKULTAS TEKNIK SIPIL DAN PERENCANAAN UNIVERSITAS ISLAM INDONESIA
Bachelor Final Project "WASTE LIVING LABORATORY PIYUNGAN"	TPST Piyungan Ngablak, Sitimulyo, Piyungan, Bantul, DIY	Denah Mess Lt. 1	Fairuz Rana Zhavira 14512017	 N		TOTAL PAGE	
		SCALE					
		1:100					

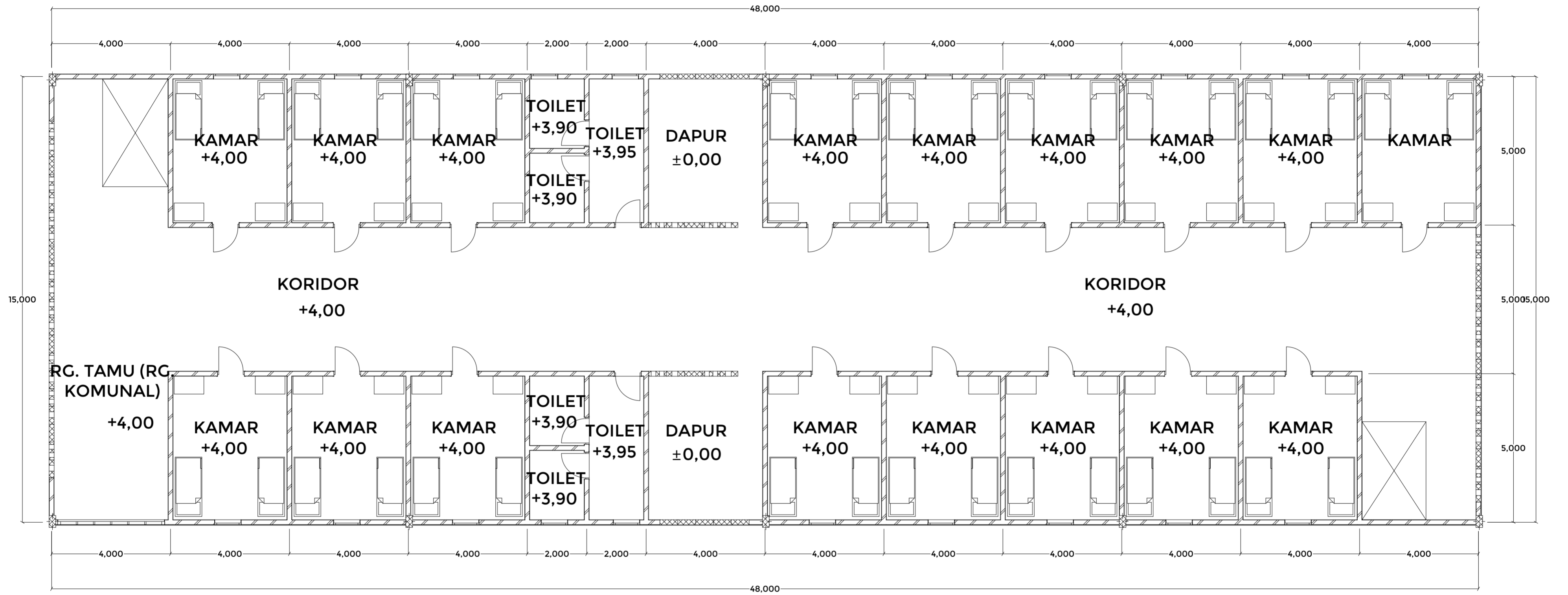

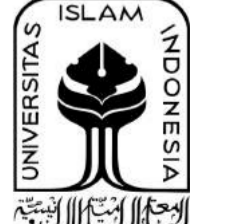
PROJECT	LOCATION	DRAWING NAME	DRAWING BY	DESCRIPTION	NOTES	PAGE	 JURUSAN ARSITEKTUR FAKULTAS TEKNIK SIPIL DAN PERENCANAAN UNIVERSITAS ISLAM INDONESIA
Barchelor Final Project "WASTE LIVING LABORATORY PIYUNGAN"	TPST Piyungan Ngablak, Sitimulyo, Piyungan, Bantul, DIY	Denah Mess Lt. 2	Fairuz Rana Zhavira 14512017	 N			
		SCALE					
		1:100				TOTAL PAGE	

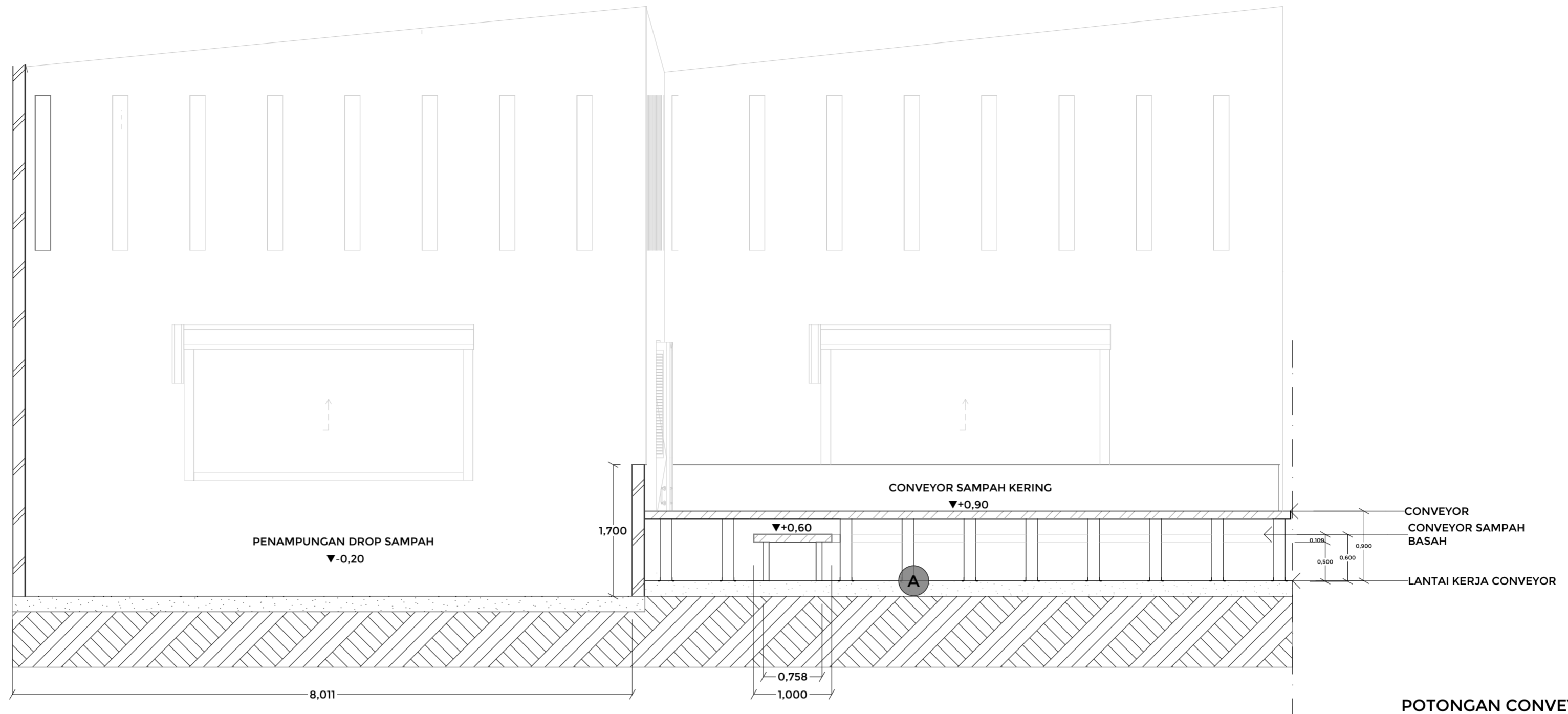
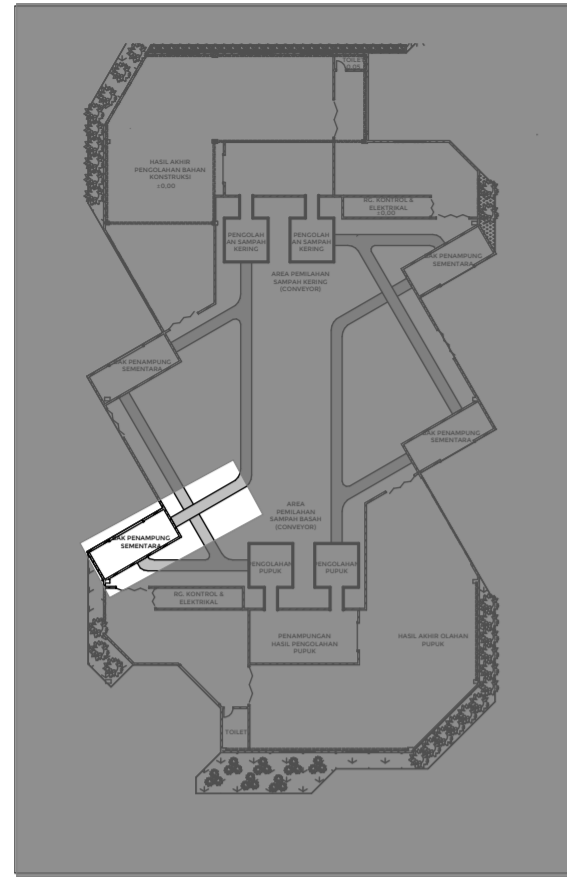

POTONGAN CONVEYOR
1:50

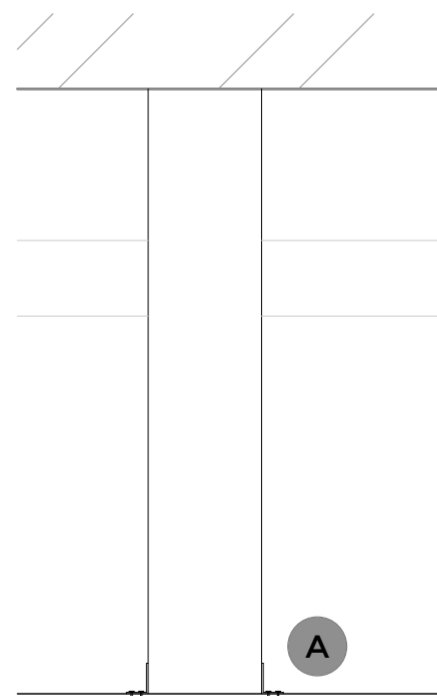

DETAIL SAMBUNGAN
1:10

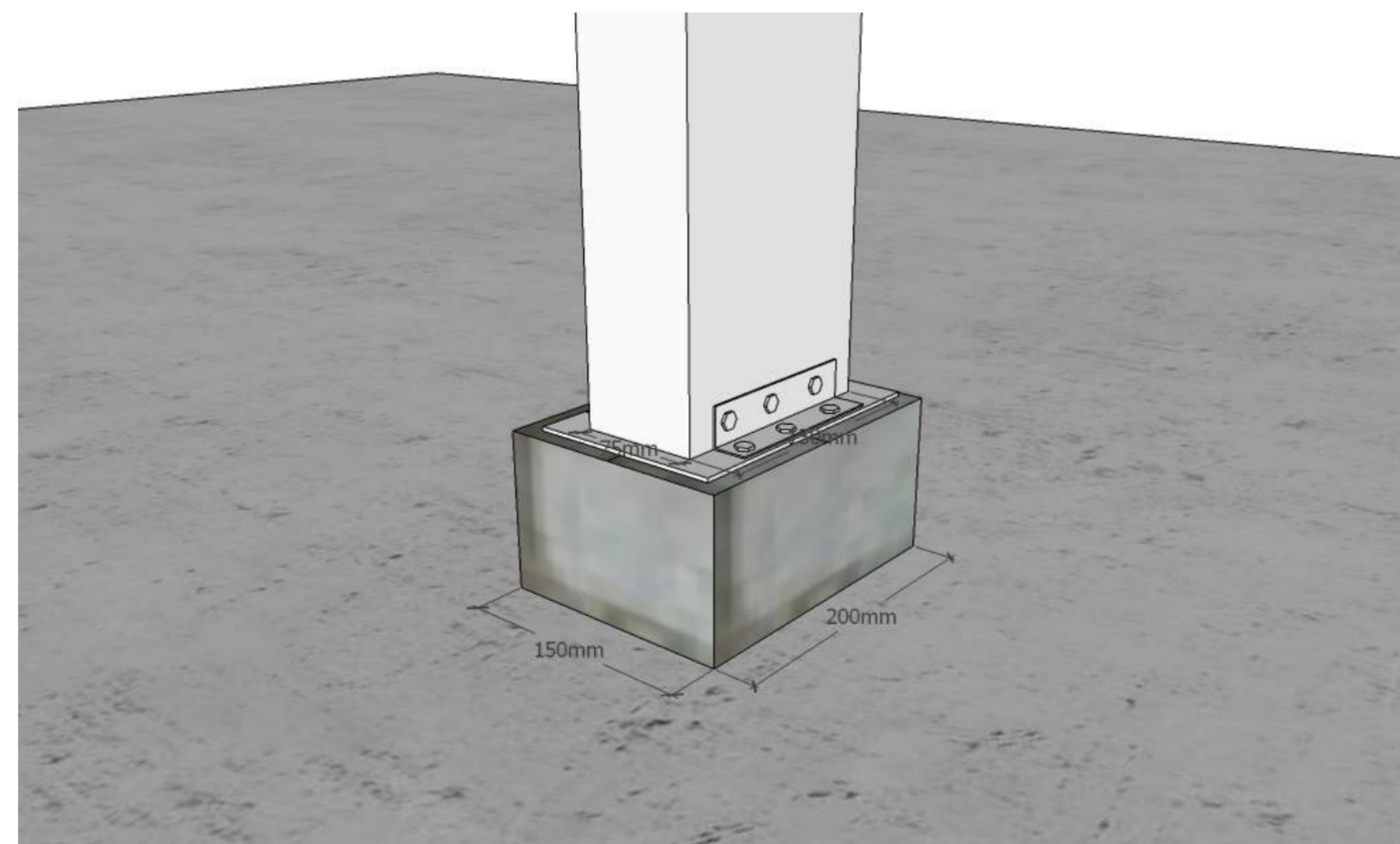

AKSONOMETRI DETAIL SAMBUNGAN

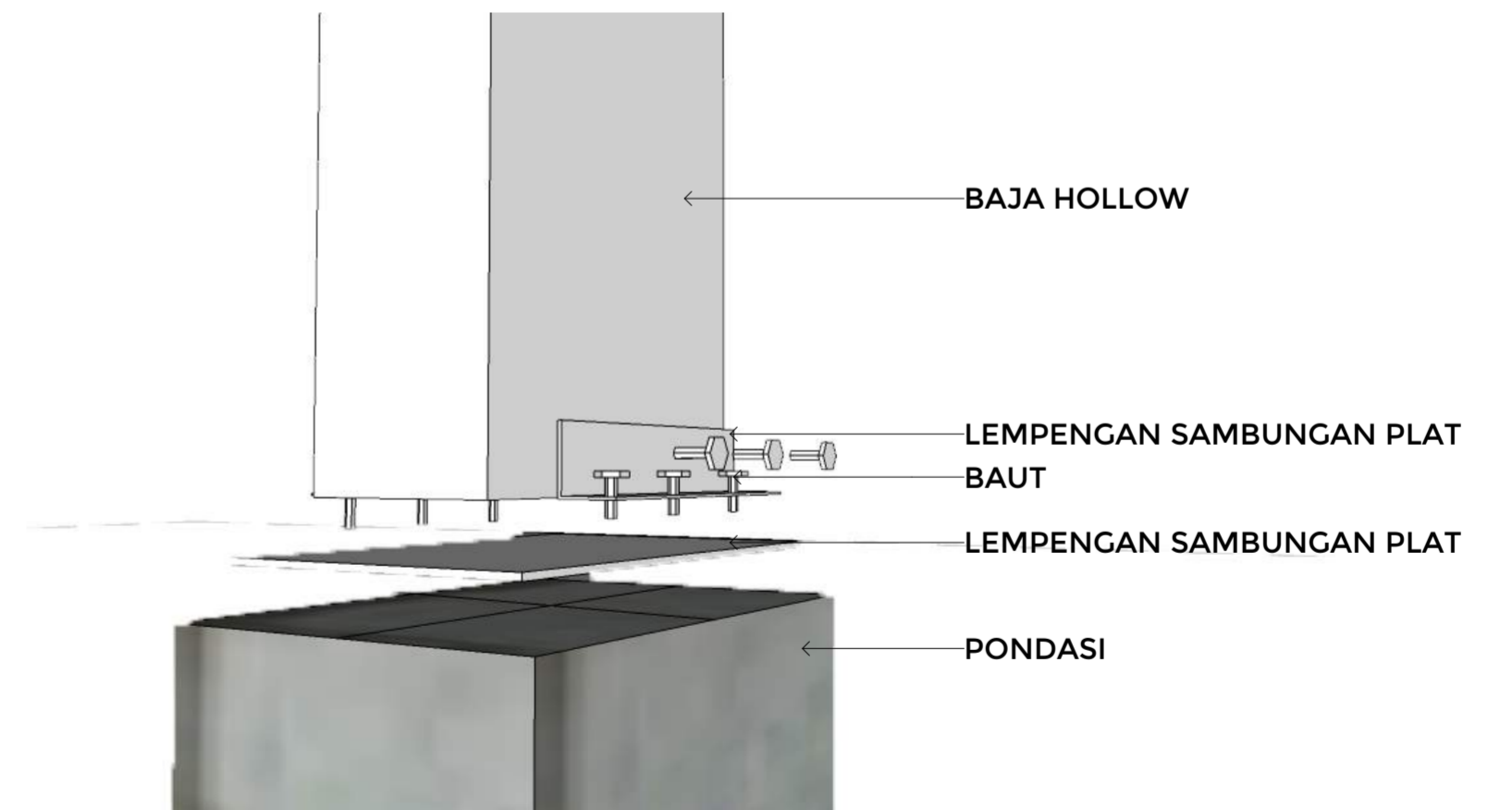

PROJECT	LOCATION	DRAWING NAME	DRAWING BY	DESCRIPTION	NOTES	PAGE	 JURUSAN ARSITEKTUR FAKULTAS TEKNIK SIPIL DAN PERENCANAAN UNIVERSITAS ISLAM INDONESIA
Bachelor Final Project "WASTE LIVING LABORATORY PIYUNGAN"	TPST Piyungan Ngablak, Sitimulyo, Piyungan, Bantul, DIY	DETAIL INTERIOR KHUSUS	Fairuz Rana Zhavira 14512017			TOTAL PAGE	
		SCALE					
		1:50, 1:10					

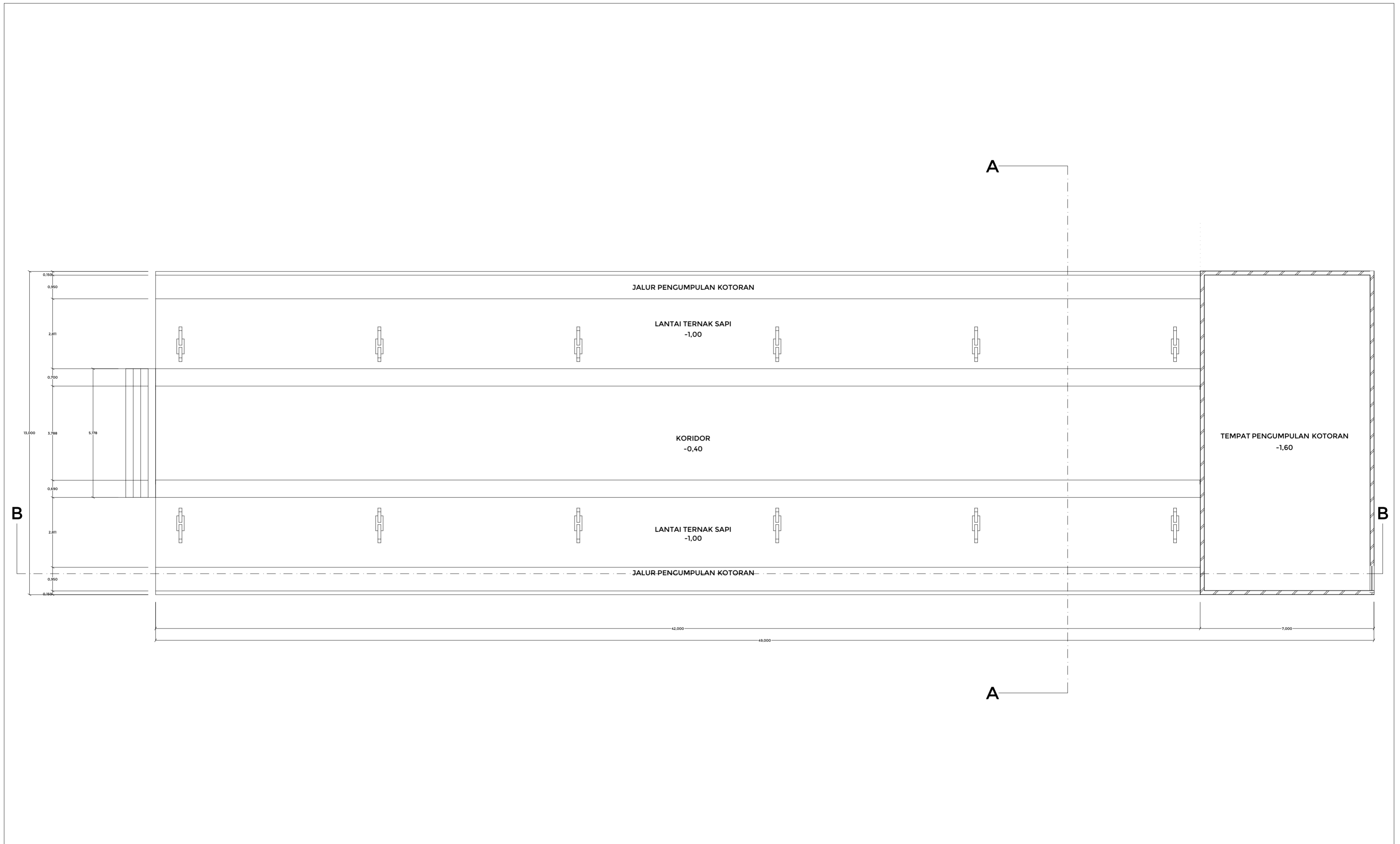

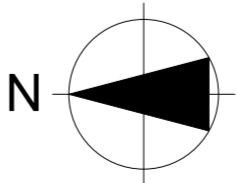
PROJECT	LOCATION	DRAWING NAME	DRAWING BY	DESCRIPTION	NOTES	PAGE
Bachelor Final Project "WASTE LIVING LABORATORY PIYUNGAN"	TPST Piyungan Ngablak, Sitimulyo, Piyungan, Bantul, DIY	Denah Kandang Sapi	Fairuz Rana Zhavira 14512017			
		SCALE				TOTAL PAGE
		1:100				



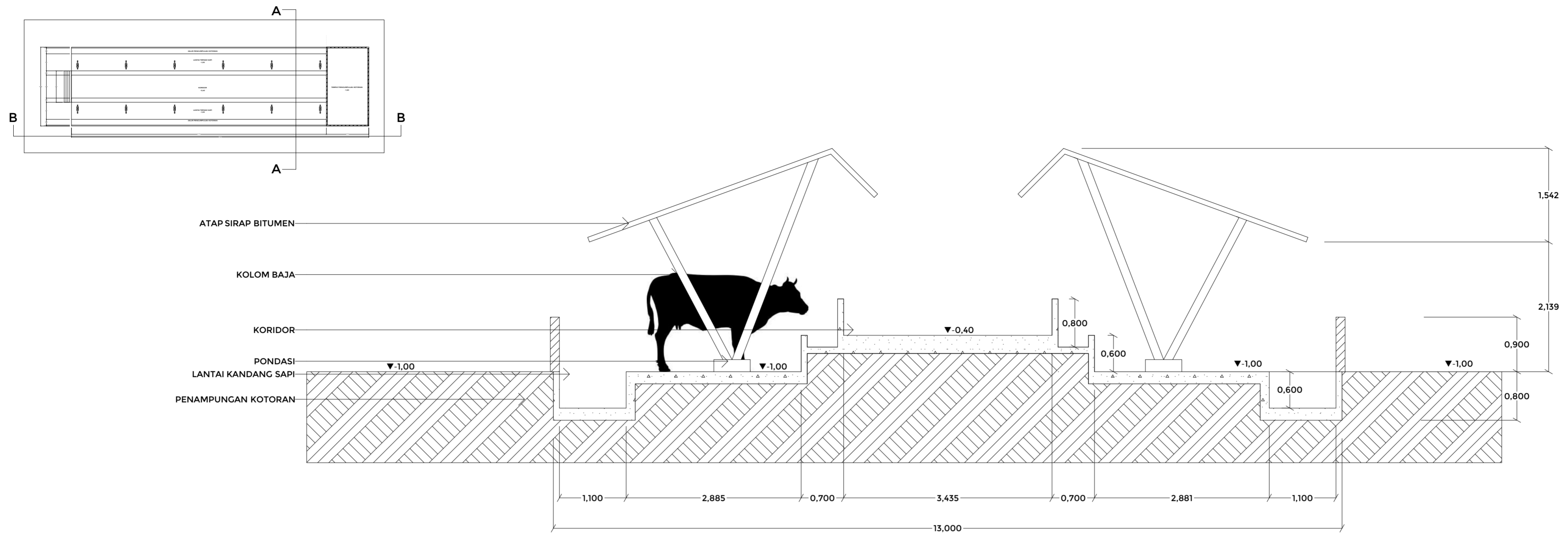

Potongan Kandang A
1:50

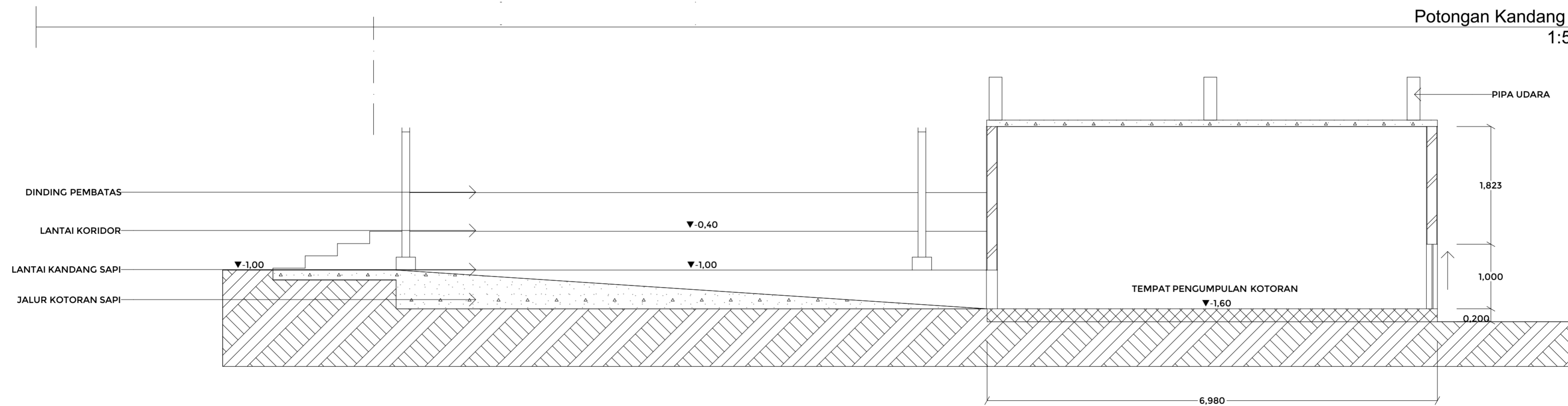

Potongan Kandang B
1:50

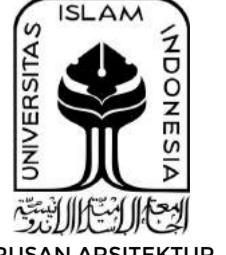
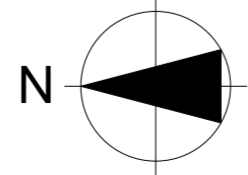
PROJECT	LOCATION	DRAWING NAME	DRAWING BY	DESCRIPTION	NOTES	PAGE	 JURUSAN ARSITEKTUR FAKULTAS TEKNIK SIPIL DAN PERENCANAAN UNIVERSITAS ISLAM INDONESIA
Bachelor Final Project "WASTE LIVING LABORATORY PIYUNGAN"	TPST Piyungan Ngablak, Sitimulyo, Piyungan, Bantul, DIY	Detail penyelesaian khusus (Pengumpulan kotoran sapi)	Fairuz Rana Zhavira 14512017			TOTAL PAGE	
		SCALE					
		1:50, 1:500					

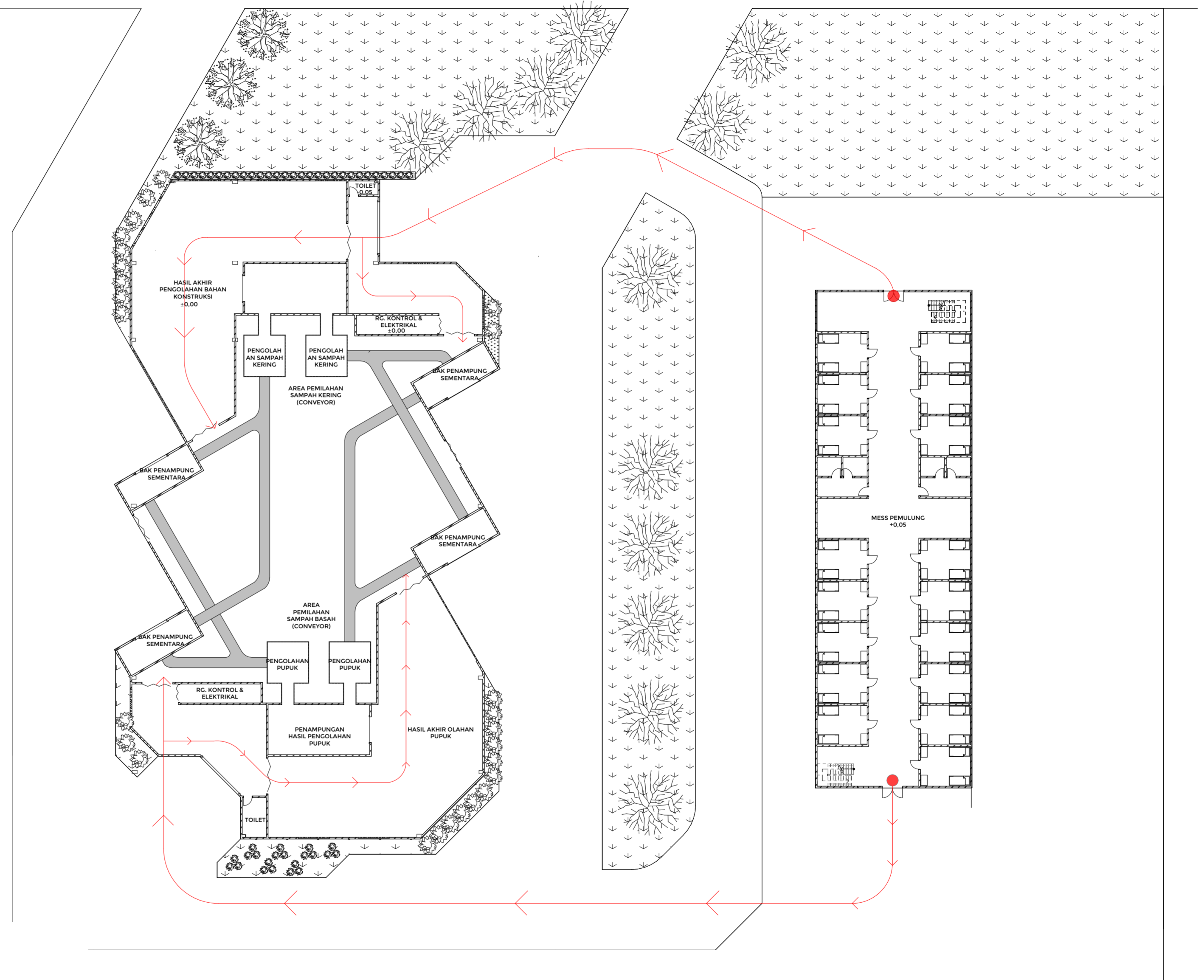
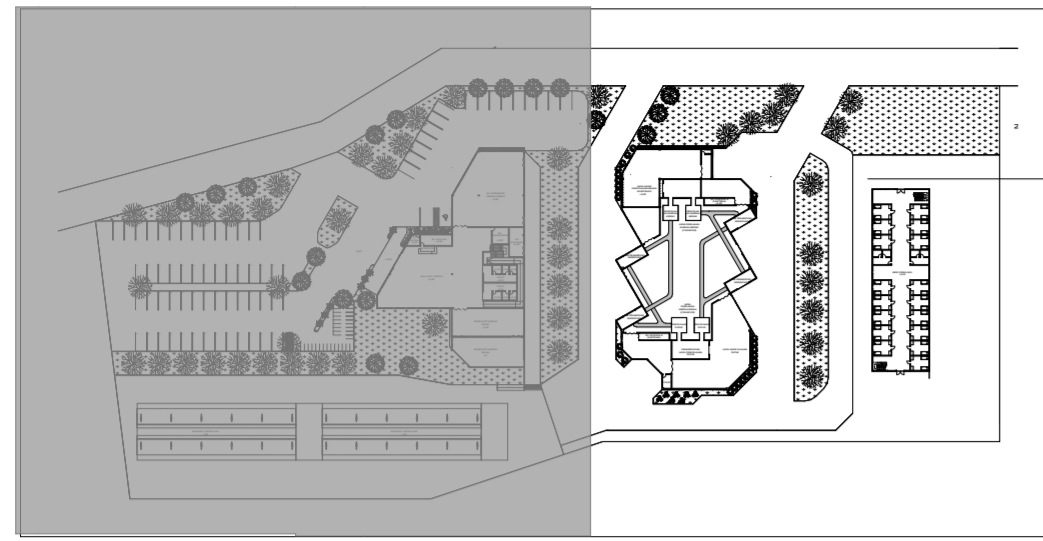

PROJECT	LOCATION	DRAWING NAME	DRAWING BY	DESCRIPTION	NOTES	PAGE
Bachelor Final Project "WASTE LIVING LABORATORY PIYUNGAN"	TPST Piyungan Ngablak, Sitimulyo, Piyungan, Bantul, DIY	Skema akses pemulung, Siteplan	Fairuz Rana Zhavira 14512017			
		SCALE				TOTAL PAGE



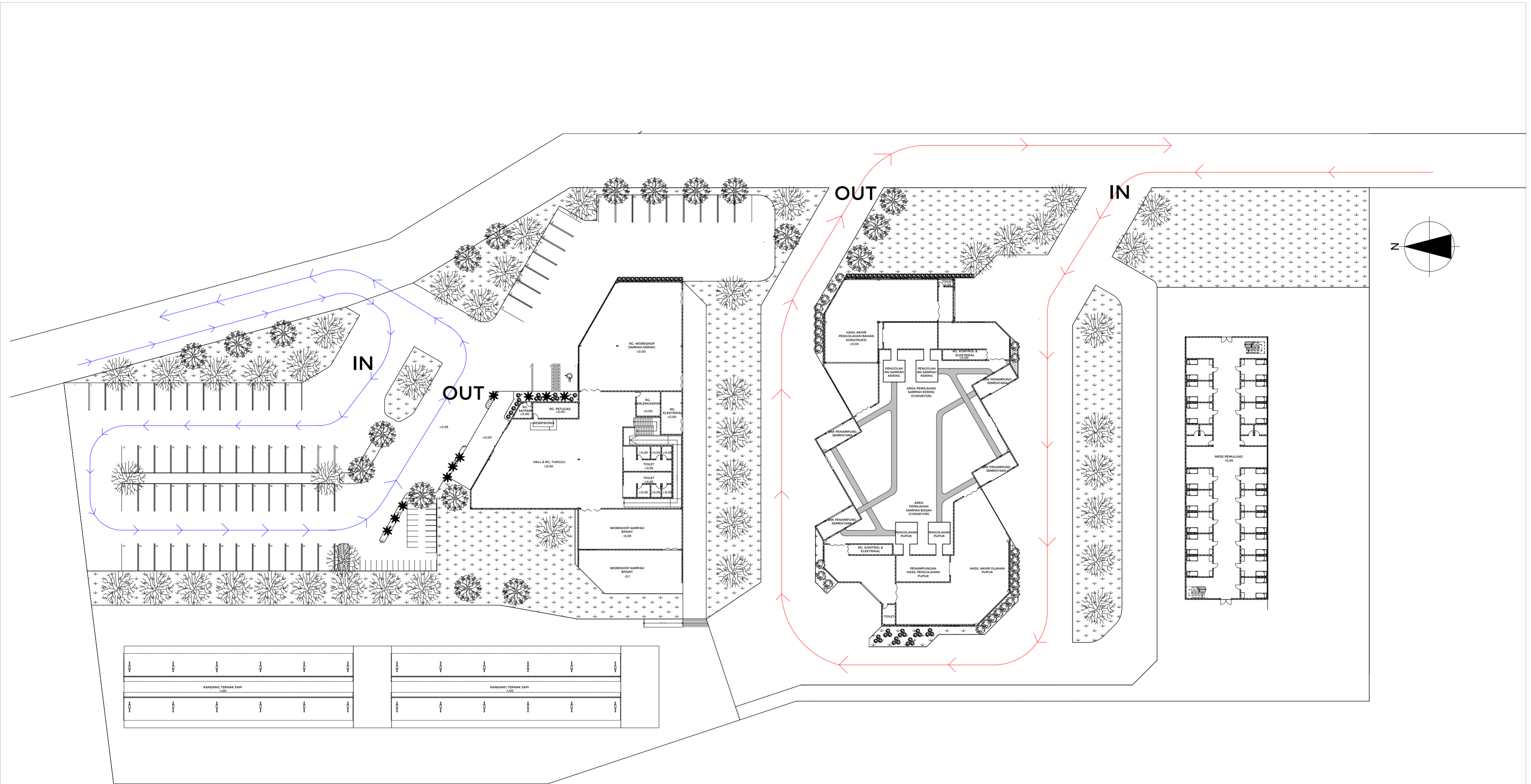

PROJECT	LOCATION	DRAWING NAME	DRAWING BY	DESCRIPTION	NOTES	PAGE
Bachelor Final Project "WASTE LIVING LABORATORY PIYUNGAN"	TPST Piyungan Ngablak, Sitimulyo, Piyungan, Bantul, DIY	Skema arah masuk dan keluar kendaraan	Fairuz Rana Zhavira 14512017			
		SCALE				TOTAL PAGE
		1:500				



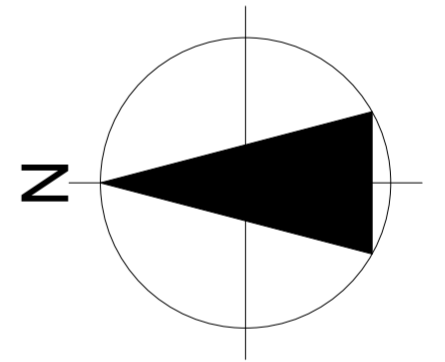
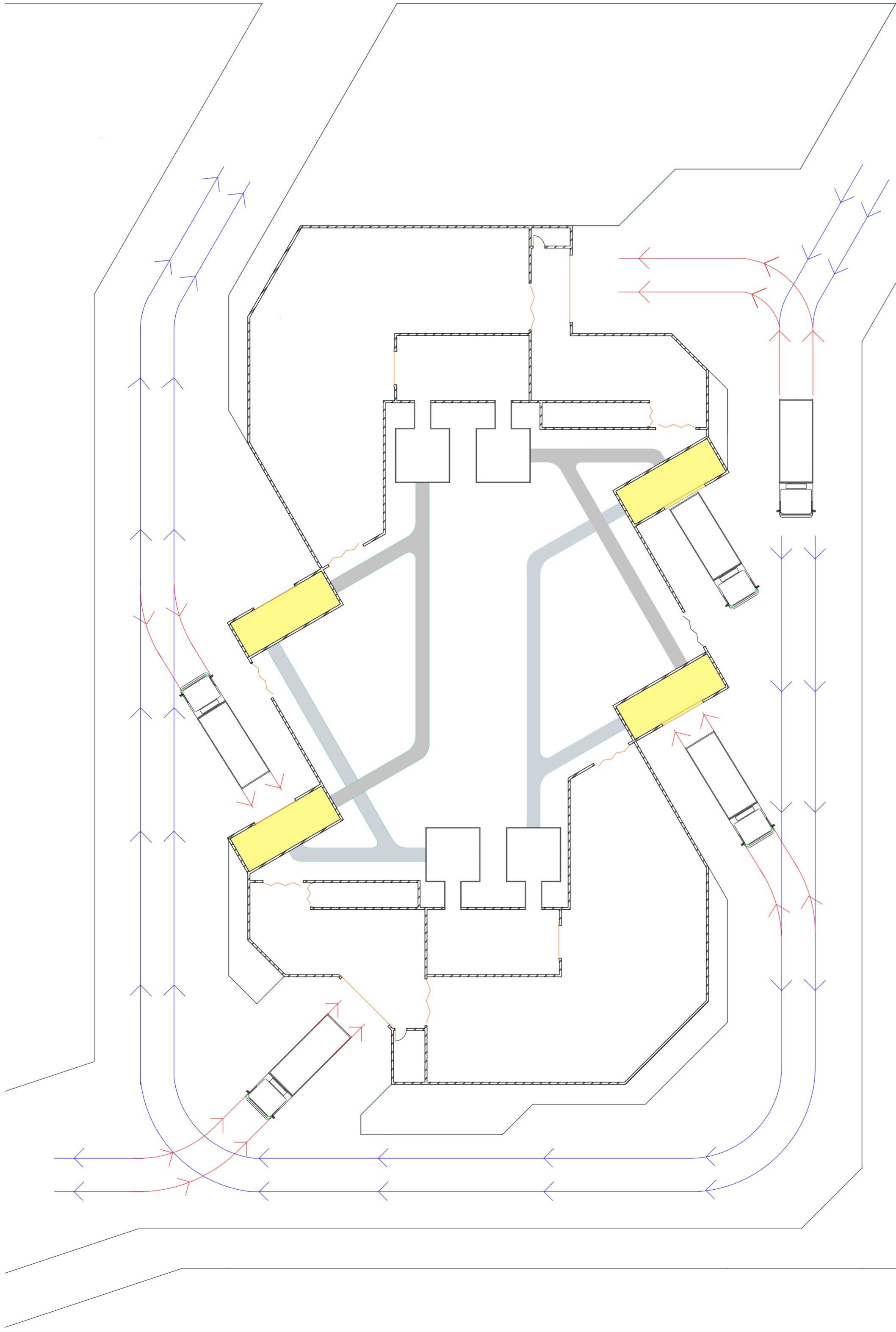

-  PINTU DROP SAMPAH
-  ARAH TRUK MAJU
-  ARAH TRUK MUNDUR

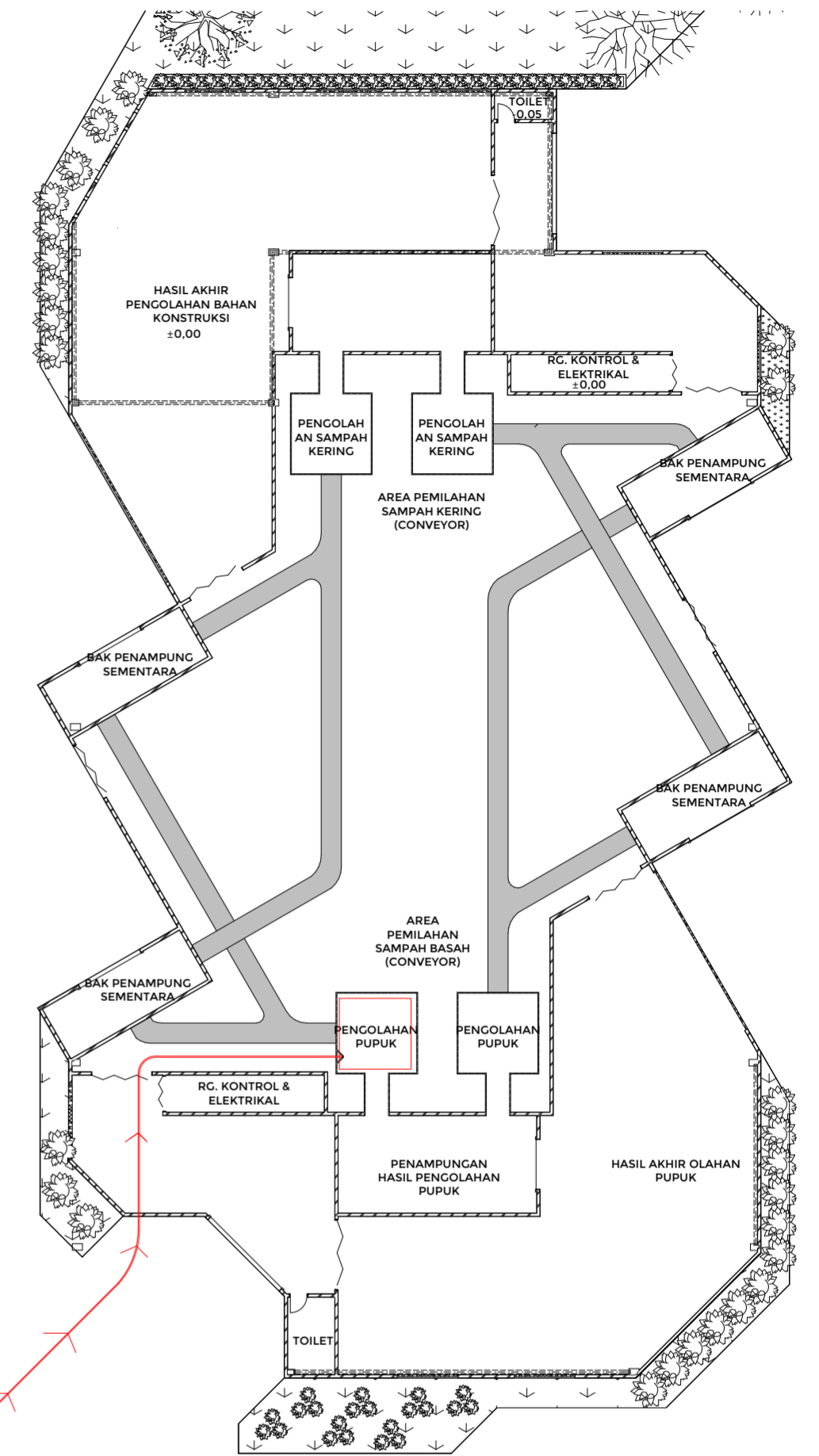
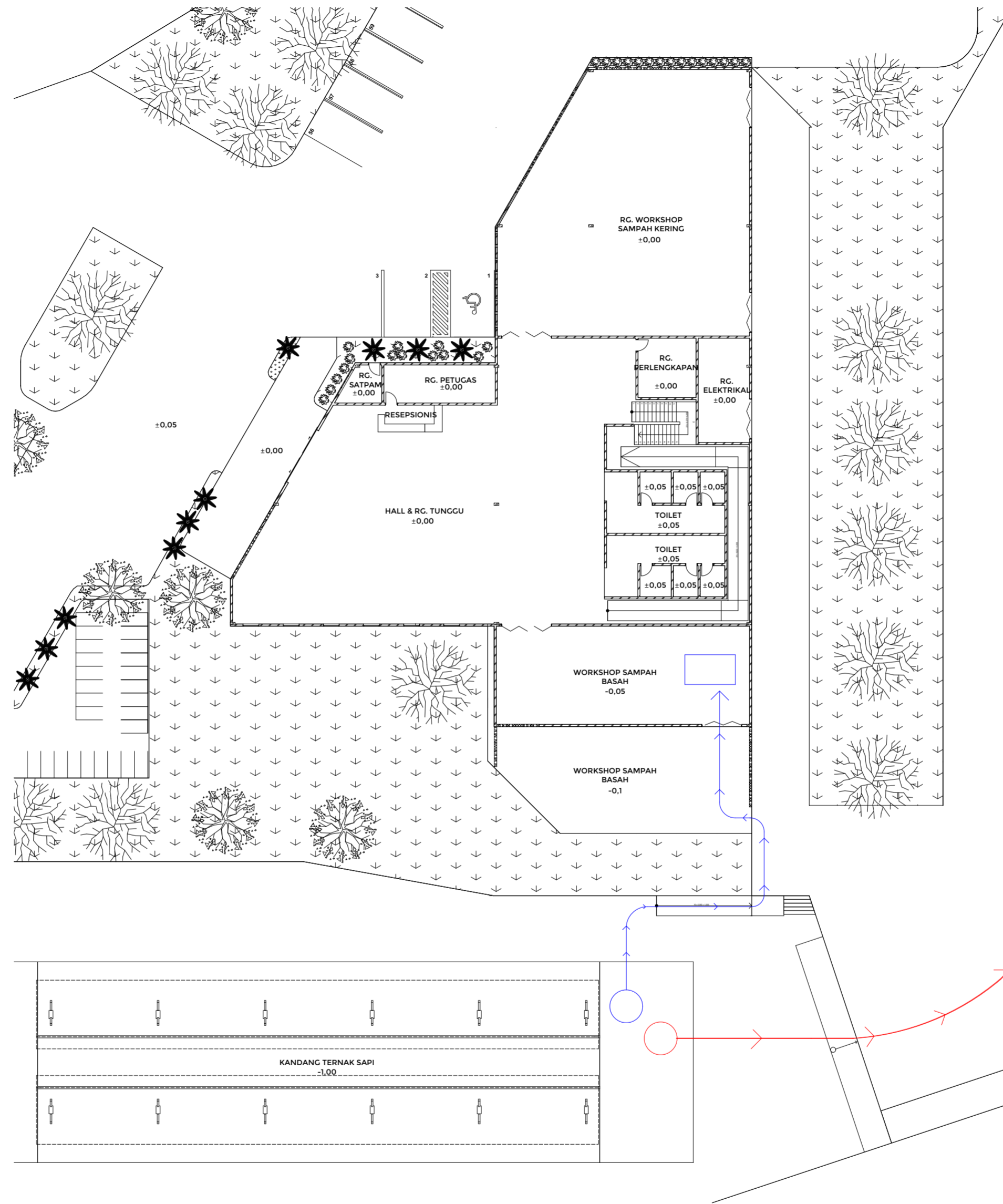
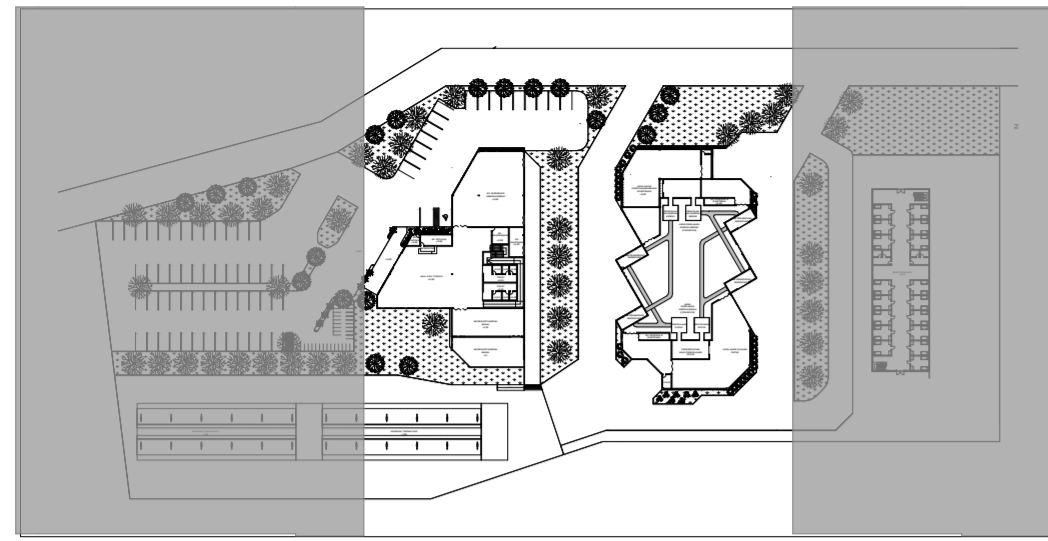

PROJECT	LOCATION	DRAWING NAME	DRAWING BY	DESCRIPTION	NOTES	PAGE	 JURUSAN ARSITEKTUR FAKULTAS TEKNIK SIPIL DAN PERENCANAAN UNIVERSITAS ISLAM INDONESIA
Bachelor Final Project "WASTE LIVING LABORATORY PIYUNGAN"	TPST Piyungan Ngablak, Sitimulyo, Piyungan, Bantul, DIY	Skema distribusi residu ternak sapi , Siteplan	Fairuz Rana Zhavira 14512017				
		SCALE				TOTAL PAGE	

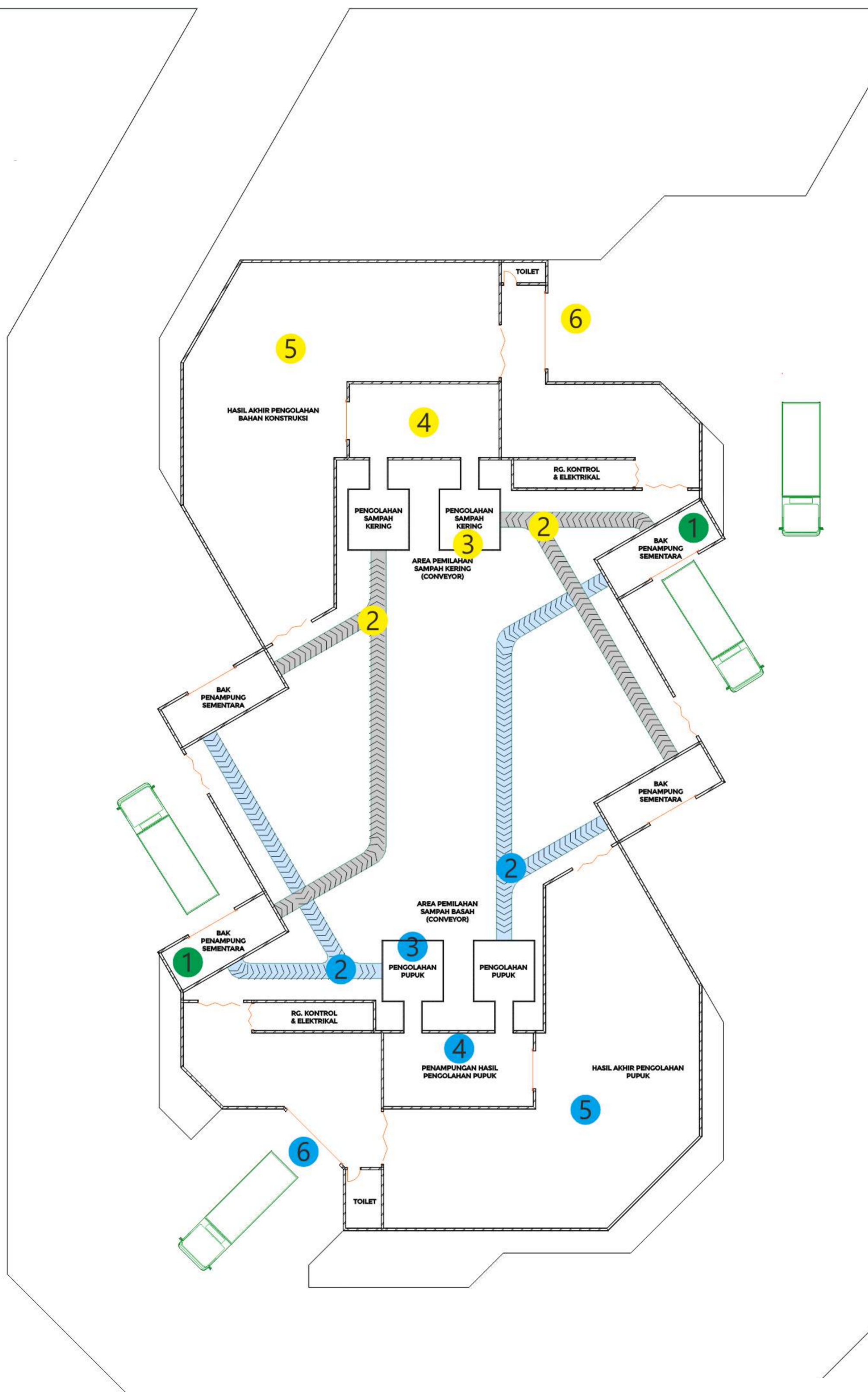

- **Pintu drop sampah**
- **Tahap proses sampah kering**
- **Tahap proses sampah basah**
- Jalur conveyor sampah kering**
- Jalur conveyor sampah basah**
- > **Arah jalur conveyor**

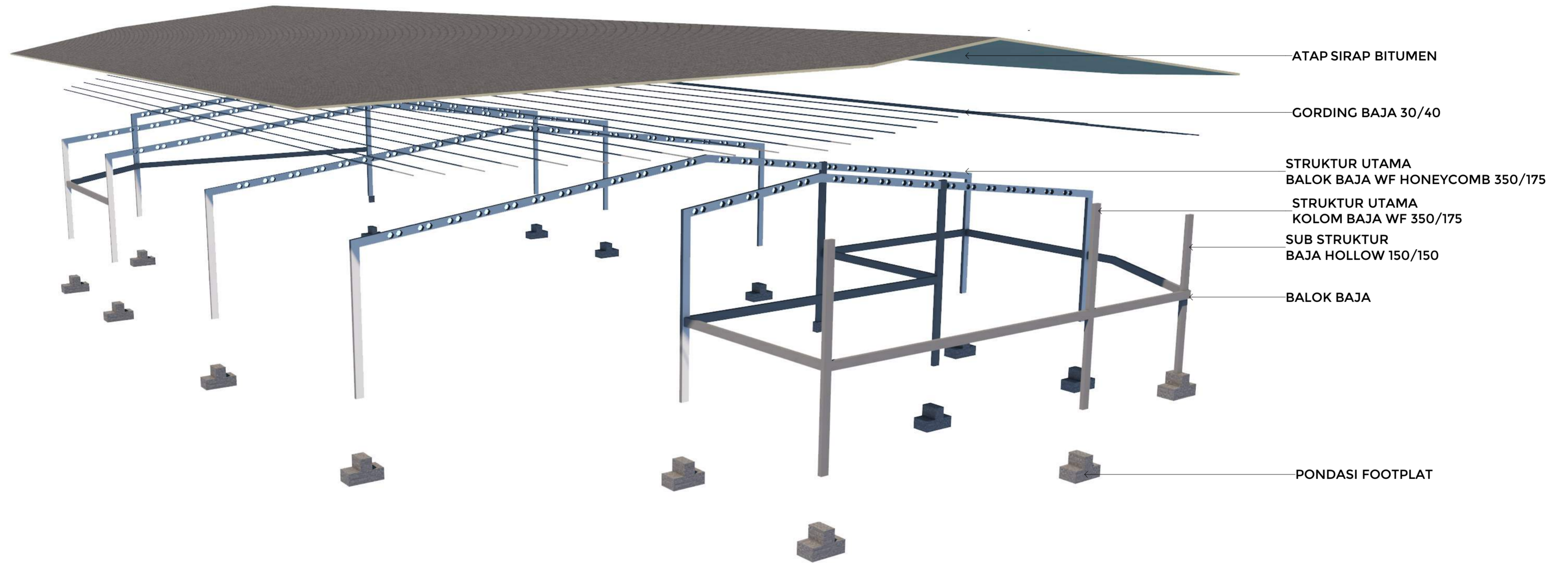

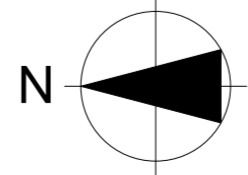
PROJECT	LOCATION	DRAWING NAME	DRAWING BY	DESCRIPTION	NOTES	PAGE	 JURUSAN ARSITEKTUR FAKULTAS TEKNIK SIPIL DAN PERENCANAAN UNIVERSITAS ISLAM INDONESIA
Bachelor Final Project "WASTE LIVING LABORATORY PIYUNGAN"	TPST Piyungan Ngablak, Sitimulyo, Piyungan, Bantul, DIY	SKEMA STRUKTUR BANGUNAN PENGOLAHAN SAMPAH	Fairuz Rana Zhavira 14512017				
		SCALE				TOTAL PAGE	

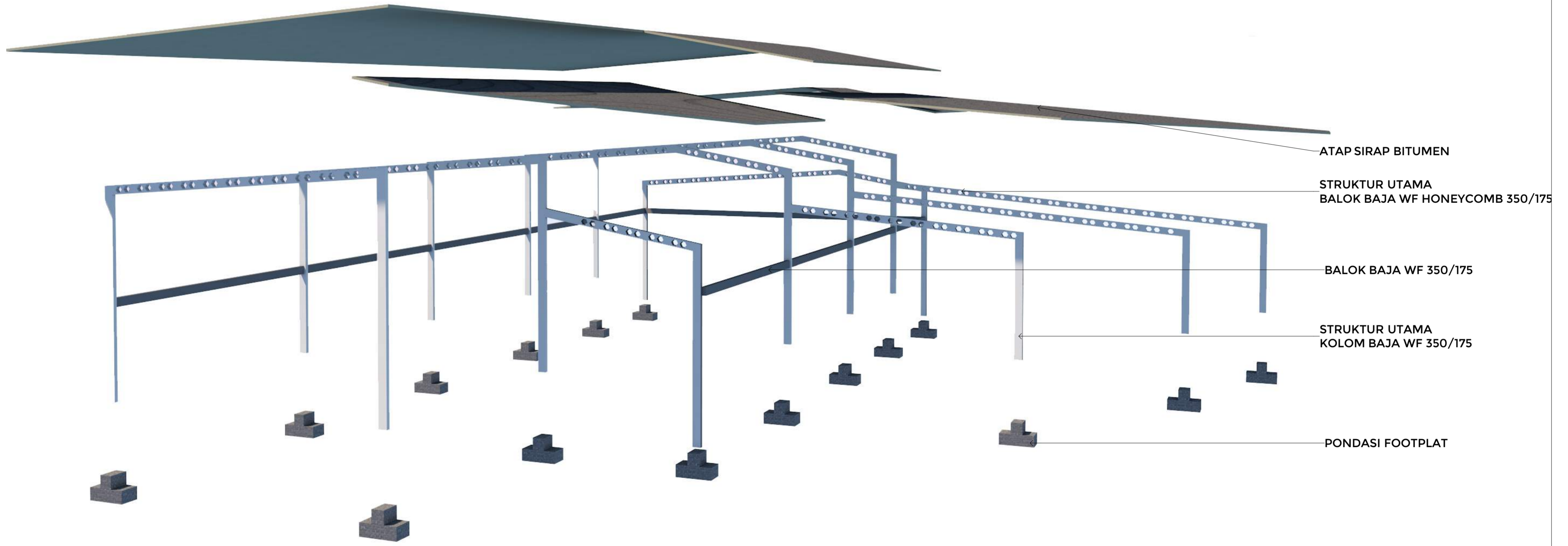

PROJECT	LOCATION	DRAWING NAME	DRAWING BY	DESCRIPTION	NOTES	PAGE
Bachelor Final Project "WASTE LIVING LABORATORY PIYUNGAN"	TPST Piyungan Ngablak, Sitimulyo, Piyungan, Bantul, DIY	SKEMA STRUKTUR BANGUNAN LAB. WORKSHOP	Fairuz Rana Zhavira 14512017			
		SCALE				TOTAL PAGE



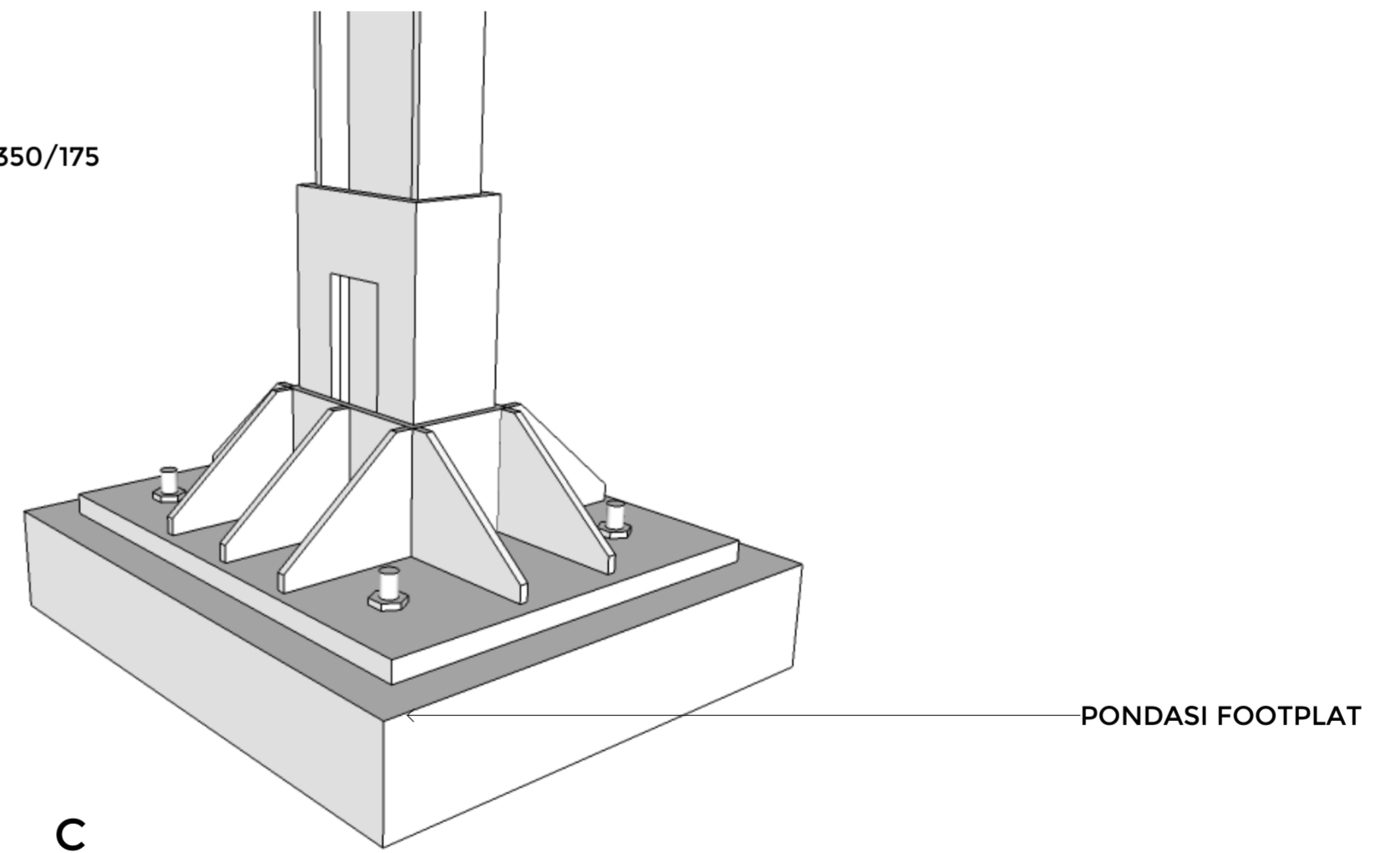
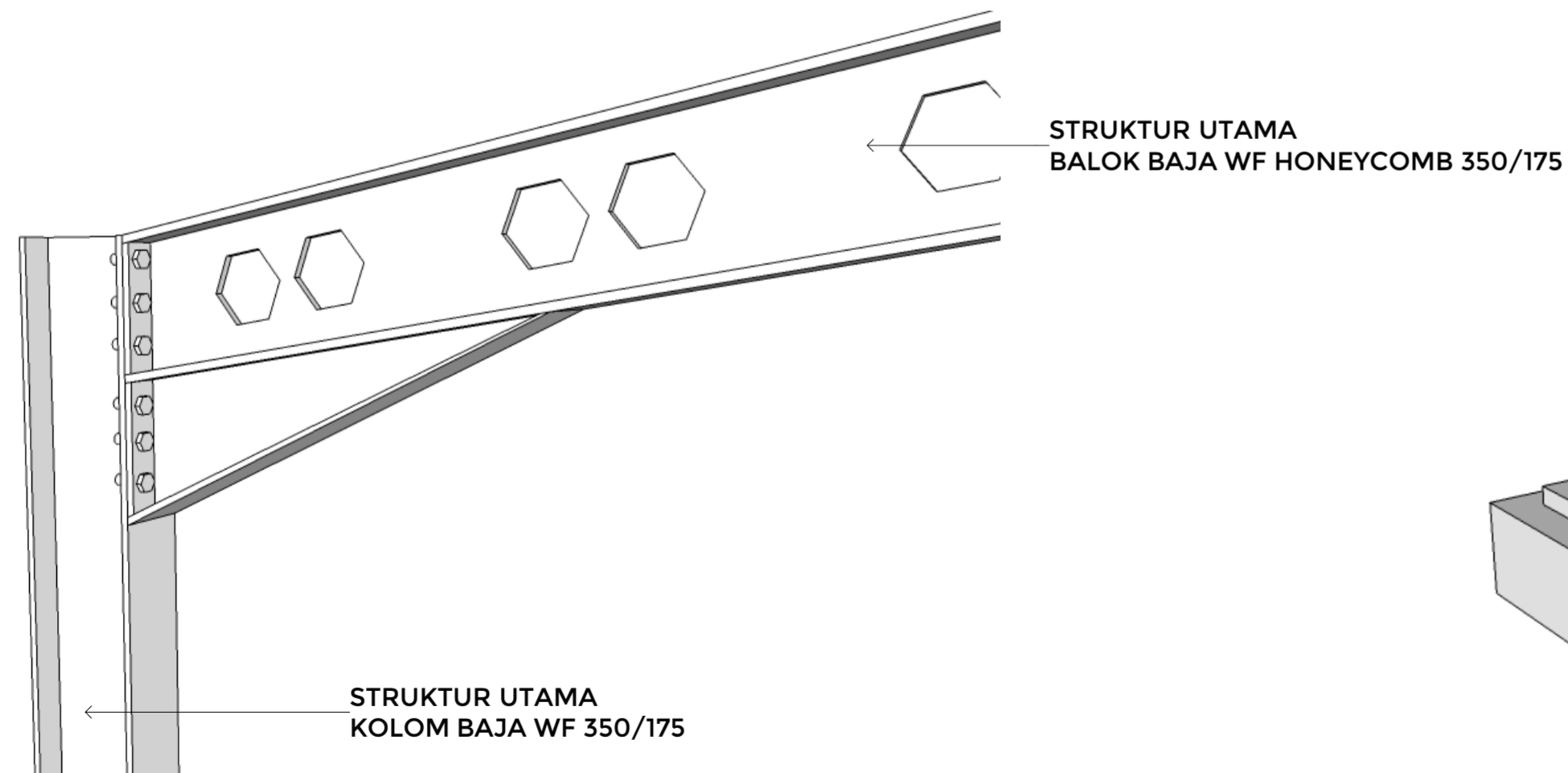
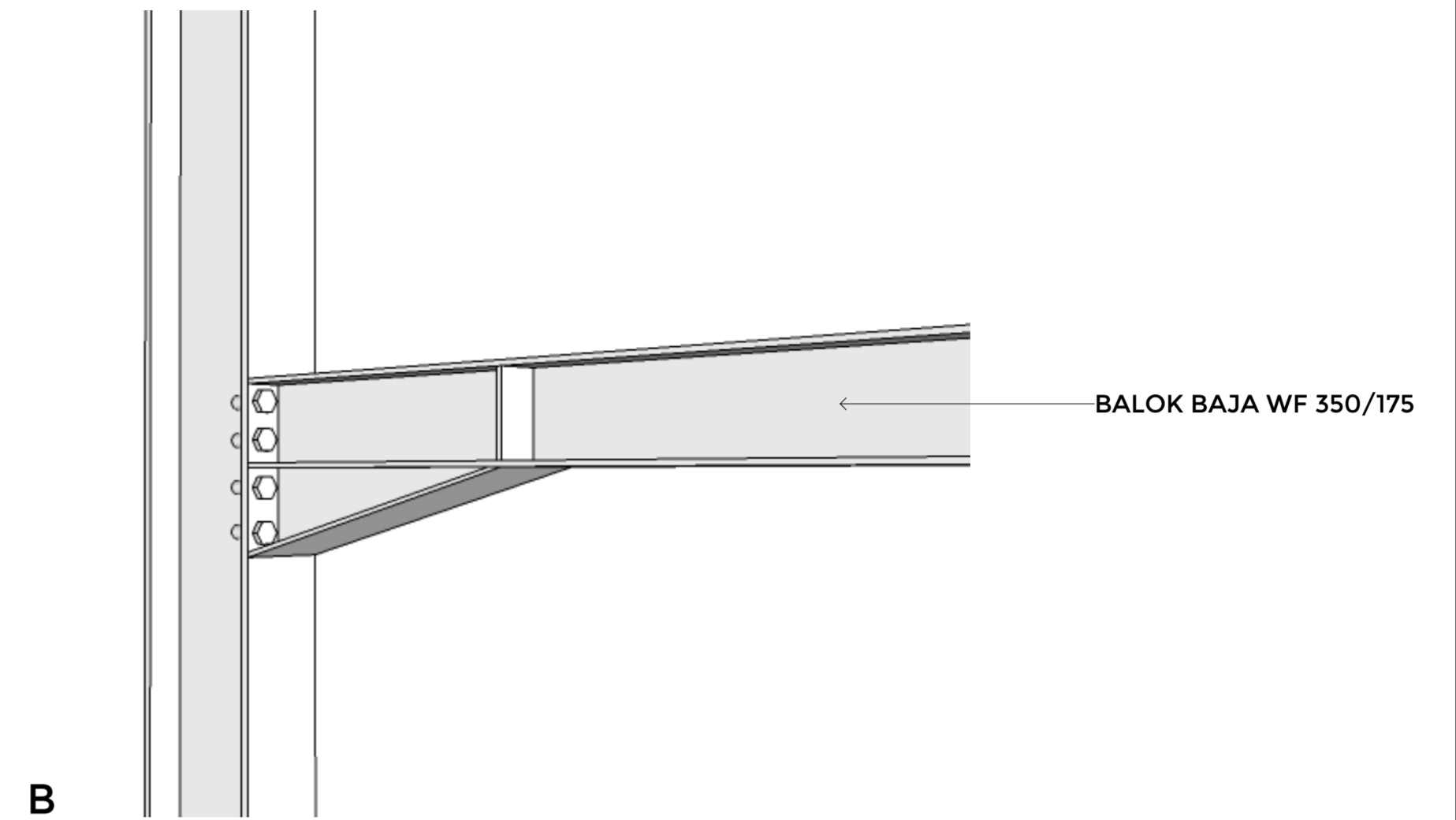
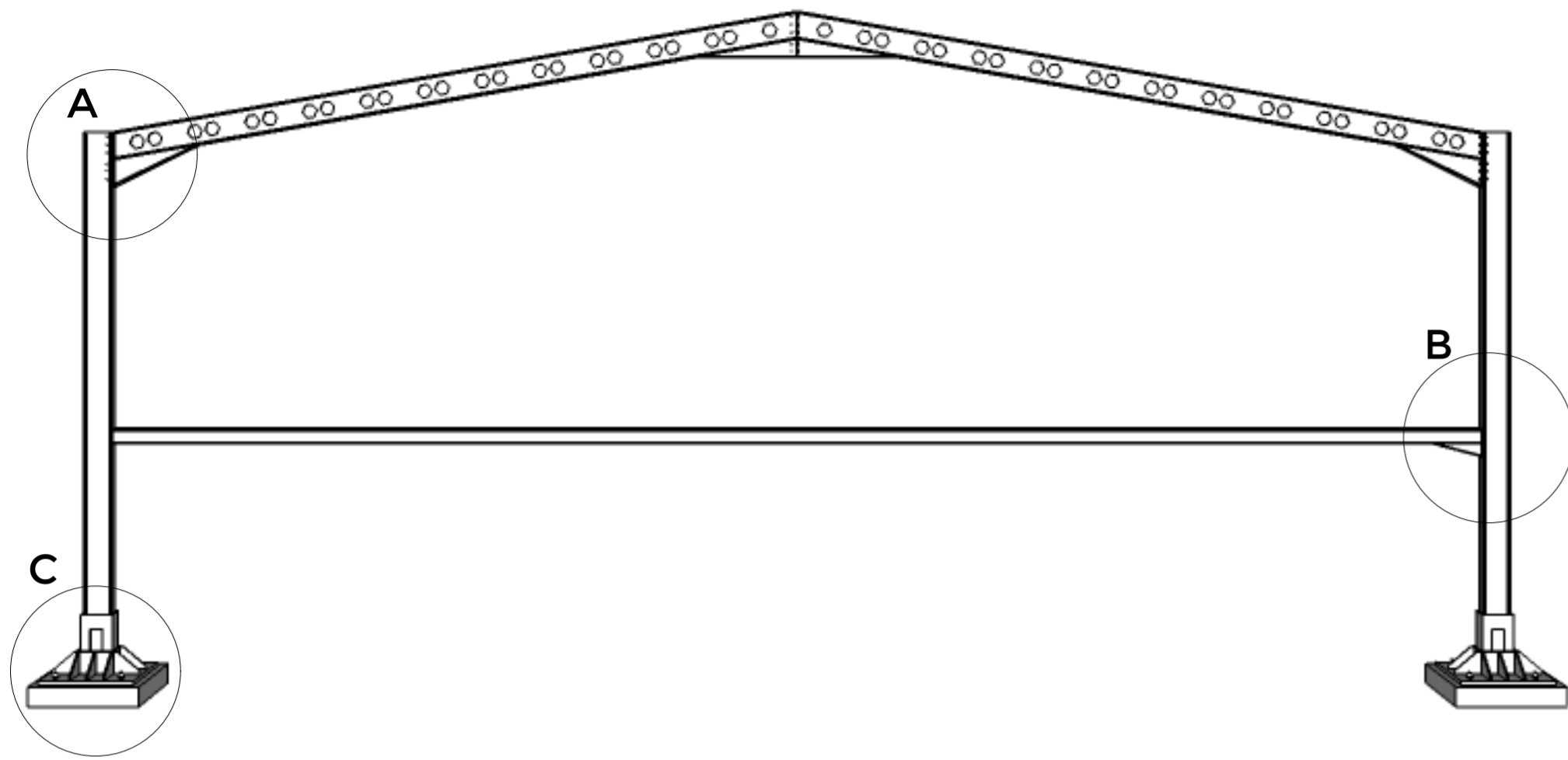

PROJECT	LOCATION	DRAWING NAME	DRAWING BY	DESCRIPTION	NOTES	PAGE
Bachelor Final Project "WASTE LIVING LABORATORY PIYUNGAN"	TPST Piyungan Ngablak, Sitimulyo, Piyungan, Bantul, DIY	SKEMA STRUKTUR	Fairuz Rana Zhavira 14512017			
		SCALE				TOTAL PAGE

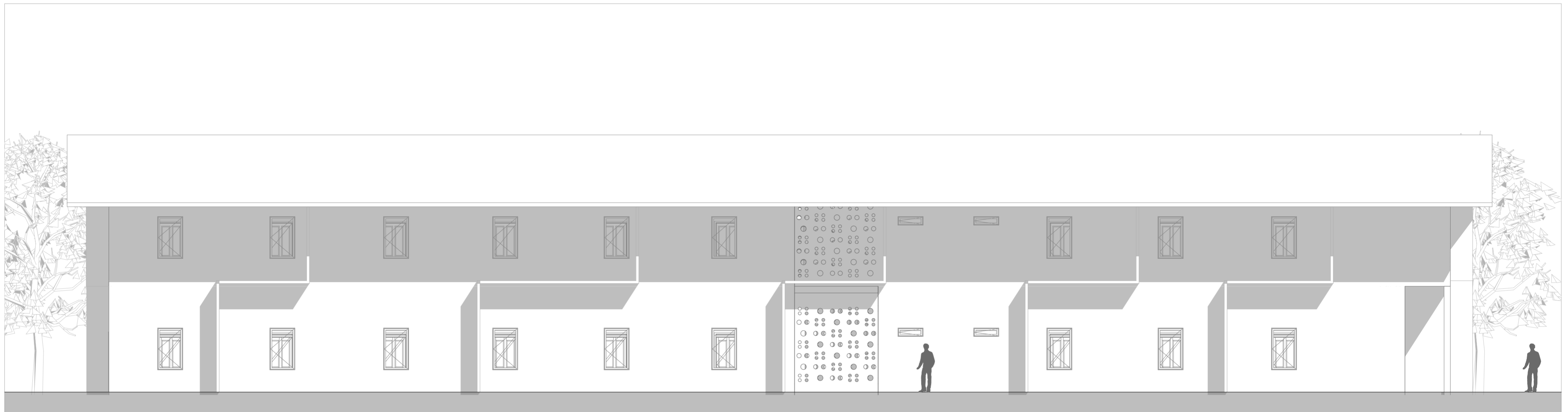

Tampak Selatan Pukul 11.00
1:100

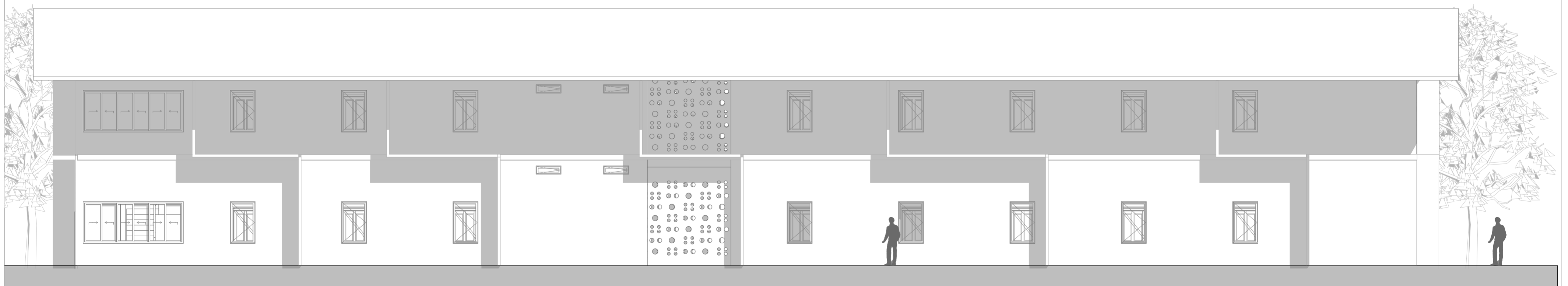

Tampak Utara Pukul 13.00
1:100

PROJECT	LOCATION	DRAWING NAME	DRAWING BY	DESCRIPTION	NOTES	PAGE	 JURUSAN ARSITEKTUR FAKULTAS TEKNIK SIPIL DAN PERENCANAAN UNIVERSITAS ISLAM INDONESIA
Bachelor Final Project "WASTE LIVING LABORATORY PIYUNGAN"	TPST Piyungan Ngablak, Sitimulyo, Piyungan, Bantul, DIY	Tampak Selatan Pukul 11.00, Tampak Utara Pukul 13.00	Fairuz Rana Zhavira 14512017			TOTAL PAGE	
		1:100					

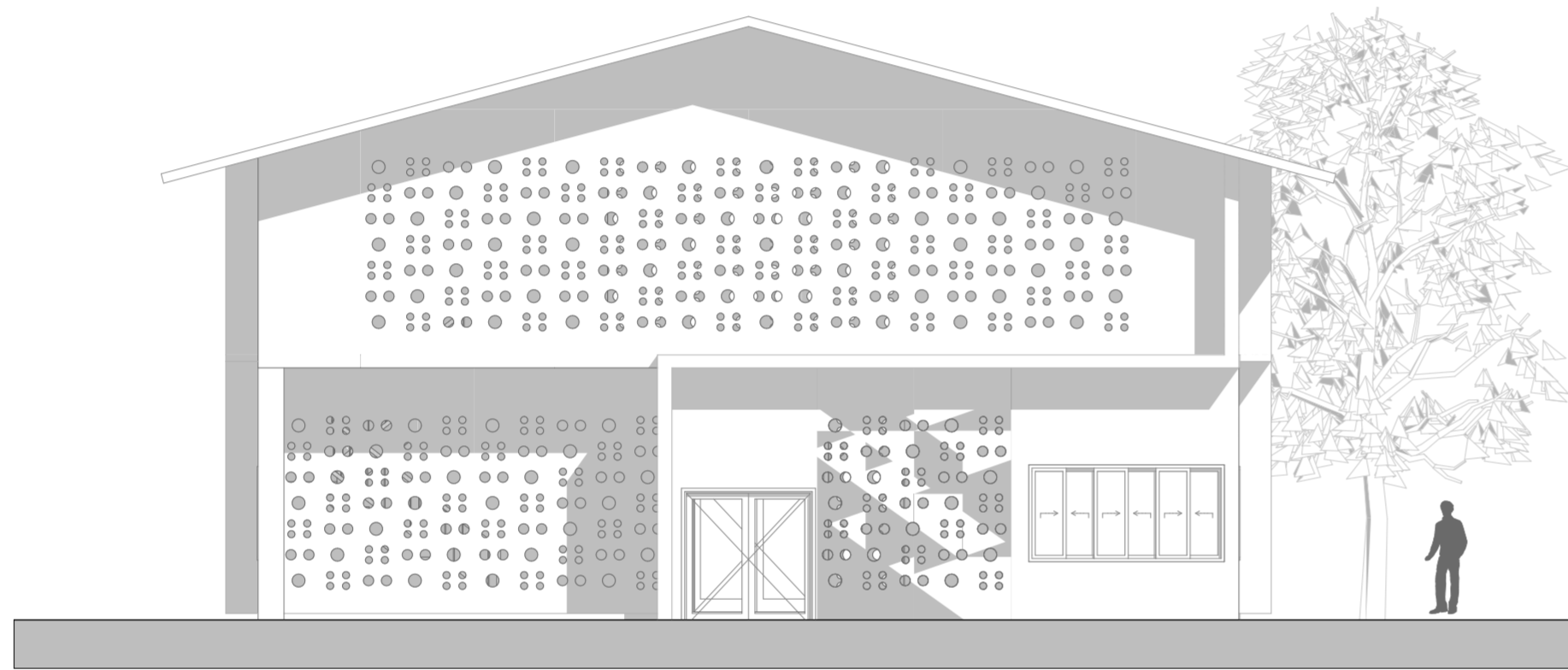

Tampak Barat Pukul 09.00
1:100

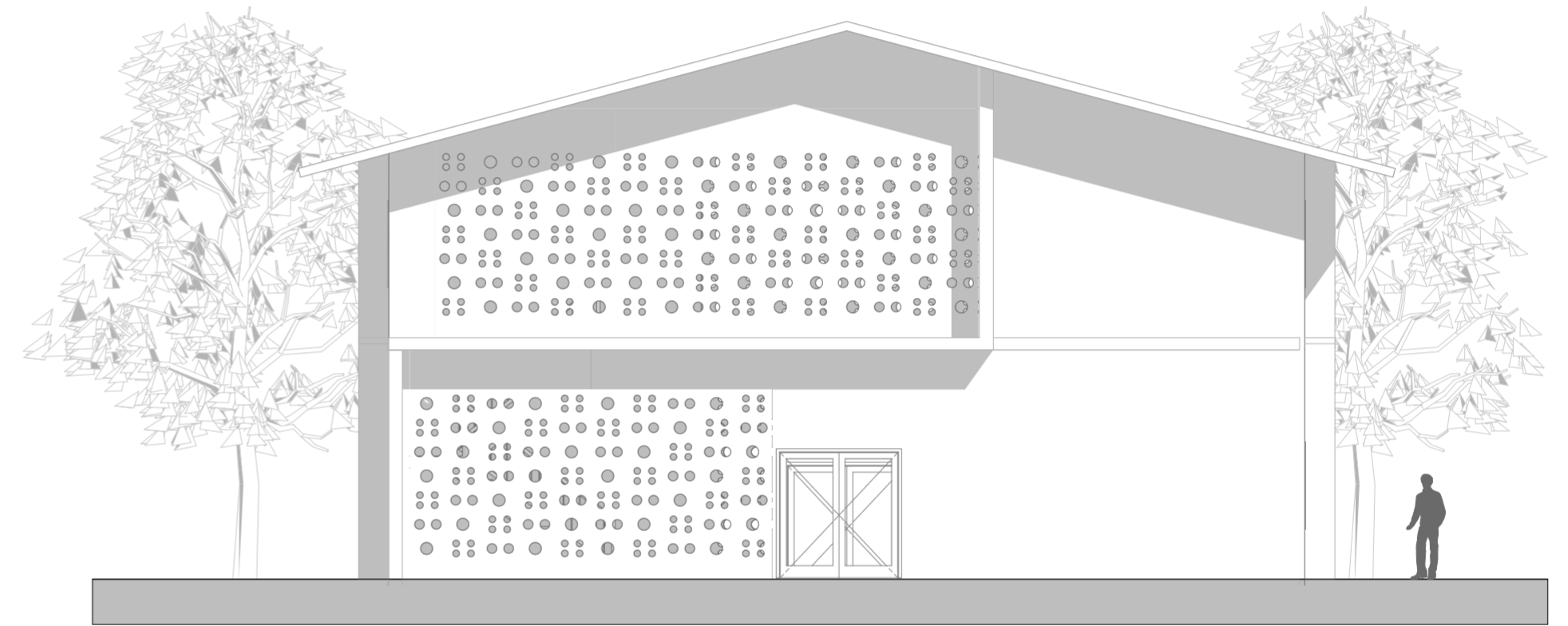

Tampak Timur Pukul 15.00
1:100

PROJECT	LOCATION	DRAWING NAME	DRAWING BY	DESCRIPTION	NOTES	PAGE	 JURUSAN ARSITEKTUR FAKULTAS TEKNIK SIPIL DAN PERENCANAAN UNIVERSITAS ISLAM INDONESIA
Bachelor Final Project "WASTE LIVING LABORATORY PIYUNGAN"	TPST Piyungan Ngablak, Sitimulyo, Piyungan, Bantul, DIY	Tampak Barat Pukul 09.00, Tampak Timur Pukul 15.00	Fairuz Rana Zhavira 14512017			TOTAL PAGE	
		SCALE					
		1:100					