

LAMPIRAN

Lampiran 1 Gambar Denah Balok

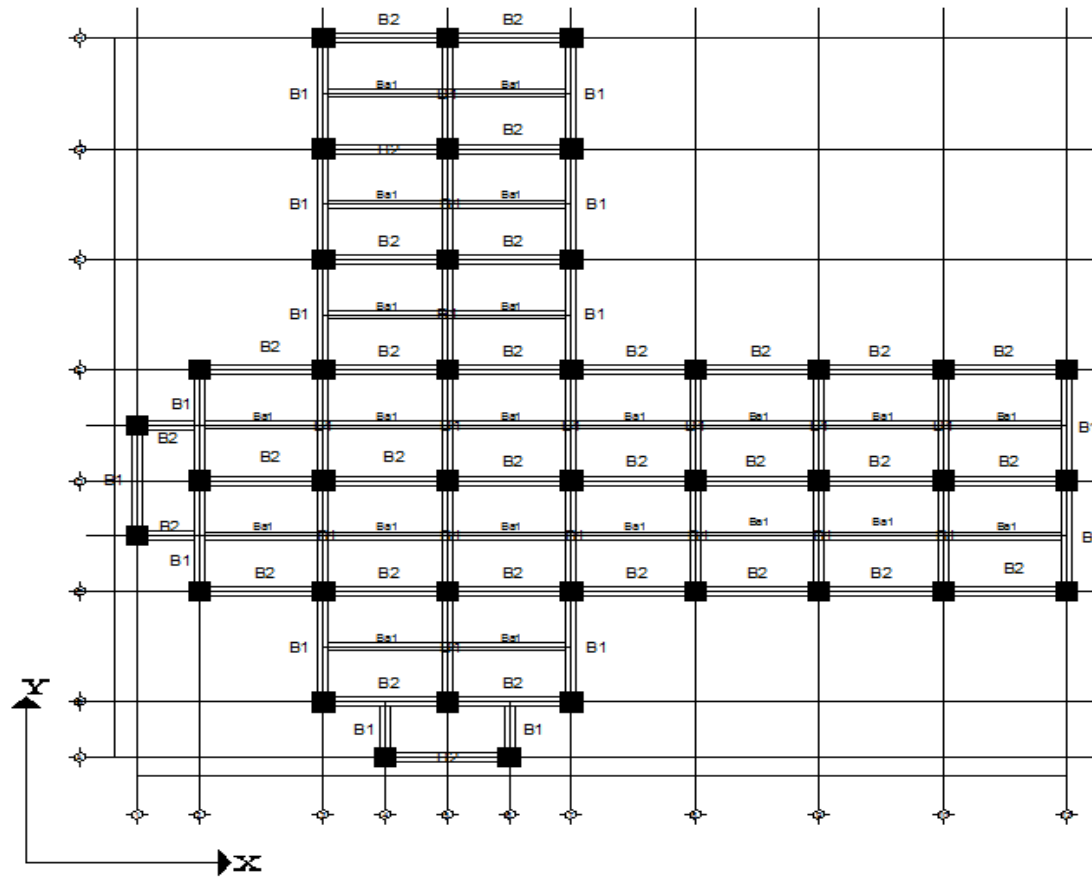

Gambar L-1.1 Denah Balok Model 1

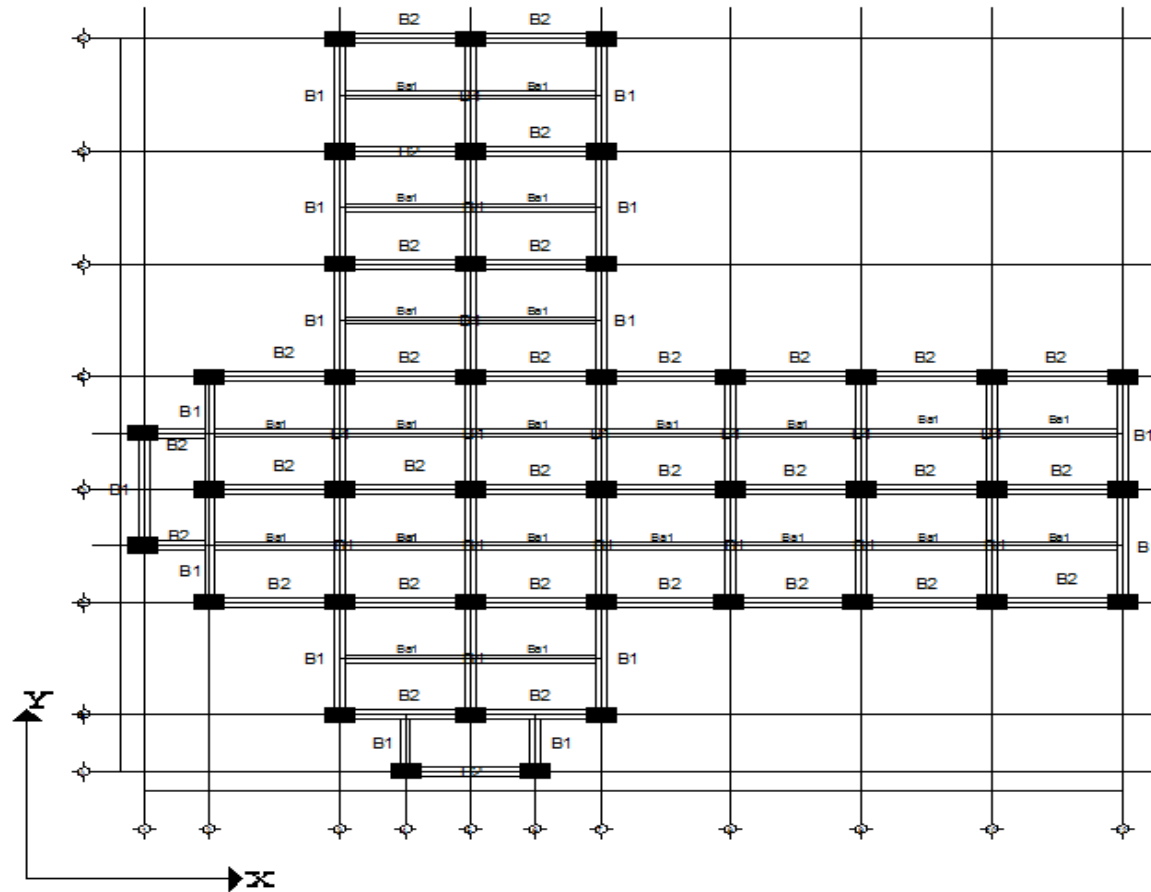

Gambar L-1.2 Denah Balok Model 2

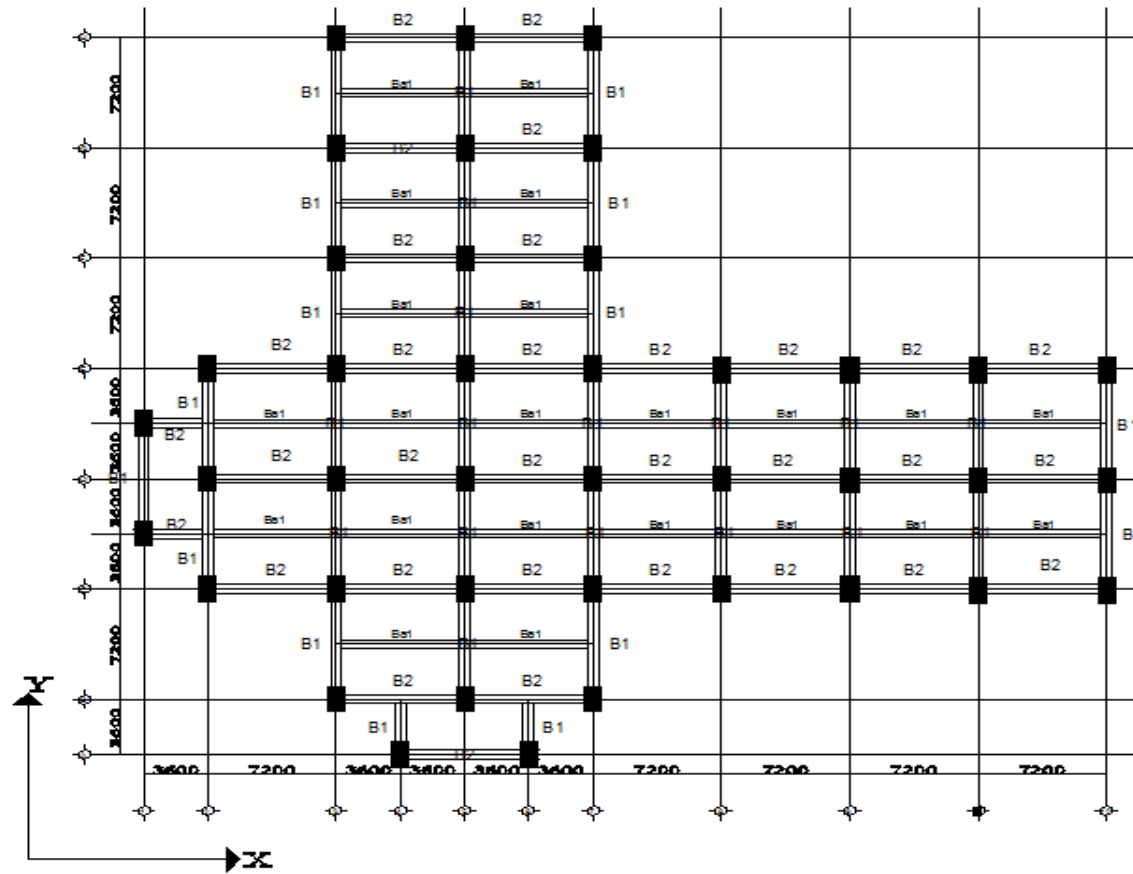

Gambar L-1.3 Denah Balok Model 3

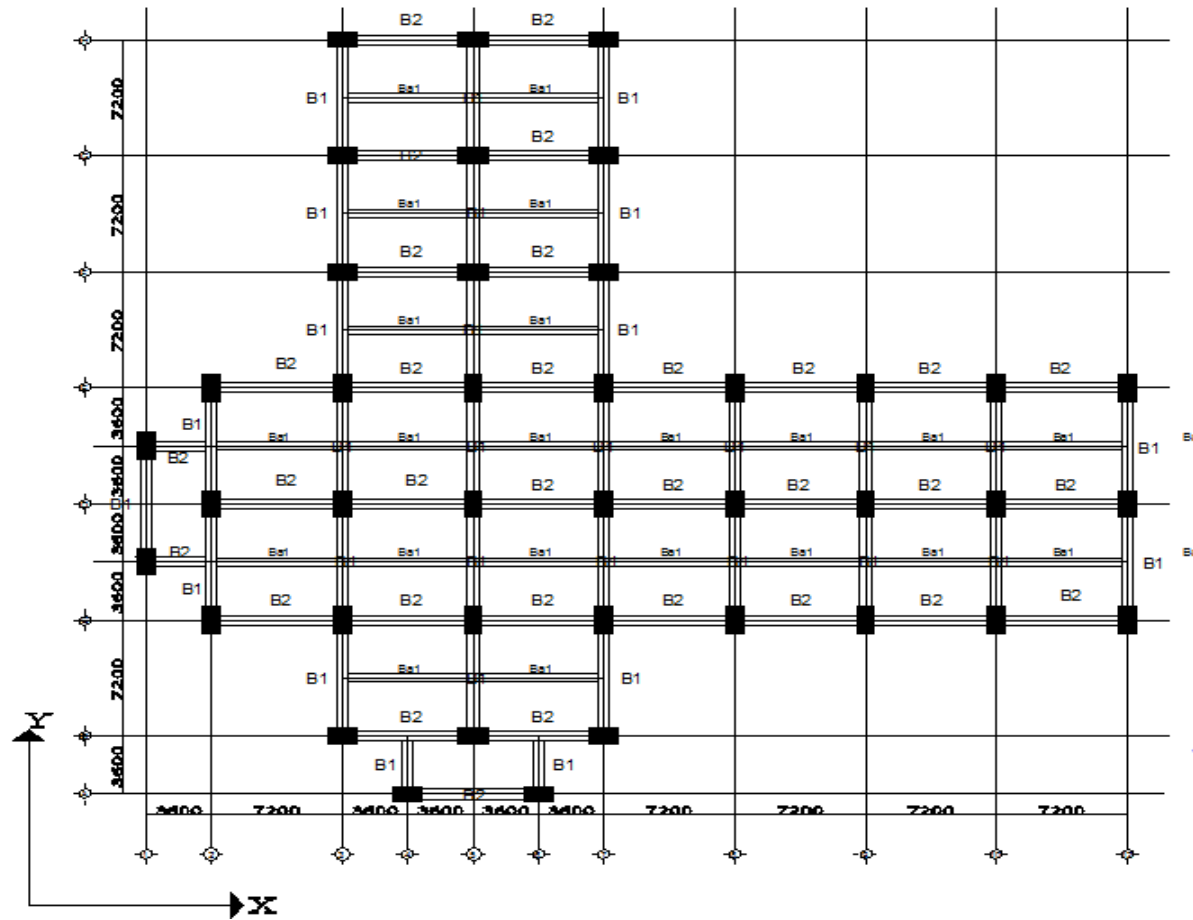

Gambar L-1.4 Denah Balok Model 4

Lampiran 2 Gambar Penulangan Balok



Gambar L-2.1 Penulangan Balok B1 Model 1 Lt. 1-6

Gambar L-2.2 Penulangan Balok B1 Model 1 Lt. 7-9



Gambar L-2.3 Penulangan Balok B1 Model 2 Lt. 1-6

Gambar L-2.4 Penulangan Balok B1 Model 2 Lt. 7-9

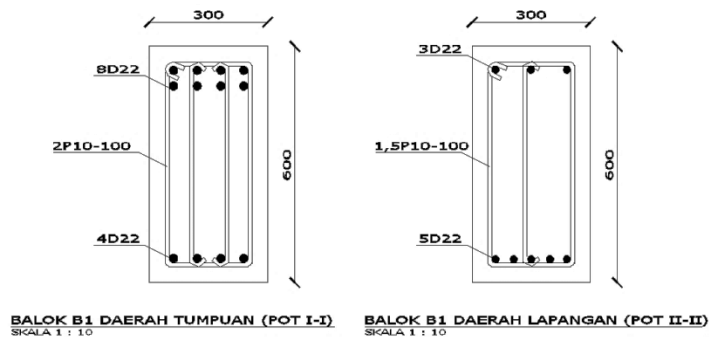

Gambar L-2.5 Penulangan Balok B1 Model 3 Lt. 1-6

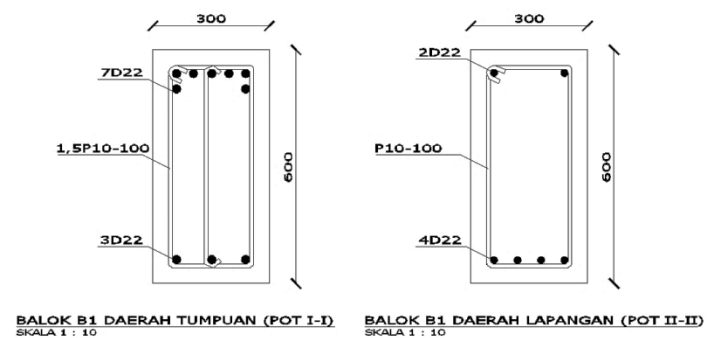

Gambar L-2.6 Penulangan Balok B1 Model 3 Lt. 7-9

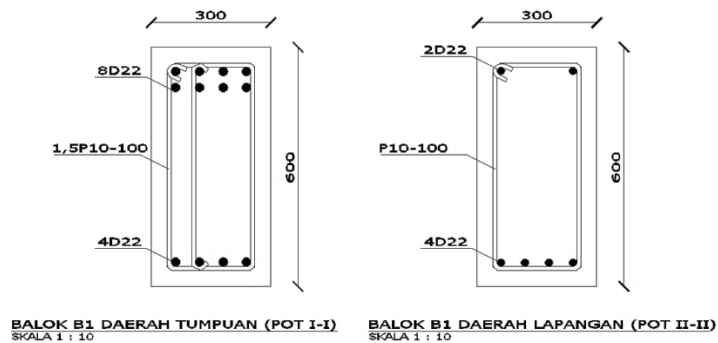

Gambar L-2.7 Penulangan Balok B1 Model 4 Lt. 1-6

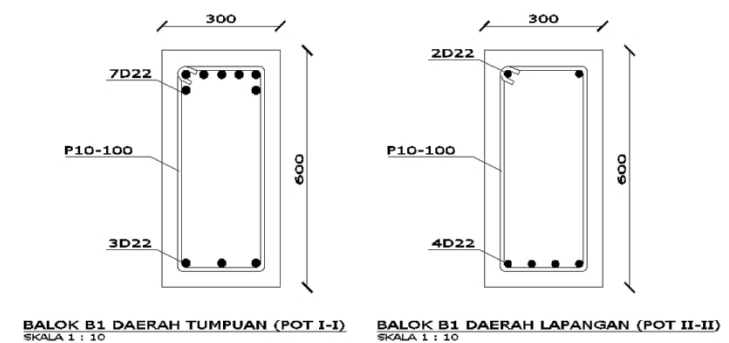

Gambar L-2.8 Penulangan Balok B1 Model 4 Lt. 7-9

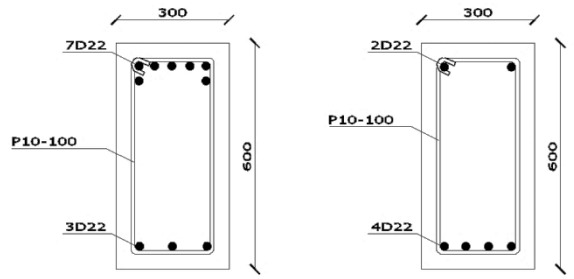

BALOK B2 DAERAH TUMPUAN (POT I-I)
SKALA 1 : 10

BALOK B2 DAERAH LAPANGAN (POT II-II)
SKALA 1 : 10

Gambar L-2.8 Penulangan Balok B2 Semua Model

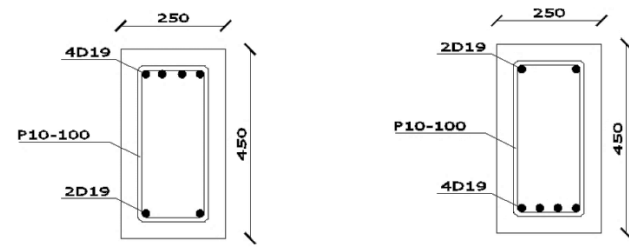

BALOK Ba1 DAERAH TUMPUAN (POT I-I)
SKALA 1 : 10

BALOK Ba1 DAERAH LAPANGAN (POT II-II)
SKALA 1 : 10

Gambar L-2.9 Penulangan Balok Anak Ba1 Semua Model

Lampiran 3 Gambar Penulangan Kolom

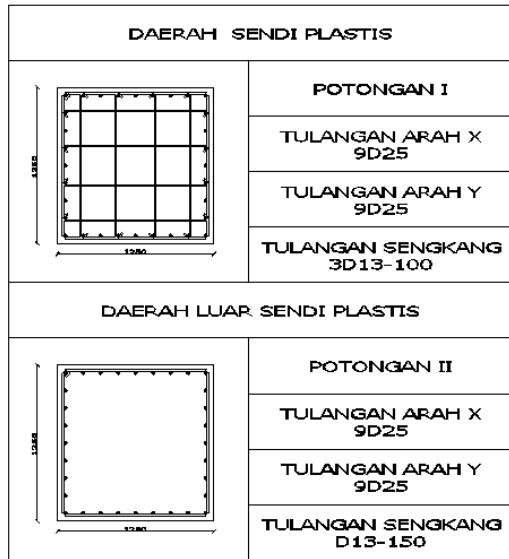

Gambar L-3.1 Model 1

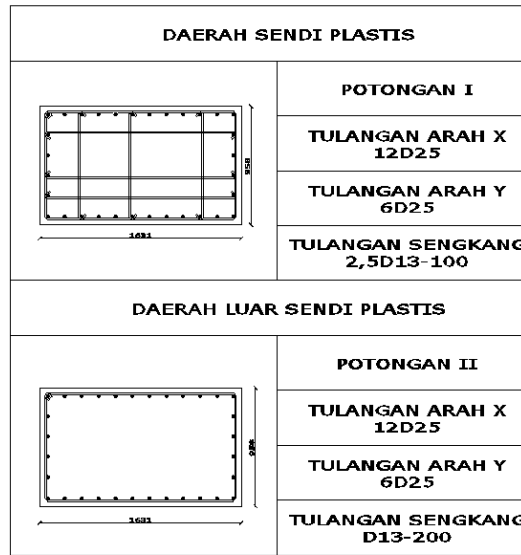

Gambar L-3.2 Model 2

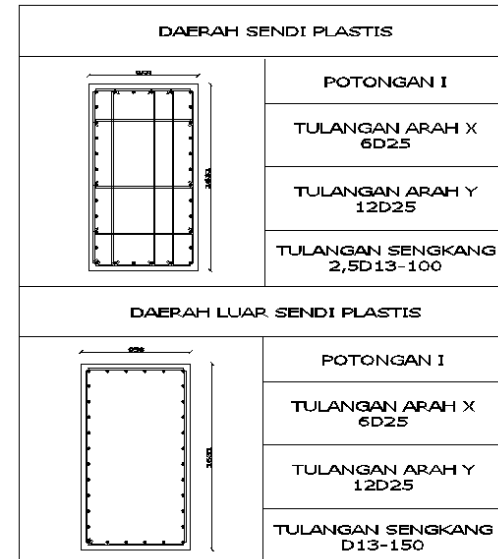

Gambar L-3.3 Model 3

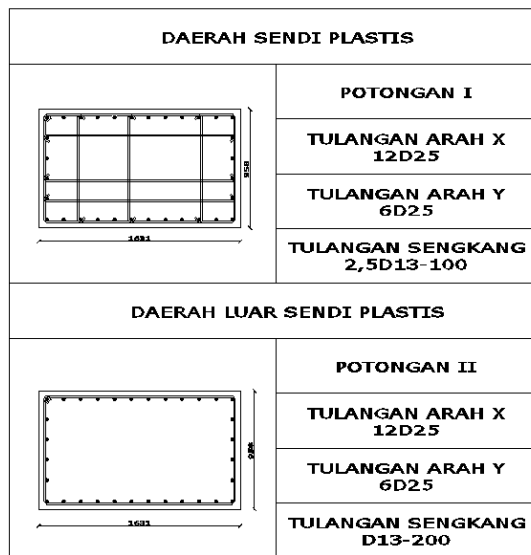

Gambar L-3.4 Model 4 K1

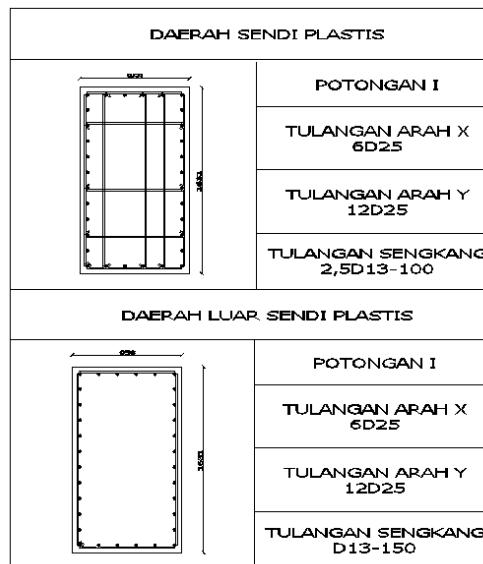

Gambar L-3.5 Model 4 K2