

TUGAS AKHIR

PERPUSTAKAAN FTSP UII	
HADIAH/BELEI	
TGL. TERIMA :	A - 12 - 2007
NO. JUDUL :	2672
NO. INV. :	5120002672001
NO. INDUK :	002672

**ANALISIS PENGARUH PENCAMPURAN BAHAN ADITIF
KAPUR KARBID PADA TANAH BERBUTIR HALUS DI
BAWAH DASAR PONDASI BANGUNAN TERHADAP
DIMENSI PONDASI DENGAN METODE VESIC**

Diajukan kepada Universitas Islam Indonesia Yogyakarta Untuk Memenuhi
Persyaratan Memperoleh Derajat Sarjana Strata Satu (S1) Teknik Sipil

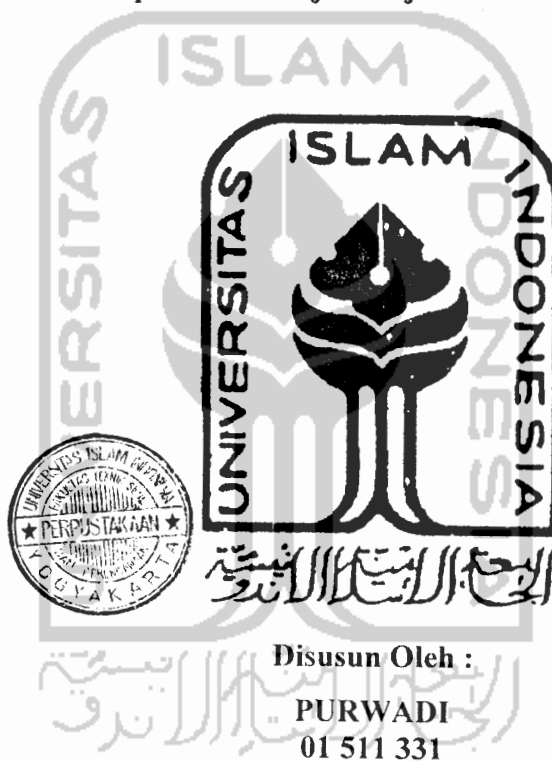

**JURUSAN TEKNIK SIPIL
FAKULTAS TEKNIK SIPIL DAN PERENCANAAN
UNIVERSITAS ISLAM INDONESIA
YOGYAKARTA**

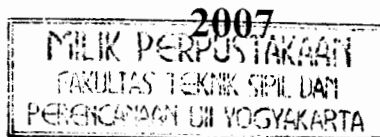

LEMBAR PENGESAHAN

ANALISIS PENGARUH PENCAAMPURAN BAHAN ADITIF KAPUR KARBID PADA TANAH BERBUTIR HALUS DI BAWAH DASAR PONDASI BANGUNAN TERHADAP DIMENSI PONDASI DENGAN METODE VESIC

Diajukan kepada Universitas Islam Indonesia Yogyakarta Untuk Memenuhi
Persyaratan Memperoleh Derajat Sarjana Strata Satu (S1) Teknik Sipil

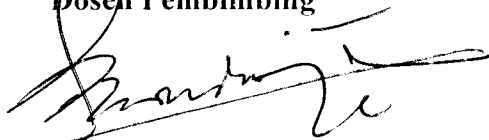

Disetujui :
Dosen Pembimbing

Ir. H. Ibnu Sudarmadji, MS

Tanggal : 07/10/07
5

KATA PENGANTAR



الْحَمْدُ لِلَّهِ رَبِّ الْعَالَمِينَ

Puji syukur penulis panjatkan kehadirat Allah SWT yang telah melimpahkan Berkah dan Inayah-Nya sehingga pada saat ini penulis dapat menyelesaikan penulisan Tugas Akhir ini. Sholawat dan salam semoga senantiasa ditetapkan atas Nabi Muhammad SAW, keluarganya, para sahabat dan seluruh pengikut setianya sampai akhir zaman. Adapun penulisan Tugas Akhir ini dilaksanakan sebagai persyaratan untuk menyelesaikan jenjang strata satu (S1) di Fakultas Teknik Sipil dan Perencanaan Universitas Islam Indonesia Yogyakarta.

Dalam Tugas Akhir ini yang berjudul "**Analisis Pengaruh Pencampuran Bahan Aditif Kapur Karbid Pada Tanah Berbutir Halus Di Bawah Dasar Pondasi Bangunan Terhadap Dimensi Pondasi Dengan Metode Vesic**", telah di usahakan dengan segenap kemampuan dan pengetahuan yang dimiliki, berdasarkan pada buku-buku referensi dan pedoman yang ada. Mengingat keterbatasan yang ada, disadari bahwa Tugas Akhir ini masih jauh dari sempurna sehingga diperlukan kritik dan saran yang bermanfaat untuk kesempurnaan Tugas Akhir. Dalam penyusunan Tugas Akhir ini telah banyak diperoleh bantuan bimbingan dan petunjuk dari berbagai pihak, baik moral maupun materiil. Untuk itu di ucapkan terima kasih sebanyak-banyaknya kepada :

1. Bapak DR. Ir. H. Ruzardi, MS, selaku Dekan Fakultas Teknik Sipil dan Perencanaan, Universitas Islam Indonesia,
2. Bapak Ir. H. Faisol AM, MS, selaku Ketua Jurusan Teknik Sipil, Fakultas Teknik Sipil dan Perencanaan, Universitas Islam Indonesia,
3. Bapak Ir. H. Ibnu Sudarmadji, MS, selaku Dosen Pembimbing,
4. Bapak DR. Ir. H. Edy Purwanto, CES, DEA, selaku Dosen Penguji,

5. Bapak Ir. Akhmad Marzuko, MT, selaku Dosen Penguji,
6. Pak Sugi dan Pak Yudi, selaku laboran Laboratorium Mekanika Tanah,
7. Semua pihak di lingkungan Jurusan Teknik Sipil yang telah membantu proses penyusunan Tugas Akhir ini,
8. Semua pihak yang telah membantu dalam penyusunan Tugas Akhir ini,
9. Teman-teman takmir Masjid Ulil Albab dan Masjid Darussalam serta semua pihak yang telah banyak memberikan bantuan terselesainya tugas akhir ini.

Akhirnya besar harapan penulis semoga laporan ini dapat bermanfaat bagi penulis secara pribadi dan bagi siapa saja yang membacanya. Penulis menyadari laporan ini jauh dari sempurna, penulis terbuka menerima kritik dan saran.

الشكركم ورحمة الله وبركاته

Jogjakarta, April 2007

Penulis

الجامعة الإسلامية
الابن سينا

HALAMAN PERSEMBAHAN

Tugas akhir ini saya persembahkan untuk...

Ayahanda tercinta Maman Sumantri, Bundaku tercinta Siti Geryati, jazakumullahu khairan katsiran atas pengorbanan yang telah diberikan yang tak ternilai harganya, atas motivasi, nasehat dan do'a. Adik-adikku tercinta dan tersayang Simuel, Bagus, Inok, Lia yang lucu, kalian telah membangkitkan semangatku untuk menjadi contoh sebagai kakak yang baik buat kalian. Juga kepada Ustadz-ustadzku, saudara-saudaraku seperjuangan di Masjid Darussalam GPW (Taufiq, Bang Udin, Anang, Cecep, Ivan sayang, Rizal, Elvan) serta saudaraku yang berada di Keluarga Besar Takmir Masjid Ulil Albab, Asrama Takmir Putra Al Zain, Asrama Takmir Putri Al Mahfudz Universitas Islam Indonesia Yogyakarta, Asrama Al Kahfi Mbonjotan dan semua orang yang telah banyak memberikan semangat dan motivasi hingga Tugas Akhir ini bisa terselesaikan dengan baik.

ABSTRAK

Bangunan Sipil dapat dibagi menjadi dua bagian, yaitu bagian diatas tanah (Upperstructure) dan bagian dibawah tanah (Substructure). Bagian Upperstructure adalah seluruh bagian struktur dari bangunan yang ada diatas permukaan tanah. Bagian Substructure, yaitu segala bagian bangunan yang ada didalam atau dibawah tanah, yakni pondasi tempat seluruh bangunan itu bertumpu. Dua kriteria yang harus dipenuhi oleh pondasi yang baik adalah daya dukung yang cukup dan penurunan tanah (settlement) yang tidak membahayakan bangunan. Oleh karena itu diperlukan pengenalan dan penguasaan dari sifat laku (behavior) dari tanah.

Tanah harus memenuhi persyaratan kualitas baik secara fisik maupun teknis. Namun tidak semua tanah dalam keadaan aslinya memenuhi persyaratan kualitas yang diinginkan. Sifat tanah lempung dan lanau yang kurang baik dengan kekuatannya yang rendah dan pengembangan yang cukup besar, maka diperlukan usaha perbaikan sifat-sifat fisik dan sifat-sifat mekanis tanah untuk mencapai persyaratan teknis tertentu. Cara ini dikenal dengan Stabilisasi Tanah, yakni dengan menambahkan bahan aditif Kapur karbid pada tanah berbutir halus sehingga tanah memenuhi persyaratan sebagai pendukung konstruksi bangunan. Tujuan dari penelitian ini adalah mencari klasifikasi jenis tanah Pekalongan, mengetahui pengaruh penambahan kapur karbid terhadap kuat geser tanah dan mencari prosentase maksimum penambahan kapur karbid. Variasi kadar Kapur Karbid 1.5% - 10% yang kemudian digunakan untuk menganalisis daya dukung tanah dengan menggunakan teori Vesic.

Hasil dari penelitian menunjukkan bahwa tanah Pekalongan termasuk dalam kelompok OL dengan nama lanau organik dan lempung berlanau organik dengan plastisitas sedang berdasarkan sistem Klasifikasi Tanah Unified. Sedangkan menurut sistem klasifikasi USCS tanah Pekalongan digolongkan dalam lempung kelanauan. Berdasarkan data yang diperoleh, pengaruh penambahan kapur karbid terhadap tanah berbutir halus asal Pekalongan, Jawa Tengah menyebabkan meningkatnya nilai kohesi dan sudut geser dalam tanah. Untuk Uji Triaksial UU hasil prosentase optimum pada variasi 1.5% dan lama pemeraman 14 hari didapat nilai $c = 0.64 \text{ kg/cm}^2$ dan $\phi = 39,72^\circ$ sedangkan untuk Uji Tekan Bebas penambahan kapur karbid sebesar 4.5% dan lama pemeraman 14 hari nilai $c = 1.101 \text{ kg/cm}^2$ dan $\phi = 39^\circ$. Analisis daya dukung tanah menunjukkan bahwa variasi kapur karbid 4.5% dengan pemeraman 14 hari memberikan nilai kuat dukung tanah maksimum sebesar 2154.816 t/m^2 dari tanah asli sebesar 59.1741 t/m^2 . Terjadi kesamaan ukuran pondasi untuk variasi 3% - 10% karena memiliki ukuran pondasi dibawah 1 meter, sehingga diambil minimum 1 meter. Penghematan dimensi pondasi sebesar 75%.

Kata kunci : Stabilisasi Tanah, Kapur Karbid, Tanah Berbutir Halus, Kuat Dukung Tanah, Pondasi.

DAFTAR ISI

HALAMAN JUDUL	i
HALAMAN PENGESAHAN	ii
HALAMAN PERSEMBAHAN	iii
KATA PENGANTAR	iv
ABSTRAK	vi
DAFTAR ISI	vii
DAFTAR NOTASI	x
DAFTAR TABEL	xii
DAFTAR GAMBAR	xiii
DAFTAR LAMPIRAN	xv
BAB I PENDAHULUAN	1
1.1 Latar Belakang.....	1
1.2 Rumusan Masalah.....	3
1.3 Tujuan Penelitian.....	3
1.4 Batasan Masalah.....	3
1.5 Manfaat Penelitian.....	4
BAB II TINJAUAN PUSTAKA	5
1 Penelitian Faratodi Syailendra dan M. Faisal	5
2 Penelitian Ade Rahardian	6
BAB III LANDASAN TEORI	8
3.1 Tanah	8
3.1.1 Umum	8
3.1.2 Klasifikasi Tanah.....	9
a) Sistem Klasifikasi AASHTO	10
b) Klasifikasi Tanah Sistem Unified	12

3.1.3 Sifat - Sifat Tanah.....	13
a) Sifat Fisik Tanah.....	13
1. Uji Hidrometer.....	13
2. Analisis Distribusi Butiran.....	13
b) Sifat Mekanis Tanah.....	14
1. Indeks Properties Tanah.....	14
2. Batas – Batas konsistensi Tanah.....	15
3. Uji Proktor Standar.....	17
4. Uji Tekan Bebas (Unconfined Compression Test).....	18
5. Uji Triaksial.....	20
3.1.4 Kuat Geser Tanah.....	23
3.2 Tanah Berbutir Halus.....	24
3.2.1 Tanah Lempung.....	24
3.2.2 Tanah Lanau.....	24
3.3 Kapur Karbid (Lime Carbide).....	25
3.4 Daya Dukung Tanah.....	26
3.4.1 Analisis Kapasitas Dukung Tanah Teori Vesic.....	27
3.5 Stabilisasi Tanah.....	32
BAB IV METODE PENELITIAN.....	34
4.1 Bahan Penelitian.....	34
4.2 Alat Penelitian.....	34
4.3 Jalannya Penelitian.....	34
4.3.1 Tahap Persiapan.....	34
4.3.2 Tahap Pekerjaan Lapangan.....	35
4.3.3 Tahapan Pekerjaan Laboratorium.....	35
4.4 Jenis Pengujian.....	36
4.5 Bagan Alir Penelitian.....	37
BAB V Hasil Penelitian.....	38
5.1 Hasil Pengujian Tanah Asli.....	38

5.1.1	Sifat Fisik Tanah	38
5.1.2	Pengujian Kadar Air Tanah	38
5.1.3	Pengujian Berat Jenis Tanah.....	38
5.1.4	Pengujian Volume Tanah.....	39
5.1.5	Pengujian <i>Grain Size analysis</i>	40
5.1.6	Pengujian Batas Konsistensi Tanah.....	42
5.1.7	Pengujian Kepadatan	43
5.1.8	Pengujian Triaksial UU.....	44
5.1.9	Pengujian Tekan Bebas	47
5.2	Hasil Pengujian Tanah dicampur Kapur Karbid.....	49
5.2.1	Pengujian Triaksial UU Tanah dicampur Kapur Karbid	49
5.2.2	Hasil Pengujian Kuat Tekan Bebas.....	51
BAB VI PEMBAHASAN		53
6.1	Klasifikasi Tanah	53
6.1.1	Sistem Klasifikasi Tanah USCS.....	53
6.1.2	Sistem Klasifikasi AASHTO.....	55
6.2	Pengaruh Pencampuran Karbid terhadap Tanah Berbutir Halus	55
6.2.1	Analisis Kuat Dukung Tanah Teori Vesic.....	55
6.2.2	Analisis Kuat Dukung Tanah Undisturb.....	56
6.2.3	Analisis Kuat Dukung Tanah Yang Dicampur Karbid.....	58
BAB VII KESIMPULAN DAN SARAN.....		63
7.1	Kesimpulan	63
7.2	Saran	64
DAFTAR PUSTAKA.....		65
LAMPIRAN.....		67

DAFTAR NOTASI

❖ Tanah

V_a	= volume udara	(cm^3)
V_s	= volume butiran padat	(cm^3)
V_v	= volume pori	(cm^3)
W_s	= berat butiran padat	(gr)
W_w	= berat air	(gr)
γ	= berat volume tanah	(t/m^3)
γ_b	= berat volume basah	(t/m^3)
γ_d	= berat volume kering	(t/m^3)
γ_s	= berat volume butiran padat	(t/m^3)
γ_w	= berat volume air	(t/m^3)
e	= angka pori	(%)
n	= porositas	(%)

❖ Batas Konsistensi

LL	= batas cair	(%)
PI	= indeks plastis	(%)
PL	= batas plastis	(%)

❖ Kapasitas Kuat dukung Tanah untuk Pondasi

A	= luasan	(m^2)
B	= lebar	(m)
c	= kohesi	(t/m^2)
D_f	= kedalaman pondasi	(m)
N_c	= faktor kapasitas dukung tanah Vesic	
N_q	= faktor kapasitas dukung tanah Vesic	
N_γ	= faktor kapasitas dukung tanah Vesic	

P	= beban	(ton)
p_0	= tekanan overburden pada dasar pondasi	(t/m ²)
P_u	= beban ultimit	(ton)
SF	= Faktor aman	
q_a	= kapasitas dukung ijin tanah	(t/m ²)
q_u	= kapasitas dukung ultimit	(t/m ²)
q_n	= kapasita dukung neto	(t/m ²)
σ	= tegangan normal pada bidang tanah	(t/m ²)
φ	= sudut geser dalam tanah	(°)



DAFTAR TABEL

Tabel 3.1	Klasifikasi AASHTO bagi tanah dan campuran tanah-agregat	11
Tabel 3.2	Klasifikasi tanah sistem <i>Unified</i> untuk tanah lempung.....	13
Tabel 3.3	Nilai indeks plastisitas dan macam tanah	17
Tabel 3.4	Konsistensi tanah	20
Tabel 3.5	Komposisi kapur karbid	25
Tabel 3.6	Faktor bentuk pondasi	28
Tabel 3.7	Faktor kedalaman pondasi	28
Tabel 3.8	Faktor kemiringan beban	29
Tabel 3.9	Faktor kemiringan dasar pondasi	30
Tabel 3.10	Faktor kemiringan permukaan	30
Tabel 3.11	Faktor kapasitas dukung Vesic	30
Tabel 4.1	Jumlah benda uji yang digunakan.....	36
Tabel 5.1	Hasil pengujian kadar air.....	38
Tabel 5.2	Hasil pengujian berat jenis tanah	39
Tabel 5.3	Pengujian Berat Volume Tanah	39
Tabel 5.4	<i>Grain size analysis I</i>	40
Tabel 5.5	<i>Grain size analysis II</i>	41
Tabel 5.6	<i>Grain size analysis average</i>	41
Tabel 5.7	Hasil Pengujian Pemadatan Proktor Standar 1.....	43
Tabel 5.8	Hasil Pengujian Pemadatan Proktor Standar 2.....	44
Tabel 5.9	Hitungan tegangan pada tanah <i>undisturb</i> sampel I	46
Tabel 5.10	Hitungan tegangan pada tanah <i>undisturb</i> sampel II	46
Tabel 5.11	Hasil pengujian Triaksial UU tanah <i>undisturb</i>	47
Tabel 5.12	Hasil pengujian Tekan Bebas tanah <i>undisturb</i>	47
Tabel 5.13	Hasil pengujian Triaxial tanah dicampur kapur karbid.....	49
Tabel 5.14	Hasil pengujian Tekan Bebas tanah dicampur kapur karbid.....	51
Tabel 6.1	<i>Grain size analysis average</i>	53

Tabel 6.2	Perhitungan kuat dukung dan lebar pondasi dengan campuran kapur karbid pada pengujian Tekan Bebas	60
Tabel 6.3	Perhitungan kuat dukung dan lebar pondasi dengan campuran kapur karbid pada pengujian Triaksial	61



DAFTAR GAMBAR

Gambar 3.1	Grafik sistem klasifikasi tanah <i>unified</i>	12
Gambar 3.2	Diagram fase tanah	14
Gambar 3.3	Batas-batas Atterberg.....	16
Gambar 3.4	Alat pengujian batas cair.....	16
Gambar 3.5	Skema uji Tekan Bebas.....	19
Gambar 3.6	Diagram skematik alat uji Triaksial.....	23
Gambar 4.1	Bagan Alir Penelitian Tugas Akhir.....	37
Gambar 5.1	Grafik Analisis Butiran I.....	40
Gambar 5.2	Grafik Analisis Butiran II.....	41
Gambar 5.3	Grafik hubungan antara pukulan dengan kadar air 1	42
Gambar 5.4	Grafik hubungan antara pukulan dengan kadar air 2	42
Gambar 5.5	Kurva hubungan kadar air dengan berat volume kering tanah 1	43
Gambar 5.6	Kurva hubungan kadar air dengan berat volume kering tanah 2	44
Gambar 5.7	Grafik Lingkaran Mohr Uji Triaxial UU Tanah Undisturb Sampel I.....	46
Gambar 5.8	Grafik Lingkaran Mohr Uji Triaxial UU Tanah Undisturb Sampel II.....	47
Gambar 5.9	Grafik hubungan ϕ dengan Prosentase campuran kapur karbid pada uji Triaxial.....	50
Gambar 5.10	Grafik hubungan kohesi dengan Prosentase campuran kapur karbid pada uji Triaksial.....	50
Gambar 5.11	Grafik hubungan ϕ dengan Prosentase campuran kapur karbid pada uji Tekan Bebas.....	52
Gambar 5.12	Grafik hubungan kohesi dengan Prosentase campuran kapur karbid pada uji Tekan Bebas.....	52
Gambar 6.1	Klasifikasi tanah berdasarkan sistem <i>Unified</i>	54
Gambar 6.2	Grafik segitiga Klasifikasi Tanah	54
Gambar 6.3	Detail Fondasi	56

DAFTAR LAMPIRAN

- Lampiran 1** Pemeriksaan Kadar Air Tanah
- Lampiran 2** Pemeriksaan Berat Volume Tanah
- Lampiran 3** Pemeriksaan Berat Jenis Tanah
- Lampiran 4** Analisis Granuler
- Lampiran 5** Pengujian Batas Cair
- Lampiran 6** Pengujian Pemasatan
- Lampiran 7** Pengujian Tekan Bebas Tanah Undisturb
- Lampiran 8** Pengujian Tekan Bebas Tanah + Karbid 1.5%
- Lampiran 9** Pengujian Tekan Bebas Tanah + Karbid 3%
- Lampiran 10** Pengujian Tekan Bebas Tanah + Karbid 4.5%
- Lampiran 11** Pengujian Tekan Bebas Tanah + Karbid 6%
- Lampiran 12** Pengujian Tekan Bebas Tanah + Karbid 7.5%
- Lampiran 13** Pengujian Tekan Bebas Tanah + Karbid 10%
- Lampiran 14** Pengujian Triaksial Tanah Undisturb
- Lampiran 15** Pengujian Triaksial Tanah + Karbid 1.5 %
- Lampiran 16** Pengujian Triaksial Tanah + Karbid 3 %
- Lampiran 17** Pengujian Triaksial Tanah + Karbid 4.5 %
- Lampiran 18** Pengujian Triaksial Tanah + Karbid 6 %
- Lampiran 19** Pengujian Triaksial Tanah + Karbid 7.5 %
- Lampiran 20** Pengujian Triaksial Tanah + Karbid 10 %
- Lampiran 21** Analisis Kuat Dukung Tanah dengan Teori Vesic

BAB I

PENDAHULUAN

1.1 Latar Belakang

Berdasarkan asalnya, tanah dapat diklasifikasikan secara luas menjadi tanah organik atau anorganik. Tanah organik adalah campuran yang mengandung bagian-bagian yang cukup berarti berasal dari lapukan dan sisa tanaman dan kadang-kadang dari kumpulan kerangka dan kulit organisme kecil. Tanah anorganik berasal dari pelapukan batuan secara kimia ataupun fisis. Tanah inorganik yang tetap berada pada tempat terbentuknya dinamakan tanah residual. Apabila tanah telah dipindahkan ke lokasi lain oleh gravitasi, air, ataupun angin, dinamakan tanah pindahan (*transported soil*).

Tanah dalam pekerjaan Teknik Sipil selalu diperlukan, baik sebagai bahan konstruksi maupun pendukung beban. Kondisi tanah di setiap tempat tentulah berbeda karena secara alamiah tanah merupakan material yang rumit dan sangat bervariasi. Tanah sangat berperan penting dalam pekerjaan bangunan, baik sebagai bahan bangunan seperti tanggul dan bendungan atau sebagai pendukung bangunan di atasnya seperti pada jalan raya, jalan rel dan gedung. Untuk itu tanah harus memenuhi persyaratan kualitas baik secara fisik maupun teknis. Namun tidak semua tanah dalam keadaan aslinya memenuhi persyaratan kualitas yang diinginkan.

Mineral-mineral lempung terdiri dari silikat aluminium dan/ atau besi dan magnesium. Beberapa diantaranya juga mengandung alkali dan/ atau tanah alkalin sebagai komponen yang penting. Mineral-mineral ini terutama terdiri dari kristalin dimana atom-atom yang membentuknya tersusun dalam suatu pola geometris tertentu. Sebagian besar mineral lempung mempunyai struktur berlapis, beberapa diantaranya mempunyai bentuk silinder memanjang atau struktur yang berserat (Joseph E. Bowles, 1986).

Tanah lempung merupakan akumulasi partikel mineral yang lemah ikatan antar partikelnya, yang terbentuk dari pelapukan batuan. Diantara partikel-

partikelnya terdapat ruang kosong yang disebut pori (*void space*) yang berisi air atau udara. Ikatan yang lemah antar partikelnya disebabkan oleh karbonat atau dioksida bersenyawa diantara partikel-partikel tersebut, atau dapat juga disebabkan oleh adanya material organik (R.F. Craig, 1986).

Lanau merupakan tanah butir halus yang bersifat non plastis, dan tidak stabil dalam kehadiran air, lanau mendekati kepadatan, sulit untuk padat, dan memiliki kepekaan yang tinggi untuk mengeras.

Sifat tanah lempung dan lanau yang kurang baik dengan kekuatannya yang rendah dan pengembangan yang cukup besar, maka diperlukan usaha perbaikan sifat-sifat fisik dan sifat-sifat mekanis tanah untuk mencapai persyaratan teknis tertentu. Cara ini dikenal dengan Stabilisasi Tanah.

Stabilisasi tanah dapat dilakukan dengan beberapa metoda, salah satunya adalah stabilisasi mekanis dengan cara pengaturan gradasi butiran tanah kemudian dilakukan proses pemadatan, atau dengan cara menambahkan bahan tambah tertentu agar tanah memenuhi persyaratan konstruksi bangunan. Stabilisasi tanah, pencampuran tanah dengan bahan tambah (tanah, bahan aditif) untuk meningkatkan daya dukung tanah. Kuat / daya dukung tanah naik berarti terjadinya peningkatan kohesi dan sudut geser dalam tanah. Ada banyak bahan tambah yang dipakai sebagai bahan stabilisasi tanah berbutir halus diantaranya dengan menggunakan semen putih, arang aktif, batu kapur dan bahan-bahan lainnya yang bisa digunakan sebagai stabilisator untuk tanah berbutir halus. Untuk tugas akhir ini menggunakan kapur karbid untuk bahan stabilisasi tanah berbutir halus.

Pada industri las karbid terdapat sisa proses gas astilin yang dinamakan kapur karbid, bahan ini merupakan limbah bagi industri tersebut yang selama ini terabaikan dan kurang banyak dimanfaatkan. Kapur karbid yang digunakan pada penelitian ini berasal dari PT. Indo Hazel Perkasa, yang terletak di jalan Wates Km 12, Sedayu, Yogyakarta. Oleh karena itu pada tugas akhir ini akan dicoba menggunakan bahan aditif kapur karbid, untuk menganalisis peningkatan daya dukung tanah pada tanah berbutir halus dengan judul :

“Analisis Pengaruh Pencampuran Bahan Aditif Kapur Karbid Pada Tanah Berbutir Halus Di Bawah Dasar Pondasi Bangunan Terhadap Dimensi Pondasi Dengan Metode Vesic”

1.2 Rumusan Masalah

Untuk menjaga supaya penelitian tidak meluas dan melebar dari masalah yang dihadapi, diambil rumusan masalah, yaitu :

1. Seberapa besar pengaruh pencampuran tanah berbutir halus dengan kapur karbid terhadap dimensi pondasi dengan teori persamaan Vesic.
2. Seberapa besar perubahan kuat geser tanah lempung setelah ditambah dengan kapur karbid.

1.3 Tujuan Penelitian

Adapun tujuan yang hendak dicapai dalam pelaksanaan penelitian ini adalah :

1. Mengetahui klasifikasi tanah berdasarkan sifat-sifat fisik dan mekanis tanah berbutir halus yang berasal dari Pekalongan - Jawa Tengah.
2. Mengetahui pengaruh pencampuran kapur karbid terhadap sudut geser dalam dan kohesi tanah berbutir halus dengan perbandingan tertentu.
3. Mencari prosentase maksimum campuran tanah berbutir halus dengan kapur karbid yang dapat memberikan nilai sudut geser dalam maksimum yang digunakan sebagai perhitungan untuk penghematan dimensi pondasi dengan teori Vesic.

1.4 Batasan Masalah

Batasan masalah pada penelitian ini adalah sebagai berikut ini.

1. Lempung yang diambil dari daerah Cepagan, Pekalongan, Jawa Tengah.
2. Kapur karbid didapat dari PT. Indo Hazel Perkasa, yang terletak di jalan Wates Km 12, Sedayu, Yogyakarta.
3. Pencampuran bahan dalam keadaan kering (*dry mixing*).
4. Penelitian hanya terbatas pada sifat – sifat fisik dan mekanis tanah lempung, tidak menganalisis unsur kimia tanah lempung.

5. Proporsi campuran pada setiap berat kering tanah yang dicampur kapur karbid dengan variasi persentase campuran sebesar 1.5%, 3%, 4.5%, 6%, 7.5%, 10%.
6. Pengujian yang dilakukan adalah sebagai berikut :
 - a. Sifat-sifat tanah (kadar air, berat jenis, berat volume tanah, analisis granuler, batas cair, batas plastis)
 - b. Pengujian pemadatan tanah
 - c. Pengujian Triaksial tipe UU (*Unconsolidated Undrained*)
 - d. Pengujian Tekan Bebas
7. Dalam penelitian ini tidak ditinjau pengaruh perubahan temperatur sampel tanah lempung.
8. Penentuan untuk analisis daya dukung Vesic yaitu fondasi dangkal berbentuk bulat dengan prediksi beban bangunan (P) = 25 ton.
9. Penurunan bangunan tidak diperhitungkan.
10. Kondisi beban vertikal sentris dengan momen = 0 dan alas pondasi serta permukaan tanah horizontal.
11. Pengujian dilakukan di Laboratorium Mekanika Tanah, Jurusan Teknik Sipil, Fakultas Teknik Sipil dan Perencanaan, Universitas Islam Indonesia, Yogyakarta.

1.5 Manfaat Penelitian

Melalui penelitian ini diharapkan dapat diketahui pengaruh yang ditimbulkan oleh pencampuran kapur karbid terhadap mekanisme sifat fisik dan mekanis pada tanah berbutir halus. Penelitian ini diharapkan dapat melengkapi pengetahuan yang ada tentang kapur karbid sebagai bahan stabilisasi tanah berbutir halus sehingga dapat diaplikasikan dalam kasus-kasus geoteknik yang ada dilapangan.

BAB II

TINJAUAN PUSTAKA

Penelitian Terdahulu

Untuk penelitian ini mengacu pada hasil penelitian terdahulu sebagai tinjauan pustaka :

1. Penelitian Faratodi Syailendra dan M. Ali Faisal, 2005, **Analisis Pengaruh Penambahan Serbuk Arang Dan Kapur Karbid Pada Tanah Berbutir Halus Terhadap Parameter Kuat Geser Tanah**, TA Mahasiswa S1 JTS FTSP-UII.

a. Rumusan Masalah

Bagaimana pengaruh penambahan serbuk arang dan kapur karbid pada tanah berbutir halus yang berasal dari Majenang, Jawa Tengah. Adapun pengaruh disini adalah tegangan geser tanah setelah dicampur dengan bahan stabilitor, yakni serbuk arang dan kapur karbid.

b. Tujuan Penelitian

1. Mengetahui klasifikasi tanah berdasarkan sifat-sifat fisik dan mekanis tanah berbutir halus yang berasal dari Majenang- Jawa Tengah.
2. Mengetahui pengaruh penambahan serbuk arang dan kapur karbid terhadap kuat geser tanah berbutir halus.
3. Mencari prosentase maksimum campuran tanah berbutir halus dengan serbuk arang dan tanah berbutir halus dengan kapur karbid yang dapat memberikan kuat geser maksimal.

c. Hasil Penelitian

Beberapa kesimpulan yang dapat disampaikan dari hasil penelitian adalah sebagai berikut ini.

1. Tanah Majenang mempunyai batas plastis (WL) 61,19% dan indeks plastis (IP) 29,04% berdasarkan tingkat plastisitas, tanah berbutir halus Majenang menurut Bagan klasifikasi Tanah Unified adalah Lempung inorganic, yang memiliki plastisitas sedang sampai tinggi (OH), dan termasuk golongan lanau inorganic dan pasir sangat halus, tepung batuan , pasir halus berlanau, pasir halus berlanau

atau berlempung dengan sedikit plastisitas (MH) berdasarkan sistim Klasifikasi Tanah Unified. Berdasarkan hasil penelitian Grain size Analysis didapat kandungan pasir sebesar 5.035%, lanau sebesar 66.15%, dan lempung sebesar 28.15%. Maka menurut USCS tanah ini digolongkan dalam lanau berlempung.

2. Berdasarkan data yang diperoleh, pengaruh penambahan serbuk arang dan kapur karbid tanah berbtir halus asal Majenang, Jawa Tengah menyebabkan meningkatnya nilai kohesi dan sudut geser dalam tanah, sehingga meningkatnya tegangan geser dalam tanah.
3. Prosentase maksimum pada kondisi *Disturb* (w_{opt}) untuk Uji Triaksial dengan penambahan kapur karbid sebesar 3% dan lama pemeraman 7 hari dengan nilai sudut geser dalam (ϕ) sebesar 39.06° dan kohesi (c) sebesar $2.81 \text{ (kg/cm}^2\text{)}$, sedangkan untuk Uji Tekan Bebas penambahan kapur karbid sebesar 4% dan lama pemeraman 7 hari dengan nilai sudut geser dalam (ϕ) sebesar 42° dan kohesi (c) sebesar $0.67 \text{ (kg/cm}^2\text{)}$, dan untuk penambahan serbuk arang pada Uji Triaksial sebesar 4% dengan pemeraman 7 hari sedangkan pada Uji Tekan Bebas sebesar 4% dengan pemeraman 3 hari.

2. Penelitian Ade Rahardian, 2004, **Stabilisasi Tanah Lempung Dengan Bahan Tambah Kapur Karbid Dan Abu Sekam**, TA Mahasiswa S1 JTS FTSP-UII.

Sampel tanah yang digunakan adalah tanah lempung Sedayu dan bahan stabilisasi yang digunakan adalah campuran kapur karbid dengan abu sekam padi. Pengujian yang dilakukan adalah untuk memperoleh data parameter kuat geser tanah dan telah disesuaikan dengan standar ASTM (American Society for Testing Material) Perhitungan daya dukung tanah dilakukan dengan menggunakan metode Terzaghi. Variasi kadar kapur karbid yang digunakan adalah 0 %, 3 %, 6 %, 9 %, 12 %, dan 15 % terhadap berat isi kering tanah dengan waktu pemeraman 0 hari, 5 hari, 10 hari, 15 hari, dan 20 hari.

Hasil pengujian menunjukkan bahwa terjadi perubahan nilai parameter kuat geser tanah kohesi (c) dan sudut geser dalam (ϕ) setelah tanah dicampur dengan kapur. Hasil pengujian juga menunjukkan bahwa perubahan nilai parameter kuat

geser tanah kohesi (c) dan sudut geser dalam (ϕ) menyebabkan terjadinya peningkatan nilai daya dukung tanah pada kadar kapur karbid optimum.

Peningkatan ini seiring dengan bertambahnya waktu pemeraman. Data yang diperoleh adalah pada waktu pemeraman 0 hari nilai q_u sebesar $34,1964 \text{ kg/cm}^2$ dan menjadi $98,5958 \text{ kg/cm}^2$ pada waktu pemeraman 20 hari. Berdasarkan hasil pengujian ini terbukti pula bahwa terjadi peningkatan kualitas, kestabilan volume, kekuatan dan kemudahan pekerjaan akibat penambahan campuran kapur karbid dan abu sekam padi.

Penelitian yang akan kami teliti adalah peningkatan kuat geser tanah berbutir halus yang akan distabilisasi dengan kapur karbid, dengan sampel tanah berbutir halus berasal dari Pekalongan dan dianalisis dengan metode Vesic.



BAB III

LANDASAN TEORI

3.1 Tanah

3.1.1 Umum

Istilah “tanah” dalam bidang Mekanika Tanah dimaksudkan untuk mencakup semua bahan seperti lempung (clay), lanau, pasir, kerikil, sampai berangkal (batu-batu yang besar) ; jadi semua endapan alam yang bersangkutan dengan teknik sipil kecuali batuan tetap. Batuan tetap menjadi ilmu tersendiri, yaitu mekanika batuan (rock mechanics).

Semua macam tanah ini secara umum terdiri dari tiga bahan, yaitu butiran tanahnya sendiri, serta air dan udara yang terdapat dalam ruangan antara butir-butir tersebut. Ruangan ini disebut pori (voids). Apabila tanah sudah benar-benar kering maka tidak akan ada air sama sekali dalam porinya. Keadaan semacam ini jarang ditemukan pada tanah yang masih dalam keadaan asli dilapangan. Air hanya dapat dihilangkan sama sekali dari tanah apabila diambil tindakan khusus untuk maksud itu, misalnya dengan memanaskan didalam oven.

Sebaliknya sering ditemukan keadaan dimana pori tanah tidak mengandung udara sama sekali ; jadi pori tersebut menjadi penuh terisi air. Dalam hal ini tanah dikatakan jenuh air (*fully saturated*). Tanah yang terdapat dibawah muka air hampir selalu dalam keadaan jenuh air. Teori-teori yang dipergunakan dalam bidang Mekanika Tanah ini sebagian besar dimaksudkan untuk tanah yang jenuh air. Teori konsolidasi misalnya serta teori kekuatan geser tanah bergantung pada anggapan bahwa pori tanah hanya mengandung air, dan sama sekali tidak mengandung udara.

Di Indonesia sering terdapat tanah yang jenuh air sehingga perlu kita sadari bahwa pemakaian teori-teori tadi untuk tanah semacam ini sebenarnya kurang tepat. Walaupun demikian, jumlah udara yang terdapat pada tanah yang tidak jenuh air, biasanya sangat sedikit sehingga untuk keperluan soal-soal praktis masih dapat dianggap sebagai tanah yang jenuh air. (L.D Wesley, 1977).

Istilah pasir, lempung, lanau atau lumpur digunakan untuk menggambarkan ukuran partikel pada batas yang telah ditentukan. Kebanyakan jenis tanah terdiri dari banyak campuran lebih dari satu macam ukuran partikelnya. Tanah lempung belum tentu terdiri dari partikel lempung saja. Akan tetapi dapat bercampur dengan butir-butir ukuran lanau maupun pasir dan mungkin juga terdapat campuran bahan organik. Ukuran partikel tanah dapat bervariasi lebih besar dari 100 mm sampai dengan lebih kecil dari 0,001 mm. (Hary Christady Hardiyatmo, 1992).

3.1.2 Klasifikasi Tanah

Dari sudut pandangan teknis, tanah-tanah itu dapat digolongkan ke dalam kelompok berikut ini.

1. Batu kerikil (Gravel)
2. Pasir (Sand)
3. Lanau (Silt)
4. Lempung (Clay)

Golongan Batu Kerikil dan Pasir seringkali dikenal sebagai kelas bahan-bahan yang berbutir kasar atau bahan-bahan tidak kohesif, sedang golongan Lanau dan Lempung dikenal sebagai kelas bahan-bahan yang berbutir halus atau bahan-bahan yang kohesif.

Sistem klasifikasi digunakan untuk mengelompokkan tanah-tanah sesuai dengan perilaku umum dari tanah pada kondisi fisis tertentu. Tanah yang dikelompokkan dalam urutan berdasar satu kondisi fisik tertentu bisa saja mempunyai urutan yang tidak sama jika didasarkan kondisi fisik tertentu lainnya. Oleh karena itu sejumlah sistem klasifikasi telah dikembangkan disesuaikan dengan maksud yang diinginkan oleh sistem itu.

Berdasarkan pemakaiannya, saat ini ada dua sistem klasifikasi yang dapat digunakan untuk keperluan teknik yaitu *Unified Soil Classification Sistem* dan AASHTO (Hary Christady Hardiyatmo, 1992).

a) Sistem Klasifikasi AASHTO

Sistem Klasifikasi tanah AASHTO pada mulanya dikembangkan pada tahun 1920-an oleh U.S. Bureau of Public Roads guna mengklasifikasikan tanah untuk pemakaian lapisan dasar jalan raya. Sistem Klasifikasi AASHTO yang diperlihatkan dalam tabel 3.2 mengalami beberapa kali revisi hingga tahun 1945 yang dipergunakan hingga sekarang. Sistem ini didasarkan pada kriteria berikut ini.

1) Ukuran butir, dibagi menjadi kerikil, pasir, lanau, dan lempung.

- Kerikil : bagian tanah yang lolos ayakan dengan diameter 75 mm dan tertahan pada ayakan diameter 2 mm.
- Pasir : bagian tanah yang lolos ayakan dengan diameter 2 mm dan tertahan pada ayakan diameter 0,0075 mm.
- Lanau & Lempung : bagian tanah yang lolos ayakan dengan diameter 0,0075 mm.

2) Plastisitas, nama berlanau dipakai apabila bagian – bagian yang halus dari tanah mempunyai indeks plastisitas (IP) sebesar 10 atau kurang. Nama berlempung dipakai bila bagian – bagian yang halus dari tanah mempunyai indeks plastisitas sebesar 11 atau lebih.

3) Apabila batuan (ukuran lebih besar dari 75 mm) ditemukan dalam contoh tanah yang akan diuji maka batuan – batuan tersebut harus dikeluarkan terlebih dahulu, tetapi persentasi dari batuan yang dikeluarkan tersebut harus dicatat.

Klasifikasi tanah menurut AASHTO (*American Association of State Highway and Transportation Officials Classification*) berguna untuk menentukan kualitas tanah guna perencanaan timbunan jalan, *subbase* dan *subgrade*. Karena sistem ini ditujukan untuk maksud-maksud dalam lingkup tersebut, penggunaan sistem ini dalam prakteknya harus mempertimbangkan maksud aslinya. Klasifikasi AASHTO bagi tanah dan Campuran tanah agregat terdapat dalam Tabel 3.1.

Tabel 3.1 Klasifikasi AASHTO bagi Tanah dan Campuran Tanah-Agregat

Klasifikasi Umum	Bahan Granuler (35% atau kurang lolos 0.075 mm)										Bahan lanau-Lempung (Lebih dari 35% lolos 0.075 mm)					
	A-1		A-3	A-2			A-2-7	A-4	A-5	A-6	A-7	A-7-5	A-7-6			
	A-1-a	A-1-b		A-2-4	A-2-5	A-2-6										
Analisis Ayakan, Persen Lolos 2.00 mm (no. 10) 0.425 mm (no 40) 0.075 mm (no 200)	50 maks 30 maks 15 maks	50 maks 50 maks 25 maks	51 min 10 maks	35 maks	35 maks	35 maks	36 min	36 min	36 min	36 min	36 min					
Karakteristik dari Fraksi lolos 0.425 mm (no 40) Batas Cair																
Indeks Plastisitas	6maks		N.P - 10 maks	41 min 11 maks	40 maks 11 min	41 min 11 min	40 maks 10 maks	41 min 10 maks	40 maks 11 min	41 min 10 maks	41 min 11 min(a)					
Jenis unsur bahan penting pada umumnya	Fragmen Batu, Kerikil dan Pasir		Pasir Halus									Tanah Lempungan				
Penilaian umum sebagai Subgrade	Baik Sekali sampai Baik										Tanah Lanauan		Tanah Lempungan			
(a) = indeks plastisitas dari subkelompok A-7-5 sama dengan atau kurang dari LL dikurangi 30 indeks plastisitas dari subkelompok A-7-6 lebih besar dari LL dikurangi 30													Sedang sampai jelek			

(Sumber Irving S. Dunn, 1992)

b) **Klasifikasi Tanah Sistem *Unified***

Sistem klasifikasi tanah yang paling terkenal di kalangan para ahli teknik tanah dan pondasi adalah klasifikasi tanah sistem *Unified*. Sistem ini pertamakali dikembangkan oleh Casagrande (1948) dan dikenal sebagai sistem klasifikasi *Airfield*. Sistem ini telah dipakai dengan sedikit modifikasi oleh U.S. Bureau of Reclamation dan U.S. Corps of Engineers dalam tahun 1952. Dalam tahun 1969 American Society for Testing and Materials (ASTM) telah memakai sistem *Unified* sebagai metode standar guna mengklasifikasikan tanah untuk maksud-maksud rekayasa (ASTM D – 2487).

Klasifikasi tanah berdasarkan batas konsistensi tanah, menurut sistem klasifikasi *unified* adalah sebagai berikut:

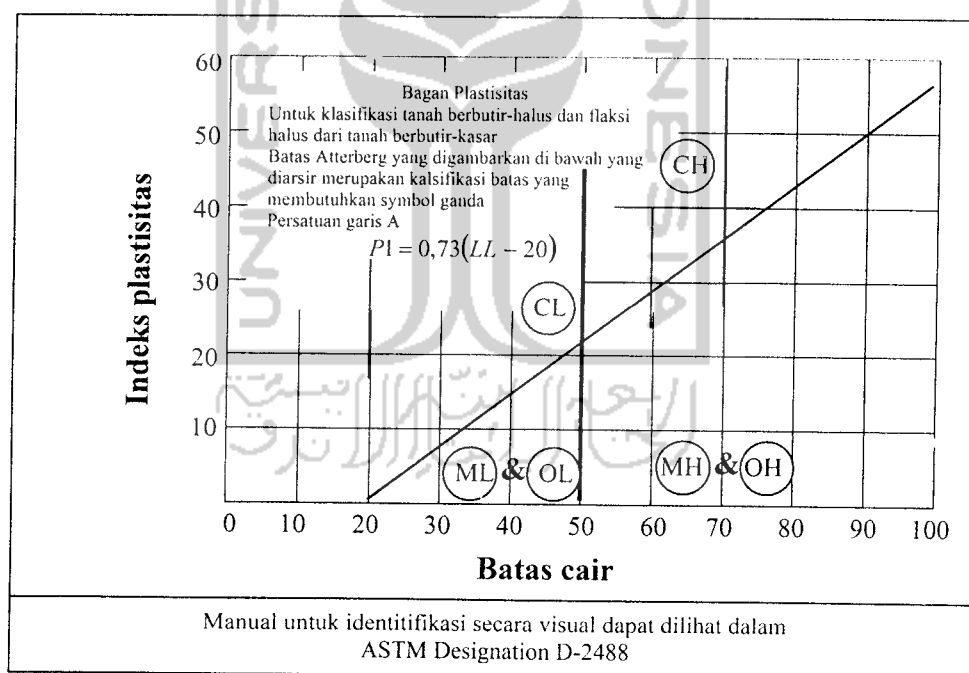

Gambar 3.1 Grafik Sistem Klasifikasi Tanah *Unified*

Sumber : Hary Christady Hardiyatmo , *Mekanika Tanah 1*, 1992, Hal 40

Tabel 3.2 Sistem Klasifikasi Tanah *Unified* Untuk Tanah Lempung

Lanau dan lempung batas cair 50% atau kurang	ML	Lanau tak organik dan pasir sangat halus, serbuk batuan atau pasir halus berlanau atau berlempung.
	CL	Lempung tak organik dengan plastisitas rendah sampai sedang, lempung berkerikil, lempung berpasir, lempung berlanau.
	OL	Lanau organik dan lempung berlanau organik dengan plastisitas rendah.
Lanau dan Lempung Batas Cair >50%	MH	Lanau tak organik atau pasir halus diatomae, lanau elastis
	CH	Lempung tak organik dengan plastisitas tinggi.
	OH	Lempung organik dengan plastisitas sedang sampai tinggi

Sumber : Hary Christady Hardiyatmo , *Mekanika Tanah 1*, 1992, Hal 40

3.1.3 Sifat- Sifat Tanah

a Sifat Fisik Tanah

Pengujian sifat fisik tanah bertujuan mengetahui warna, bentuk butiran dan ukuran butiran. Adapun pengujian yang dilakukan pada penelitian ini hanya untuk mengetahui ukuran butiran.

1. Uji Hidrometer

Cara hidrometer biasa digunakan, yaitu dengan memperhitungkan berat jenis suspensi yang bergantung dari berat butiran tanah dalam suspensi dalam suspensi pada waktu tertentu. Pengujian laboratorium dilakukan dengan menggunakan gelas ukur dengan kapasitas 1000 ml yang diisi dengan larutan air, bahan pendispersi dan tanah yang akan diuji. Analisis hidrometer didasarkan pada prinsip pengendapan (sendimentasi) butir- butir tanah dalam air.

2. Analisa Distribusi Butiran

Sifat- sifat tanah sangat bergantung pada ukuran butirannya. Besarnya butiran dijadikan dasar untuk pemberian nama dan klasifikasi tanahnya. Oleh karena itu, analisis butiran ini merupakan pengujian yang sering dilakukan. Analisis ukuran

butiran tanah adalah penentuan persentase berat butiran pada satu unit saringan, dengan ukuran diameter lubang tertentu.

b Sifat Mekanis Tanah

1. Indeks Properties Tanah

Pada segumpal tanah dapat terdiri dari dua atau tiga bagian. Dalam tanah yang kering hanya akan terdapat dua bagian, yaitu butir-butir tanah dan pori-pori udara. Dalam tanah yang jenuh juga terdapat dua bagian yaitu bagian padat atau butiran dan air pori. Dalam keadaan tidak jenuh, tanah terdiri dari tiga bagian yaitu bagian padat atau butiran, pori-pori udara dan air pori. Bagian-bagian dari tanah itu sendiri dapat digambarkan dalam bentuk diagram fase, seperti pada gambar 3.2 :

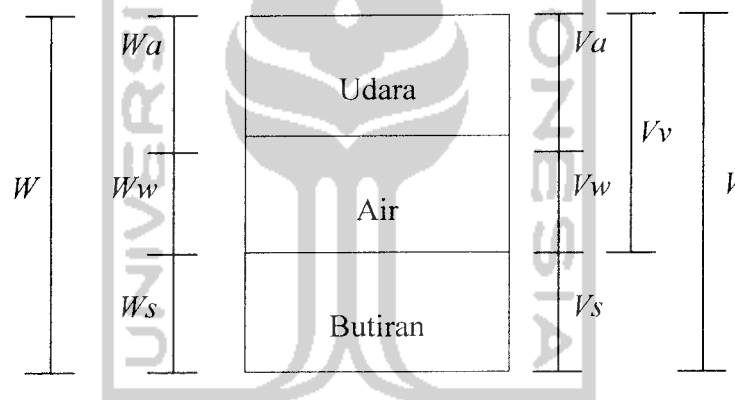

Gambar 3.2 Diagram Fase Tanah (HC Hardiyatmo, 1992)

Dari gambar tersebut dapat dibentuk persamaan sebagai berikut:

$$W = W_s + W_w$$

$$V = V_s + V_w + V_a$$

$$V_v = V_w + V_a$$

dengan:

W_s = berat butiran padat

W_w = berat air

V_s = volume butiran padat

V_w = volume air

V_a = volume udara

V_v = volume pori

Berat udara (W_a) dianggap sama dengan nol.

Beberapa definisi dan istilah yang dipakai untuk menyatakan hubungan-hubungan antara jumlah butir air dan udara dalam tanah sebagai berikut:

a. Kadar Air (w)

Kadar air (w) atau *water content* didefinisikan sebagai perbandingan antara berat air (W_w) dengan berat butiran padat (W_s) dari volume tanah yang diselidiki

$$w = \frac{W_w}{W_s} \times 100\% \dots\dots\dots(3.1)$$

b. Berat Isi Tanah

Berat isi tanah (γ) adalah berat tanah per satuan volume, dengan rumus dasar:

$$\gamma = \frac{W_w + W_s}{V} \dots\dots\dots(3.2)$$

c. Berat Jenis (*Spesific Gravity, G_s*)

Berat jenis adalah perbandingan antara volume butiran tanah dengan volume air

$$G_s = \frac{\gamma_s}{\gamma_w} = \frac{W_w}{V_s \cdot \gamma_w} \dots\dots\dots(3.3)$$

Berat jenis tidak mempunyai satuan.

2. Batas-Batas Konsistensi Tanah

Apabila tanah berbutir halus mengandung mineral lempung, maka tanah tersebut bila diremas tidak akan pecah/ retak. Sifat kohesif ini disebabkan karena adanya air yang terserap (*absorbed water*) dikeliling partikel lempung. Atterberg dari Swedia telah mengembangkan suatu metoda untuk menjelaskan sifat konsistensi berbutir halus pada kadar air yang bervariasi. Bila kadar air tinggi, campuran tanah dan air menjadi sangat lembek seperti cairan. Atas dasar air yang dikandung tanah, tanah dapat dibedakan menjadi empat keadaan dasar yaitu: padat, semi padat, plastis dan cair, seperti pada Gambar 3.3.

Kadar air dinyatakan dalam persen, pada transisi dari keadaan padat ke semi padat disebut batas susut (*shrinkage limit*). Kadar air pada transisi dari keadaan

semi padat ke plastis disebut batas plastis (*plastis limit*) dan dari keadaan plastis ke keadaan cair dinamakan batas cair (*liquid limit*).

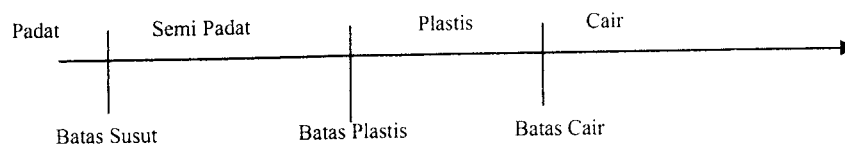

Gambar 3.3 Batas- Batas Atterberg (Braja M.Das, 1988)

a) Batas Cair/ *Liquid Limit* (LL).

Batas Cair didefinisikan sebagai kadar air pada kondisi ketika tanah mulai berubah dari plastis menjadi cair atau sebaliknya yaitu batas antara keadaan cair dan keadaan plastis. Batas cair ditentukan dari pengujian casagrande yaitu dengan cara tanah diletakkan didalam mangkok kuningan dan digoreskan tepat ditengah-tengahnya kemudian mangkok tersebut diketuk-ketuk hingga tanah menyatu kembali. Gambar skematis dari alat pengukur batas cair dapat dilihat pada Gambar 3.4.

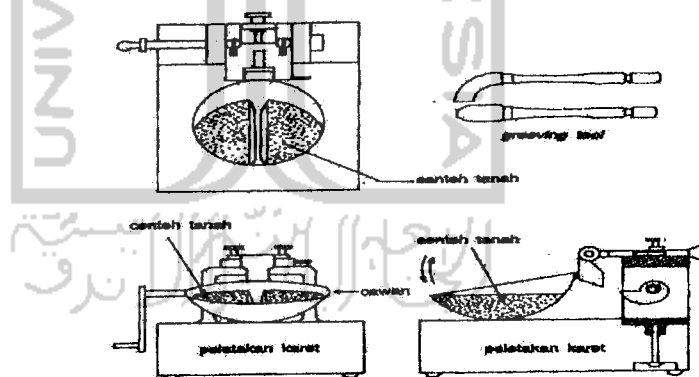

Gambar 3.4 Alat pengujian batas cair

Sumber : Hary Christady Hardiyatmo, 1992, *Mekanika Tanah 1*, Hal 32

Karena sulitnya mengatur kadar air pada waktu celah menutup pada 25 kali pukulan, maka biasanya percobaan dilakukan beberapa kali yaitu dengan kadar air yang berbeda dan jumlah pukulan yang berkisar antara 10 sampai 45 kali pukulan. Kemudian hubungan kadar air dan jumlah pukulan digambarkan dalam grafik untuk menentukan kadar air pada 25 kali pukulan.

b) Batas Plastis/ *Plastic Limit* (PL)

Didefinisikan sebagai kadar air pada kedudukan antara daerah plastis dan semi padat, yaitu prosentase kadar air pada saat tanah mulai retak.

Dengan:

M1 = berat tanah basah dalam cawan percobaan (gr)

M2 = berat tanah kering oven (gr)

V1 = volume tanah basah dalam cawan (cm³)

V2 = volume tanah kering oven (cm³)

c) Indeks Plastis/ *Plasticity Index* (PI)

Indeks plastis tanah adalah selisih antara batas cair dan batas plastis tanah.

Indeks plastis didapatkan berdasarkan rumus:

$$PI = LL - PL \dots \dots \dots (3.4)$$

Dengan: PI = indeks plastisitas

LL = batas cair

PL = batas plastis

Batasan mengenai indeks plastisitas, sifat, macam tanah dan kohesi diberikan oleh Atterberg terdapat dalam Tabel 3.3.

Tabel 3.3 Nilai indeks plastisitas dan macam tanah

PI	Sifat	Macam Tanah	Kohesi
0	Non Plastis	Pasir	Non kohesif
< 7	Plastisitas rendah	Lanau	Kohesif sedang
7 - 17	Plastisitas sedang	Lempung berlanau	Kohesif
> 17	Plastisitas tinggi	Lempung	Kohesif

Sumber : Hary Christady Hardiyatmo, 1992 , *Mekanika Tanah 1*, hal 34

3. Uji Proktor Standar

Pengujian ini dilakukan untuk mencari hubungan kadar air dengan berat volume tanah, dan untuk mengevaluasi tanah agar memenuhi persyaratan kepadatan. Selanjutnya terdapat satu nilai optimum tertentu untuk mencapai nilai berat volume kering yang maksimum. Derajat kepadatan tanah diukur dari berat volume

keringnya. Hubungan berat volume berat kering (γ_k) dengan berat volume basah (γ_b) dan kadar airnya (w) dinyatakan:

$$\gamma_k = \frac{\gamma_b}{1 + w} \dots\dots\dots(3.5)$$

Kurva yang dihasilkan dari pengujian menunjukkan nilai kadar air yang terbaik untuk mencapai berat volume kering terbesar atau kepadatan maksimum (MDD). Kadar air pada keadaan ini disebut kadar air optimum (*Optimum Moisture Content*) atau OMC.

Pemadatan tanah berpengaruh pada kualitas tanah, yaitu:

1. meningkatkan kuat geser tanah.
2. mengurangi sifat mudah mampat dan permeabilitas.
3. mengurangi perubahan volume sebagai akibat pengurangan kandungan air maksimum yang dapat mengisi pori- pori.

Untuk penambahan volume air pada campuran tanah opt + bahan stabilitor, dinyatakan:

$$V = W_{camp} * \left(\frac{100 + OMC}{100 + W_{mula}} - 1 \right) \dots\dots\dots(3.6)$$

Dengan : V = Volume air yang ditambahkan

W_{camp} = berat tanah + bahan tambah

OMC = kadar air optimum

W_{mula} = kadar air awal

4. Uji Tekan Bebas (Unconfined Compression Test)

Pengujian tekan bebas termasuk hal yang khusus dari pengujian triaksial *unconsolidated-undrained* (tanpa terkonsolidasi tanpa drainasi). Kondisi pembebanannya sama dengan yang terjadi pada uji Triaksial, hanya tegangan selnya nol (σ_3). Maksud dari percobaan ini adalah untuk menentukan besarnya sudut gesek dalam tanah (ϕ), kohesi tanah (c), dan kuat tekan tanah. Kuat tekan bebas tanah adalah tekanan vertical yang diberikan untuk menekan silinder tanah sampai pecah atau besarnya tekanan yang menyebabkan pemendekan tanah hingga 20%, bila tanah

sampai pemendekan 20% tidak pecah. Benda uji berbentuk silinder , tinggi silinder harus antara 2 sampai 3 kali diameter.

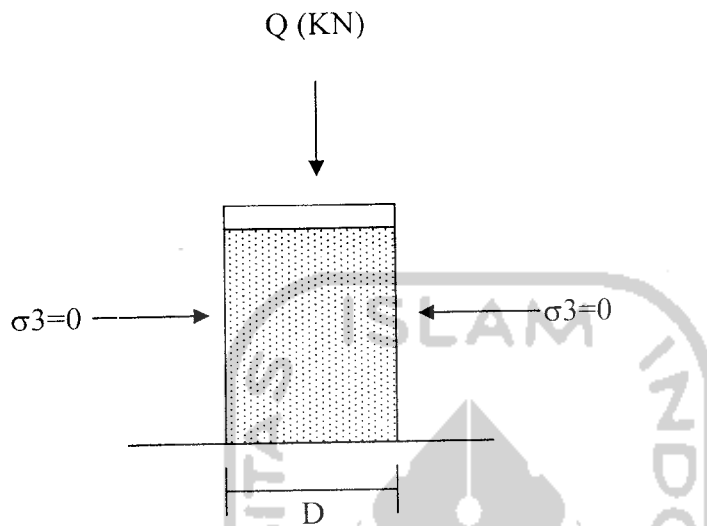

Gambar 3.5 Skema uji Tekan Bebas

Kuat tekan bebas dinyatakan dalam:

$$q_u = \frac{Q}{A} \dots\dots\dots(3.7)$$

dengan : q_u = kuat tekan bebas

Q = besar tekanan vertical

A = luas permukaan

Menghitung kohesi tanah dinyatakan dalam:

$$c = \frac{q_u}{2 \operatorname{tg} \alpha} \dots\dots\dots(3.8)$$

dengan : c = kohesi tanah (t/m^2)

α = sudut pecah ($^\circ$)

Menghitung sudut gesek tanah dinyatakan dalam:

$$\phi = 2(\alpha - 45) \dots\dots\dots(3.9)$$

dengan : ϕ = sudut gesek dalam tanah ($^\circ$)

α = sudut pecah tanah ($^\circ$)

Konsistensi Tanah diukur dari besarnya q_u , sehingga dapat dibedakan menjadi beberapa tingkatan, seperti ditunjukkan pada Tabel 3.4 berikut ini.

Tabel 3.4 Konsistensi Tanah dipandang dari segi kuat kompresi bebas

Konsistensi	Qu (KN/m ²)
Sangat lunak	0 – 25
Lunak	25 – 50
Sedang / Medium	50 – 100
Kenyal / Stiff (kaku)	100 – 200
Sangat kenyal	200 – 400
Keras / Hard	> 400

(Sumber : Irving S. Dunn, Loren R. Andreson, dan Fred W. Kiefer. *Dasar-dasar Analisis Geoteknik*, 1992, Hal 31)

5. Uji Triaksial

Pada pengujian triaksial ini dilakukan bertujuan untuk mengetahui besarnya tegangan geser (σ_1) juga besarnya tegangan normal (σ_3). Setelah mengetahui besarnya tegangan geser dan tegangan normal maka dapat dicari nilai kohesi (c) dan sudut geser dalam (ϕ) dari suatu tanah.

Tiga cara yang dilaksanakan pada pengujian Triaksial, antara lain :

- a) Pengujian dengan cara terkonsolidasi dengan drainasi (*consolidated – drained*).

Mula-mula tegangan sel tertentu diterapkan pada benda uji dengan katup drainasi terbuka sampai konsolidasi selesai. Kemudian dengan katup drainasi tetap terbuka, tegangan deviator diterapkan dengan kecepatan yang rendah sampai benda uji runtuh. Kecepatan pembebanan yang rendah dimaksudkan agar dapat menjamin tekanan air pori nol selama proses penggeserannya. Pada kondisi ini seluruh tegangan selama proses pengujian ditahan oleh gesekan antar butirannya.

- b) Pengujian dengan cara terkonsolidasi – tanpa drainasi (*concolidated - undrained*).

Tipe uji triaksial ini yang paling umum digunakan. Pada mulanya sampel tanah yang jenuh air mula-mula dikonsolidasikan dengan tekanan penyekap (*confining pressure*) yang sama dari segala penjuru dalam tabung berisi fluida, kemudian

dibebani dengan beban normal melalui penerapan tegangan deviator selama penggeserannya dan tidak diijinkan air keluar dari benda ujinya. Jadi selama pengujian katup drainasi ditutup, karena pada pengujiannya air tidak diijinkan mengalir keluar dan beban normal tidak ditransfer ke butiran tanahnya. Keadaan tanpa drainasi ini menyebabkan adanya tekanan kelebihan tekanan pori dengan tidak ada tahanan geser hasil perlawanan dari butiran tanahnya.

c) Pengujian dengan cara tanpa terkonsolidasi – tanpa drainasi (*unconsolidated – undrained*).

Pada pengujian ini tidak dibolehkan mengalirnya air ke benda uji selama memberikan tekanan sel (σ_3) dan diujikan sampai benda uji tersebut mengalami keruntuhan. Pada umumnya pengujian ini kita lakukan dengan sampel tanah lempung, dan uji ini menyajikan konsep kekuatan geser tanah yang sangat penting untuk tanah berkohesi yang jenuh air. Tambahan tegangan aksial pada saat tanah mencapai keruntuhan akan selalu sama besarnya, berapapun harga tegangan sel yang ada. Pada pengujian ini menggunakan pengujian Triaksial tipe UU (*Unconsolidate-Undrained*).

Alat yang digunakan

1. Alat Triaksial
2. Silinder contoh
3. Penumbuk untuk memadatkan tanah
4. Membran karet
5. Pengatur ketinggian
6. Pengatur hampa udara
7. Timbangan
8. Oven
9. Pencatat waktu

Prosedur pengujian

1. Mengukur diameter dan tinggi dari sampel benda uji kemudian ditimbang untuk menghitung volume.
2. Membebaskan udara dari pipa-pipa penghubung pada plat dasar sel Triaksial.
3. Pelat bawah dihubungkan dengan dasar sel.

4. Ambil membran karet dengan ukuran hampir sama dengan ukuran sampel tanah.
5. Masukkan contoh tanah yang sudah diletakkan diatas pelat dasar sel Triaksial kedalam tabung pengencang membran, kemudian diikat dengan karet supaya air tidak masuk kedalam sampel tanah.
6. Pasang tabung sel Triaksial dan keraskan baut pengencangnya.
7. Isi ruang sel dengan air, dengan cara memutar regulator pengatur tekanan sel kemudian buka kran yang menghubungkan tangki air dengan sel Triaksial sehingga air mengalir masuk memenuhi ruang sel Triaksial.
8. Berikan tekanan sel (σ_3) sesuai dengan harga yang diinginkan.
9. Jalankan piston beban dengan pemutar tangan sehingga hampir menyentuh benda uji, baca dan catat arloji beban yang akan mengukur gaya akibat tekanan keatas oleh air sel.
10. Mesin dijalankan dengan kecepatan 0.5 – 1.0 persen/menit, pembacaan dilakukan pada arloji cincin beban dan arloji pemendekan benda uji sampai tanah pecah atau pemendekan mencapai 20%.

Untuk pengujian ini, digunakan cara *Unconsolidate-Undrained* (UU) karena relatif cepat dalam pengujiannya. Persamaan kuat geser pada kondisi *Undrained* dapat dinyatakan dalam persamaan:

$$C_u = \frac{\sigma_1 - \sigma_3}{2} = \frac{\Delta\sigma_{df}}{2} = \frac{qu}{2} \dots\dots\dots(3.10)$$

dengan: $\Delta\sigma_{df}$ = tegangan deviator

C_u = kohesi undrained

Diagram skematik dari peralatan pengujian Triaksial dapat dilihat pada Gambar 3.6.

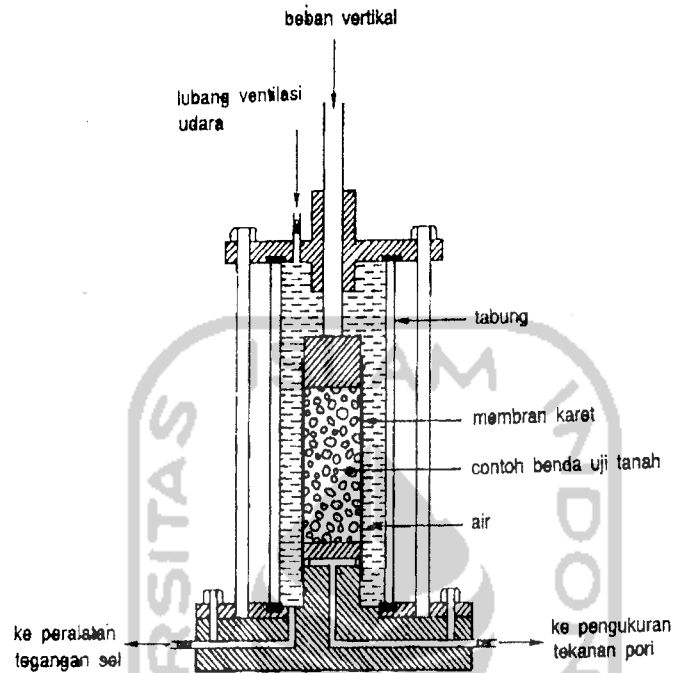

Gambar 3.6 Diagram skematik dari peralatan pengujian Triaksial

Sumber : Hardiyatmo, H.C, 1955, Mekanika Tanah 1, Hal 175

3.1.4 Kuat Geser Tanah

Parameter kuat geser tanah diperlukan untuk analisis-analisis daya dukung tanah, stabilitas lereng, dan tegangan dorong untuk dinding penahan tanah. Mohr (1910) memberikan teori mengenai kondisi keruntuhan suatu bahan, bahwa keruntuhan suatu bahan dapat terjadi oleh akibat adanya kombinasi keadaan kritis dari tegangan normal dan tegangan geser pada bidang runtuhnya.

Fungsi antara tegangan normal dan tegangan geser dengan bidang runtuhnya, dinyatakan dengan persamaan:

$$\tau = f(\sigma) \dots\dots\dots(3.11)$$

dengan : τ = tegangan geser (pada saat runtuh)

σ = tegangan normal

Menurut Coloumb (1776) kekuatan geser tanah dinyatakan dengan persamaan berikut:

$$\tau = c + \sigma g \phi \dots\dots\dots(3.12)$$

dengan : τ = kuat geser tanah (t / m^2)

c = kohesi tanah (t / m^2)

ϕ = sudut gesek dalam tanah ($^{\circ}$)

σ = tegangan normal pada bidang runtuh (t / m^2)

Pada kondisi dilapangan, kuat geser tanah dipengaruhi oleh:

1. Keadaan tanah (Kerikil, pasir, berpasir, lempung, dan sebagainya)
2. Jenis tanah (Kerikil, pasir, lanau, lempung, dan sebagainya)
3. Kadar air
4. Jenis beban dan tingkatnya. Dari teori konsolidasi dapat kita ketahui bahwa beban yang cepat akan menghasilkan tekanan pori yang berlebih.
5. Anisotropis, kekuatan yang tegak lurus terhadap bidang dasar adalah berbeda jika dibandingkan dengan kekuatan yang sejajar dengan bidang tersebut.

Untuk kondisi dilaboratorium kuat geser sangat dipengaruhi oleh:

1. Metode pengujian yang dilakukan
2. Gangguan terhadap contoh tanah
3. Kadar air
4. Tingkat regangan

3.2 Tanah Berbutir Halus

3.2.1 Tanah Lempung

Lempung terdiri dari butir-butir yang sangat kecil dan menunjukkan sifat-sifat plastisitas dan kohesi. Kohesi menunjukkan kenyataan bahwa bagian-bagian butir tersebut melekat satu sama lainnya, sedangkan plastisitas adalah sifat yang memungkinkan bahan tersebut dirubah- rubah tanpa perubahan isi atau tanpa kembali pada bentuk awal, dan tanpa terjadi retak / pecah.

3.2.2 Tanah Lanau

Adalah bahan yang merupakan peralihan antara lempung dan pasir halus. Kurang plastis dan lebih mudah ditembus air dari pada lempung dan memperlihatkan sifat dilatasi yang tidak terdapat pada lempung. Dilatasi ini menunjukkan gejala

untuk menjadi "quick" ("hidup") apabila diguncang atau digetarkan. (L. D Wesley, 1977).

3.3 Kapur karbid (*Lime Carbide*)

Kapur karbid, dikutip dari laporan penelitian berjudul Stabilisasi Tanah Lempung Menggunakan Limbah Industri oleh Setyo Winarno pada tahun 1996, adalah sisa proses pembuatan gas astilin yang berupa kapur kalsium tinggi. Sifat-sifat fisik yang dimiliki kapur karbid mirip dengan kalsium hidroksida, antara lain:

- a. mempunyai daya ikat air yang cukup tinggi
- b. bersifat non plastis, karena merupakan bahan berbutir
- c. mempunyai bau karbid yang khas
- d. senyawa kimia yang terbesar adalah CaO
- e. mempunyai kemampuan yang cepat untuk mengendapkan Lumpur yang terlarut dalam air
- f. dapat merusak kulit

Kapur karbid yang dipakai sebagai bahan stabilisasi pada tanah lempung Sedayu telah diuji komposisi kimianya oleh Superintending Company of Indonesia (SCI) di Surabaya. (Setyo Winarno, 1996). Berikut tabel komposisi kabir karbid (SCI):

Tabel 3.5 Komposisi Kapur Karbid

No	Senyawa Kimia	Kadar
1.	$\text{Fe}_2\text{O}_3 + \text{Al}_2\text{O}_3$	3,49%
2.	CaO total	59,07%
3.	CaO aktif	25,39%
4.	MgO	0,89%
5.	Pb	63 ppm
6.	Cu	12 ppm
7.	P	44 ppm
8.	Bahan hilang	24,93%
9.	Bahan tak larut	1,19%

3.4 Daya Dukung Tanah

Dalam perencanaan pondasi gedung atau bangunan lain ada dua hal utama yang harus diperhatikan, yaitu :

1. Daya dukung tanah ; yaitu apakah tanah yang bersangkutan cukup kuat untuk menahan beban pondasi tanpa terjadi keruntuhan akibat menggeser (*shear failure*). Tentu saja hal ini tergantung pada kekuatan geser tanah.
2. Penurunan yang akan terjadi, hal ini tergantung pada macam tanah.

Daya dukung ultimit (q_u) didefinisikan sebagai beban maksimum per satuan luas di mana tanah masih dapat mendukung beban tanpa mengalami keruntuhan (*Hary Christady Hardiyatmo, 2002, hal 87*). Persamaannya adalah :

$$q_u = \frac{Pu}{A} \quad (3.13)$$

dengan :

$$q_u = \text{daya dukung ultimit (t/m}^2\text{)}$$

$$Pu = \text{beban ultimit (t)}$$

$$A = \text{luas pondasi (m}^2\text{)}$$

Daya dukung ijin (q_a) adalah tekanan fondasi maksimum yang dapat dibebankan pada tanah, sedemikian hingga kedua persyaratan keamanan terhadap kapasitas dukung dan penurunannya terpenuhi (*Hary Christady Hardiyatmo, 2002, hal 100*).

$$q_a = \frac{q_u}{SF} \quad (3.14)$$

dengan :

$$q_a = \text{daya dukung ijin (t/m}^2\text{)}$$

$$q_u = \text{daya dukung ultimit (t/m}^2\text{)}$$

$$SF = \text{faktor aman}$$

Daya dukung ijin neto dari fondasi adalah beban persatuan luas yang diijinkan untuk suatu pondasi tanpa memasukkan berat tanah disebelah kanan dan kiri fondasi dari permukaan tanah sampai dengan kedalaman dasar fondasi yang besarnya adalah $p_o = \gamma \cdot D_f$. Jadi beban neto dapat dilihat dalam persamaan :

$$q_n = q_a - p_o \quad (3.15)$$

dengan :

$$q_n = \text{daya dukung neto (t/m}^2\text{)}$$

$$p_o = \text{tekanan overburden pada dasar pondasi (t/m}^2\text{)}$$

3.4.1 Analisis Kapasitas Dukung Tanah teori Vesic

Persamaan kapasitas dukung Vesic (1975) memberikan pengaruh-pengaruh seperti kedalaman, bentuk pondasi, kemiringan dan eksentrisitas beban, kemiringan dasar dan kemiringan permukaan (*Hary Christady Hardiyatmo, 2002, hal 147*).

Rumus Vesic :

$$q_u = \frac{Q_u}{B' L'} = s_c \cdot d_c \cdot i_c \cdot b_c \cdot g_c \cdot c \cdot N_c + s_q \cdot d_q \cdot i_q \cdot b_q \cdot g_q \cdot p_o \cdot N_q + s_\gamma \cdot d_\gamma \cdot i_\gamma \cdot b_\gamma \cdot g_\gamma \cdot 0,5 \cdot B \cdot \gamma \cdot N_\gamma \quad (3.16)$$

dengan :

Q_u = beban vertikal ultimit (t)

B = lebar pondasi (m)

L', B' = panjang dan lebar efektif fondasi (m)

γ = berat volume tanah (t/m³)

c = kohesi tanah (t/m²)

p_o = $D_f \gamma$ = tekanan overburden di dasar fondasi (t/m²)

s_c, s_q, s_γ = faktor-faktor bentuk fondasi (tabel 3.6)

d_c, d_q, d_γ = faktor-faktor kedalaman fondasi (tabel 3.7)

i_c, i_q, i_γ = faktor-faktor kemiringan beban (tabel 3.8)

b_c, b_q, b_γ = faktor-faktor kemiringan dasar (tabel 3.9)

g_c, g_q, g_γ = faktor-faktor kemiringan permukaan (tabel 3.10)

N_c, N_q, N_γ = faktor-faktor kapasitas dukung Vesic (tabel 3.11)

Tabel 3.6 Faktor bentuk fondasi

Faktor bentuk	Fondasi Memanjang	Fondasi empat persegi panjang	Fondasi bujursangkar atau lingkaran
Sc	1	$1 + (B/L) (Nq/Nc)$	$1 + (Nq/Nc)$
Sq	1	$1 + (B/L) \operatorname{tg} \varphi$	$1 + \operatorname{tg} \varphi$
Sy	1	$1 - 0.4 (B/L) \geq 0.6$	0.6

Sumber : Hary Christady Hardiyatmo, Teknik Pondasi 1, hal 148

Tabel 3.7 Faktor kedalaman fondasi

Faktor bentuk	Nilai	Keterangan
dc	$1 + 0.4(D/B)$	Batasan : Bila $(D/B) > 1$, maka (D/B) diganti dengan $\operatorname{arc} \operatorname{tg} (D/B)$
dq	$1 + 2 (D/B) \operatorname{tg} \varphi (1 - \sin \varphi)^2$	
dy	1	

Sumber : Hary Christady Hardiyatmo, Teknik Pondasi 1, hal 148

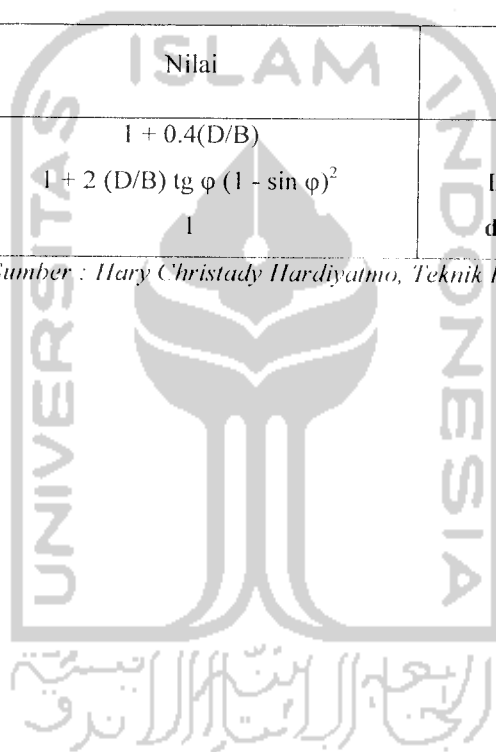

Tabel 3.8 Faktor kemiringan beban

Faktor kemiringan beban	Nilai	Keterangan
ic	$i_q - \frac{1-i_q}{N_c \text{tg} \varphi}$	Untuk $\varphi > 0$
ic'	$1 - \frac{mH}{A' c_a N_c}$	Untuk $\varphi = 0$
iq	$\left[1 - \frac{H}{V + A' c_a \text{ctg} \varphi} \right]^m \geq 0$	Untuk $V/A' c_a \leq 1$
iy	$\left[1 - \frac{H}{V + A' c_a \text{ctg} \varphi} \right]^{m+1} \geq 0$	Untuk dasar horisontal
	$m = m_B = \frac{2 + B/L}{1 + B/L}$	Kemiringan beban searah lebar B
	$m = m_L = \frac{2 + L/B}{1 + L/B}$	Kemiringan beban searah panjang L
	Jika inklinasi beban pada arah n dan	$H \leq c_a A' + V \text{tg} \delta$
	Membuat sudut θ_n terhadap arah L fondasi, maka m_n diperoleh dari : $m_n =$	
	$m_L \cos^2 \theta_n + m_B \sin^2 \theta_n$	

Sumber : Hary Christady Hardiyatmo, Teknik Pondasi I, hal 149

Tabel 3.9 Faktor kemiringan dasar fondasi

Faktor kemiringan dasar	Nilai	Keterangan
bc	$b_q - \frac{1 - b_q}{N_c \operatorname{tg} \varphi}$	α dalam radian φ dalam derajat
bc'	$1 - \frac{2\alpha}{\pi + 2}$	
bq = by	$(1 - \alpha \operatorname{tg} \varphi)^2$	

Sumber : Hary Christady Hardiyatmo, Teknik Pondasi 1, hal 149

Tabel 3.10 Faktor kemiringan permukaan

Faktor kemiringan dasar	Nilai	Keterangan
gc	$i_q - \frac{1 - i_q}{5,14 \operatorname{tg} \varphi}$	β dalam radian
gc'	$1 - \frac{2\beta}{\pi + 2}$	Batasan : $\beta < 45^\circ$ dan
gq = gy	$(1 - \operatorname{tg} \beta)^2$	$\beta < \varphi$

Sumber : Hary Christady Hardiyatmo, Teknik Pondasi 1, hal 150

Tabel 3.11 Faktor –faktor kapasitas dukung Vesic

Φ	N_c	N_q	N_γ
0	5,14	1,00	0,00
1	5,38	1,09	0,07
2	5,63	1,20	0,15

Lanjutan Tabel 3.11 Faktor –faktor kapasitas dukung Vesic

Φ	N_c	N_q	N_γ
3	5,90	1,31	0,24
4	6,19	1,43	0,34
5	6,49	1,57	0,45
6	6,81	1,72	0,57
7	7,16	1,88	0,71
8	7,53	2,06	0,86
9	7,92	2,25	1,03
10	8,34	2,47	1,22
11	8,80	2,71	1,44
12	9,28	2,97	1,69
13	9,81	3,26	1,97
14	10,37	3,59	2,29
15	10,98	3,94	2,65
16	11,63	4,34	3,06
17	12,34	4,77	3,53
18	13,10	5,26	4,07
19	13,93	5,80	4,68
20	14,83	6,40	5,39
21	15,81	7,07	6,20
22	16,88	7,82	7,13
23	18,05	8,66	8,20
24	19,32	9,60	9,44
25	20,72	10,66	10,88
26	22,25	11,85	12,54
27	23,94	13,20	14,47
28	25,80	14,72	16,72
29	27,86	16,44	19,34
30	30,14	18,40	22,40
31	32,67	20,63	25,99
32	35,49	23,18	30,21
33	38,64	26,09	35,19
34	42,16	29,44	41,06
35	46,12	33,30	48,03

Φ	N_c	N_q	N_y
36	50,59	37,75	56,31
37	55,63	42,92	66,19
38	61,35	48,93	78,02
39	67,87	55,96	92,25
40	75,31	64,20	109,41
41	83,86	73,90	130,21
42	93,71	85,37	155,54
43	105,11	99,01	186,53
44	118,37	115,31	224,63
45	133,87	134,87	271,75
46	152,10	158,50	330,34
47	173,64	187,21	403,65
48	199,26	222,30	496,00
49	229,92	265,50	613,14
50	266,88	319,06	762,86

Sumber : Hary Christady Hardiyatmo, Teknik Pondasi 1, hal 122

3.5 Stabilisasi Tanah

Bilamana mudah diperoleh bahan dengan kualitas yang baik, maka dapat melaksanakan stabilisasi tanah pondasi dengan hanya merubah kadar air tanah asli atau dengan penggilasan dan tidak perlu mengadakan pekerjaan yang khusus seperti pekerjaan perbaikan dengan penambahan bahan stabilisasi.

Tetapi kadang-kadang untuk mendapatkan stabilisasi yang tinggi, tanah asli yang terdapat di lapangan terpaksa diberi juga bahan stabilisasi, oleh karena tanah tersebut mempunyai karakteristik yang tidak memenuhi syarat. Ada dua sebab mengapa perbaikan stabilitas diperlukan pada lapisan yang dangkal.

1. Perbaikan karakteristik mekanis tanah sebagai bahan untuk meningkatkan kekuatan atau kekakuan dari bangunan yang terbuat dari tanah.
2. Perbaikan karakteristik yang tidak diinginkan dari tanah pondasi yang terdapat pada lapisan bawah atau yang menyebabkan rembesan atau "heaving" sewaktu diadakan penggalian.

Berikut ini adalah ringkasan masalah yang memerlukan perbaikan stabilitas pada lapisan yang dangkal.

1. Diperlukan kekuatan yang tinggi atau kekakuan.
2. Diperlukan untuk mengurangi efek meteorologi dan menjamin stabilitas untuk periode yang lama.
3. Penggunaan tanah yang terdapat di lokasi pembangunan.
4. Penggunaan bahan-bahan yang tidak memenuhi syarat.
5. Penambahan pada pemadatan yang tidak cukup.
6. Diperlukan untuk lalu lintas.
7. Diperlukan untuk menjamin stabilitas penggalian dan pengangkutan.
8. Diperlukan untuk perbaikan tanah yang sangat lunak.

Ada dua metode utama yang digunakan untuk mengadakan peningkatan stabilitas lapisan dangkal untuk memenuhi tuntutan-tuntutan tersebut di atas, yakni metode fisik seperti pemadatan dan metode kimia seperti pencampuran atau penyuntikan kapur karbid, semen dan bahan aditif lainnya. (Suyono Sosrodarsono dan Kazuto Nakazawa, 1990).

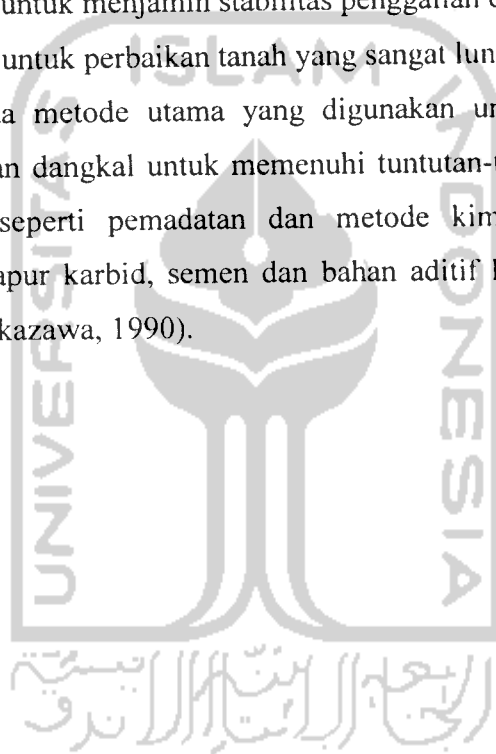

BAB IV

METODE PENELITIAN

4.1 Bahan Penelitian

1. Tanah

Dalam penelitian ini tanah yang digunakan adalah tanah lempung yang berasal dari Cepagan, Pekalongan, Jawa Tengah.

2. Air

Air berasal dari PDAM Laboratorium Mekanika Tanah, Jurusan Teknik Sipil, Universitas Islam Indonesia, Yogyakarta.

3. Kapur Karbid

Untuk kapur karbid didapat dari pabrik PT. Indo Hazel Perkasa, Jalan Wates KM 12, Sedayu, Yogyakarta.

4.2 Alat Penelitian

Peralatan yang digunakan dalam penelitian tugas akhir ini adalah alat-alat yang berkaitan dengan sifat tanah dan sifat mekanis tanah berdasarkan standarisasi American Society for Testing Material (ASTM).

4.3 Jalannya Penelitian

Penelitian dilaksanakan dalam tiga tahap, yaitu : Persiapan, pekerjaan lapangan dan pekerjaan Laboratorium.

4.3.1 Tahap Persiapan

Tahap persiapan meliputi :

- a) Studi Lapangan.
- b) Mengumpulkan informasi dan data mengenai tanah lempung, kapur karbid.
- c) Pengajuan proposal dan mengurus perijinan untuk kegiatan penelitian.

4.3.2 Tahapan Pekerjaan Lapangan

Pekerjaan lapangan adalah menentukan tempat dan lokasi pengambilan sampel dilanjutkan pengambilan sampel tanah lempung. Sampel tanah yang diambil adalah tanah lempung terganggu (*disturb soil*) dan tanah lempung tidak terganggu (*undisturb soil*). Sampel tanah adalah tanah lempung dari Cepagan, Pekalongan, Jawa Tengah.

4.3.3 Tahapan Pekerjaan Laboratorium

Penelitian ini dilaksanakan di Laboratorium Mekanika Tanah, Jurusan Teknik Sipil, Universitas Islam Indonesia, Yogyakarta. Pekerjaan Laboratorium adalah pengujian sifat – sifat tanah asli dalam kondisi (*disturb*), dan pengujian tanah dicampur kapur karbid dengan variasi campuran 1.5%, 3%, 4.5%, 6%, 7.5%, dan 10%.

Pengujian pendahuluan dilaksanakan untuk memeriksa karakteristik atas sifat – sifat tanah yang terdiri dari :

1. Pengujian Kadar Air (ASTM D 2216-71).
2. Pengujian Berat Jenis Tanah (ASTM D 854-72).
3. Pengujian Batas Cair (ASTM D 423-66).
4. Pengujian Batas Susut (ASTM D427-74).
5. Pengujian Batas Plastis (ASTM D 424-74).
6. Pengujian Analisis Saringan (ASTM D 422-72).

Setelah dilakukan pengujian sifat fisik tanah, kemudian dibuat rancangan campuran (*mix design*) sebagai model benda uji.

Selanjutnya dilakukan pengujian sifat mekanis dari benda uji berupa :

1. Analisa Distribusi Butiran (USCS dan AASTHO).
2. Pengujian Proctor Standar (ASTM D 698-70) untuk mengetahui Kadar air optimum / OMC (W_{opt}) dalam persen (%) dan Kepadatan maksimum / MDD (γ_k) dalam (N/cm^3).
3. Uji Tekan Bebas dan Uji Triaxial UU (ASTM D 2850) untuk mengetahui Kohesi (c) dalam (kg/cm^2), dan Besar Sudut Gesek Dalam Tanah (ϕ) dalam ($^{\circ}$), dan Kuat Tekan Tanah (q_u) dalam (kg/cm^2).

4.4 Jenis Pengujian

Jenis Pengujian dan jumlah sampel pengujian yang dilakukan di Laboratorium seperti yang tertera pada Tabel 4.1 berikut ini.

Tabel 4.1 Jumlah Benda Uji yang Digunakan

No	Jenis Pengujian	Benda Uji	Jumlah Sampel	Total
1.	Pengujian Kadar air	-	2	2
2.	Pengujian Berat Jenis	-	2	2
3.	Pengujian Berat Volume	-	2	2
4.	Pengujian Batas Cair	-	2	2
5.	Pengujian Batas Plastis	-	2	2
6.	Pengujian Batas Susut	-	2	2
7.	Analisis Granuler	-	2	2
8.	Pengujian Tekan Bebas (Tanah <i>Undisturb</i>)	1	2	2
9.	Pengujian Triaxial UU (Tanah <i>Undisturb</i>)	3	2	6
10.	Pengujian Proktor	5	2	10
11.	Uji Tekan Bebas (Tanah + Karbid) Pem. 3 hari, 7 hari, 14 hari			
	• Tanah + 1,5% Karbid	1	6	6
	• Tanah + 3% Karbid	1	6	6
	• Tanah + 4,5% Karbid	1	6	6
	• Tanah + 6 % Karbid	1	6	6
	• Tanah + 7.5 % Karbid	1	6	6
	• Tanah + 10 % Karbid	1	6	6
12.	Uji Triaxial UU (Tanah + karbid) Pem. 3 hari, 7 hari, 14 hari			
	• Tanah + 1,5% Karbid	3	6	18
	• Tanah + 3% Karbid	3	6	18
	• Tanah + 4,5% Karbid	3	6	18
	• Tanah + 6 % Karbid	3	6	18
	• Tanah + 7.5 % Karbid	3	6	18
	• Tanah + 10 % Karbid	3	6	18

4.5 Bagan Alir Penelitian

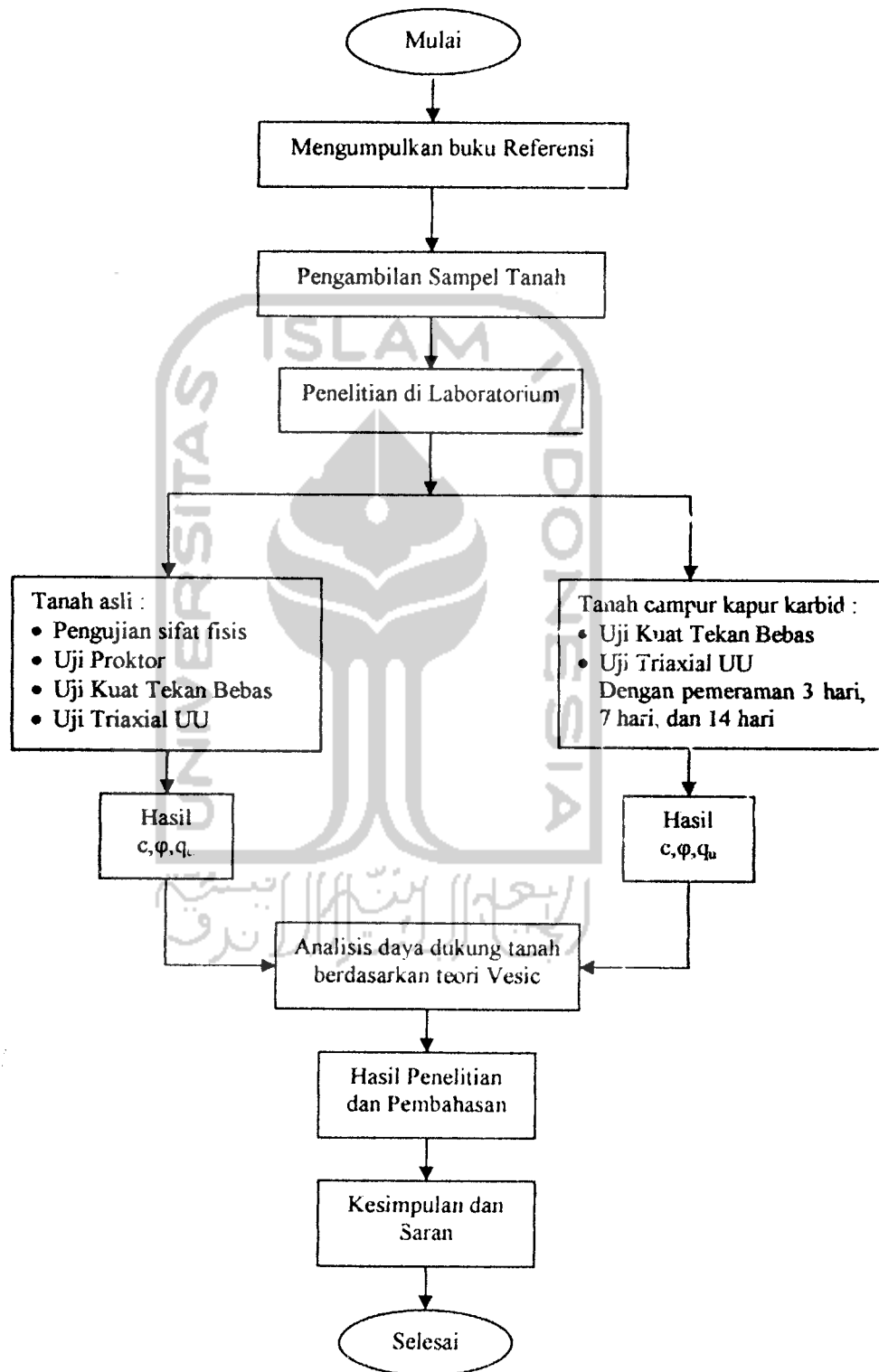

Gambar 4.1 Bagan Alir Penelitian

BAB V
HASIL PENELITIAN

5.1. Hasil Pengujian Tanah Asli

5.1.1 Sifat fisik tanah

Dilihat dari sifat fisiknya diketahui bahwa tanah Cepagan, Pekalongan, Jawa Tengah berwarna merah kecoklatan, lengket, dan mengandung pasir.

5.1.2 Pengujian Kadar Air Tanah

Tujuan pengujian ini adalah untuk mengetahui besarnya kadar air yang terkandung dalam tanah. Berdasarkan hasil pengujian yang dilakukan pada tanah asli didapat besar kadar air 56,362%.

Tabel 5.1. Hasil Pengujian Kadar Air

1	No Pengujian	1		2	
		a	b	a	b
2	Berat Container (W1)	21.66	21.8	21.55	21.98
3	Berat Container + Tanah Basah (W2)	55.79	53.21	52.74	44.78
4	Berat Container + Tanah Kering (W3)	43.53	41.87	41.52	36.53
5	Berat Air (Wa)	12.26	11.34	11.22	8.25
6	Berat Tanah Kering (Wt)	21.87	20.07	19.97	14.55
7	Kadar Air (Wa/Wt) x 100%	56.059	56.502	56.184	56.701
8	Kadar Air rata-rata (%)	56.362			

5.1.3 Pengujian Berat Jenis Tanah

Pengujian berat jenis bertujuan untuk menentukan berat jenis suatu sampel tanah, berat jenis tanah adalah nilai perbandingan berat butiran tanah dengan berat air destilasi di udara dengan volume yang sama pada temperature tertentu biasanya diambil pada suhu 27.5⁰ C. Hasil dari pengujian berat jenis tanah dapat dilihat pada Tabel 5.2 berikut ini.

Tabel 5.2. Hasil Pengujian Berat Jenis Tanah

No.	Kedalaman	1.2 meter	
		1	2
1	No pengujian	1	2
2	Berat Picknometer (W1)	20.75	21.85
3	Berat Picknometer +tanah kering (W2)	36.53	41.04
4	Berat Picknometer + tanah + air (W3)	80.49	92.83
5	Berat Picknometer + air (W4)	70.8	81.13
6	Temperatur (t°)	23.00	23.00
7	Bj pata temperatu (t°)	0.997	0.997
8	Bj pata temperatu (27,5° C)	0.996	0.996
7	Berat tanah kering (Wt)	15.78	19.19
8	A = Wt + W4	86.58	100.32
9	I = A - W3	6.09	7.49
10	Berat Jenis tanah, Gs = Wt / I	2.59	2.56
11	Bret Jenis = Gs. (Bj t° / Bj t 27,5° C)	2.5915	2.5624
12	Berat jenis rata-rata	2.58	

5.1.4 Pengujian Berat Volume Tanah

Pengujian berat volume bertujuan untuk mengetahui berat volume suatu sampel tanah. Hasil dari pengujian berat volume dapat dilihat pada Tabel 5.3 berikut ini.

Tabel 5.3 Pengujian berat volume tanah

1	No Pengujian	1		2	
		1	2	1	2
2	Diameter ring (d)	3.98	3.98	3.98	3.98
3	Tinggi cincin (t)	7.6	7.6	7.6	7.6
4	Volume ring (V)	94.504	94.504	94.504	94.504
5	Berat ring (W1)	135.65	135.65	135.65	135.65
6	Berat ring + tanah basah (W2)	277.04	274.47	274.47	274.47
7	Berat tanah basah (W2-W1)	161.74	158.96	158.96	158.96
8	Berat volume tanah (γ)	1.711	1.682	1.682	1.682
9	Berat volume rata-rata (gr/cm ³)	1.697			

Dari hasil pengujian berat volume tanah maka dapat diketahui tanah Pekalongan, Jawa Tengah mempunyai berat volume 1,697 gr/cm³.

5.1.5 Pengujian Grain Size Analysis

Tujuan penelitian ini untuk mengetahui butir-butir tanah serta prosentasenya berdasarkan batas-batas klasifikasi jenis tanah, sehingga dapat diketahui jenis tanah yang diuji, (Lihat Lampiran No. 4)

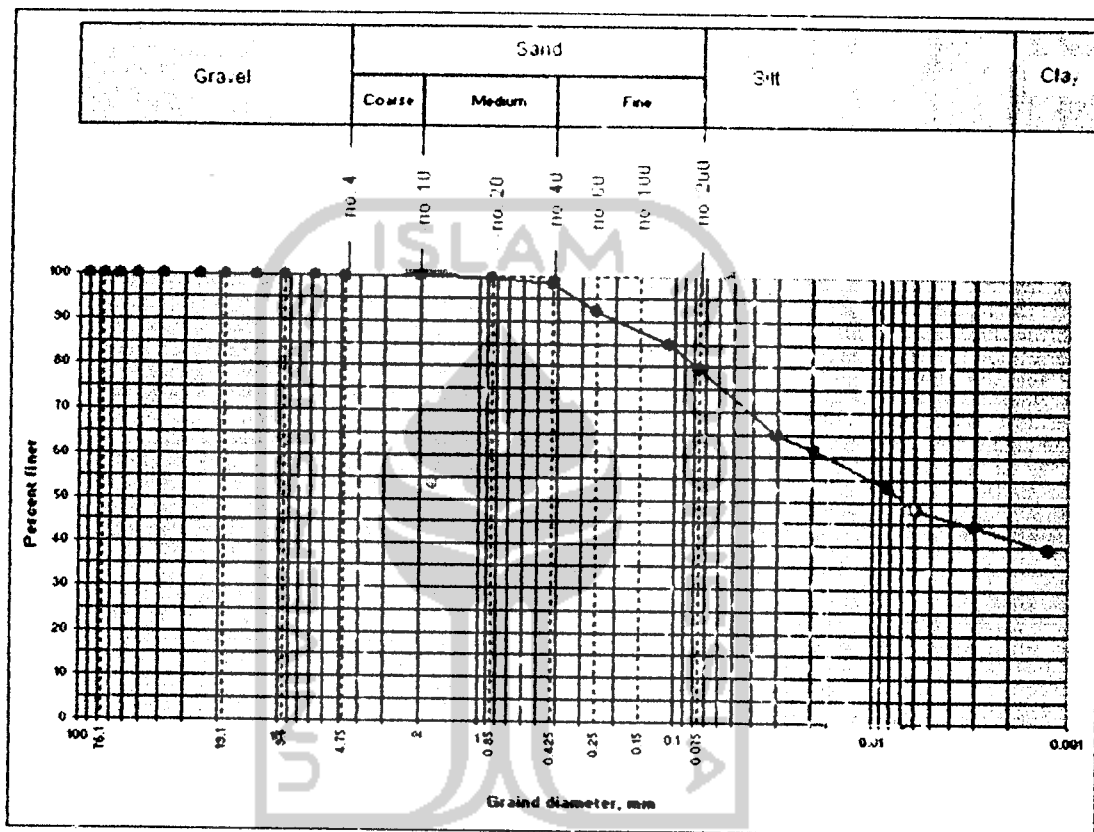

Gambar 5.1 Grain Size Analysis 1

Tabel 5.4 Grain Size Analysis 1

Gravel	0,00%
Sand	20.40%
Silt	37.774%
Clay	41.826%

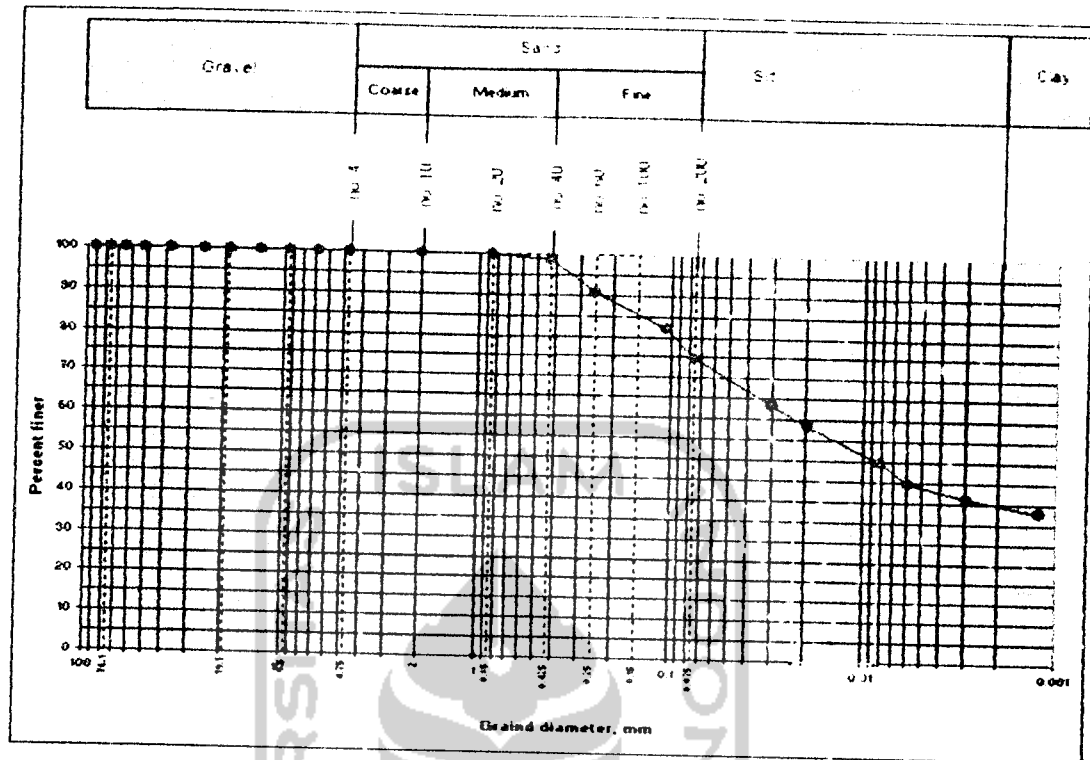

Gambar 5.2 Grain Size Analysis 2

Tabel 5.5 Grain Size Analysis 2

Gravel	0,00%
Sand	25.30%
Silt	35.434%
Clay	39.266%

Dari hasil kedua pengujian dapat diambil rata-rata, hasil rata-rata tersebut dapat dilihat dibawah ini.

Tabel 5.6 Grain Size Analysis (Average)

Gravel	0,00%
Sand	22.85%
Silt	36.604%
Clay	40.546%

5.1.6 Pengujian Batas Konsistensi Tanah

Pengujian ini bertujuan untuk mengetahui batas-batas kecairan atau kekentalan dari keadaan yang satu ke keadaan yang lain.

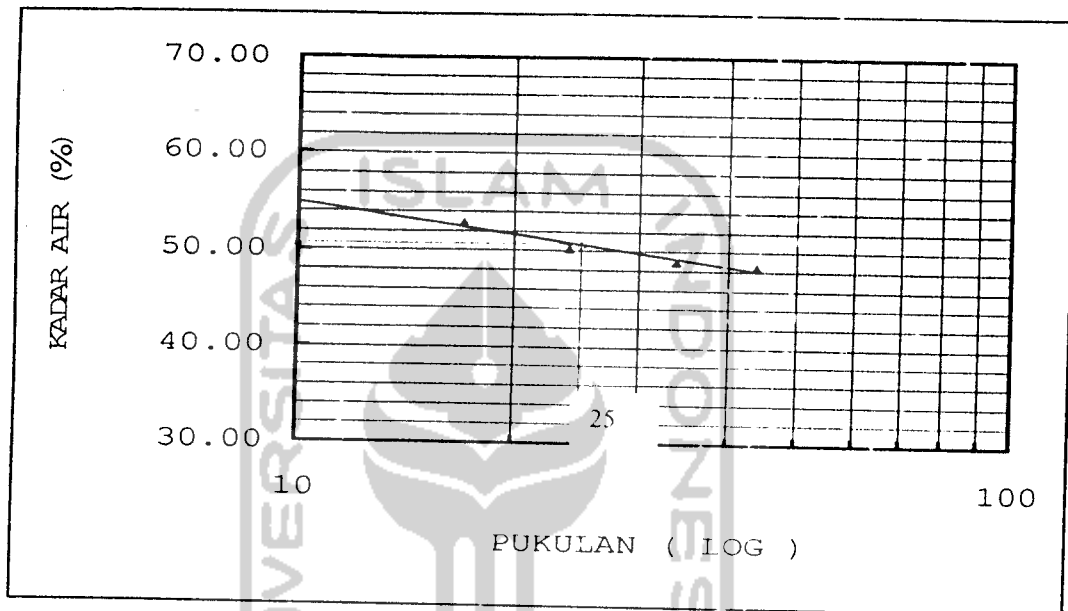

Gambar 5.3 Grafik hubungan antara pukulan dengan kadar air (1)

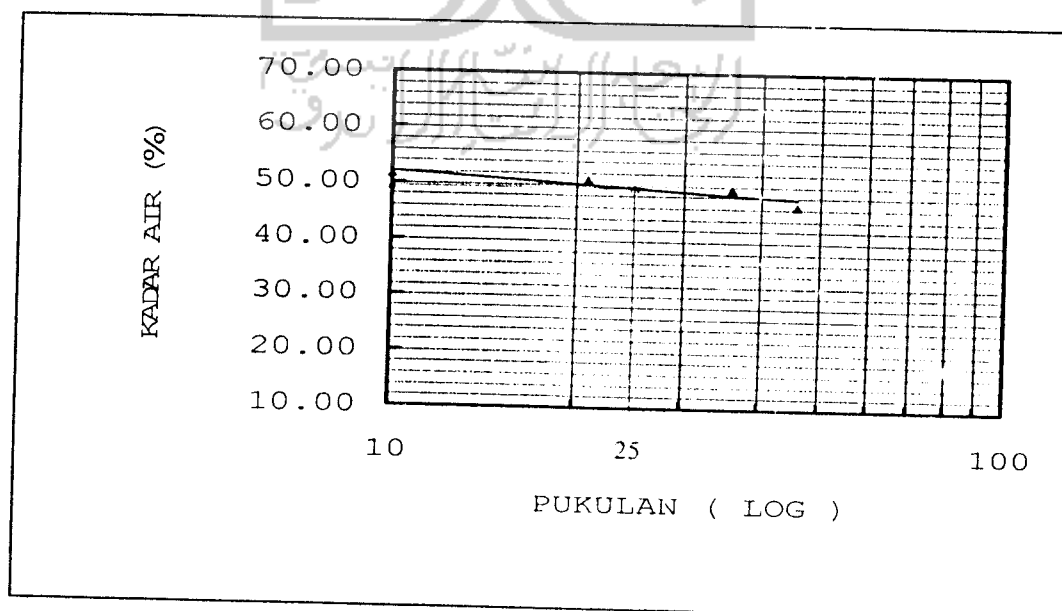

Gambar 5.4 Grafik hubungan antara pukulan dengan kadar air (2)

Hasil pengujian pada tanah berbutir halus Undisturbed didapat rata-rata data seperti berikut ini. (Lihat Lampiran No. 5)

Batas Cair (LL) : 49.975 %

Batas Plastis (PL) : 35.545 %

Indeks Plastisitas : 14.43 %

5.1.7 Pengujian Kepadatan

Pengujian Kepadatan dilakukan untuk mendapatkan harga kadar air optimum (W_{opt}) dan berat volume kering (γ_d) maksimum dari sampel tanah. Hasil pengujian proctor standar (lampiran 6) dapat dilihat pada Tabel 5.6 dan Tabel 5.7.

Tabel 5.7 Hasil pengujian proktor standar I

Percobaan	1	2	3	4	5
Kadar air rata-rata (%)	16.16	22.31	27.80	31.44	39.39
Berat volume tanah kering (gr/cm^3)	1.007	1.126	1.288	1.172	1.074

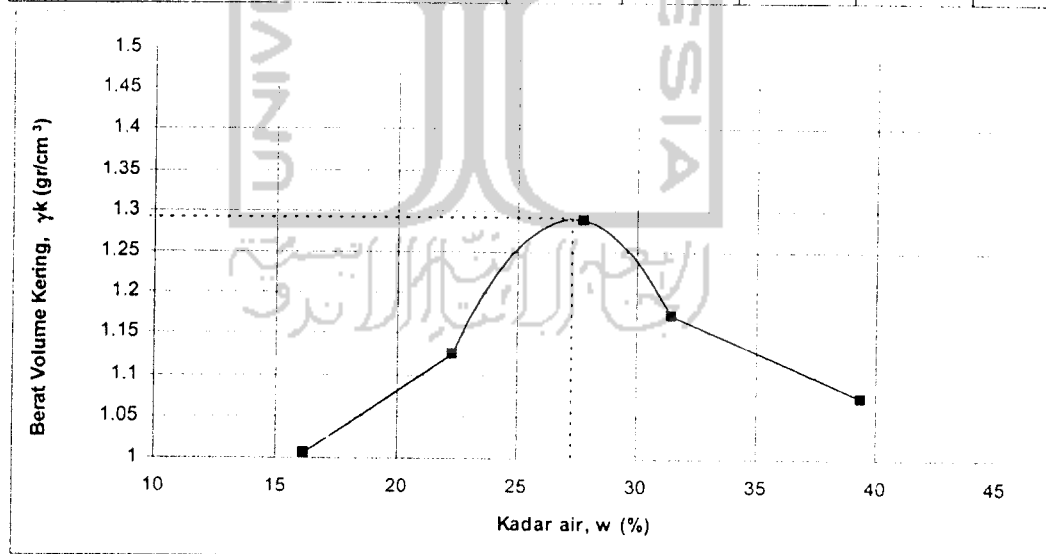

Gambar 5.5 Kurva hubungan kadar air dengan berat volume tanah kering(1)

Dari kurva hubungan kadar air dengan berat volume tanah kering, maka didapatkan :

Kadar air optimum = 27.25 %

Berat volume kering maksimum = 1.28994 gr/cm^3

Tabel 5.8 Hasil pengujian proktor standar II

Percobaan	1	2	3	4	5
Kadar air rata-rata (%)	15.31	23.73	30.08	31.80	40.98
Berat volume tanah kering (gr/cm^3)	1.262	1.319	1.329	1.318	1.200

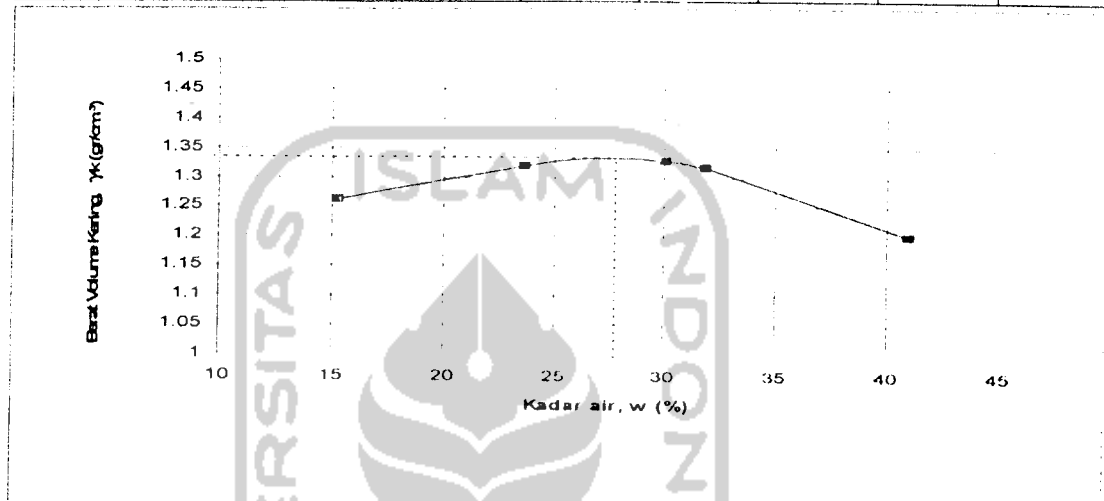
**Gambar 5.6** Kurva hubungan kadar air dengan berat volume tanah kering (II)

Hasil pengujian pemadatan dengan standar Proctor pada tanah lempung *disturbed* didapatkan data rata-rata sebagai berikut .

Kadar air optimum = 27.71 %

Berat volume kering maksimum = 1.33434 gr/cm^3

Dari hasil pengujian Proktor Standar, Sebagai pedoman pencampuran sampel benda uji pada pengujian Triaksial UU dan Tekan Bebas adalah kadar air optimum 27.71 % dan Berat Volume kering maksimum 1.33434 gr/cm^3 . Untuk analisis berikut digunakan nilai-nilai tersebut.

5.1.8 Pengujian Triaksial UU

Pengujian Triaksial tipe UU dilakukan pada sampel benda uji tanah asli dengan jumlah sampel sebanyak 3 buah, yaitu untuk tegangan sel (σ_3) 0.25 kg/cm^2 , tegangan sel (σ_3) 0.5 kg/cm^2 dan tegangan sel (σ_3) 1 kg/cm^2 , (Lihat Lampiran No. 14).

Contoh perhitungan tegangan sampel tanah *undisturb* :

Pada detik ke-30 pembacaan dial diperpendekkan 0.4 mm dengan $\sigma_3 = 0.25 \text{ kg/cm}^2$.

$$K = 0.165$$

$$L_o = 7.6 \text{ cm}$$

$$A_o = 12.44 \text{ cm}^2$$

Pembacaan def. dial, $\Delta L = 9.00 \text{ mm}$

Pembacaan load dial, $P = 36$

$$\text{Regangan, } \varepsilon = \frac{\Delta L}{L_o} \times 100\% = \frac{9}{36} \times 100\% = 25\%$$

$$\text{Koreksi, } A = \frac{A_o}{(1 - \varepsilon)} = \frac{12.44}{(1 - 0.25)} = 16.587 \text{ cm}^2$$

$$\text{Tegangan deviator, } \Delta\sigma = \frac{PxK}{A} = \frac{36 \times 0.165}{16.587} = 0.265 \text{ kg/cm}^2$$

$$\frac{PxK}{A} = \frac{P_{\max}}{A} = 0.265 \text{ kg/cm}^2$$

Untuk membuat grafik lingkaran Mohr, digunakan $\Delta\sigma_{\max} = 0.265 \text{ kg/cm}^2$

$$\sigma_1 = \sigma_3 + \frac{P_{\max}}{A}$$

$$\sigma_1 = 0.25 + 0.265 = 0.515 \text{ kg/cm}^2$$

$$\text{Jari-jari} = \frac{\sigma_1 - \sigma_3}{2} = \frac{0.515 - 0.25}{2} = 0.257 \text{ kg/cm}^2$$

$$\text{Titik pusat} = \frac{\sigma_1 + \sigma_3}{2} = 0.507 \text{ kg/cm}^2$$

Dengan cara yang sama dibuat lingkaran Mohr untuk $\sigma_3 = 0.5 \text{ kg/cm}^2$ dan $\sigma_3 = 1 \text{ kg/cm}^2$, kemudian ditarik garis linier dan menyinggung masing-masing lingkaran tersebut yang merupakan garis keruntuhan. Dari garis tersebut didapatkan nilai kohesi yang merupakan titik potong garis dengan sumbu - Y dan nilai sudut geser dalam. Dalam grafik lingkaran Mohr digunakan jari-jari lingkaran $= \frac{\sigma_1 - \sigma_3}{2}$, pusat setengah lingkaran sebesar $\frac{\sigma_1 + \sigma_3}{2}$.



Tabel 5.9 Hitungan tegangan pada tanah *undisturb* sampel I

Pengujian ke-	Tek. Deviator $\Delta\sigma = \frac{P_{max}}{A}$ (kg/cm ²)	Tek. Sel σ_3 (kg/cm ²)	Tek. Vertikal $\sigma_1 = \Delta\sigma + \sigma_3$ (kg/cm ²)	$\frac{\sigma_1 + \sigma_3}{2}$ (kg/cm ²)	$\frac{\sigma_1 - \sigma_3}{2}$ (kg/cm ²)
1	0.515	0.25	0.765	0.507	0.257
2	0.638	0.5	1.138	0.819	0.319
3	0.892	1.0	1.892	1.446	0.446

Gambar lingkaran Mohr :

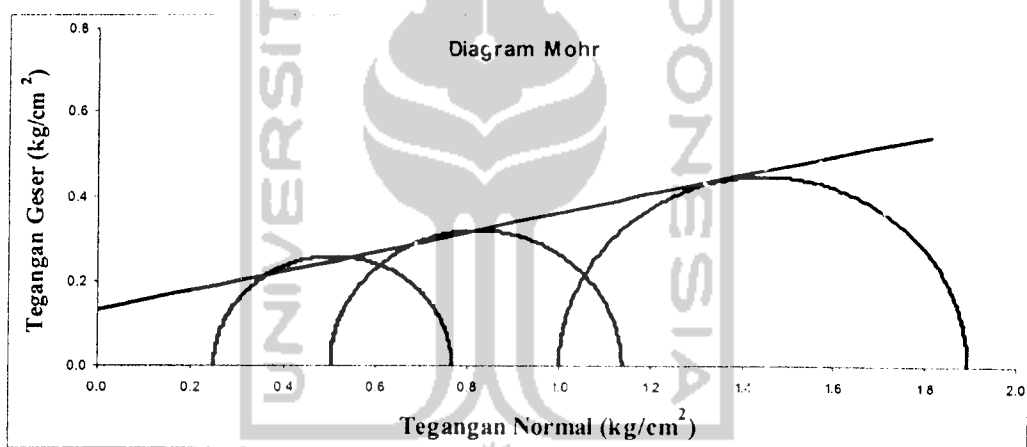
**Gambar 5.7** Grafik Lingkaran Mohr Uji Triaksial Tipe UU Tanah *Undisturb* sampel I**Tabel 5.10** Hitungan tegangan pada tanah *undisturb* sampel II

Pengujian ke-	Tek. Deviator $\Delta\sigma = \frac{P_{max}}{A}$ (kg/cm ²)	Tek. Sel σ_3 (kg/cm ²)	Tek. Vertikal $\sigma_1 = \Delta\sigma + \sigma_3$ (kg/cm ²)	$\frac{\sigma_1 + \sigma_3}{2}$ (kg/cm ²)	$\frac{\sigma_1 - \sigma_3}{2}$ (kg/cm ²)
1	0.494	0.25	0.708	0.479	0.229
2	0.597	0.5	1.097	0.799	0.299
3	0.843	1.0	1.843	1.422	0.422

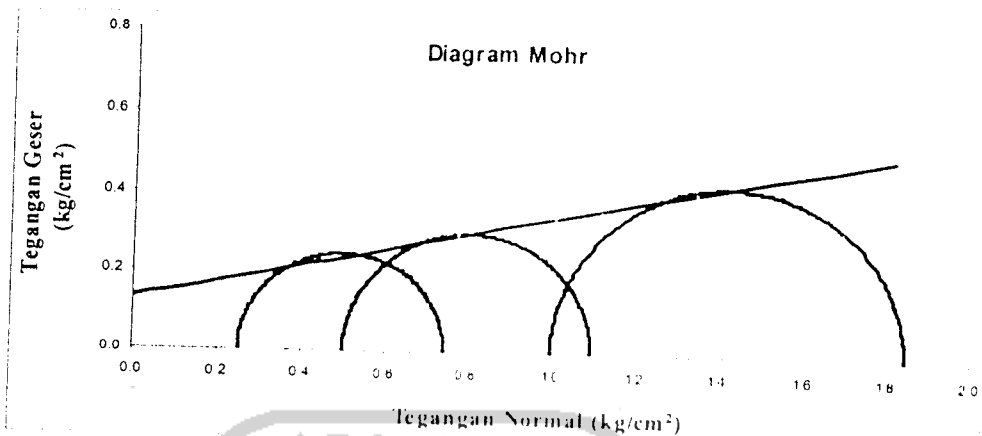

Gambar 5.8 Grafik Lingkaran Mohr Uji Triaksial Tipe UU Tanah *Undisturb* sampel II

Hasil pengujian pada tanah berbutir halus undisturb didapatkan sebagai berikut :

Tabel 5.11 Hasil uji Triaxial UU tanah *undisturb*

Sampel	I	II	Rata-rata
ϕ°	12.68	11.48	12.08
c kg/cm ²	0.13	0.13	0.13

5.1.9 Uji Tekan Bebas

Pengujian kuat tekan bebas dilakukan untuk mendapatkan nilai kuat tekan bebas (q_u) dan sudut geser dalam (ϕ), hasil pengujian pada tanah berbutir halus *undisturbed* didapatkan data seperti pada Tabel 5.11. (Lihat lampiran No. 7)

Contoh perhitungan tegangan sampel tanah *undisturb* :

Pada detik ke-30 pembacaan dial perpendekan tanah 0.40 mm.

$$\text{LRC} = 0.5083 \text{ kg/div}$$

$$\text{Luas } A_o = 11.3411 \text{ cm}^2$$

$$\text{Tinggi } L_o = 7.6 \text{ cm}$$

$$\text{Pembacaan def. dial} = 920$$

$$\text{Pembacaan load dial} = 14.5$$

$$\text{Total deformation, } \Delta L = 920 \times 10^{-2} = 9.2 \text{ mm}$$

$$\text{Total Load, } P = \text{load dial} \times \text{LRC} = 14.5 \times 0.5083 = 7.3704 \text{ kg}$$

$$\text{Regangan, } \varepsilon = \frac{\Delta L}{L_0} = \frac{0.92}{7.6} = 0.1211$$

$$\text{Koreksi, } A = \frac{A_0}{(1-\varepsilon)} = \frac{11.3411}{(1-0.1211)} = 12.9037 \text{ cm}^2$$

$$\text{Tegangan, } \sigma = \frac{P_{\max}}{A} = \frac{7.3704}{12.9037} = 0.5712 \text{ kg/cm}^2$$

Pada pembacaan dial 920 terbaca dial beban 14.5, setara dengan beban 7.3704 kg.

Tegangan, $q_u = \sigma = \frac{P_{\max}}{A} = 0.5712 \text{ kg/cm}^2$ setelah sampel mencapai beban maksimum, dilakukan pengukuran sudut pecah. Dari pembacaan beban maksimum dan sudut pecah dapat dihitung kohesi (c) dan sudut geser dalam (ϕ).

Contoh perhitungan kohesi pada tanah *undisturb* :

$$c = \frac{q_u}{2.1g\alpha} = \frac{0.5712}{2.1g53^\circ} = 0.2152 \text{ kg/cm}^2$$

Contoh perhitungan sudut geser dalam pada tanah *undisturb*:

$$\phi = 2.(\alpha - 45^\circ)$$

$$\phi = 2.(53 - 45^\circ) = 16^\circ$$

Tabel 5.12 Hasil uji Tekan Bebas tanah *undisturb*

Sampel	I	II	Rata-Rata
α°	53	52	52.5
ϕ	16	14	15
q_u (kg/cm ²)	0.5712	0.55996	0.566
c (kg/cm ²)	0.215	0.219	0.217

5.2 Hasil Pengujian Tanah Dicampur Kapur Karbid

5.2.1 Pengujian Triaxial UU Tanah dicampur Kapur Karbid

Hasil pengujian Triaxial tanah dicampur kapur karbid dapat dilihat pada Tabel 5.13, (Lihat Lampiran No. 15 - 20).

Tabel 5.13 Hasil uji Triaxial tanah dicampur kapur karbid

Kadar Kapur Karbid	Curing Time	Sudut geser (ϕ)	c (kg/cm ²)
Tanah Undisturb	-	12.08 ^o	0.13
1.5 %	3 hari	28.37 ^o	0.75
1.5 %	7 hari	26.42 ^o	0.87
1.5 %	14 hari	39.72 ^o	0.64
3 %	3 hari	30.29 ^o	0.81
3 %	7 hari	33.53 ^o	0.85
3 %	14 hari	38.87 ^o	0.69
4.5 %	3 hari	34.24 ^o	0.83
4.5 %	7 hari	38.37 ^o	0.39
4.5 %	14 hari	36.05 ^o	0.94
6 %	3 hari	37.74 ^o	0.57
6 %	7 hari	28.03 ^o	0.72
6 %	14 hari	28.68 ^o	0.96
7.5 %	3 hari	32.81 ^o	0.67
7.5 %	7 hari	35.12 ^o	1.12
7.5 %	14 hari	32.66 ^o	0.63
10 %	3 hari	29.52 ^o	0.80
10 %	7 hari	34.58 ^o	0.44
10 %	14 hari	34.90 ^o	0.85

Perbandingan nilai ϕ pada pengujian Triaksial dengan bahan campuran kapur karbid dapat dilihat pada Gambar 5.9 berikut ini.

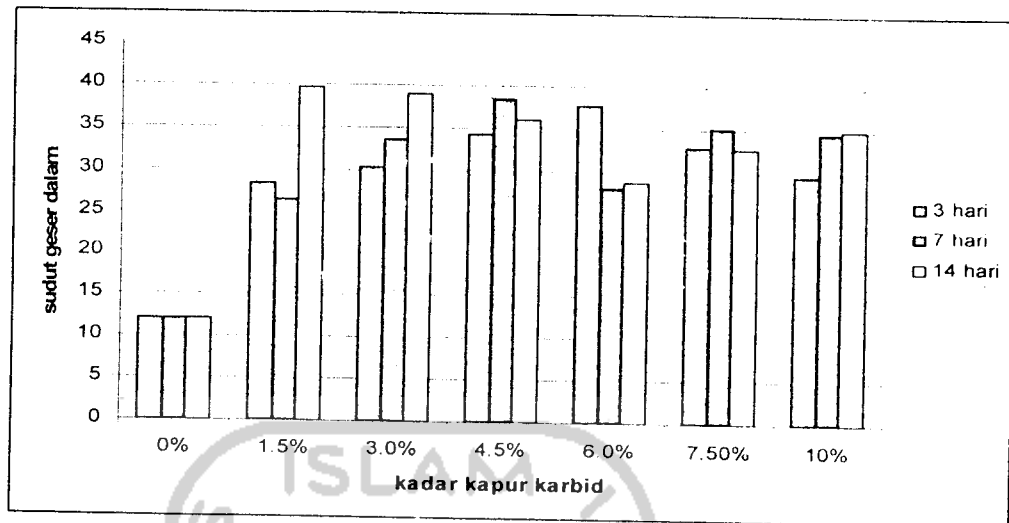

Gambar 5.9 Grafik hubungan antara ϕ dengan Prosentase campuran Kapur karbid pada Uji Triaksial dengan pemeraman 3 hari, 7 hari dan 14 hari

Dari gambar 5.9 diatas dapat dilihat bahwa sudut geser dalam (ϕ) optimum terjadi pada variasi campuran 1.5% pemeraman 14 hari dengan sudut geser dalam (ϕ) sebesar $39,72^\circ$.

Perbandingan nilai Kohesi pada pengujian Triaksial dengan bahan campuran Kapur karbid dapat dilihat pada Gambar 5.10.

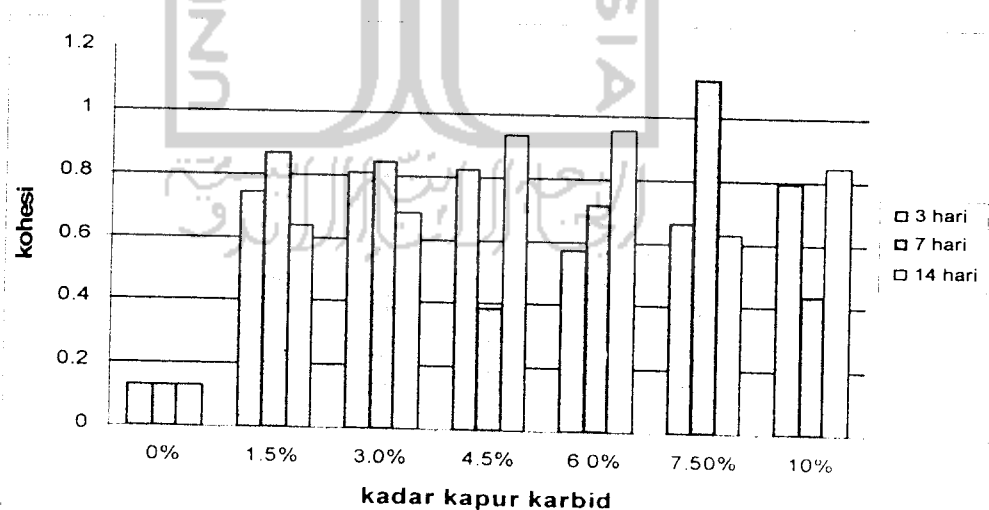

Gambar 5.10 Grafik hubungan antara kohesi dengan prosentase campuran karbid pada uji Triaksial dengan pemeraman 3 hari, 7 hari dan 14 hari

Dari gambar 5.10 diatas dapat dilihat bahwa nilai cohesi (c) optimum terjadi pada variasi campuran 7.5% pemeraman 7 hari dengan nilai cohesi sebesar $1.12 \text{ (kg/cm}^2\text{)}$.

5.2.2 Hasil Pengujian Kuat Tekan Bebas

Pembuatan sampel benda uji dilakukan dengan cetakan berdasarkan kadar air sampel pada pengujian proctor standar. Hasil pengujian kuat tekan bebas pada tanah dicampur karbid dapat dilihat pada Tabel 5.14. (Lihat Lampiran No. 8 - 13)

Tabel 5.14 Hasil uji Tekan Bebas tanah dicampur kapur karbid

Kadar Kapur Karbid	<i>Curing Time</i>	Sudut geser (ϕ) ^o	c (kg/cm ²)
Tanah Undisturb	-	15 ^o	0.217
1.5 %	3 hari	33 ^o	1.017
1.5 %	7 hari	31 ^o	0.837
1.5 %	14 hari	31 ^o	0.734
3 %	3 hari	34.5 ^o	1.015
3 %	7 hari	38.5 ^o	0.946
3 %	14 hari	35 ^o	1.041
4.5 %	3 hari	33.5 ^o	0.629
4.5 %	7 hari	34.5 ^o	0.769
4.5 %	14 hari	39 ^o	1.101
6 %	3 hari	31 ^o	0.625
6 %	7 hari	33 ^o	0.782
6 %	14 hari	39 ^o	0.856
7.5 %	3 hari	31.5 ^o	0.522
7.5 %	7 hari	33.5 ^o	0.787
7.5 %	14 hari	36.5 ^o	0.419
10 %	3 hari	31 ^o	0.584
10 %	7 hari	32.5 ^o	0.558
10 %	14 hari	36 ^o	0.452

Perbandingan nilai ϕ pada pengujian Tekan Bebas dengan bahan campuran kapur karbid dapat dilihat pada Gambar 5.11 berikut ini.

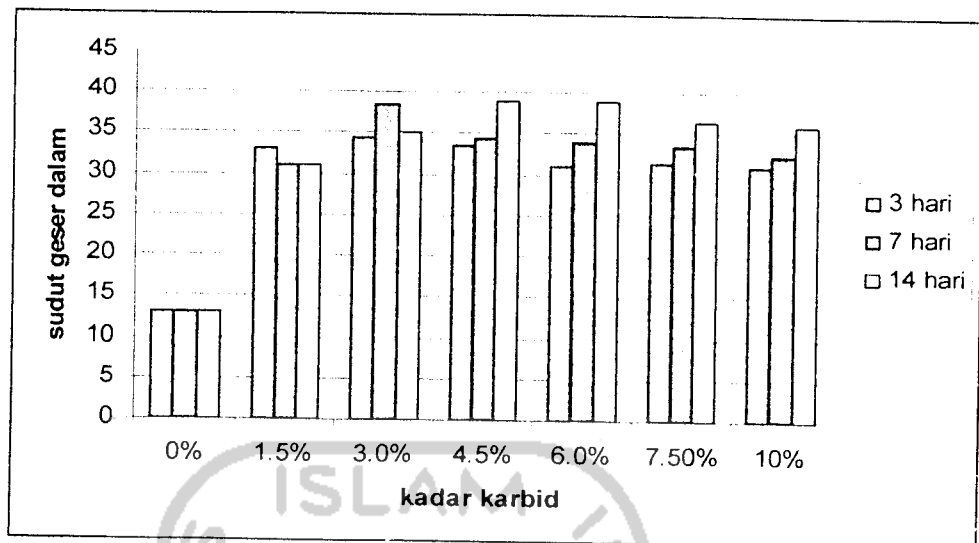

Gambar 5.11 Grafik hubungan antara ϕ dengan Prosentase campuran Kapur karbid pada Uji Tekan Bebas dengan pemeraman 3 hari, 7 hari dan 14 hari

Dari gambar 5.11 diatas dapat dilihat bahwa sudut geser dalam (ϕ) optimum terjadi pada variasi campuran 4.5% dan 6% pemeraman 14 hari dengan sudut geser dalam (ϕ) sebesar 39° .

Perbandingan nilai Kohesi pada pengujian Tekan Bebas dengan bahan campuran Kapur karbid dapat dilihat pada Gambar 5.12 dibawah ini :

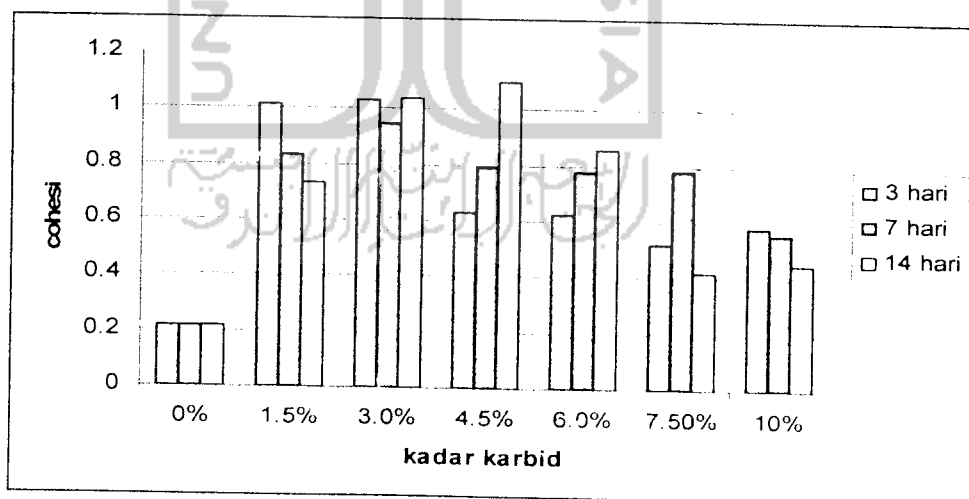

Gambar 5.12 Grafik hubungan antara kohesi dengan prosentase campuran karbid pada uji Tekan Bebas dengan pemeraman 3 hari, 7 hari dan 14 hari

Dari gambar 5.12 diatas dapat dilihat bahwa nilai kohesi (c) optimum terjadi pada variasi campuran 4.5% pemeraman 14 hari dengan nilai kohesi sebesar $1.101 \text{ (kg/cm}^2\text{)}$.

BAB VI PEMBAHASAN

6.1. Klasifikasi Tanah

Berdasarkan data hasil pengujian sifat fisik dan mekanik tanah yang digunakan dalam penelitian ini dapat ditentukan karakteristik tanah dengan sistem klasifikasi tanah *Unified Soil Classification System (USCS)* dan sistem Klasifikasi AASHTO.

6.1.1 Sistem Klasifikasi Tanah USCS

1. Tanah yang lolos saringan no.200 adalah sebesar 77.15%. Prosentase ini lebih besar dari 50%, maka termasuk golongan berbutir halus.

Tabel 6.1. Grain Size Analysis Average

Finer	77.15%
Gravel	0,00%
Sand	22.85%
Silt	36.504%
Clay	40.546%

2. Batas cair sebesar 49.975% kurang dari 50% dengan plastisitas indeks 14.43%, maka tanah ini termasuk kelompok OL dengan nama lanau organik dan lempung berlanau organik dengan plastisitas sedang berdasarkan sistem Klasifikasi Tanah Unified seperti pada grafik Unified yang didapatkan dari titik pertemuan yang diplotkan antara batas cair dengan indeks plastisitasnya, seperti tampak pada gambar 6.1 berikut :

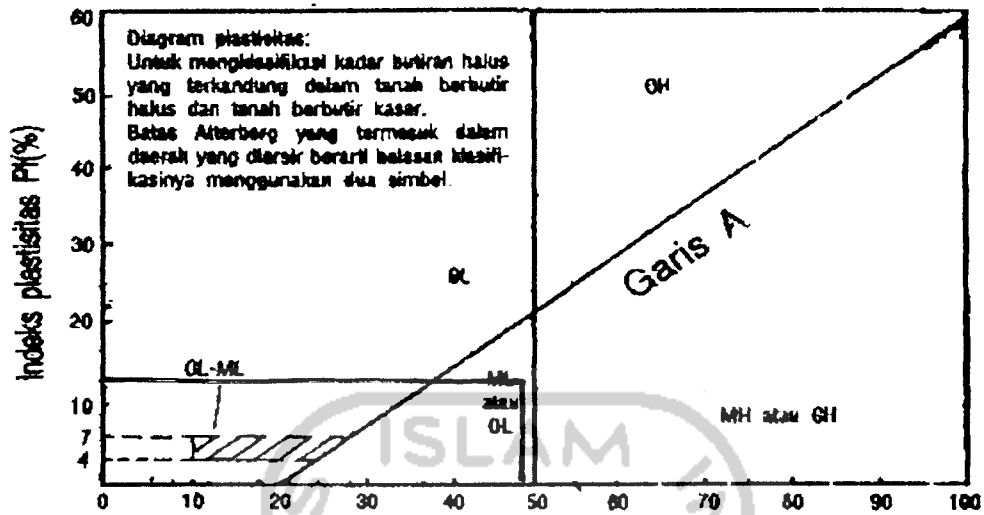

Gambar 6.1. Grafik Sistem Klasifikasi Tanah Unified

3. Berdasarkan Grain size Analysis didapat kandungan pasir sebesar 22.85%, lanau sebesar 36.604%, dan lempung sebesar 40.546%. Maka menurut USCS tanah ini digolongkan dalam lempung berlanau (*Silty Clay*).

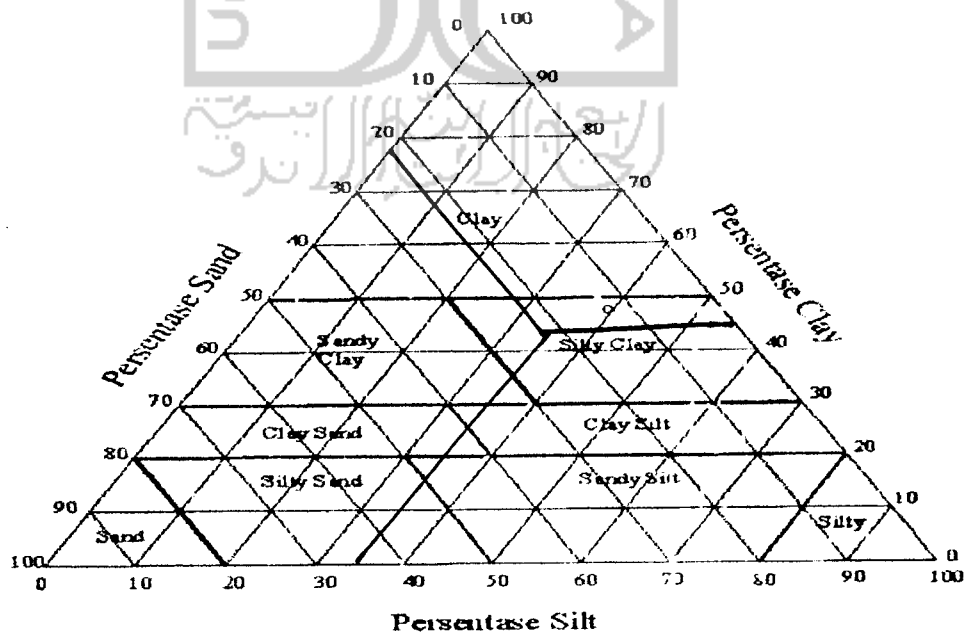

Gambar 6.2 Grafik segitiga Klasifikasi Tanah

6.1.2 Sistem Klasifikasi AASHTO

Pengujian yang digunakan hanya analisis saringan dan batas-batas Atterberg, maka diperoleh data sebagai berikut.

1. % lolos saringan no. 200 > 35 %, ditunjukkan dengan penjumlahan lempung 40.41 % dan lanau 36.74 % menjadi 77.15 %, maka termasuk jenis lanau atau lempung.
2. Batas Cair (LL) = 49.975 %
3. Indeks Plastis (IP) = 14.43 %
4. Batas Plastis (PL) = 35.545 % > 30 %
5. Indeks kelompok (GI) = $(F - 35)[0.2 + 0.005(LL - 40)] + 0.01(F - 15)(PI - 10)$
 $GI = (77.15 - 35)[0.2 + 0.005(49.975 - 40)] + 0.01(77.15 - 15)(14.43 - 10)$
 $GI = 14$ (dibulatkan)

Dari hasil data diatas berdasarkan Tabel 3.1 sistem klasifikasi AASHTO maka tanah Pekalongan, Jawa Tengah dapat dikelompokkan dalam kelompok A-7-5 (14) yang menunjukkan tipe material pada umumnya merupakan tanah berlempung.

6.2 Pengaruh Pencampuran Karbid terhadap Tanah Berbutir Halus

Semakin banyak karbid yang dicampur dengan tanah, kohesi (c) dan sudut geser dalam (ϕ) cenderung mengalami penurunan. Pada kadar Karbid 4.5% pemeraman 14 hari nilai sudut geser dalam (ϕ) dan cohesi (c) mencapai nilai yang maksimum.

6.2.1 Analisis Kuat Dukung Tanah teori Vesic

Dengan menggunakan rumus persamaan fondasi Vesic yaitu :

$$q_u = s_c \cdot d_c \cdot i_c \cdot b_c \cdot g_c \cdot c \cdot N_c + s_q \cdot d_q \cdot i_q \cdot b_q \cdot g_q \cdot p_o \cdot N_q + s_\gamma \cdot d_\gamma \cdot i_\gamma \cdot b_\gamma \cdot g_\gamma \cdot 0,5 \cdot B \cdot \gamma \cdot N_\gamma \quad (6.1)$$

dengan :

- q_u = kapasitas dukung ultimit (T/m^2)
- γ = berat volume tanah (T/m^3)
- c = kohesi tanah (T/m^2)
- p_o = $D_f \gamma$ = tekanan overburden di dasar fondasi (T/m^2)

- s_c, s_q, s_γ = faktor-faktor bentuk fondasi (tabel 3.6)
 d_c, d_q, d_γ = faktor-faktor kedalaman fondasi (tabel 3.7)
 i_c, i_q, i_γ = faktor-faktor kemiringan beban (tabel 3.8)
 b_c, b_q, b_γ = faktor-faktor kemiringan dasar (tabel 3.9)
 g_c, g_q, g_γ = faktor-faktor kemiringan permukaan (tabel 3.10)
 N_c, N_q, N_γ = faktor-faktor kapasitas dukung Vesic (tabel 3.11)

6.2.2 Analisis Kuat Dukung Tanah *Undisturb* dengan metode Vesic

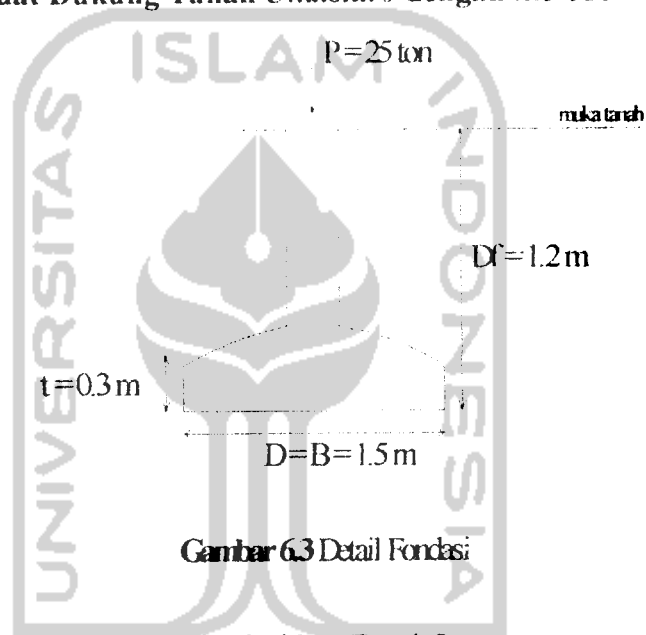

Gambar 6.3 Detail Fondasi

Dengan asumsi diameter fondasi $D = B = 1.5 \text{ m}$
 Beban dianggap vertikal sentris dengan momen = 0
 $D_f = 1.2 \text{ m}$, $SF = 2.5$

$$t = 30 \text{ cm} = 0.3 \text{ m}$$

$$\gamma = \gamma_b = 1.75 \text{ gr/cm}^3 = 1.75 \text{ t/m}^3 \text{ dan } \gamma_{\text{beton}} = 2.5 \text{ t/m}^3$$

$$P_o = (D_f - t) \cdot \gamma_b + t \times \gamma_{\text{beton}} = (1.2 - 0.3) \times 1.75 + 0.3 \times 2.5 = 2.325 \text{ t/m}^2$$

- Dari hasil pengujian Tekan Bebas di dapat nilai :

$$\text{Kohesi (c)} = 0.217 \text{ kg/cm}^2 = 2.17 \text{ t/m}^2$$

$$\text{Sudut geser dalam } (\varphi) = 15^\circ$$

$$\text{dari Tabel 3.9 diperoleh } \rightarrow N_c = 10.98$$

$$N_q = 3.94$$

$$N_\gamma = 2.65$$

- faktor bentuk pondasi Vesic $\rightarrow S_c = 1 + \frac{Nq}{Nc} = 1 + \frac{3.94}{10.98} = 1.36$
 $S_q = 1 + \text{tg } \varphi = 1 + \text{tg } 15^\circ = 1.27$
 $S_\gamma = 0.6$

- faktor kedalaman pondasi Vesic $\rightarrow d_c = 1 + 0.4 \left(\frac{Df}{B} \right)$
 $= 1 + 0.4 \left(\frac{1.2}{1.5} \right)$
 $= 1.192$

$$d_q = 1 + 2 \left(\frac{Df}{B} \right) \text{tg } \varphi (1 - \sin \varphi)^2$$

$$= 1 + 2 \left(\frac{1.2}{1.5} \right) \text{tg } 15^\circ (1 - \sin 15^\circ)^2$$

$$= 1.141$$

$$d_\gamma = 1$$

- faktor kemiringan beban Vesic $\rightarrow i_c = i_q = i_\gamma = 1$
- faktor kemiringan dasar pondasi Vesic $\rightarrow b_c = b_q = b_\gamma = 1$
- faktor kemiringan permukaan Vesic $\rightarrow g_c = g_q = g_\gamma = 1$

$$\begin{aligned} \diamond q_u &= s_c \cdot d_c \cdot i_c \cdot b_c \cdot g_c \cdot c \cdot N_c + s_q \cdot d_q \cdot i_q \cdot b_q \cdot g_q \cdot p_o \cdot N_q + s_\gamma \cdot d_\gamma \cdot i_\gamma \cdot b_\gamma \cdot g_\gamma \cdot 0.5 \cdot B \cdot \gamma \cdot N_\gamma \\ &= (1.36 \times 1.192 \times 1 \times 1 \times 1 \times 2.17 \times 10.98) + \\ &\quad (1.27 \times 1.141 \times 1 \times 1 \times 1 \times 2.325 \times 3.94) + \\ &\quad (0.6 \times 1 \times 1 \times 1 \times 1 \times 0.5 \times 1.5 \times 1.75 \times 2.65) \\ &= 59.174 \text{ t/m}^2 \end{aligned}$$

$$\diamond q_a = \frac{q_u}{SF} = \frac{59.174}{2.5} = 23.67 \text{ t/m}^2$$

$$\begin{aligned} \diamond q_n &= q_a - p_o \\ &= 23.67 - 2.325 = 21.345 \text{ t/m}^2 \end{aligned}$$

$$\text{Cek } B = D \rightarrow q_n = \frac{P}{A} = \frac{4P}{3.14B^2}$$

$$B = \sqrt{\frac{4P}{3.14q_n}} = \sqrt{\frac{100}{3.14 \times 21.345}} = 1.221 \text{ m} < B_{\text{prediksi}} = 1.5 \text{ m}$$

ambil $B = 1.5 \text{ m}$

$$\begin{aligned} \text{➤ } P_{\text{total}} &= P + \{(0.25 \times 3.14 \times B^2 \cdot (Df - t) \cdot \gamma_{\text{tanah}}) + (0.25 \times 3.14 \times B^2 \cdot t \cdot \gamma_{\text{beton}})\} \\ &= 25 + \{(0.25 \times 3.14 \times 1.5^2 \times (1.2 - 0.3) \times 1.75) + (0.25 \times 3.14 \times 1.5^2 \times 0.3 \times 2.5)\} \\ &= 29.107 \text{ ton} \end{aligned}$$

$$\text{➤ } q_{\text{terjadi}} = \frac{4 \times 29.107}{3.14 \times 1.5^2} = 16.43 \text{ t/m}^2 < q_a = 23.67 \text{ t/m}^2 \rightarrow \text{OK!!}$$

6.2.3 Analisis Kuat Dukung Tanah yang dicampur karbid variasi 4.5% pada pemeraman 14 hari dengan teori Vesic

Dengan asumsi diameter $D = B_{\text{prediksi}} = 1.5 \text{ m}$

- Dari hasil pengujian Tekan Bebas di dapat nilai :

$$\text{Kohesi (c)} = 1.101 \text{ kg/cm}^2 = 11.01 \text{ t/m}^2$$

$$\text{Sudut geser dalam } (\phi) = 39^\circ$$

$$\text{dari Tabel 3.8 diperoleh } \rightarrow N_c = 67.87$$

$$N_q = 55.96$$

$$N_\gamma = 92.25$$

- faktor bentuk pondasi Vesic $\rightarrow S_c = 1 + \frac{Nq}{Nc} = 1 + \frac{55.96}{67.87} = 1.82$
 $S_q = 1 + \text{tg } \phi = 1 + \text{tg } 39^\circ = 1.81$
 $S_\gamma = 0.6$

- faktor kedalaman pondasi Vesic $\rightarrow d_c = 1 + 0.4 \left(\frac{Df}{B} \right)$
 $= 1 + 0.4 \left(\frac{1.2}{1.5} \right)$
 $= 1.32$

$$d_q = 1 + 2 \left(\frac{Df}{B} \right) \text{tg } \phi (1 - \sin \phi)^2$$

$$= 1 + 2 \left(\frac{1.20}{1.5} \right) \tan 39^\circ (1 - \sin 39^\circ)^2$$

$$= 1.178$$

$$d_\gamma = 1$$

- faktor kemiringan beban Vesic $\rightarrow i_c = i_q = i_\gamma = 1$
- faktor kemiringan dasar pondasi Vesic $\rightarrow b_c = b_q = b_\gamma = 1$
- faktor kemiringan permukaan Vesic $\rightarrow g_c = g_q = g_\gamma = 1$

$$\begin{aligned} \diamond q_u &= s_c \cdot d_c \cdot i_c \cdot b_c \cdot g_c \cdot c \cdot N_c + s_q \cdot d_q \cdot i_q \cdot b_q \cdot g_q \cdot p_o \cdot N_q + s_\gamma \cdot d_\gamma \cdot i_\gamma \cdot b_\gamma \cdot g_\gamma \cdot 0.5 \cdot B \cdot \gamma \cdot N_\gamma \\ &= (1.82 \times 1.32 \times 1 \times 1 \times 1 \times 11.01 \times 67.87) + \\ &\quad (1.81 \times 1.178 \times 1 \times 1 \times 1 \times 1 \times 2.361 \times 55.96) + \\ &\quad (0.6 \times 1 \times 1 \times 1 \times 1 \times 0.5 \times 1.5 \times 1.79 \times 92.25) \end{aligned}$$

$$= 2154.816 \text{ t/m}^2$$

$$\diamond q_a = \frac{q_u}{SF} = \frac{2154.816}{2.5} = 861.926 \text{ t/m}^2$$

$$\begin{aligned} \diamond q_n &= q_a - p_o \\ &= 861.926 - 2.361 = 859.565 \text{ t/m}^2 \end{aligned}$$

$$\text{Cek B} \rightarrow q_n = \frac{P}{A} = \frac{4P}{3.14B^2}$$

$$B = \sqrt{\frac{4P}{3.14q_n}} = \sqrt{\frac{100}{3.14 \times 859.565}} = 0.192 \text{ m} < B_{\text{prediksi}} = 1.5 \text{ m}$$

ambil B = 1 m

$$\begin{aligned} \triangleright P_{\text{total}} &= P + \{(0.25 \times 3.14 \times B^2 \cdot (Df - t) \cdot \gamma_{\text{tanah}}) + (0.25 \times 3.14 \times B^2 \cdot t \cdot \gamma_{\text{beton}})\} \\ &= 25 + \{(0.785 \times (1.2 - 0.3) \times 1.79) + (0.785 \times 0.3 \times 2.5)\} \\ &= 26.853 \text{ ton} \end{aligned}$$

$$\triangleright q_{\text{terjadi}} = \frac{4 \times 26.853}{3.14 \times 1^2} = 34.208 \text{ t/m}^2 < q_a = 861.926 \text{ t/m}^2 \rightarrow \text{OK!!}$$

Untuk hasil keseluruhan perhitungan kuat dukung tanah dengan bahan campuran kapur karbid untuk pemeraman 3 hari, 7 hari, 14 hari berdasarkan uji Tekan Bebas dan Triaxial dapat dilihat pada Tabel 6.1 dan Tabel 6.2.

Tabel 6.1 Perhitungan kuat dukung dan lebar pondasi dengan campuran kapur karbid pada pengujian Tekan Bebas

Pemeraman (hari)	Karbid (%)	Df (m)	y _b (t/m ³)	po (t/m ²)	B (m)	c	φ	qu (t/m ²)	B _{baru} (m)	qu _{baru} (t/m ²)	q _a (t/m ²)	Q _{terjadi} (t/m ²)	B _{ambit} (m)	Q _{terjadi} (t/m ²)	A = 0.25XTX B ²	Luasan pondasi(%)
Tanah asli	1.5	1.2	1.75	2.325	1.5	2.17	15	59.174	1.5	59.174	23.67	16.48	1.5	16.48	1.77	0
		1.2	1.92	2.478	1.5	10.17	33	1028.976	0.3	1028.976	401.86	356.34	1	34.325	0.785	55.65
		1.2	1.82	2.388	1.5	10.33	34.5	1218.638	0.3	1189.449	475.78	356.25	1	34.235	0.785	55.65
		1.2	1.8	2.37	1.5	6.29	33.5	729.514	0.4	706.868	282.75	201.41	1	34.217	0.785	55.65
		1.2	1.75	2.325	1.5	6.25	31	554.338	0.4	539.329	215.73	201.37	1	34.172	0.785	55.65
		1.2	1.715	2.3	1.5	5.215	31.5	506.272	0.5	491.815	196.73	129.68	1	34.141	0.785	55.65
		1.2	1.725	2.31	1.5	5.84	31	524.289	0.5	510.839	204.34	129.69	1	34.15	0.785	55.65
		1.2	1.74	2.316	1.5	8.37	31	703.012	0.4	688.08	275.24	201.36	1	34.163	0.785	55.65
		1.2	1.77	2.343	1.5	9.46	38.5	1790.13	0.3	1735.882	694.35	356.2	1	34.19	0.785	55.65
		1.2	1.75	2.325	1.5	7.95	34.5	975.985	0.3	947.922	379.17	356.18	1	34.172	0.785	55.65
7		1.2	1.74	2.316	1.5	7.82	33	816.86	0.4	796.654	318.66	201.36	1	34.163	0.785	55.65
		1.2	1.745	2.32	1.5	7.87	33.5	867.901	0.4	845.946	338.38	201.37	1	34.168	0.785	55.65
		1.2	1.75	2.307	1.5	5.58	32.5	593.258	0.4	574.589	229.84	201.35	1	34.154	0.785	55.65
		1.2	1.73	2.307	1.5	7.4	31	629.712	0.4	614.874	245.95	201.35	1	34.154	0.785	55.65
		1.2	1.76	2.334	1.5	10.4	35	1287.906	0.3	1257.474	502.99	356.19	1	34.181	0.785	55.65
		1.2	1.79	2.361	1.5	11.01	39	2154.816	0.3	2095.37	838.15	356.22	1	34.208	0.785	55.65
		1.2	1.77	2.343	1.5	10.86	39	2128.137	0.3	2069.356	827.74	356.2	1	34.19	0.785	55.65
		1.2	1.7	2.28	1.5	4.19	36.5	754.796	0.4	720.435	288.17	201.32	1	34.127	0.785	55.65
		1.2	1.69	2.271	1.5	4.52	36	747.15	0.4	715.746	286.3	201.32	1	34.118	0.785	55.65
		1.2	1.69	2.271	1.5	4.52	36	747.15	0.4	715.746	286.3	201.32	1	34.118	0.785	55.65

Keterangan :

Dengan mengambil diameter pondasi minimum (B) = 1 m

Luasan pondasi $A = 0.25 \times \pi \times B^2$

Tabel 6.2 Perhitungan kuat dukung dan lebar pondasi dengan campuran kapur karbid pada pengujian Triaxial

Pemeraman (hari)	Karbid (%)	Df (m)	γ_b (t/m^3)	p_o (t/m^2)	B (m)	c	ϕ	q_u (t/m^2)	B_{baru} (m)	q_u baru (t/m^2)	q_a (t/m^2)	q terjadi (t/m^2)	B_{ambit} (m)	q terjadi (t/m^2)	A = $0.25 \times \pi \times B^2$	Luasan pondasi (%)	
Tanah asli		1.2	1.737	2.3133	2	1.3	12.08	31.997	2	31.997	12.8	10.28	2	10.28	3.14	0	
3	1.5	1.2	1.633	2.2197	2	7.5	28.37	463.999	0.5	451	180.4	129.61	1	34.07	0.785	75	
	3	1.2	1.633	2.2197	2	8.1	30.29	605.139	0.4	587.072	234.83	201.26	1	34.07	0.785	75	
	4.5	1.2	1.633	2.2197	2	8.3	34.24	940.55	0.4	906.162	362.46	201.26	1	34.07	0.785	75	
	6	1.2	1.633	2.2197	2	5.7	37.74	1038.787	0.3	976.616	390.65	356.08	1	34.07	0.785	75	
	7.5	1.2	1.634	2.2206	2	6.7	32.81	657.029	0.4	630.385	252.15	201.27	1	34.07	0.785	75	
	10	1.2	1.637	2.2233	2	8	29.52	556.004	0.4	539.456	215.78	201.27	1	34.07	0.785	75	
	1.5	1.2	1.643	2.2287	2	8.7	26.42	443.215	0.5	433.345	173.34	129.62	1	34.08	0.785	75	
	3	1.2	1.627	2.2143	2	8.5	33.53	880.025	0.4	849.81	339.92	201.26	1	34.06	0.785	75	
	4.5	1.2	1.661	2.2449	2	3.9	38.37	879.66	0.4	811.995	324.8	201.29	1	34.09	0.785	75	
	6	1.2	1.64	2.226	2	7.2	28.03	441.771	0.5	429.24	171.7	129.61	1	34.07	0.785	75	
7	7.5	1.2	1.623	2.2107	2	11.2	35.12	1317.252	0.3	1276.727	510.69	356.07	1	34.06	0.785	75	
	10	1.2	1.632	2.2188	2	4.4	34.58	600.004	0.4	565.05	226.02	201.26	1	34.07	0.785	75	
	1.5	1.2	1.632	2.2188	2	6.4	39.72	1473.507	0.3	1384.557	553.82	279.52	1	26.742	0.785	75	
	3	1.2	1.688	2.2692	2	6.9	38.37	1367.615	0.3	1289.921	515.97	279.56	1	26.781	0.785	75	
	4.5	1.2	1.687	2.2683	2	9.4	36.05	1278.955	0.3	1229.071	491.63	279.56	1	26.781	0.785	75	
	6	1.2	1.653	2.2377	2	9.6	28.68	594.075	0.4	579.245	231.7	158.01	1	26.757	0.785	75	
	7.5	1.2	1.663	2.2467	2	6.3	32.66	632.696	0.4	606.37	242.55	158.01	1	26.764	0.785	75	
	10	1.2	1.682	2.2638	2	8.5	34.9	1017.12	0.3	976.166	390.47	279.55	1	26.777	0.785	75	
	14	1.5	1.2	1.632	2.2188	2	6.4	39.72	1473.507	0.3	1384.557	553.82	279.52	1	26.742	0.785	75
		3	1.2	1.688	2.2692	2	6.9	38.37	1367.615	0.3	1289.921	515.97	279.56	1	26.781	0.785	75
4.5		1.2	1.687	2.2683	2	9.4	36.05	1278.955	0.3	1229.071	491.63	279.56	1	26.781	0.785	75	
6		1.2	1.653	2.2377	2	9.6	28.68	594.075	0.4	579.245	231.7	158.01	1	26.757	0.785	75	
7.5		1.2	1.663	2.2467	2	6.3	32.66	632.696	0.4	606.37	242.55	158.01	1	26.764	0.785	75	
10		1.2	1.682	2.2638	2	8.5	34.9	1017.12	0.3	976.166	390.47	279.55	1	26.777	0.785	75	

Keterangan :

Dengan mengambil diameter pondasi minimum (B) = 1 m

Luasan pondasi A = $0.25 \times \pi \times B^2$

Dari Tabel 6.1 dapat dilihat, kuat dukung tanah (q_u) meningkat pada persentase tertentu dan terjadi penurunan pada penambahan dengan variasi maksimum. Kuat dukung tanah maksimum terjadi pada saat variasi 4.5 % dengan pemeraman 14 hari yaitu sebesar 2154.816 t/m^2 dari 59.174 t/m^2 kuat dukung tanah asli, sedangkan untuk lebar pondasi pada Tabel 6.1 dapat dilihat terjadi kesamaan ukuran untuk pencampuran kapur karbid 1.5% - 10% untuk semua pemeraman 3 hari, 7 hari, dan 14 hari karena untuk lebar pondasi diambil minimum sebesar 1 meter. Bila perbandingan luasan pondasi diambil berdasarkan kuat dukung tanah optimalnya, maka perbandingan luasan pondasi antara tanah yang dicampur kapur karbid 4.5 % dengan pemeraman 14 hari dan tanah aslinya yaitu sebesar 1 m^2 dari 1.77 m^2 atau terjadi pengurangan sebesar 55.65 %.

Dari Tabel 6.2 perhitungan kuat dukung tanah uji Triaxial dapat dilihat, kuat dukung tanah (q_u) maksimum terjadi pada saat variasi kapur karbid 1.5 % dengan pemeraman 14 hari yaitu sebesar 1473.507 t/m^2 dari 31.997 t/m^2 kuat dukung tanah asli., sedangkan untuk lebar pondasi pada Tabel 6.2 dapat dilihat perbandingan luasan pondasi antara tanah yang dicampur kapur karbid 1.5 % dengan pemeraman 14 hari dan tanah aslinya yaitu sebesar 1 m^2 dari 3.14 m^2 atau terjadi pengurangan sebesar 75 %.

Dari hasil analisis pada perhitungan Tabel-tabel diatas menunjukkan bahwa berat volume (γ) berpengaruh sedikit dalam perencanaan fondasi, sedangkan nilai kohesi (c) dan sudut geser dalam (ϕ) paling dominan pada perencanaan fondasi. Dari perhitungan kuat dukung tanah, setelah dicampur dengan bahan aditif kapur karbid didapatkan dimensi pondasi dengan diameter 1 m lebih kecil daripada diameter tanah asli sebesar 1.5 m.

BAB VII KESIMPULAN DAN SARAN

Bab ini akan membahas karakteristik lempung dari Cepagan, Pekalongan, Jawa Tengah berdasarkan hasil penelitian Laboratorium. Pengujian Triaksial UU dan Uji Tekan Bebas dilaksanakan dengan variasi 1.5%, 3%, 4.5%, 6%, 7.5%, 10% pada bahan tambah kapur karbid dengan waktu pemeraman 3 hari, 7 hari, dan 14 hari. Beberapa kesimpulan dan saran akan disampaikan dan dikemukakan untuk kesinambungan penelitian.

7.1 Kesimpulan

Beberapa kesimpulan yang dapat disampaikan dari hasil penelitian adalah sebagai berikut ini.

1. Berdasarkan sifat fisiknya, tanah lempung yang berasal dari Cepagan, Pekalongan, Jawa Tengah berwarna merah kecoklatan, lengket, dan mengandung pasir.
Berdasarkan sistem klasifikasi "segitiga" USCS, termasuk tanah lempung kelanauan (*silty clay*) sedangkan pada sistem klasifikasi *Unified* termasuk dalam golongan OL dengan nama lanau organik dan lempung berlanau organik dengan plastisitas sedang.
2. Pengaruh penambahan kapur karbid terhadap c dan ϕ menunjukkan kecenderungan meningkat pada variasi antara 1.5 % - 4.5 % dan terjadi penurunan pada variasi 6 % - 10 %.
3. Kuat dukung tanah maksimum pada uji Tekan Bebas terjadi pada pencampuran 4.5 % kapur karbid dengan pemeraman 14 hari sebesar 2154.816 t m^2 dengan kohesi (c) 11.01 t m^2 dan sudut geser dalam sebesar 39° , sedangkan untuk uji Triaxial terjadi pada pencampuran 1.5 % kapur karbid dengan pemeraman 14 hari sebesar 1473.507 t m^2 dengan sudut geser dalam sebesar 39.72° serta kohesi (c) 6.4 t m^2 . Peningkatan nilai sudut geser

dalam (ϕ) dan kohesi (c) menyebabkan kenaikan nilai kuat dukung tanah (q_u) sehingga dapat menghemat dimensi fondasi sebesar 75 %.

7.2 Saran

Dari hasil penelitian yang telah dilakukan, beberapa saran yang dapat disampaikan adalah sebagai berikut ini.

1. Dalam pelaksanaan pengujian di Laboratorium diperlukan ketelitian dalam pencampuran tanah lempung dengan bahan tambah dalam hal ini kapur karbid, karena akan sangat berpengaruh terhadap hasil pengujian.
2. Perlu kecermatan pada saat penulisan pembacaan dial beban pada uji Triaxial, sebab jarum petunjuk pembacaan dial bergerak cepat pada saat pengujian sehingga perlu pengawasan yang lebih baik.
3. Pada persiapan sampel untuk tanah berbutir halus Pekalongan disaring dengan menggunakan saringan yang mendekati ukuran fraksi tanah lempung (No.200, $\phi = 0,075$ mm) sehingga pada penambahan kadar air, tanah dapat dianggap homogen.

DAFTAR PUSTAKA

- Ade Rahardian, 2004, **Stabilisasi Tanah Lempung Dengan Bahan Tambah Kapur Karbid Dan Abu Sekam**, Tugas Akhir Mahasiswa S1 JTS FTSP-UH.
- Braja M. Das, 1988, Mekanika Tanah (Prinsip-Prinsip Rekayasa Geoteknis) Jilid I, Erlangga, Jakarta.
- Braja M. Das, 1994, Mekanika Tanah (Prinsip-Prinsip Rekayasa Geoteknis) Jilid II, Erlangga, Jakarta.
- Craig , R. F, 1989, Mekanika Tanah, Erlangga, Jakarta.
- Faratodi Syailendra dan M. Ali Faisal, 2005, **Pengaruh Penambahan Serbuk Arang Dan Kapur Karbid Pada Tanah Berbutir Halus Terhadap Parameter Kuat Geser Tanah** , Tugas Akhir Mahasiswa S1 JTS FTSP-UH.
- Hary C. Hardiyatmo, 1955, Mekanika tanah 1, Gramedia Pustaka Utama, Jakarta.
- Hary C. Hardiyatmo, 2002, Teknik Pondasi 1 dan Teknik Pondasi 2, Beta Offset, Yogyakarta.
- Irving S. Dunn, Loren R. Anderson, dan Fred W. Kiefer, 1992, Dasar-dasar Analisis Geoteknik, IKIP Semarang Press, Semarang.
- Joseph E. Bowles, 1986, Sifat-sifat Fisis dan Geoteknis Tanah, Erlangga, Jakarta.
- Joseph E. Bowles, 1991, Analisis dan Desain Pondasi, Erlangga, Jakarta.

Suyono, Sosrodarsono dan Kazuto Nakazawa, 1990, Mekanika Tanah dan Teknik Pondasi, PT. PERTJA, Jakarta.

Wesley, L. D, 1977, Mekanika Tanah, Badan Penerbit Pekerjaan Umum, Jakarta.

_____, 2001, PANDUAN PRAKTIKUM MEKANIKA TANAH, Universitas Islam Indonesia, Yogyakarta.

_____, BUKU PEDOMAN TUGAS AKHIR DAN PRAKTIK KERJA, Universitas Islam Indonesia, Yogyakarta.



KARTU PESERTA TUGAS AKHIR

D	N A M A	NO.MHS.	BID.STUDI
	Purwadi	01 511 331	Teknik Sipil

JUDUL TUGAS AKHIR

Analisis Pengaruh Pencampuran Bahan Aditif Kapur Pada Tanah Butir Halus di bawah Dasar Pondasi bangunan Terhadap Dimensi Pondasi Dengan Metode Vesic

PERIODE KE	: IV (Juni 06- Nop.06)
TAHUN	: 2005 - 2006
Sampai Akhir Nopember 2006	

o.	Kegiatan	Bulan Ke :					
		JUN.	JUL.	AGT.	SEP.	OKT.	NOV.
1	Pendaftaran						
2	Penentuan Dosen Pembimbing						
3	Pembuatan Proposal						
4	Seminar Proposal						
5	Konsultasi Penyusunan TA.						
6	Sidang - Sidang						
7	Pendadaran						

Dosen Pembimbing I : Ibnu Sudarmadji, Ir, H, MS
 Dosen Pembimbing II : Ibnu Sudarmadji, Ir, H, MS



Jogjakarta ,24-Jun-06
 a.n. Dekan



Ibnu Sudarmadji, Ir, H, MS

Catatan	:	
Seminar	:	18/06
Sidang	:	
Pendadaran	:	24/6 '06

CATATAN KONSULTASI TUGAS AKHIR

NO	TANGGAL	CATATAN KONSULTASI	TANGGAL
1	2/8/06	Sabtu 75 diberi tanda	2/8/06
2	7/8/06	Diciptakan dan dinilai	7/8/06
3	16/10/06	Ditambah dengan nilai 20 Feb 07 / 1000 nama mahasiswa	16/10/06
4	9/2/07	Sabtu 75 diberi tanda Kegiatan: 1.05 pengujian 2.05 200 3.05 Tabel 4.05 1000 5.05 1000 6.05 1000	9/2/07
5	14/2/07	Kegiatan: 1.05 pengujian 2.05 200 3.05 Tabel 4.05 1000 5.05 1000 6.05 1000 7.05 1000 8.05 1000 9.05 1000 10.05 1000 11.05 1000 12.05 1000	14/2/07
6	04/07	A ce dt misja ke 1000	04/07
7	26/4	A ce dt dipilih dulu	26/4



LAMPIRAN 1
Pengujian Kadar Air Tanah



LABORATORIUM MEKANIKA TANAH
FAKULTAS TEKNIK SIPIL DAN PERENCANAAN UII

Jln. Kaliurang KM 14,4 Telp. (0274) 895042 Yogyakarta 55584

PENGUJIAN KADAR AIR

Proyek : Tugas Akhir
Asal Sampel : Pekalongan, Jawa Tengah

Dikerjakan : Pur
Tanggal : September 2006

No Pengujian	1		2	
	a	b	a	b
1				
2	21.66	21.8	21.55	21.98
3	55.79	53.21	52.74	44.78
4	43.53	41.87	41.52	36.53
5	12.26	11.34	11.22	8.25
6	21.87	20.07	19.97	14.55
7	56.059	56.502	56.184	56.701
8	Kadar Air rata-rata (%) 56.362			

Diperiksa Oleh :

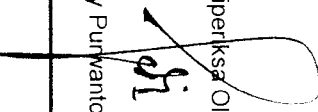
Dr. Ir. Edy Purwanto, CES, DEA



LAMPIRAN 2
Pengujian Berat Jenis Tanah

PENGUJIAN BERAT JENIS AGREGAT

Proyek : Ta
 Lokasi : Pekalongan, Jawa Tengah
 Kode sampel : 1
 kedalaman : 1.2 meter
 Penguji : Purwadi

AGREGAT HALUS (lolos #10)

No.	Kedalaman	1.2 meter	
1	No pengujian	1	2
2	Berat Picknometer (W1)	20.75	21.85
3	Berat Picknometer + tanah kering (W2)	36.53	41.04
4	Berat Picknometer + tanah + air (W3)	80.49	92.83
5	Berat Picknometer + air (W4)	70.8	81.13
6	Temperatur (t°)	23.00	23.00
7	Bj pata temperatu (t°)	0.996550	0.996550
8	Bj pata temperatu (27,5 °C)	0.996410	0.996410
7	Berat tanah kering (Wt)	15.78	19.19
8	A = Wt + W4	86.58	100.32
9	I = A - W3	6.09	7.49
10	Berat Jenis tanah, Gs = Wt / I	2.59	2.56
11	Bret Jenis = Gs. (Bj t° / Bj t 27,5 °C)	2.5915	2.5624
12	Berat jenis rata-rata	2.58	

LABORATORIUM MEKANIKA TANAH
 JURUSAN TEKNIK SIPIL FTSP
 UNIVERSITAS ISLAM INDONESIA

Diperiksa Oleh :

 Dr. Ir. Edy Purwanto, CES, DEA



LAMPIRAN 3
Pengujian Berat Volume Tanah

الجامعة الإسلامية
الابن سفيان



LABORATORIUM MEKANIKA TANAH
FAKULTAS TEKNIK SIPIL DAN PERENCANAAN UII

Jln. Kaliurang KM 14,4 Telp. (0274) 895042 Yogyakarta 55584

PENGUJIAN BERAT VOLUME

Proyek : Tugas Akhir
Asal Sampel : Pekalongan, Jawa Tengah

Dikerjakan : Pur
Tanggal : September 2006

No Pengujian	1	2
Diameter ring (d)	3.98	3.98
Tinggi cincin (t)	7.6	7.6
Volume ring (V)	94.504	94.504
Berat ring (W1)	135.65	135.65
Berat ring + tanah basah (W2)	277.04	274.47
Berat tanah basah (W2-W1)	161.74	158.96
Berat volume tanah (γ)	1.711	1.682
Berat volume rata-rata (gr/cm ³)	1.697	

Diperiksa Oleh :

Dr. Ir. Edy Purwanto, CES, DEA



LAMPIRAN 4
Pengujian Analisis Granuler

GRAIN SIZE ANALYSIS

Project : Tugas Akhir
 Sample no : 1
 Depth :
 Kode :
 Tested by : Purwadi
 Date : Oktober 2006
 Location : Pekalongan

Soil sample (disturbed/unclsturbed)

Mass of soil = 60 gr
 Specific Gravity, G_s = 2.580
 $K_2 = a/W \times 100 = 1.694531$

Hydrometer type = 152 H
 Hydr. Correction, a = 1.017
 Meniscus correction, m = 1

Sieve Analysis

Sieve No	Opening (mm)	Mass retained (gr)	Mass retained (gr)	% finer by mass $e/W \times 100\%$	Remarks
	90	0	60.00	100.00	
	75	0	60.00	100.00	
	63	0	60.00	100.00	
	50.8	0	60.00	100.00	
	38.1	0	60.00	100.00	
1	25.4	0	60.00	100.00	
3/4	19	0	e1 = 60.00	100.00	
	13.2	0	e2 = 60.00	100.00	
3/8	9.5	0	e3 = 60.00	100.00	
1/4	6.7	0	e4 = 60.00	100.00	
4	4.750	d1 = 0.00	e5 = 60.00	100.00	e7 = W - S1
10	2.000	d2 = 0.00	e6 = 60.00	100.00	e6 = d7 + e7
20	0.850	d3 = 0.26	e7 = 59.74	99.57	e5 = d6 + e6
40	0.425	d4 = 0.93	e8 = 58.81	98.02	e4 = d5 + e5
60	0.250	d5 = 3.67	e10 = 55.14	91.90	e3 = d4 + e4
140	0.106	d6 = 4.14	e11 = 51.00	85.00	e2 = d3 + e3
200	0.075	d7 = 3.24	e12 = 47.76	79.60	e1 = d2 + e2
		Sd = 12.24			

Hidrometer Analysis

Time	elapsed time min. T	R1	R2	t	R'	L	K	D	Kc = R1-R2+C	P K2 x R
					R1 + t			(mm)		(%)
12.48										
12.50	2	35	-2.0	24	36	10.401	0.0133	0.03043	33.3	64.90
12.53	5	33	-2.0	24	34	10.728	0.0133	0.019546	33.3	61.51
2.55	30	28	-2.0	24	29	11.547	0.0133	0.008279	33.3	53.04
13.48	60	25	-2.0	24	26	12.038	0.0133	0.005977	23.3	47.96
14.01	250	23	-2.0	23.5	24	12.365	0.0133	0.002568	23.3	44.57
12.48	1440	20	-2.0	23	21	12.857	0.0133	0.001281	23.3	39.48

Remarks :

$R_c = R_1 - R_2 + C_r$ (C_r = Temperatur correction factors)

$R' = R_1 + m$ (m correctoin for meniscus)

SOIL MECHANICS LABORATORY
 CIVIL ENGINEERING DEPARTEMENT
 ISLAMIC UNIVERSITY OF INDONESIA



SOIL MECHANIC LABORATORY
FACULTY OF ENGINEERING AND PLANNING
INDONESIAN ISLAMIC UNIVERSITY

GRAIN SIZE ANALYSIS
ASTM D1140 - 54

Project : Tugas Akhir
 Location : Cepagan, Pekalongan
 Sample no. : 2
 Depth : -
 Kode : -
 Tested by : Purwadi
 Date : Oktober 2006
 Berat jenis : 2.58

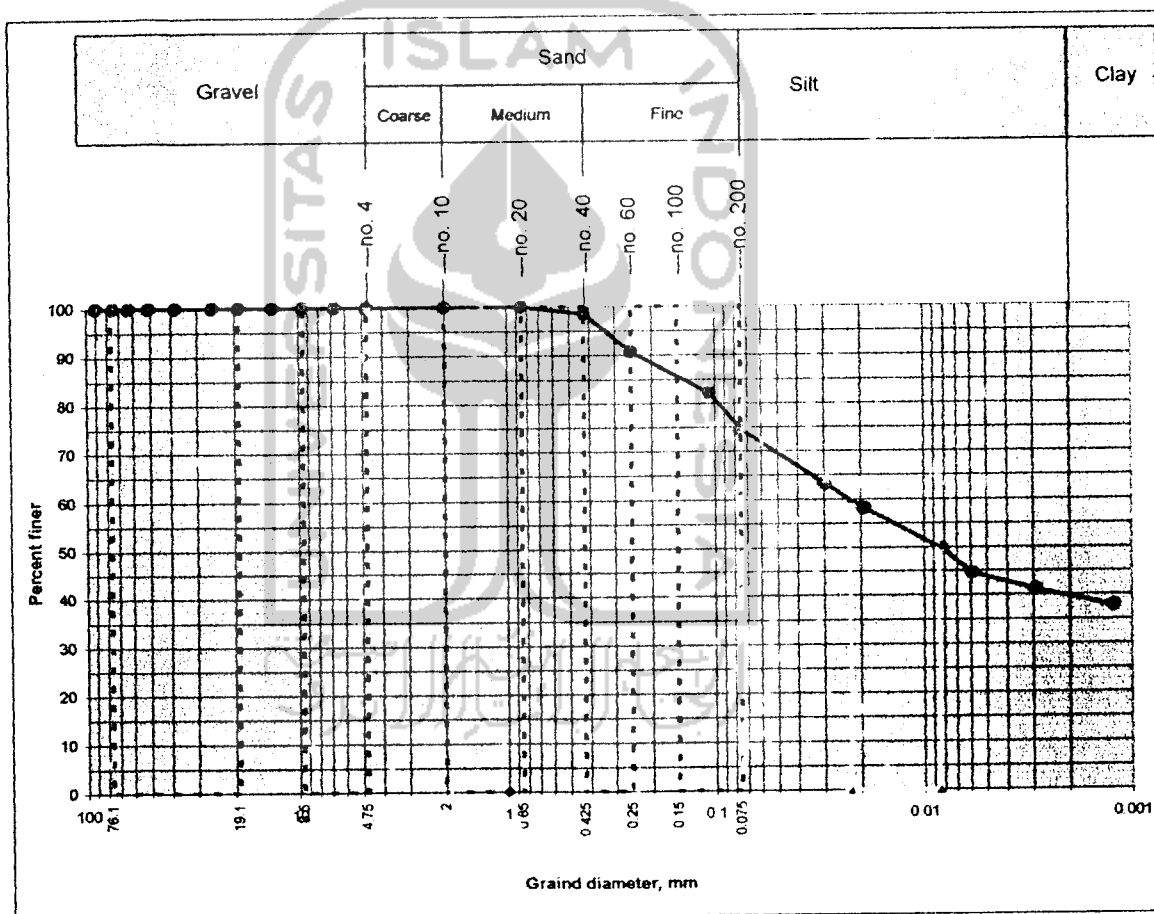

Finer # 200	74.700 %	D10 (mm)	#NUM!
		D30 (mm)	#NUM!
Gravel	0.000 %	D60 (mm)	0.023
Sand	25.300 %	Cu = D60/D10	#NUM!
Silt	35.434 %	Cc = D30 ² / (D10xD60)	#NUM!
Clay	39.266 %	D50(mm)	0.008

Diperiksa Oleh

Purwadi
 Dr. Ir. Eky Purwanto, CES, DEA

GRAIN SIZE ANALYSIS

Project : Tugas Akhir
 Sample no : 2
 Depth :
 Kode :
 Tested by : Purwadi
 Date : Oktober 2006
 Location : Cepagan, Pekalongan
 : Jawa Tengah

Soil sample (disturbed/undisturbed)

Mass of soil = 60 gr
 Specific Gravity, G_s = 2.580
 $K_2 = a/W \times 100 = 1.694531$
 Hydrometer type = 152 H
 Hydr. Correction, a = 1.017
 Meniscus correction, m = 1

Sieve Analysis

Sieve No	Opening (mm)	Mass retained (gr)	Mass retained (gr)	% finer $e/W \times 100\%$	Remarks
	90	0	60.00	100.00	
	75	0	60.00	100.00	
	63	0	60.00	100.00	
	50.8	0	60.00	100.00	
	38.1	0	60.00	100.00	
1	25.4	0	60.00	100.00	
3/4	19	0	e1 = 60.00	100.00	
	13.2	0	e2 = 60.00	100.00	
3/8	9.5	0	e3 = 60.00	100.00	
1/4	6.7	0	e4 = 60.00	100.00	
4	4.750	d1 = 0.00	e5 = 60.00	100.00	$e7 = W - S_d$
10	2.000	d2 = 0.00	e6 = 60.00	100.00	$e6 = d7 + e7$
20	0.850	d3 = 0.00	e7 = 60.00	100.00	$e5 = d6 + e6$
40	0.425	d4 = 0.93	e9 = 59.07	98.45	$e4 = d5 + e5$
60	0.250	d5 = 4.67	e10 = 54.40	90.67	$e3 = d4 + e4$
140	0.106	d6 = 5.14	e11 = 49.28	82.10	$e2 = d3 + e3$
200	0.075	d7 = 4.44	e12 = 44.82	74.70	$e1 = d2 + e2$
		$S_d = 15.18$			

Hidrometer Analysis

Time	elapsed time min. T	R1	R2	t	R'	L	K	D	Rc = R1-R2+C	P K2 x R
								(mm)		(%)
12.48										
12.50	2	34	-2.0	26	35	10.564	0.0129	0.029721	37.3	63.1
12.53	5	31	-2.0	28	32	11.058	0.0129	0.019229	34.3	58.12
2.55	30	28	-2.0	26	27	11.874	0.0129	0.008136	29.3	49.65
13.48	60	23	-2.0	26	24	12.365	0.0129	0.005871	26.3	44.57
14.01	250	21	-2.0	26	22	12.693	0.0129	0.002914	24.3	41.18
12.48	1440	19	-2.0	25.5	20	13.020	0.0129	0.00123	22.3	37.79

Remarks :

$R_c = R_1 - R_2 + C_r$ (C_r = Temperatur correction factors)

$R' = R_1 + m$ (m correctoin for meniscus)

SOIL MECHANICS LABORATORY
 CIVIL ENGINEERING DEPARTEMENT
 ISLAMIC UNIVERSITY OF INDONESIA



SOIL MECHANICS LABORATORY
FACULTY OF ENGINEERING AND PLANNING
INDONESIAN ISLAMIC UNIVERSITY

GRAIN SIZE ANALYSIS
ASTM D1140 - 54

Project : Tugas Akhir
 Location : Pekalongan
 Sample no. : 1
 Depth : -
 Kode :
 Tested by : Purwadi
 Date : Oktober 2006
 Berat jenis : 2.58

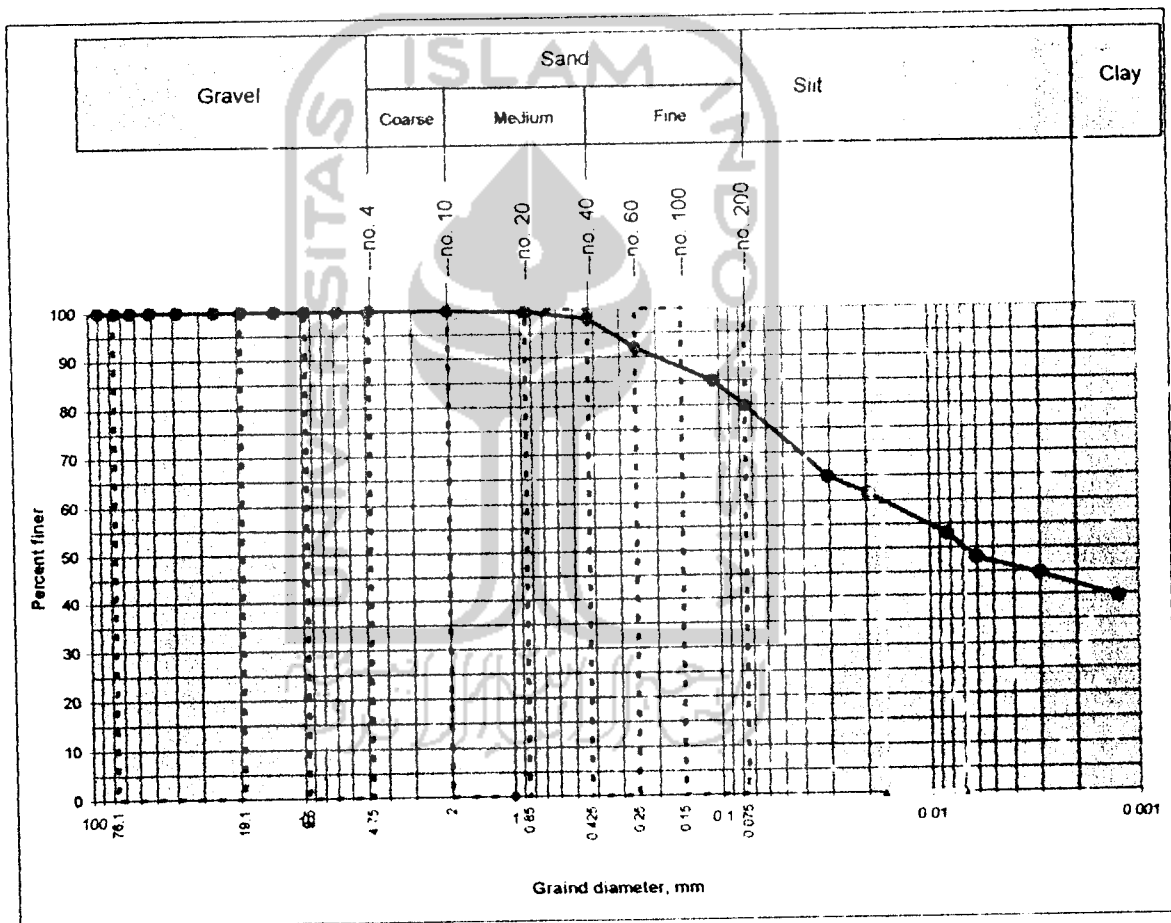

Finer # 200	79.600 %	D10 (mm)	#NUM!
		D30 (mm)	#NUM!
Gravel	0.000 %	D60 (mm)	0.017
Sand	20.400 %	$C_u = D_{60}/D_{10}$	#NUM!
Silt	37.774 %	$C_c = D_{30}^2 / (D_{10} \times D_{60})$	#NUM!
Clay	41.826 %	D50(mm)	0.007

Diperiksa Oleh

 Dr. Ir. Eddy Purwanto, CES, DEA



PROYEK
LOKASI
SAMPLE NO.

NO	
1	NO CAWA
2	Berat cawa
3	Berat cawa
4	Berat cawa
5	Berat air (3
6	Berat tanah
7	KADAR A
8	KADAR A
9	PUKULAI

PENGL

NO	
1	NO CAWA
2	BERAT C
3	BERAT C
4	BERAT C
5	BERAT AI
6	BERAT T.
7	KADAR A
8	KADAR A



Dig

Dr. Ir. Edy



LABORATORIUM MEKANIKA TANAH
JURUSAN TEKNIK SIPIL FTSP
UNIVERSITAS ISLAM INDONESIA

Jl. Kaliurang Km 14,4 Telp. (0274) 895042, 895707, Fax (0274) 895330. Jogjakarta.

PENGUJIAN BATAS CAIR

PROYEK : Tugas Akhir
LOKASI : Cepagan, Pekalongan, Jawa Tengah
SAMPLE NO. : 2

Tanggal : September 2006
 Dikerjakan : Purwadi

NO	NO. PENGUJIAN	I		II		III		IV	
		1	2	3	4	5	6	7	8
1	NO CAWAN								
2	Berat cawan kosong	22.03	22.05	20.06	21.87	21.26	21.24	21.71	22.10
3	Berat cawan + tanah basah (gr)	42.16	51.50	52.70	44.45	41.24	51.24	50.50	46.61
4	Berat cawan + tanah kering (gr)	35.33	41.49	41.68	36.87	34.64	41.35	41.33	38.90
5	Berat air (3) - (4)	6.83	10.01	11.02	7.58	6.60	9.89	9.17	7.71
6	Berat tanah kering (4) - (2)	13.30	19.44	21.62	15.00	13.38	20.11	19.62	16.80
7	(5) KADAR AIR = $\frac{\text{---}}{\text{---}} \times 100\% =$ (6)	51.35	51.49	50.97	50.53	49.33	49.18	46.74	45.89
8	KADAR AIR RATA-RATA =	51.42		50.75		49.25		46.32	
9	PUKULAN	10		21		36		46	

PENGUJIAN BATAS PLASTIS

NO			
		1	2
1	NO CAWAN		
2	BERAT CAWAN KOSONG	21.82	21.75
3	BERAT CAWAN + TANAH BASAH	31.95	39.85
4	BERAT CAWAN + TANAH KERING	29.24	34.98
5	BERAT AIR (3)-(4)	2.71	4.87
6	BERAT TANAH KERING (4)-(2)	7.42	13.23
7	(5) KADAR AIR = $\frac{\text{---}}{\text{---}} \times 100\% =$ (6)	36.52	36.81
8	KADAR AIR RATA-RATA =	36.67	

KESIMPULAN

FLOW INDEX	:	2.874
BATAS CAIR	:	49.35
BATAS PLASTIS	:	36.67
INDEX PLASTISITAS	:	12.68

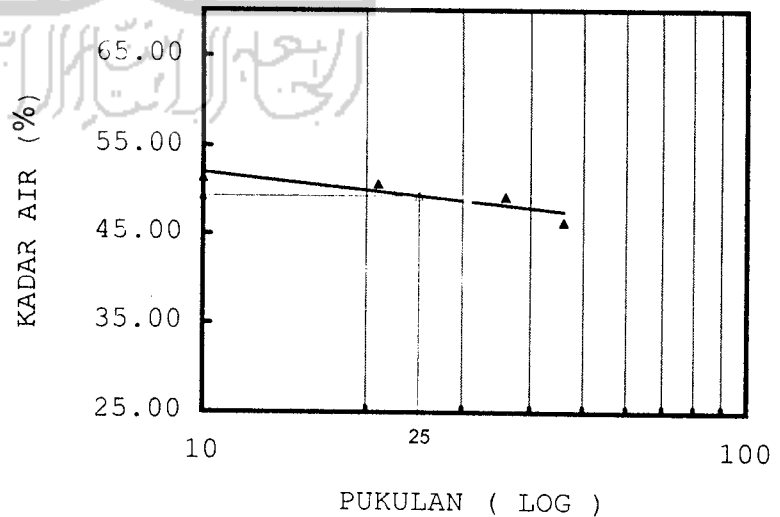

Diperiksa Oleh:

Dr. Ir. Eay Purwanto, C :S,DEA





PEMADATAN TANAH

Proctor test

PROYEK : Tugas Akhir
 Asal Sampel : Pekalongan
 NO Sampel : 1
 Komposisi : Tanah Lempung

DIKERJAKAN : Purwadi
 TANGGAL : 3-Sep-06

A SILINDER	
Diameter (ϕ) cm	9.89
Tinggi (H) cm	12.63
Volume (V) cm ³	970.25
Berat gram	1868

DATA PENUMBUK	
Berat (kg)	2.505
Jumlah lapis	3
Jumlah tumbukan /lapis	25
Tinggi jatuh	30.48

Berat jenis Gs : 2.43

PENAMBAHAN AIR

	2000	2000	2000	2000	2000
Berat tanah basah gram	10.31	10.31	10.31	10.31	10.31
Kadar air mula-mula %	5	10	15	20	27.5
Penambahan air ml	100	200	300	400	550

PEMADATAN SILINDER

	1	2	3	4	5
Nomor pengujian					
Berat silinder + tanah padat gram	3280	3451	3545	3553	3510
Berat tanah padat gram	1412	1583	1677	1685	1642
Berat volume tanah gr/cm ³	1.455	1.632	1.728	1.737	1.692

PEMADATAN KADAR AIR

NOMOR PERCOBAAN	1		2		3		4		5	
	a	b	a	b	a	b	a	b	a	b
Nomor cawan										
Berat cawan kosong gram	21.97	21.94	21.96	21.94	21.93	21.81	21.69	21.62	21.80	21.96
Berat cawan + tanah basah gram	40.99	37.95	38.72	36.49	45.43	43.07	43.91	47.09	45.23	42.08
Berat cawan + tanah kering gram	38.43	35.84	35.47	33.73	40.00	38.15	38.58	40.91	38.41	36.24
Kadar air = w %	15.55	15.07	24.06	23.41	30.05	30.11	31.56	32.04	41.06	40.90
Kadar air rata-rata		15.31		23.73		30.08		31.80		40.98
Berat volume tanah kering gr/cm ³		1.262		1.319		1.329		1.318		1.200

BERAT VOLUME KERING
 MAKSIMUM (gr/cm³)

1.33434

KADAR AIR OPTIMUM (%)

27.71

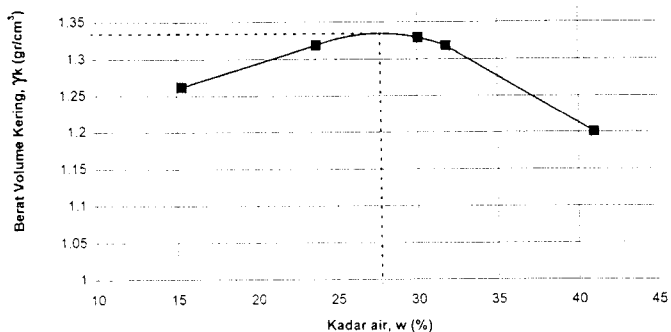

Diperiksa :

Dr. Ir. Edy Purwanto, CES, DEA



PEMADATAN TANAH

Proctor test

ROYEK : Tugas Akhir
 asal Sampel : Pekalongan
 No Sampel : 2
 komposisi : Tanah Lempung

DIKERJAKAN : Purwadi
 TANGGAL : 3-Sep-06

SILINDER	
diameter (ϕ) cm	9.89
tinggi (H) cm	12.63
volume (V) cm ³	970.25
berat gram	1868

DATA PENUMBUK	
Berat (kg)	2.505
Jumlah lapis	3
Jumlah tumbukan /lapis	25
Tinggi jatuh	30.48

berat jenis Gs : 2.43

PENAMBAHAN AIR

	2000	2000	2000	2000	2000
berat tanah basah gram	3003	3204	3465	3363	3321
kelembaban air mula-mula %	10.63	10.63	10.63	10.63	10.63
penambahan air %	5	10	15	20	27.5
penambahan air ml	100	200	300	400	550

UJIAN PEMADATAN SILINDER

nomor pengujian	1	2	3	4	5
berat silinder + tanah padat gram	3003	3204	3465	3363	3321
berat tanah padat gram	1135	1336	1597	1495	1453
berat volume tanah gr/cm ³	1.170	1.377	1.646	1.541	1.498

UJIAN KADAR AIR

OMOR PERCOBAAN	1		2		3		4		5	
nomor cawan	a	b	a	b	a	b	a	b	a	b
berat cawan kosong gram	21.38	22.21	22.03	22.05	22.03	21.80	22.20	21.67	21.71	21.83
berat cawan + tanah basah gram	30.27	38.01	31.67	31.65	45.25	40.00	50.80	52.23	48.66	58.88
berat cawan + tanah kering gram	29.08	35.73	29.91	29.90	40.24	36.01	43.97	44.91	41.08	48.36
kelembaban air = w %	15.45	16.86	22.34	22.29	27.51	28.08	31.37	31.50	39.13	39.65
kelembaban air rata-rata	16.16		22.31		27.80		31.44		39.39	
berat volume tanah kering gr/cm ³	1.007		1.126		1.288		1.172		1.074	

KELEMBABAN AIR OPTIMUM (gr/cm³)

1.28994

KELEMBABAN AIR OPTIMUM (%)

27.25

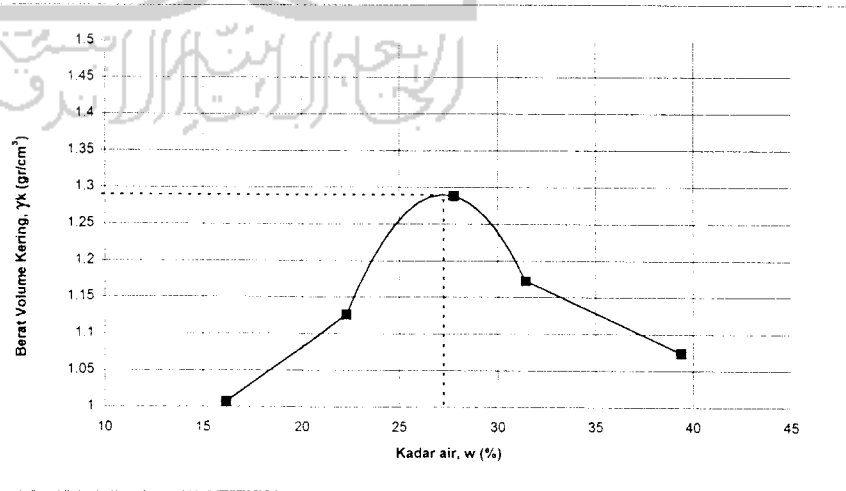

Diperiksa :

Dr. Ir. Edy Purwanto, CES, DEA



LAMPIRAN 7
Pengujian Tekan Bebas Tanah Undisturb



LABORATORIUM MEKANIKA TANAH
JURUSAN TEKNIK SIPIL-FTSP
UNIVERSITAS ISLAM INDONESIA

UNCONFINED COMPRESSION TEST

Proyek : Tugas Akhir
 Location : Cepagan, Pekalongan, Jawa Tengah
 Depth : - 1,20 meter

Date : September 2006
 Tested by : Purwadi
 Kode : 1

data	
n)	
n ²)	11.3411
m)	
i)	36.149
wt (gr/cm ³)	1.76

Water Content		
Wt Container (cup), gr	21.66	21.80
Wt of Cup + Wet soil, gr	55.790	53.21
Wt of Cup + Dry soil, gr	43.53	41.87
Water Content %	56.06	56.50
Average water content %	56.28	

LRC = 0.5083 kg/div

ation ling (⁻²)	Load dial (unit)	Unit Strain ($\Delta L/L_0$)	Total load on sample (kg)	Sample stress (kg/cm ²)
0	0	0.00%	0	0
40	0.5	0.53%	0.25415	0.022292
80	1.5	1.05%	0.76245	0.066521
120	2.5	1.58%	1.27075	0.110279
160	3.9	2.11%	1.98237	0.171115
200	5	2.63%	2.5415	0.218198
240	6	3.16%	3.0498	0.260423
280	6.9	3.68%	3.50727	0.297858
320	7.5	4.21%	3.81225	0.32199
360	8.2	4.74%	4.16806	0.350108
400	9	5.26%	4.5747	0.382142
440	9.8	5.79%	4.98134	0.413798
480	10	6.32%	5.083	0.419884
520	10.6	6.84%	5.38798	0.442577
560	10.9	7.37%	5.54047	0.452531
600	11.1	7.89%	5.64213	0.458216
640	11.5	8.42%	5.84545	0.472016
680	11.8	8.95%	5.99794	0.481546
720	12.5	9.47%	6.35375	0.507163
760	12.9	10.00%	6.55707	0.52035
800	13.4	10.53%	6.81122	0.537357
840	13.9	11.05%	7.06537	0.554129
880	14.2	11.58%	7.21786	0.562739
920	14.5	12.11%	7.37035	0.571208
960	14	12.63%	7.1162	0.548208
1000	12	13.16%	6.0996	0.467062

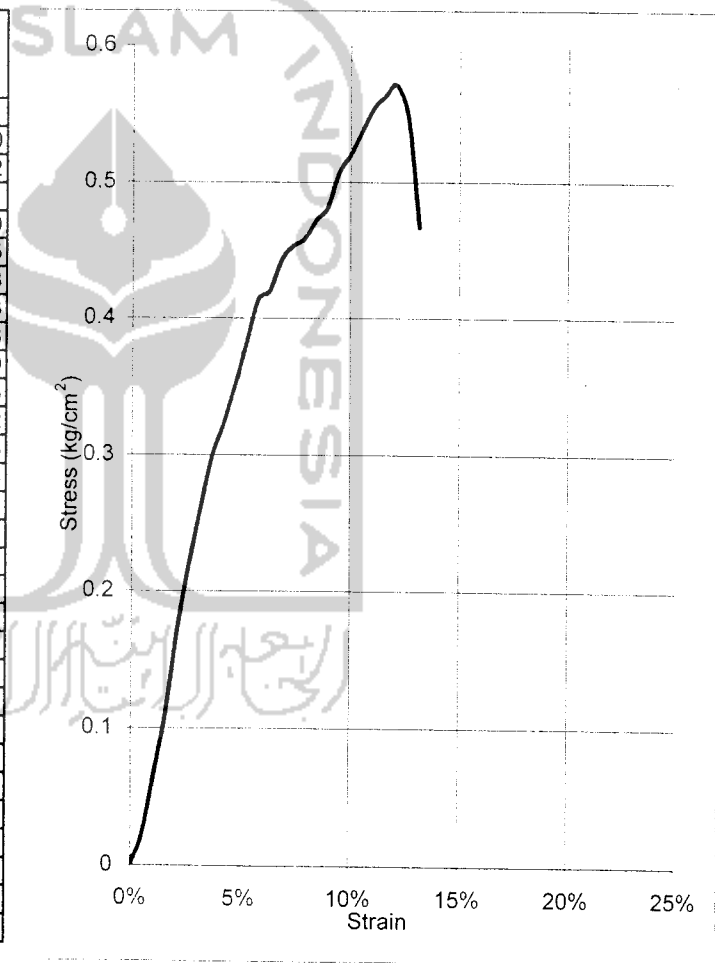

qu =	0.57121 kg/cm ²
α =	53°
Angle Of Internal friction, ϕ =	16°
Cohesion =	0.215 kg/cm ²

Diperiksa Oleh

r. Edy Purwanto, CES, DEA



LABORATORIUM MEKANIKA TANAH
JURUSAN TEKNIK SIPIL-FTSP
UNIVERSITAS ISLAM INDONESIA

UNCONFINED COMPRESSION TEST

Proyek : Tugas Akhir
 Location : Cepagan, Pekalongan, Jawa Tengah
 Depth : - 1,20 meter

Date : September 2006
 Tested by : Purwadi
 Kode : 2

data	
m)	
m ²)	11.3411
cm)	
i ³)	86.149
lit wt (gr/cm ³)	1.74

Water Content		
Wt Container (cup), gr	21.66	21.80
Wt of Cup + Wet soil, gr	55.790	53.21
Wt of Cup + Dry soil, gr	43.53	41.87
Water Content %	56.06	56.50
Average water content %	56.28	

LRC = 0.5083 kg/div

Reading (J ²)	Load dial (unit)	Unit Strain (ΔL/L ₀)	Total load on sample (kg)	Sample stress (kg/cm ²)
0	0	0.00%	0	0
40	1	0.53%	0.5083	0.044583
80	2	1.05%	1.0166	0.088695
120	2.8	1.58%	1.42324	0.123512
160	3.2	2.11%	1.62656	0.140402
200	4	2.63%	2.0332	0.174559
240	4.6	3.16%	2.33818	0.199657
280	5	3.68%	2.5415	0.215839
320	6	4.21%	3.0498	0.257592
360	6.4	4.74%	3.25312	0.273255
400	7	5.26%	3.5581	0.297221
440	7.5	5.79%	3.81225	0.316682
480	8	6.32%	4.0664	0.335907
520	8.9	6.84%	4.52387	0.371597
560	9.3	7.37%	4.72719	0.386105
600	10	7.89%	5.083	0.412807
640	10.2	8.42%	5.18466	0.418657
680	11.1	8.95%	5.64213	0.452979
720	11.8	9.47%	5.99794	0.478762
760	12.05	10.00%	6.125015	0.486063
800	12.9	10.53%	6.55707	0.517307
840	13.5	11.05%	6.86205	0.538183
880	14	11.58%	7.1162	0.554813
920	14.2	12.11%	7.21786	0.559389
960	14.3	12.63%	7.26869	0.559956
1000	13	13.16%	6.6079	0.505984

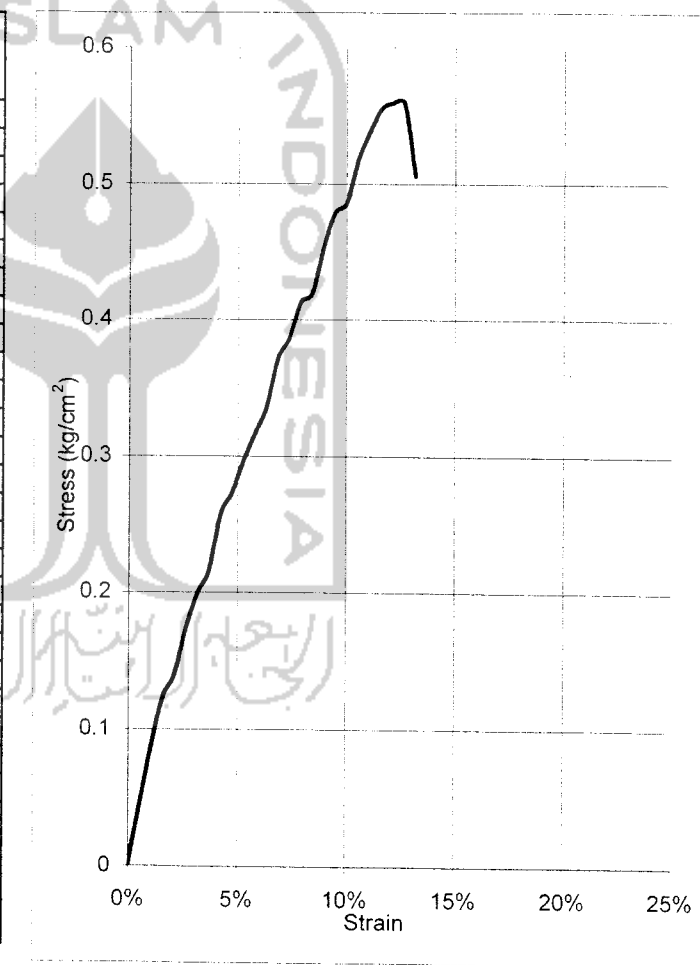

q _u =	0.55996 kg/cm ²
α =	52 °
Angle Of Internal friction, φ =	14 °
Cohesion =	0.219 kg/cm ²

Diperiksa Oleh :

Ir. Edy Purwanto, CES, DEA



LAMPIRAN 8

Pengujian Tekan Bebas Tanah + Karbid 1.5%



LABORATORIUM MEKANIKA TANAH
JURUSAN TEKNIK SIPIL-FTSP
UNIVERSITAS ISLAM INDONESIA

UNCONFINED COMPRESSION TEST

Proyek : Tugas Akhir
 Location : Cepagan, Pekalongan, Jawa Tengah
 Depth : - 1,20 meter

Date : September 2006
 Tested by : Purwadi
 Kode : Lempung + Karbid 1,5% (1) 3hari

Volume data	
(cm)	
(m ²)	11.3411
(cm)	
(m ³)	83.882
	1.87
Unit wt (gr/cm ³)	1.87

Water Content	
Wt Container (cup), gr	
Wt of Cup + Wet soil, gr	
Wt of Cup + Dry soil, gr	
Water Content %	
Average water content %	27.71

LRC = 0.5083 kg/div

Load dial (0 ⁻²)	Load dial (unit)	Unit Strain (ΔL/Lo)	Total load on sample (kg)	Sample stress (kg/cm ²)
0	0	0.00%	0	0
20	6	0.27%	3.0498	0.268188
40	11	0.54%	5.5913	0.490345
60	14	0.81%	7.1162	0.62238
80	17	1.08%	8.6411	0.753688
100	21	1.35%	10.6743	0.928482
120	25	1.62%	12.7075	1.102307
140	31	1.89%	15.7573	1.363106
160	36	2.16%	18.2988	1.578601
180	41	2.43%	20.8403	1.792885
200	46	2.70%	23.3818	2.005957
220	48	2.97%	24.3984	2.087358
240	52	3.24%	26.4316	2.255006
260	57	3.51%	28.9731	2.464929
280	60	3.78%	30.498	2.587394
300	61	4.05%	31.0063	2.623128
320	62.5	4.32%	31.76875	2.68006
340	68	4.59%	34.5644	2.907669
360	71	4.86%	36.0893	3.027348
380	79	5.14%	40.1557	3.358888
400	82	5.41%	41.6806	3.476508
420	82	5.68%	41.6806	3.466575
440	79	5.95%	40.1557	3.33018
460	71	6.22%	36.0893	2.984346

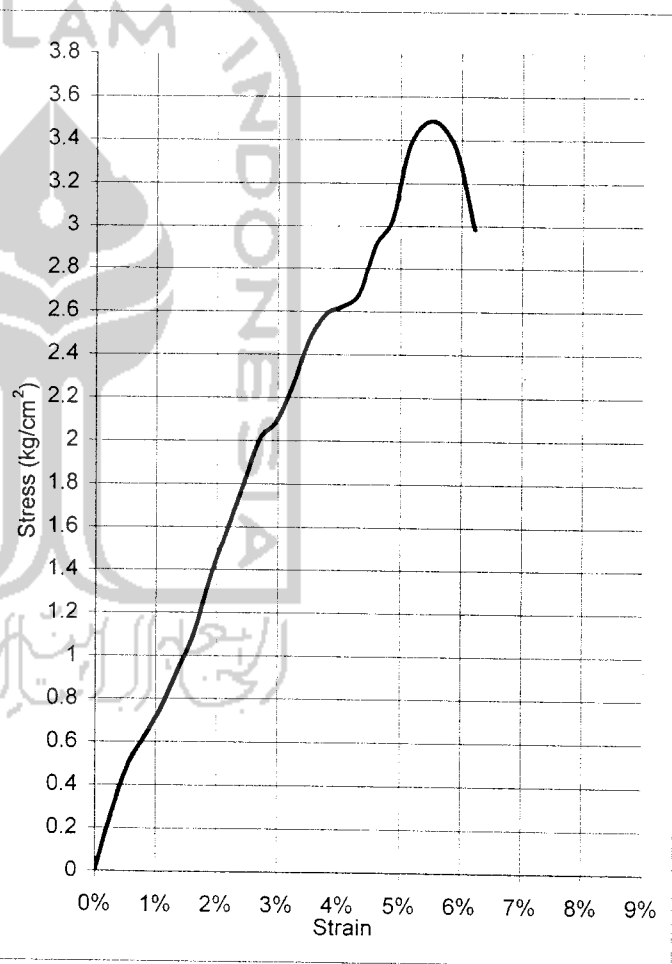

qu = 3.47651 kg/cm²
 α = 61°
 Angle Of Internal friction, φ = 32°
 Cohesion = 0.964 kg/cm²

Diperiksa Oleh :

Dr. Ir. Eddy Purwanto, CES, DEA



LABORATORIUM MEKANIKA TANAH
JURUSAN TEKNIK SIPIL-FTSP
UNIVERSITAS ISLAM INDONESIA

UNCONFINED COMPRESSION TEST

Proyek : Tugas Akhir
 Location : Cepagan, Pekalongan, Jawa Tengah
 Depth : - 1,20 meter

Date : September 2006
 Tested by : Purwadi
 Kode : Lempung + karbid 1,5% (2)

data	
m)	
m ²)	10.7521
cm)	
m ³)	80.0625
lit wt (gr/cm ³)	1.96

Water Content	
Wt Container (cup), gr	
Wt of Cup + Wet soil, gr	
Wt of Cup + Dry soil, gr	
Water Content %	
Average water content %	27.71

LRC = 0.5083 kg/div

Load dial (unit)	Unit Strain (ΔL/Lo)	Total load on sample (kg)	Sample stress (kg/cm ²)
0	0.00%	0	0
20	0.27%	4.0664	0.377181
40	0.54%	9.6577	0.893393
60	0.81%	14.2324	1.313025
80	1.07%	21.3486	1.964207
100	1.34%	27.4482	2.518556
120	1.61%	32.5312	2.976833
140	1.88%	35.0727	3.200641
160	2.15%	39.1391	3.561958
180	2.42%	41.1723	3.736715
200	2.68%	42.1889	3.818446
220	2.95%	43.2055	3.899669
240	3.22%	44.7304	4.026136
260	3.49%	44.7304	4.014968
280	3.76%	44.2221	3.958302
300	4.03%	43.2055	3.856519

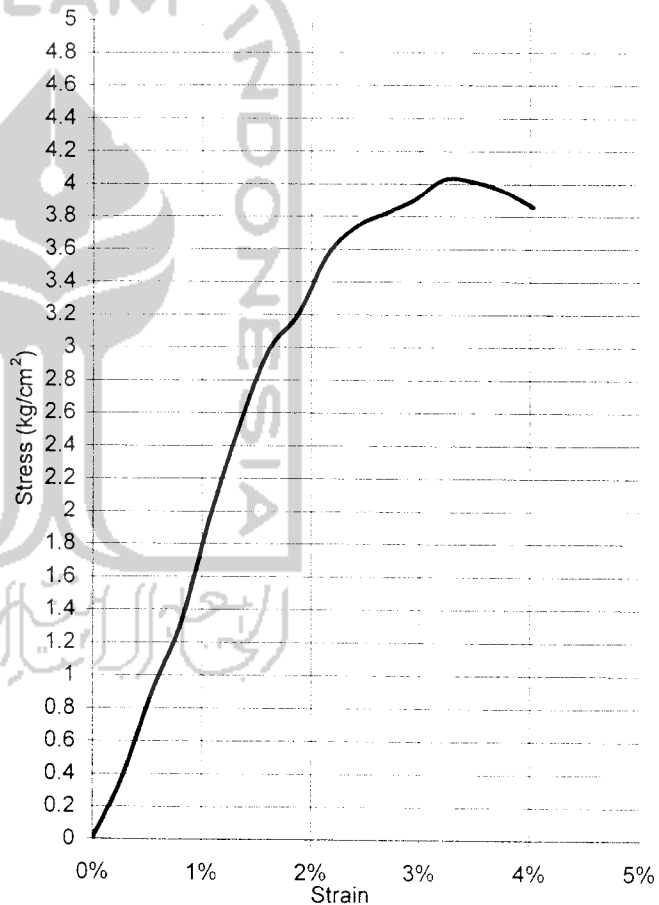

qu =	4.02614 kg/cm ²
α =	62 °
Angle Of Internal friction, φ =	34 °
Cohesion =	1.070 kg/cm ²

Diperiksa Oleh :

Dr. Ir. Edy Purwanto, CES, DEA



LABORATORIUM MEKANIKA TANAH
JURUSAN TEKNIK SIPIL FTSP
UNIVERSITAS ISLAM INDONESIA

Jl. Kaliurang Km 14,4 Telp. (0274) 895042, 895707, Fax (0274) 895330. Jogjakarta.

PENGUJIAN BATAS CAIR

PROYEK : Tugas Akhir
 LOKASI : Cepagan, Pekalongan, Jawa Tengah
 SAMPLE NO. : 1

Tanggal : September 2006
 Dikerjakan : Purwadi

NO	NO. PENGUJIAN	I		II		III		IV	
		1	2	3	4	5	6	7	8
1	NO CAWAN								
2	Berat cawan kosong	22.51	22.02	21.82	23.00	21.69	21.94	21.05	20.24
3	Berat cawan + tanah basah (gr)	43.40	39.32	39.78	49.21	39.40	41.28	50.21	47.25
4	Berat cawan + tanah kering (gr)	36.21	33.31	33.78	40.45	33.55	34.97	40.79	38.35
5	Berat air (3) - (4)	7.19	6.01	6.00	8.76	5.85	6.31	9.42	8.90
6	Berat tanah kering (4) - (2)	13.70	11.29	11.96	17.45	11.86	13.03	19.74	18.11
7	KADAR AIR = $\frac{(5)}{(6)} \times 100\% =$	52.48	53.23	50.17	50.20	49.33	48.43	47.72	49.14
8	KADAR AIR RATA-RATA =	52.86		50.18		48.88		48.43	
9	PUKULAN		17		24		34		44

PENGUJIAN BATAS PLASTIS

NO		1	2
1	NO CAWAN		
2	BERAT CAWAN KOSONG	21.66	22.52
3	BERAT CAWAN + TANAH BASAH	28.24	28.63
4	BERAT CAWAN + TANAH KERING	26.55	27.07
5	BERAT AIR (3)-(4)	1.69	1.56
6	BERAT TANAH KERING (4)-(2)	4.89	4.55
7	KADAR AIR = $\frac{(5)}{(6)} \times 100\% =$	34.56	34.29
8	KADAR AIR RATA-RATA =	34.42	

KESIMPULAN
 FLOW INDEX : 4.474
 BATAS CAIR : 50.60
 LINTAS PLASTIS : 34.42
 INDEX PLASTISITAS : 16.18

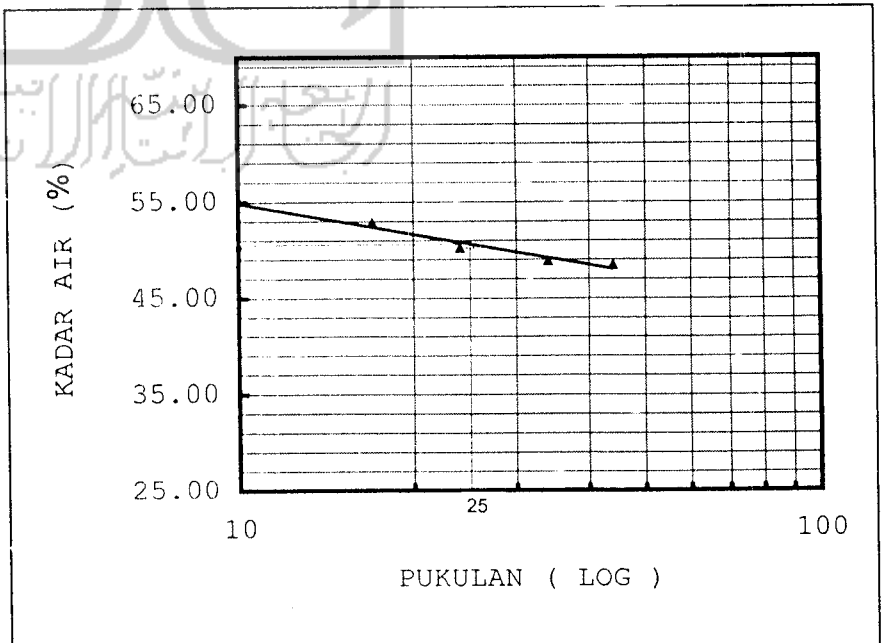

Diperiksa Oleh:

Dr. Ir. Edy Purwanto, CES, DEA



LABORATORIUM MEKANIKA TANAH
JURUSAN TEKNIK SIPIL-FTSP
UNIVERSITAS ISLAM INDONESIA

UNCONFINED COMPRESSION TEST

Proyek : Tugas Akhir
 Location : Cepagan, Pekalongan, Jawa Tengah
 Depth : - 1,20 meter

Date : September 2006
 Tested by : Purwadi
 Kode : Lempung + Karbid 1,5% (1) 7hari

data	
n)	
n ²)	11.3411
m)	
s ³)	83.882
wt (gr/cm ³)	1.74

Water Content	
Wt Container (cup), gr	
Wt of Cup + Wet soil, gr	
Wt of Cup + Dry soil, gr	
Water Content %	
Average water content %	27.71

LRC = 0.5083 kg/div

ation ding (²)	Load dial (unit)	Unit Strain (ΔL/Lo)	Total load on sample (kg)	Sample stress (kg/cm ²)
0	0	0.00%	0	0
20	2	0.27%	1.0166	0.089396
40	5	0.54%	2.5415	0.222884
60	7	0.81%	3.5581	0.31119
80	8	1.08%	4.0664	0.354676
100	10	1.35%	5.083	0.442134
120	14	1.62%	7.1162	0.617292
140	15	1.89%	7.6245	0.659567
160	20	2.16%	10.166	0.877001
180	23	2.43%	11.6909	1.005765
200	25	2.70%	12.7075	1.090194
220	28	2.97%	14.2324	1.217626
240	30	3.24%	15.249	1.300965
260	36	3.51%	18.2988	1.556797
280	39	3.78%	19.8237	1.681806
300	42	4.05%	21.3486	1.806088
320	45	4.32%	22.8735	1.929644
340	50	4.59%	25.415	2.137992
360	59	4.86%	29.9897	2.515683
380	64	5.14%	32.5312	2.721124
400	67	5.41%	34.0561	2.840561
420	70	5.68%	35.581	2.959271
440	71	5.95%	36.0893	2.992946
460	73	6.22%	37.1059	3.068412
480	72	6.49%	36.5976	3.017657
500	69	6.76%	35.0727	2.883563

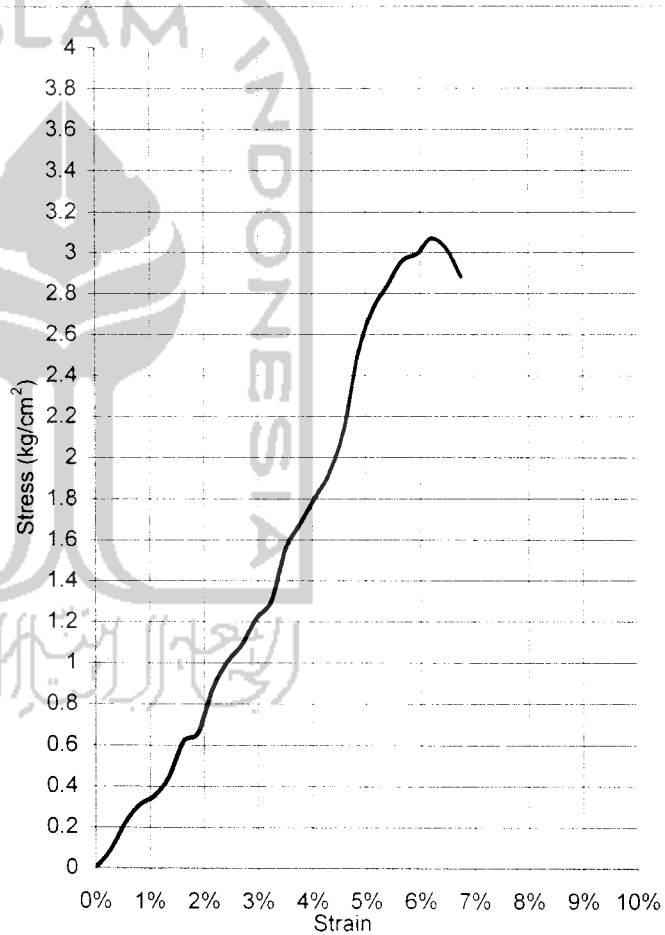

qu =	3.06841 kg/cm ²
α =	60 °
Angle Of Internal friction, φ =	30 °
Cohesion =	0.886 kg/cm ²

Diperiksa Oleh :

Dr. Ir. Edy Purwanto, CES, DEA



LABORATORIUM MEKANIKA TANAH

JURUSAN TEKNIK SIPIL-FTSP

UNIVERSITAS ISLAM INDONESIA

UNCONFINED COMPRESSION TEST

Proyek : Tugas Akhir
 Location : Cepagan, Pekalongan, Jawa Tengah
 Depth : - 1,20 meter

Date : September 2006
 Tested by : Purwadi
 Kode : Lempung + karbid 1,5% (2) 7hari

data	
n)	
γ^2)	10.7521
n)	
)	80.0625
wt (gr/cm ³)	1.74

Water Content		
Wt Container (cup), gr		
Wt of Cup + Wet soil, gr		
Wt of Cup + Dry soil, gr		
Water Content %		
Average water content %	27.71	

LRC = 0.5083 kg/div

ation ing (²)	Load dial (unit)	Unit Strain ($\Delta L/L_0$)	Total load on sample (kg)	Sample stress (kg/cm ²)
0	0	0.00%	0	0
20	5	0.27%	2.5415	0.235738
40	7	0.54%	3.5581	0.329145
60	13	0.81%	6.6079	0.609619
80	20	1.07%	10.166	0.935337
100	27	1.34%	13.7241	1.259278
120	38	1.61%	19.3154	1.767495
140	50	1.88%	25.415	2.319305
160	55	2.15%	27.9565	2.544256
180	58	2.42%	29.4814	2.675672
200	60	2.68%	30.498	2.760322
220	62	2.95%	31.5146	2.844464
240	61	3.22%	31.0063	2.790844
260	58	3.49%	29.4814	2.646229

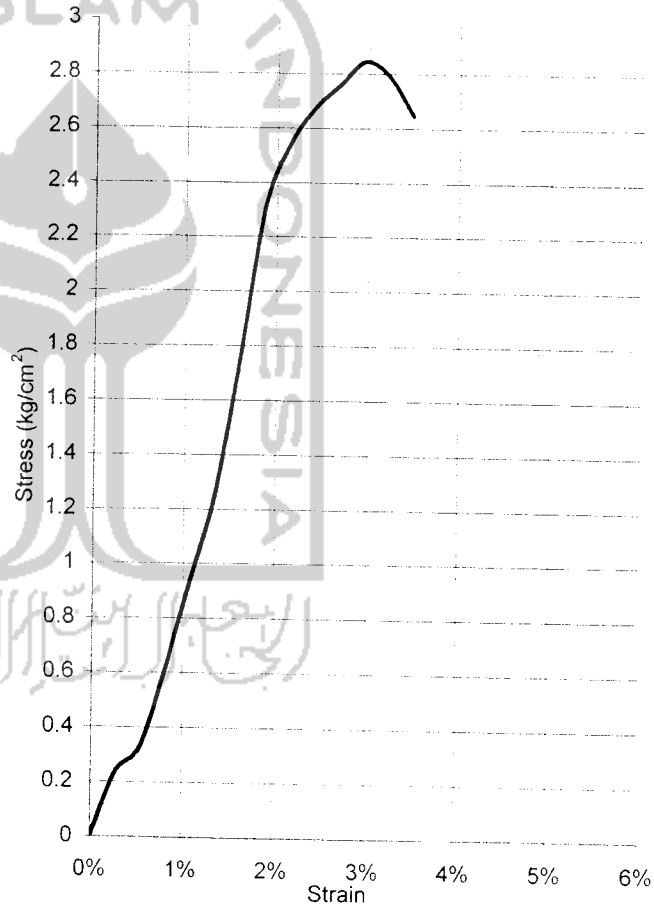

qu =	2.84446 kg/cm ²
α =	61°
Angle Of Internal friction, ϕ =	32°
Cohesion =	0.788 kg/cm ²

Diperiksa Oleh :

Dr. Ir. Edy Purwanto, CES, DEA



LABORATORIUM MEKANIKA TANAH
JURUSAN TEKNIK SIPIL-FTSP
UNIVERSITAS ISLAM INDONESIA

UNCONFINED COMPRESSION TEST

Proyek : Tugas Akhir
 Location : Cepagan, Pekalongan, Jawa Tengah
 Depth :- 1,20 meter

Date : September 2006
 Tested by : Purwadi
 Kode : Lempung + Karbid 1,5% (1)
 14hari

lata	
)	
2)	11.3411
)	
	83.882
wt (gr/cm ³)	1.72

Water Content		
Wt Container (cup), gr		
Wt of Cup + Wet soil, gr		
Wt of Cup + Dry soil, gr		
Water Content %		
Average water content %		27.71

LRC = 0.5083 kg/div

tion ng (³)	Load dial (unit)	Unit Strain (ΔL/Lo)	Total load on sample (kg)	Sample stress (kg/cm ²)
0	0	0.00%	0	0
20	7	0.27%	3.5581	0.312886
40	13	0.54%	6.6079	0.579499
60	35	0.81%	17.7905	1.555949
80	50	1.08%	25.415	2.216728
100	58	1.35%	29.4814	2.564279
120	60	1.62%	30.498	2.645538
140	60	1.89%	30.498	2.63827
160	58	2.16%	29.4814	2.543302
180	55	2.43%	27.9565	2.405089

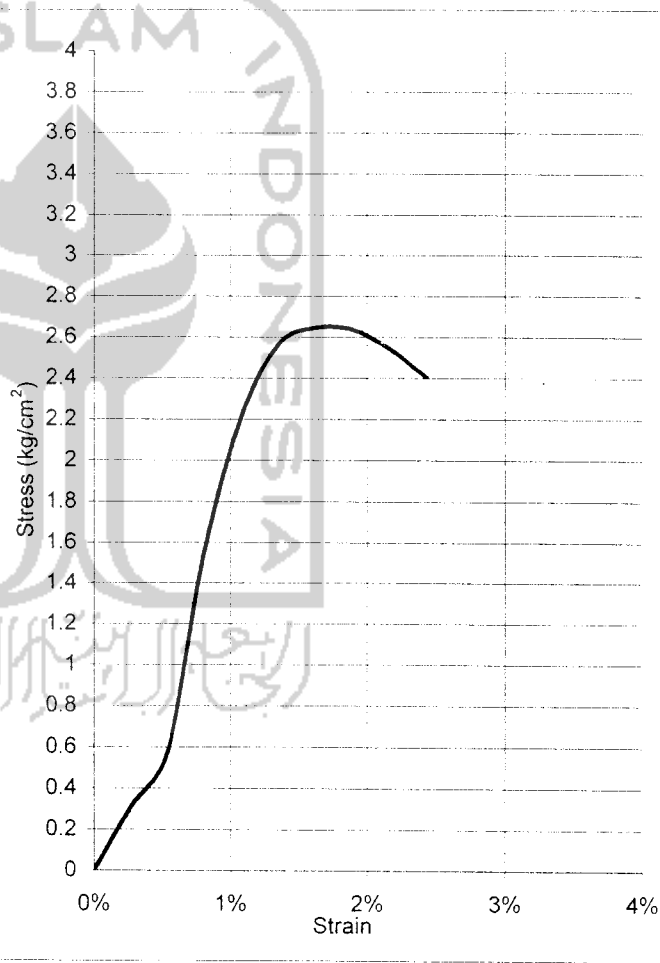

qu	=	2.64554 kg/cm ²
α	=	60 °
Angle Of internal friction, φ	=	30 °
Cohesion	=	0.764 kg/cm ²

Diperiksa Oleh :

Dr. Ir. Edy Purwanto, CES, DEA



LABORATORIUM MEKANIKA TANAH
JURUSAN TEKNIK SIPIL-FTSP
UNIVERSITAS ISLAM INDONESIA

UNCONFINED COMPRESSION TEST

Proyek : Tugas Akhir
 Location : Cepagan, Pekalongan, Jawa Tengah
 Depth : - 1,20 meter

Date : September 2006
 Tested by : Purwadi
 Kode : Lempung + karbid 1,5% (2)
 14hari

data	
n)	
n ²)	11.3411
m)	
s)	84.4487
t wt (gr/cm ³)	1.73

Water Content	
Wt Container (cup), gr	
Wt of Cup + Wet soil, gr	
Wt of Cup + Dry soil, gr	
Water Content %	
Average water content %	27.71

LRC = 0.5083 kg/div

ation ting (⁻²)	Load dial (unit)	Unit Strain ($\Delta L/L_0$)	Total load on sample (kg)	Sample stress (kg/cm ²)
0	0	0.00%	0	0
20	5	0.27%	2.5415	0.223494
40	12	0.54%	6.0996	0.534941
60	21	0.81%	10.6743	0.933621
80	40	1.07%	20.332	1.773512
100	45	1.34%	22.8735	1.989787
120	55	1.61%	27.9565	2.425344
140	56	1.88%	28.4648	2.462704
160	57	2.15%	28.9731	2.499822
180	58	2.42%	29.4814	2.5367
200	54	2.68%	27.4482	2.355258

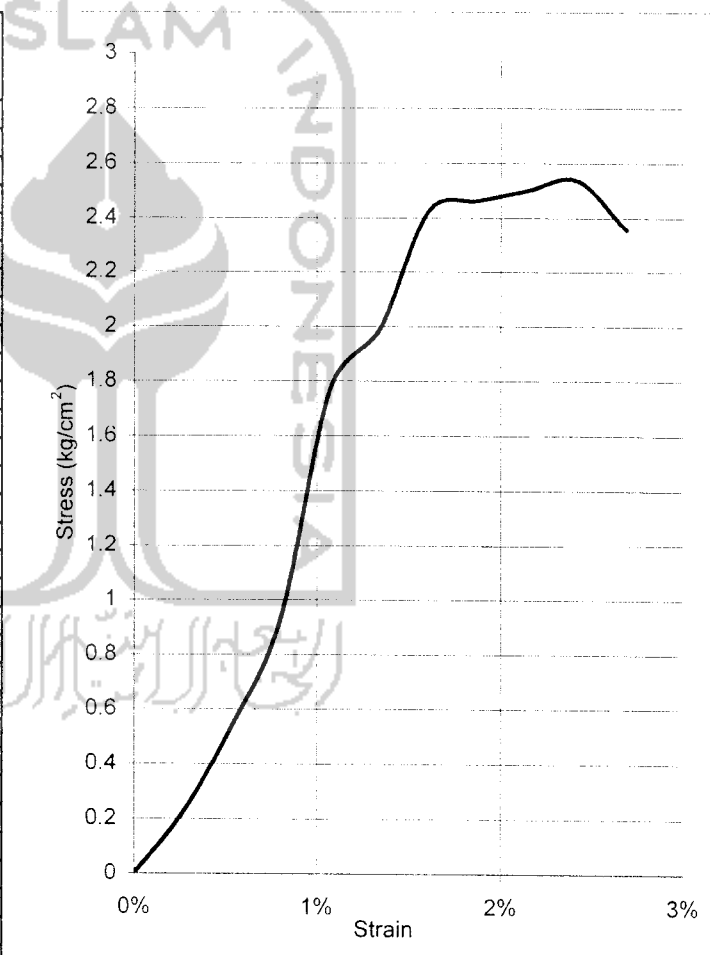

qu =	2.53670 kg/cm ²
$\alpha =$	61 °
Angle Of Internal friction, $\phi =$	32 °
Cohesion =	0.703 kg/cm ²

Diperiksa Oleh :

Dr. Ir. Edy Purwanto, CES, DEA



LAMPIRAN 9

Pengujian Tekan Bebas Tanah + Karbid 3%



LABORATORIUM MEKANIKA TANAH
JURUSAN TEKNIK SIPIL-FTSP
UNIVERSITAS ISLAM INDONESIA

UNCONFINED COMPRESSION TEST

Proyek : Tugas Akhir
 Location : Cepagan, Pekalongan, Jawa Tengah
 Depth : - 1,20 meter

Date : September 2006
 Tested by : Purwadi
 Kode : Lempung + Karbid 3% (1) 3 hari

data	
n)	3.8
n ²)	11.3411
m)	7.4
s ³)	83.882
	150.47
t wt (gr/cm ³)	1.79

Water Content	
Wt Container (cup), gr	
Wt of Cup + Wet soil, gr	
Wt of Cup + Dry soil, gr	
Water Content %	
Average water content %	27.71

LRC = 0.5083 kg/div

ation ting (- ²)	Load dial (unit)	Unit Strain (ΔL/Lo)	Total load on sample (kg)	Sample stress - (kg/cm ²)
0	0	0.00%	0	0
20	10	0.27%	5.083	0.44698
40	15	0.54%	7.6245	0.668652
60	20	0.81%	10.166	0.889114
80	25	1.08%	12.7075	1.108364
100	26	1.35%	13.2158	1.149549
120	28	1.62%	14.2324	1.234584
140	30	1.89%	15.249	1.319135
160	34	2.16%	17.2822	1.490901
180	37	2.43%	18.8071	1.617969
200	39	2.70%	19.8237	1.700703
220	42	2.97%	21.3486	1.826438
240	46	3.24%	23.3818	1.994813
260	49	3.51%	24.9067	2.118974
280	50	3.78%	25.415	2.156162
300	54	4.05%	27.4482	2.322113
320	58	4.32%	29.4814	2.487096
340	66	4.59%	33.5478	2.822149
360	75	4.86%	38.1225	3.197903
380	78.5	5.14%	39.90155	3.337629
400	80	5.41%	40.664	3.391715
420	85	5.68%	43.2055	3.593401
440	90	5.95%	45.747	3.793875
460	83	6.22%	42.1889	3.488742

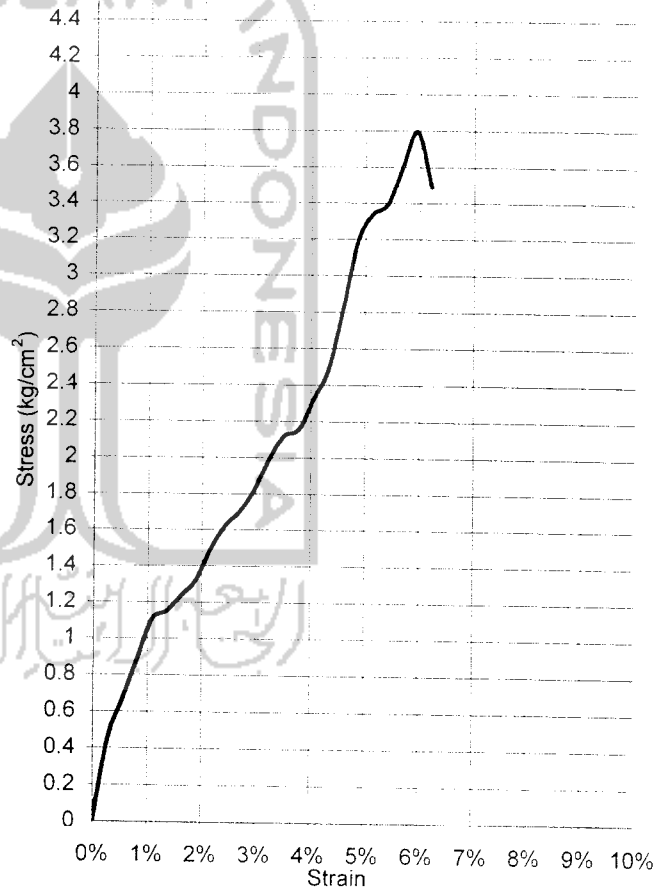

qu =	3.79388 kg/cm ²
α =	62 °
Angle Of Internal friction, φ =	34 °
Cohesion =	1.009 kg/cm ²

Diperiksa Oleh :

Dr. Ir. Edy Purwanto, CES, DEA

UNCONFINED COMPRESSION TEST

Proyek : Tugas Akhir
 Location : Cepagan, Pekalongan, Jawa Tengah
 Depth : - 1,20 meter

Date : September 2006
 Tested by : Purwadi
 Kode : Lempung + karbid 3% (2)
 3hari

data	
m	3.7
m ²)	10.7521
m)	7.45
i ³)	80.0625
	147.06
tit wt (gr/cm ³)	1.84

Water Content	
Wt Container (cup), gr	
Wt of Cup + Wet soil, gr	
Wt of Cup + Dry soil, gr	
Water Content %	
Average water content %	27.71

LRC = 0.5083 kg/div

ation iding 0 ⁻²)	Load dial (unit)	Unit Strain ($\Delta L/L_0$),	Total load on sample (kg)	Sample stress (kg/cm ²)
	0	0.00%	0	0
	20	0.27%	1.0166	0.094295
	40	0.54%	3.0498	0.282124
	60	0.81%	5.5913	0.515831
	80	1.07%	9.1494	0.841803
	100	1.34%	14.7407	1.352558
	120	1.61%	17.7905	1.627955
	140	1.88%	21.3486	1.948216
	160	2.15%	25.9233	2.359219
	180	2.42%	32.5312	2.952466
	200	2.68%	38.6308	3.496408
	220	2.95%	43.2055	3.899669
	240	3.22%	44.7304	4.026136
	260	3.49%	45.2387	4.060592
	280	3.76%	42.1889	3.776311

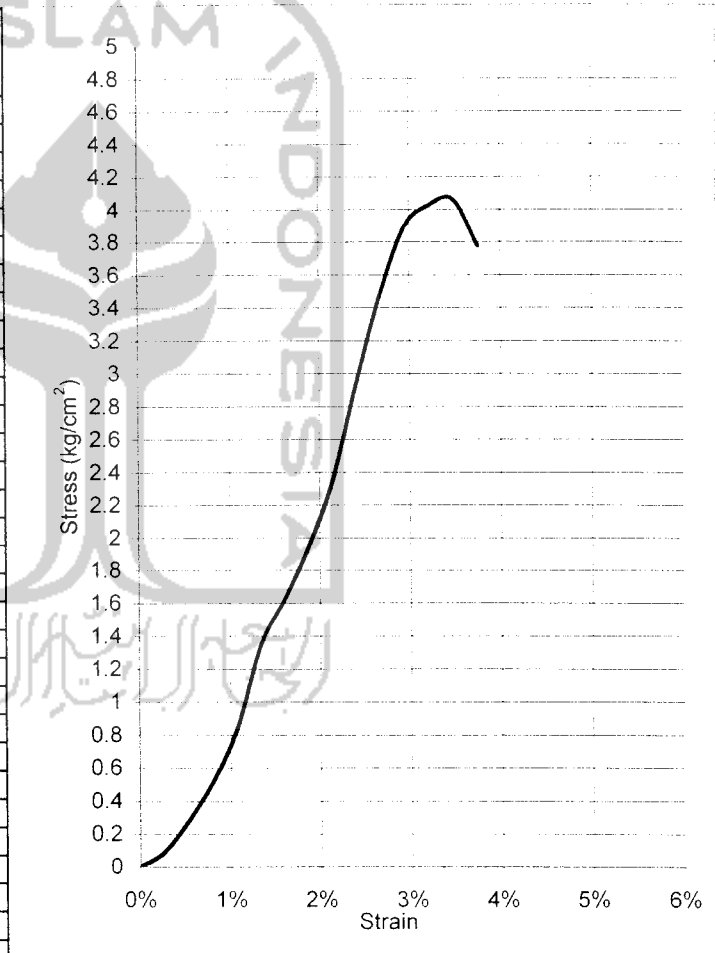

qu =	4.06059 kg/cm2
α =	62.5 °
Angle Of Internal friction, ϕ =	35 °
Cohesion =	1.057 kg/cm ²

Diperiksa Oleh :



LABORATORIUM MEKANIKA TANAH
 JURUSAN TEKNIK SIPIL-FTSP
 UNIVERSITAS ISLAM INDONESIA

UNCONFINED COMPRESSION TEST

Proyek : Tugas Akhir
 Location : Cepagan, Pekalongan, Jawa Tengah
 Depth : - 1,20 meter

Date : September 2006
 Tested by : Purwadi
 Kode : Lempung + Karbid 3% (1) 7hari

data	
n)	
n ²)	11.3411
m)	
)	85.0155
it wt (gr/cm ³)	1.76

Water Content	
Wt Container (cup), gr	
Wt of Cup + Wet soil, gr	
Wt of Cup + Dry soil, gr	
Water Content %	
Average water content %	27.71

LRC = 0.5083 kg/div

ation ding) ²)	Load dial (unit)	Unit Strain (ΔL/Lo)	Total load on sample (kg)	Sample stress (kg/cm ²)
0	0	0.00%	0	0
20	2	0.27%	1.0166	0.089399
40	11	0.53%	5.5913	0.490381
60	25	0.80%	12.7075	1.111513
80	39	1.07%	19.8237	1.7293
100	56	1.33%	28.4648	2.476404
120	68	1.60%	34.5644	2.998935
140	78	1.87%	39.6474	3.430632
160	84	2.13%	42.6972	3.684488
180	89	2.40%	45.2387	3.893165
200	92	2.67%	46.7636	4.0134
220	88	2.93%	44.7304	3.828387

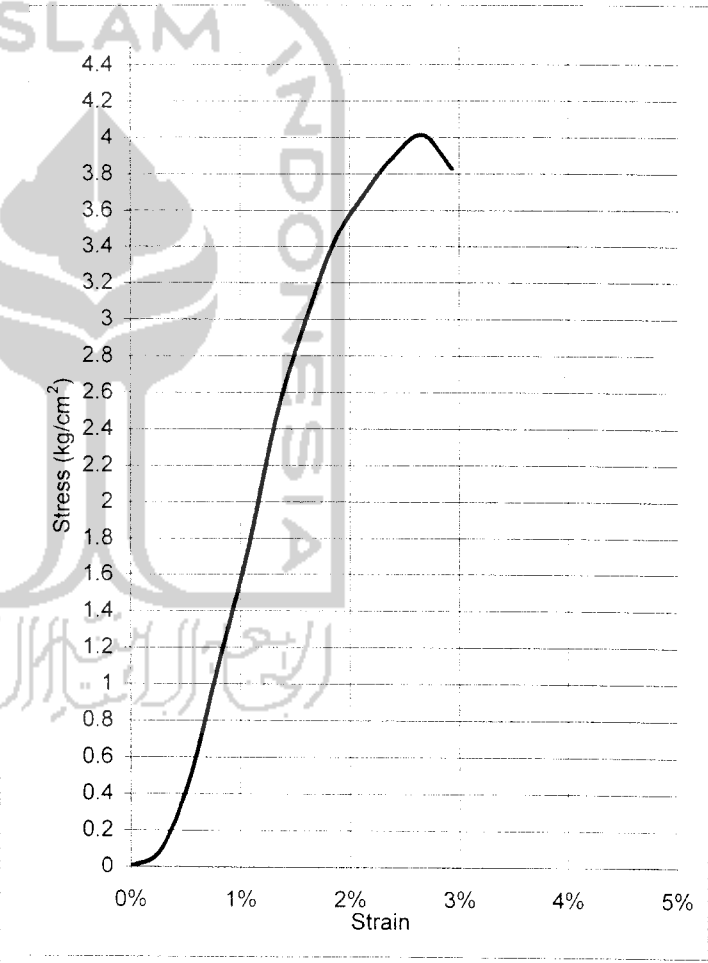

qu =	4.01340 kg/cm ²
α =	64 °
Angle Of Internal friction, φ =	38 °
Cohesion =	0.979 kg/cm ²

Diperiksa Oleh :
Edy
 Dr. Ir. Edy Purwanto, CES, DEA

LABORATORIUM MEKANIKA TANAH

JURUSAN TEKNIK SIPIL-FTSP

UNIVERSITAS ISLAM INDONESIA

UNCONFINED COMPRESSION TEST

Proyek : Tugas Akhir
 Location : Cepagan, Pekalongan, Jawa Tengah
 Depth : - 1,20 meter

Date : September 2006
 Tested by : Purwadi
 Kode : Lempung + karbid 3% (2) 7hari

data	
n)	
n ²)	11.3411
m)	
)	84.4487
t wt (gr/cm ³)	1.77

Water Content	
Wt Container (cup), gr	
Wt of Cup + Wet soil, gr	
Wt of Cup + Dry soil, gr	
Water Content %	
Average water content %	27.71

LRC = 0.5083 kg/div

ation ling (²)	Load dial (unit)	Unit Strain ($\Delta L/L_0$),	Total load on sample (kg)	Sample stress (kg/cm ²)
0	0	0.00%	0	0
20	5	0.27%	2.5415	0.223494
40	10	0.54%	5.083	0.445785
60	15	0.81%	7.6245	0.666872
80	22	1.07%	11.1826	0.975432
100	28	1.34%	14.2324	1.23809
120	38	1.61%	19.3154	1.675693
140	46	1.88%	23.3818	2.022935
160	64	2.15%	32.5312	2.806818
180	78	2.42%	39.6474	3.411425
200	85	2.68%	43.2055	3.707351
220	88	2.95%	44.7304	3.82761
240	85	3.22%	43.2055	3.686897
260	81	3.49%	41.1723	3.50365

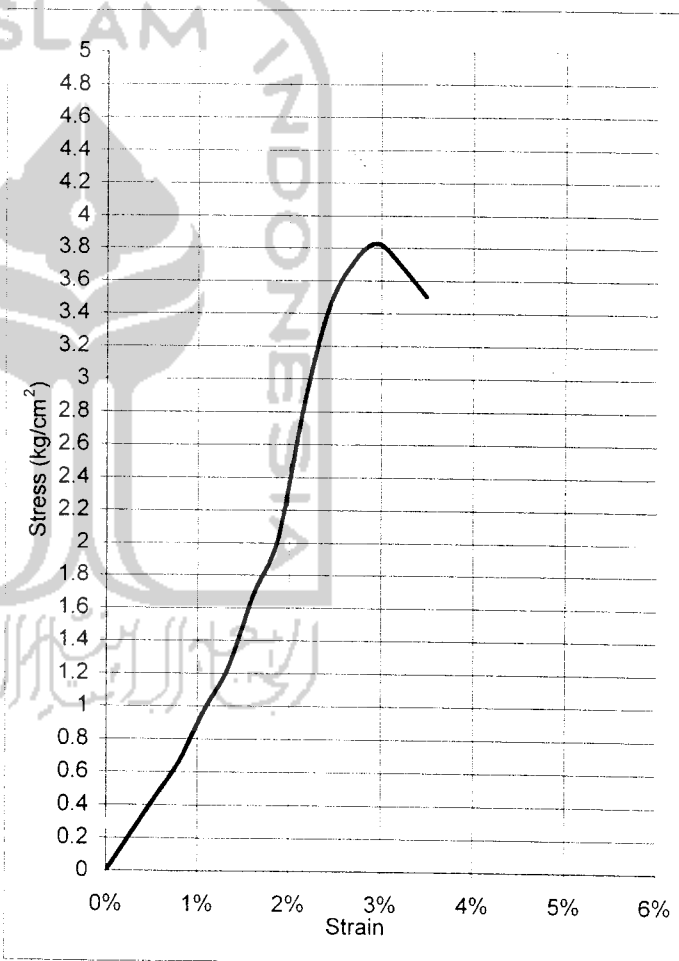

qu = 3.82761 kg/cm²
 α = 64.5 °
 Angle Of Internal friction, ϕ = 39 °
 Cohesion = 0.913 kg/cm²

Diperiksa Oleh :

 Dr. Ir. Edy Purwanto, CES, DEA



LABORATORIUM MEKANIKA TANAH
JURUSAN TEKNIK SIPIL-FTSP
UNIVERSITAS ISLAM INDONESIA

UNCONFINED COMPRESSION TEST

Proyek : Tugas Akhir
 Location : Cepagan, Pekalongan, Jawa Tengah
 Depth : - 1,20 meter

Date : September 2006
 Tested by : Purwadi
 Kode : Lempung + Karbid 3% (1) 14hari

data	
n)	
n ²)	11.3411
m)	
i)	83.882
t wt (gr/cm ³)	1.76

Water Content	
Wt Container (cup), gr	
Wt of Cup + Wet soil, gr	
Wt of Cup + Dry soil, gr	
Water Content %	
Average water content %	27.71

LRC = 0.5083 kg/div

ation ling (⁻²)	Load dial (unit)	Unit Strain (ΔL/Lo)	Total load on sample (kg)	Sample stress. (kg/cm ²)
0	0	0.00%	0	0
20	24	0.27%	12.1992	1.072751
40	58	0.54%	29.4814	2.585456
60	72	0.81%	36.5976	3.20081
80	85	1.08%	43.2055	3.768438
100	90	1.35%	45.747	3.979208
120	92	1.62%	46.7636	4.056491
140	90	1.89%	45.747	3.957405
160	85	2.16%	43.2055	3.727252

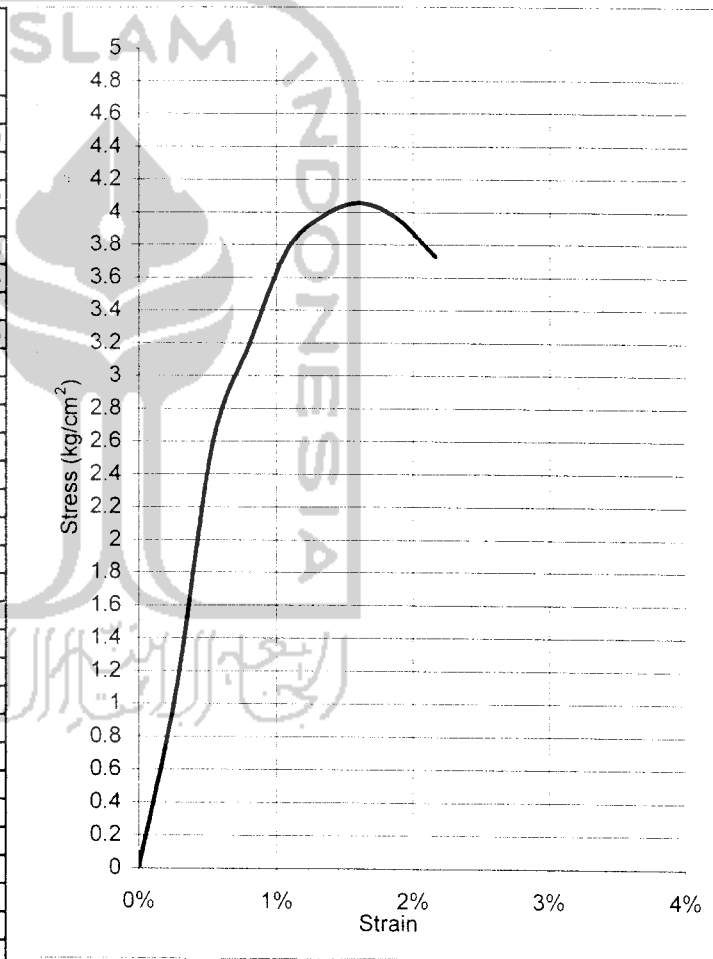

qu =	4.05649 kg/cm ²
α =	62 °
Angle Of Internal friction, φ =	34 °
Cohesion =	1.078 kg/cm ²

Diperiksa Oleh :

Dr. Ir. Edy Purwanto, CES, DEA



LABORATORIUM MEKANIKA TANAH
JURUSAN TEKNIK SIPIL-FTSP
UNIVERSITAS ISLAM INDONESIA

UNCONFINED COMPRESSION TEST

Proyek : Tugas Akhir
 Location : Cepagan, Pekalongan, Jawa Tengah
 Depth :- 1,20 meter

Date : September 2006
 Tested by : Purwadi
 Kode : Lempung + karbid 3% (2) 14hari

data	
n)	
r ²)	11.3411
m)	
)	84.4487
wt (gr/cm ³)	1.76

Water Content	
Wt Container (cup), gr	
Wt of Cup + Wet soil, gr	
Wt of Cup + Dry soil, gr	
Water Content %	
Average water content %	27.71

LRC = 0.5083 kg/div

ation ling (²)	Load dial (unit)	Unit Strain ($\Delta L/L_0$),	Total load on sample (kg)	Sample stress ² (kg/cm ²)
0	0	0.00%	0	0
20	14	0.27%	7.1162	0.625783
40	30	0.54%	15.249	1.337354
60	45	0.81%	22.8735	2.000616
80	62	1.07%	31.5146	2.748944
100	74	1.34%	37.6142	3.272094
120	82	1.61%	41.6806	3.615968
140	88	1.88%	44.7304	3.869963
160	89	2.15%	45.2387	3.903231
180	90	2.42%	45.747	3.936259
200	85	2.68%	43.2055	3.707351

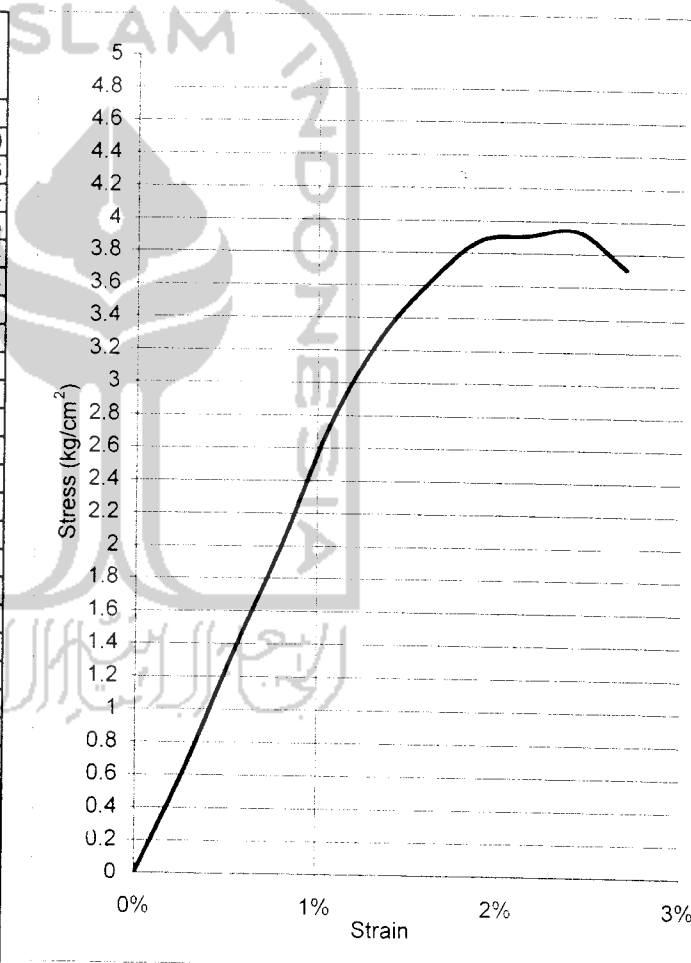

qu =	3.93626 kg/cm ²
α =	63 °
Angle Of Internal friction, ϕ =	36 °
Cohesion =	1.003 kg/cm ²

Diperiksa Oleh :

Dr. Ir. Edy Purwanto, CES, DEA



LAMPIRAN 10

Pengujian Tekan Bebas Tanah + Karbid 4.5%



LABORATORIUM MEKANIKA TANAH
JURUSAN TEKNIK SIPIL-FTSP
UNIVERSITAS ISLAM INDONESIA

UNCONFINED COMPRESSION TEST

Proyek : Tugas Akhir
 Location : Cepagan, Pekalongan, Jawa Tengah
 Depth :- 1,20 meter

Date : September 2006
 Tested by : Purwadi
 Kode : Lempung + Karbid 4,5% (1) 3hari

Volume data	
(cm)	
(cm ²)	11.3411
(cm)	
(m ³)	85.0155
Unit wt (gr/cm ³)	1.74

Water Content	
Wt Container (cup), gr	
Wt of Cup + Wet soil, gr	
Wt of Cup + Dry soil, gr	
Water Content %	
Average water content %	27.71

LRC = 0.5083 kg/div

Load increment (kg)	Load dial (unit)	Unit Strain ($\Delta L/L_0$)	Total load on sample (kg)	Sample stress (kg/cm ²)
0	0	0.00%	0	0
20	10	0.27%	5.083	0.446996
40	16	0.53%	8.1328	0.713281
60	21	0.80%	10.6743	0.933671
80	25	1.07%	12.7075	1.108525
100	29	1.33%	14.7407	1.282424
120	32	1.60%	16.2656	1.411264
140	37	1.87%	18.8071	1.627351
160	39.6	2.13%	20.12868	1.736973
180	42	2.40%	21.3486	1.837224
200	45	2.67%	22.8735	1.963076
220	47	2.93%	23.8901	2.044707
240	49.5	3.20%	25.16085	2.147552
260	52	3.47%	26.4316	2.249799
280	48	3.73%	24.3984	2.071001

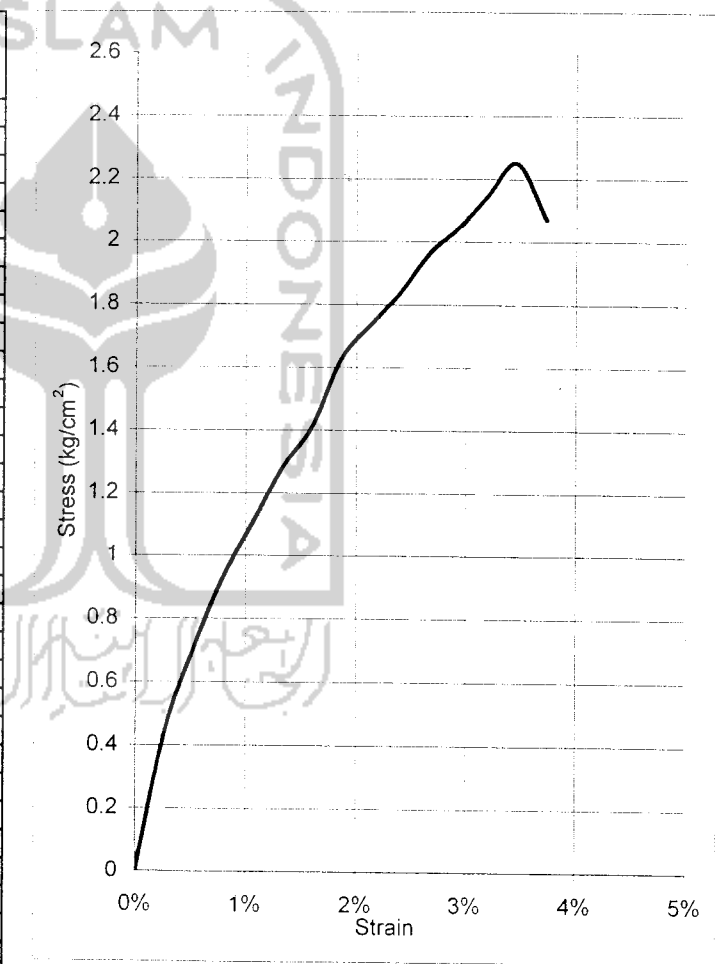

qu = 2.24980 kg/cm²
 α = 61.5°
 Angle Of Internal friction, ϕ = 33°
 Cohesion = 0.611 kg/cm²

Diperiksa Oleh:

Dr. Ir. Edy Purwanto, CES, DEA



LABORATORIUM MEKANIKA TANAH
JURUSAN TEKNIK SIPIL-FTSP
UNIVERSITAS ISLAM INDONESIA

UNCONFINED COMPRESSION TEST

Proyek : Tugas Akhir
 Location : Cepagan, Pekalongan, Jawa Tengah
 Depth : - 1,20 meter

Date : September 2006
 Tested by : Purwadi
 Kode : Lempung + karbid 4,5% (2) 3hari

data	
m)	
m ²)	10.7521
m)	
m ³)	80.0625
it wt (gr/cm ³)	1.86

Water Content	
Wt Container (cup), gr	
Wt of Cup + Wet soil, gr	
Wt of Cup + Dry soil, gr	
Water Content %	
Average water content %	27.71

LRC = 0.5083 kg/div

ation ding (m ⁻²)	Load dial (unit)	Unit Strain (ΔL/Lo)	Total load on sample (kg)	Sample stress (kg/cm ²)
0	0	0.00%	0	0
20	2	0.27%	1.0166	0.094295
40	5	0.54%	2.5415	0.235103
60	8	0.81%	4.0664	0.37515
80	12	1.07%	6.0996	0.561202
100	15	1.34%	7.6245	0.699599
120	18	1.61%	9.1494	0.837234
140	21	1.88%	10.6743	0.974108
160	24	2.15%	12.1992	1.110221
180	30	2.42%	15.249	1.383968
200	36	2.68%	18.2988	1.656193
220	42.5	2.95%	21.60275	1.949834
240	49	3.22%	24.9067	2.241826
260	53.5	3.49%	27.19405	2.440918
280	47	3.76%	23.8901	2.138393

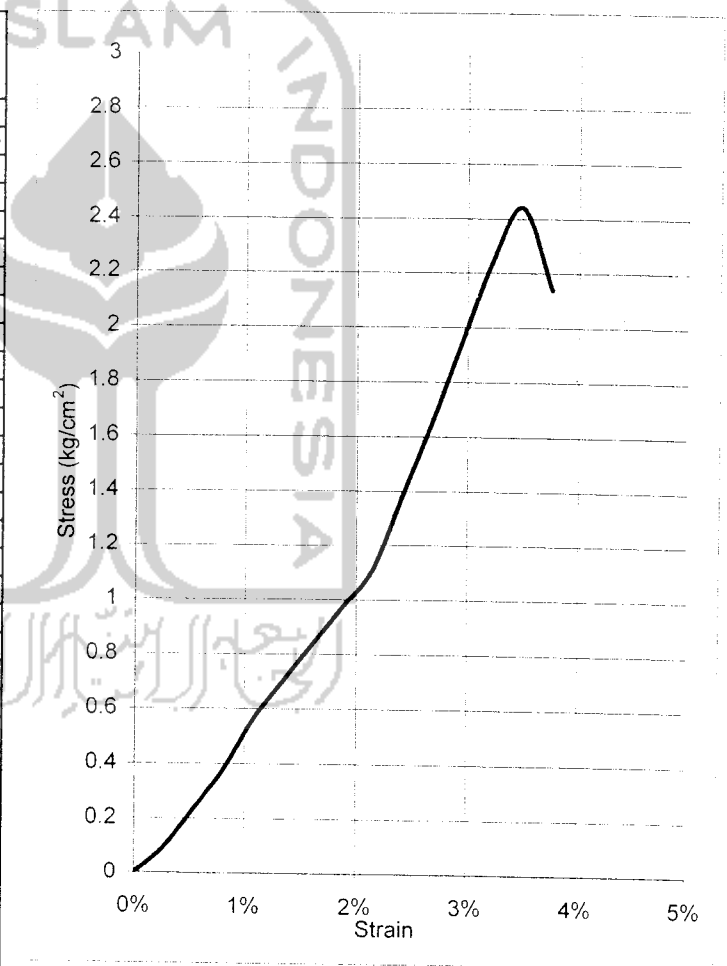

qu = 2.44092 kg/cm²
 α = 62 °
 Angle Of Internal friction, φ = 34 °
 Cohesion = 0.649 kg/cm²

Diperiksa Oleh :

Dr. Ir. Eddy Purwanto, CES, DEA



LABORATORIUM MEKANIKA TANAH
JURUSAN TEKNIK SIPIL-FTSP
UNIVERSITAS ISLAM INDONESIA

UNCONFINED COMPRESSION TEST

Proyek : Tugas Akhir
 Location : Cepagan, Pekalongan, Jawa Tengah
 Depth : - 1,20 meter

Date : September 2006
 Tested by : Purwadi
 Kode : Lempung + Karbid 4,5% (1) 7hari

data	
n)	
r ²)	11.3411
n)	
)	83.882
wt (gr/cm ³)	1.73

Water Content	
Wt Container (cup), gr	
Wt of Cup + Wet soil, gr	
Wt of Cup + Dry soil, gr	
Water Content %	
Average water content %	27.71

LRC = 0.5083 kg/div

Load Dial (unit)	Unit Strain (ΔL/L ₀)	Total load on sample (kg)	Sample stress (kg/cm ²)
0	0.00%	0	0
20	0.27%	2.0332	0.178792
40	0.54%	3.5581	0.312038
60	0.81%	7.6245	0.666835
80	1.08%	11.6909	1.019695
100	1.35%	16.2656	1.41483
120	1.62%	25.9233	2.248707
140	1.89%	31.0063	2.682241
160	2.16%	34.0561	2.937952
180	2.43%	34.5644	2.973565
200	2.70%	36.0893	3.096151
220	2.97%	34.5644	2.957091

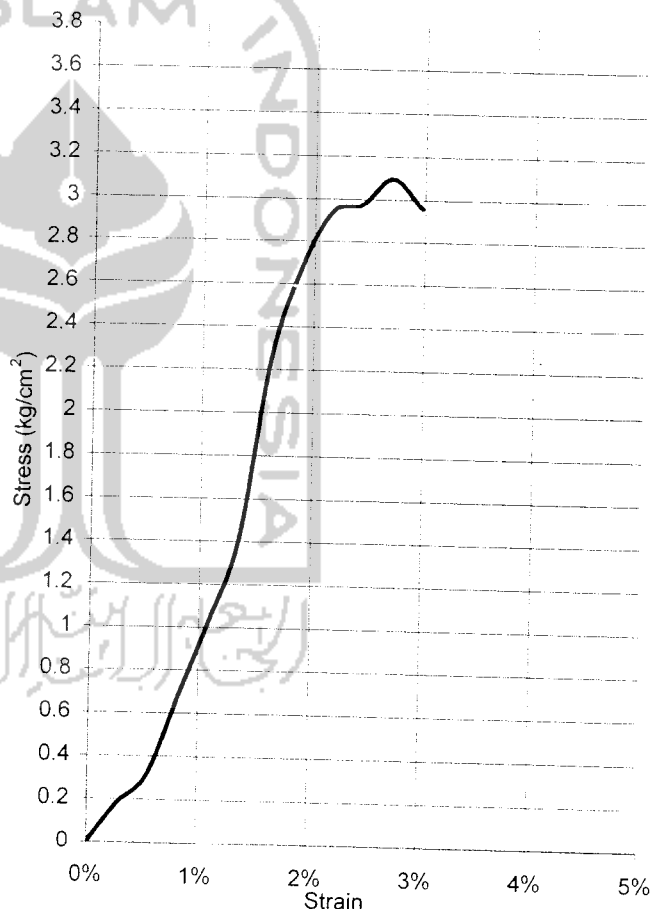

qu = 3.09615 kg/cm²
 α = 62°
 Angle Of Internal friction, φ = 34°
 Cohesion = 0.823 kg/cm²

Diperiksa Oleh:

Dr. Ir. Edy Purwanto, CES, DEA



LABORATORIUM MEKANIKA TANAH

JURUSAN TEKNIK SIPIL-FTSP

UNIVERSITAS ISLAM INDONESIA

UNCONFINED COMPRESSION TEST

Proyek : Tugas Akhir
 Location : Cepagan, Pekalongan, Jawa Tengah
 Depth : - 1,20 meter

Date : September 2006
 Tested by : Purwadi
 Kode : Lempung + karbid 4,5% (2) 7hari

data	
m)	
n ²)	11.3411
m)	
3)	84.4487
it wt (gr/cm ³)	1.76

Water Content		
Wt Container (cup), gr		
Wt of Cup + Wet soil, gr		
Wt of Cup + Dry soil, gr		
Water Content %		
Average water content %		27.71

LRC = 0.5083 kg/div

ation ding) ²)	Load dial (unit)	Unit Strain (ΔL/Lo)	Total load on sample (kg)	Sample stress (kg/cm ²)
0	0	0.00%	0	0
20	2	0.27%	1.0166	0.089398
40	5	0.54%	2.5415	0.222892
60	10	0.81%	5.083	0.444581
80	15	1.07%	7.6245	0.665067
100	20	1.34%	10.166	0.88435
120	25	1.61%	12.7075	1.102429
140	31	1.88%	15.7573	1.363282
160	35	2.15%	17.7905	1.534979
180	41	2.42%	20.8403	1.793185
200	50	2.68%	25.415	2.180795
220	57	2.95%	28.9731	2.479248
240	61	3.22%	31.0063	2.64589
260	68	3.49%	34.5644	2.941336
280	62	3.76%	31.5146	2.674346

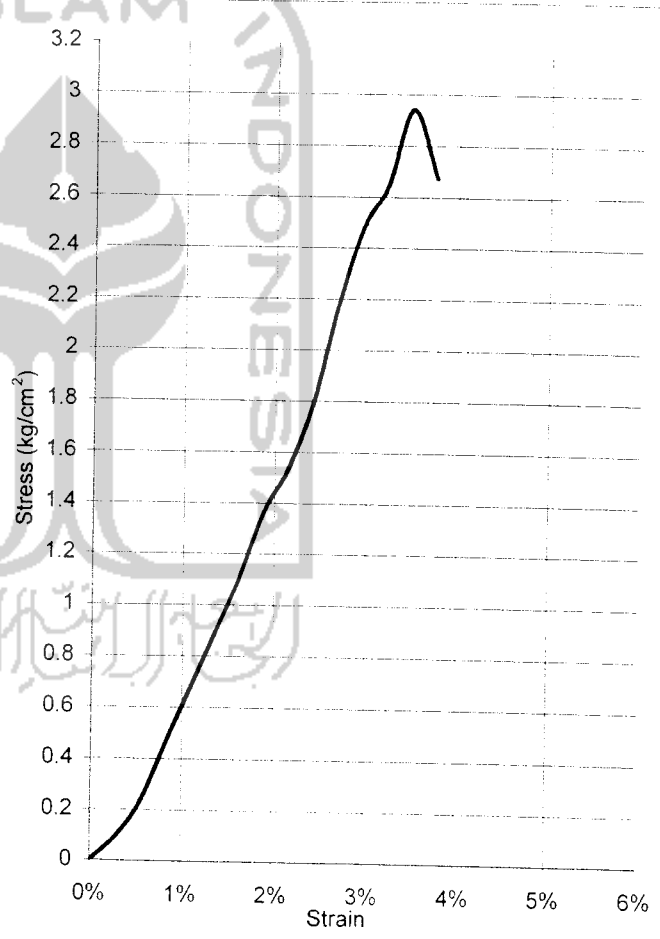

qu = 2.94134 kg/cm²
 α = 62.5 °
 Angle Of Internal friction, φ = 35 °
 Cohesion = 0.766 kg/cm²

Diperiksa Oleh :

Dr. Ir. Emy Purwanto, CES, DEA



LABORATORIUM MEKANIKA TANAH
JURUSAN TEKNIK SIPIL-FTSP
UNIVERSITAS ISLAM INDONESIA

UNCONFINED COMPRESSION TEST

Proyek : Tugas Akhir
 Location : Cepagan, Pekalongan, Jawa Tengah
 Depth : - 1,20 meter

Date : September 2006
 Tested by : Purwadi
 Kode : Lempung + Karbid 4,5% (1) 14hari

data	
n)	3.8
n ²)	11.3411
n)	7.4
)	83.882
	150.09
wt (gr/cm ³)	1.79

Water Content		
Wt Container (cup), gr		
Wt of Cup + Wet soil, gr		
Wt of Cup + Dry soil, gr		
Water Content %		
Average water content %		27.71

LRC = 0.5083 kg/div

Load Dial (unit)	Unit Strain (ΔL/L ₀)	Total load on sample (kg)	Sample stress (kg/cm ²)
0	0.00%	0	0
20	0.27%	8.1328	0.715167
40	0.54%	10.166	0.891536
60	0.81%	12.1992	1.066937
80	1.08%	14.7407	1.285702
100	1.35%	17.2822	1.503257
120	1.62%	19.8237	1.719599
140	1.89%	23.8901	2.066645
160	2.16%	28.9731	2.499452
180	2.43%	34.5644	2.973565
200	2.70%	38.1225	3.270582
220	2.97%	42.6972	3.652877
240	3.24%	44.7304	3.816164
260	3.51%	48.2885	4.108215
280	3.78%	52.8632	4.484816
300	4.05%	50.83	4.30021
320	4.32%	48.2885	4.073692

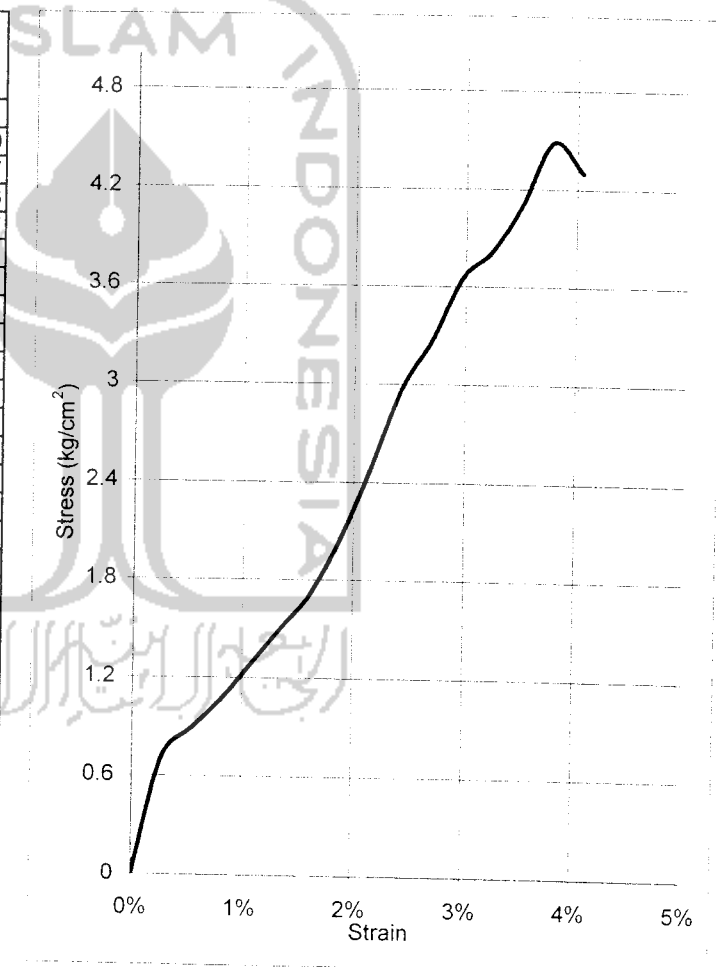

qu = 4.48482 kg/cm²
 α = 64 °
 Angle Of Internal friction, φ = 38 °
 Cohesion = 1.094 kg/cm²

Diperiksa Oleh :

Dr. Ir. Epy Purwanto, CES, DEA

UNCONFINED COMPRESSION TEST

Proyek : Tugas Akhir
Location : Cepagan, Pekalongan, Jawa Tengah
Depth : - 1,20 meter

Date : September 2006
Tested by : Purwadi
Kode : Lempung + karbid 4,5% (2) 14hari

lata	
)	
)	11.3411
)	
)	84.4487
wt (gr/cm ³)	1.79

Water Content	
Wt Container (cup), gr	
Wt of Cup + Wet soil, gr	
Wt of Cup + Dry soil, gr	
Water Content %	
Average water content %	27.71

LRC = 0.5083 kg/div

tion ng	Load dial (unit)	Unit Strain ($\Delta L/L_0$)	Total load on sample (kg)	Sample stress (kg/cm ²)
0	0	0.00%	0	0
20	12	0.27%	6.0996	0.536385
40	39	0.54%	19.8237	1.73856
60	57	0.81%	28.9731	2.534113
80	78	1.07%	39.6474	3.458349
100	90	1.34%	45.747	3.979574
120	102	1.61%	51.8466	4.497912
140	108	1.88%	54.8964	4.7495
160	108	2.15%	54.8964	4.736506
180	102	2.42%	51.8466	4.461094
200	85	2.68%	43.2055	3.707351

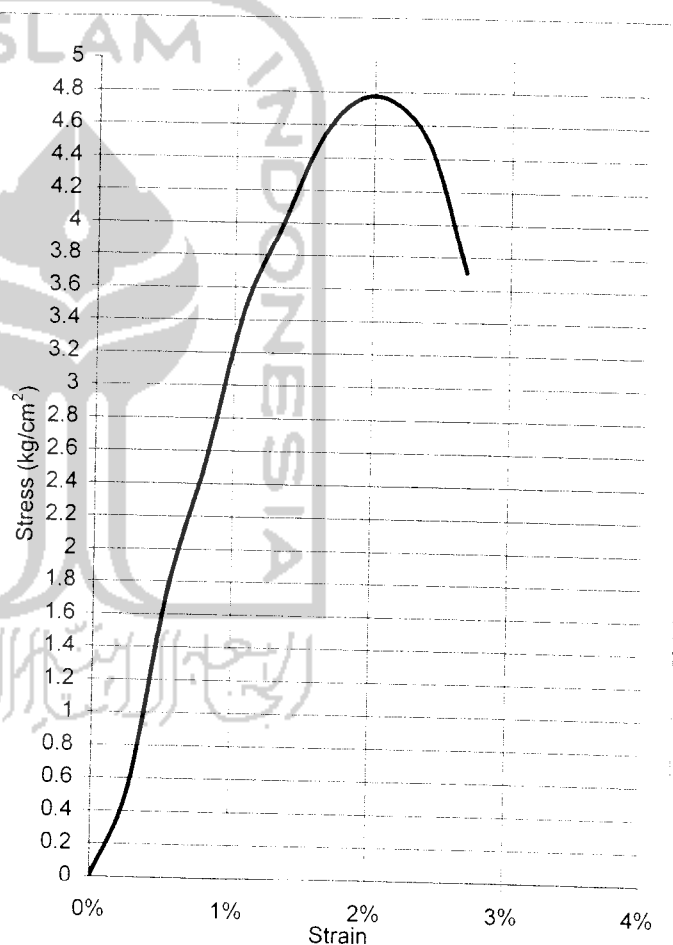

$q_u = 4.74950 \text{ kg/cm}^2$
 $\alpha = 65^\circ$
Angle Of Internal friction, $\phi = 40^\circ$
Cohesion = 1.107 kg/cm^2

Diperiksa Oleh:



Dr. Ir. Edy Purwanto, CES, DEA



LAMPIRAN 11

Pengujian Tekan Bebas Tanah + Karbid 6%



LABORATORIUM MEKANIKA TANAH
JURUSAN TEKNIK SIPIL-FTSP
UNIVERSITAS ISLAM INDONESIA

UNCONFINED COMPRESSION TEST

Proyek : Tugas Akhir
Location : Cepagan, Pekalongan, Jawa Tengah
Depth :- 1,20 meter

Date : September 2006
Tested by : Purwadi
Kode : Lempung + Karbid 6% (1) 3hari

data	
n)	
n ²)	11.3411
m)	
s)	83.882
t wt (gr/cm ³)	1.75

Water Content		
Wt Container (cup), gr		
Wt of Cup + Wet soil, gr		
Wt of Cup + Dry soil, gr		
Water Content %		
Average water content %		27.71

LRC = 0.5083 kg/div

ation ling (⁻²)	Load dial (unit)	Unit Strain ($\Delta L/L_0$)	Total load on sample (kg)	Sample stress (kg/cm ²)
0	0	0.00%	0	0
20	5	0.27%	2.5415	0.22349
40	9	0.54%	4.5747	0.401191
60	17	0.81%	8.6411	0.755747
80	22	1.08%	11.1826	0.97536
100	29	1.35%	14.7407	1.282189
120	33	1.62%	16.7739	1.455046
140	41	1.89%	20.8403	1.802818
160	45.2	2.16%	22.97516	1.982021
180	46.5	2.43%	23.63595	2.033394
200	47	2.70%	23.8901	2.049565
220	48	2.97%	24.3984	2.087358
240	50	3.24%	25.415	2.168275
260	48	3.51%	24.3984	2.07573

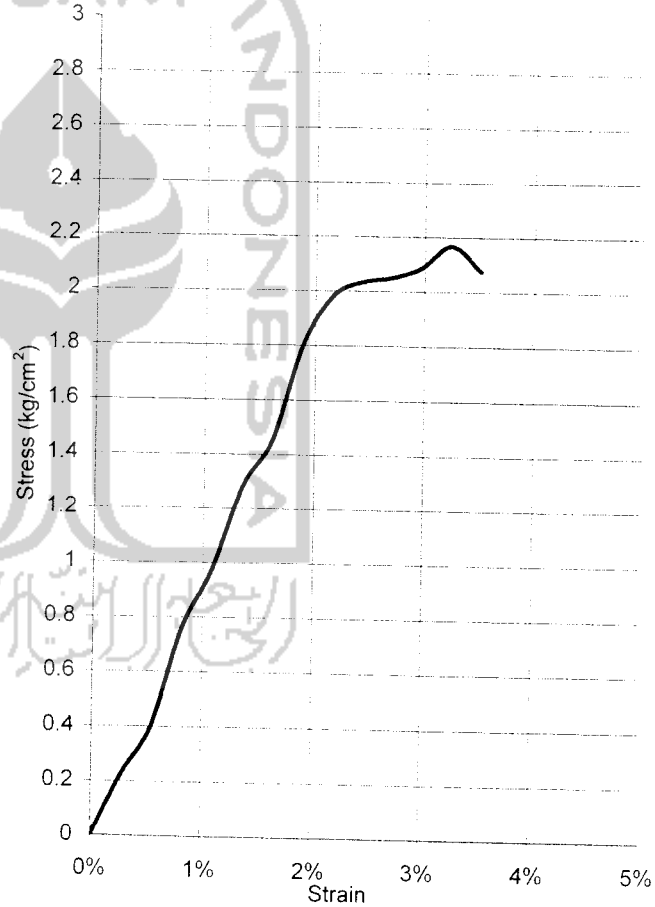

qu = 2.16827 kg/cm²
 α = 61°
Angle Of Internal friction, ϕ = 32°
Cohesion = 0.601 kg/cm²

Diperiksa Oleh :

Dr. Ir. Egi Purwanto, CES, DEA

UNCONFINED COMPRESSION TEST

Proyek : Tugas Akhir
 Location : Cepagan, Pekalongan, Jawa Tengah
 Depth :- 1,20 meter

Date : September 2006
 Tested by : Purwadi
 Kode : Lempung + karbid 6% (2) 3hari

data	
n)	
n ²)	11.3411
m)	
)	84.4487
t wt (gr/cm ³)	1.74

Water Content	
Wt Container (cup), gr	
Wt of Cup + Wet soil, gr	
Wt of Cup + Dry soil, gr	
Water Content %	
Average water content %	27.71

LRC = 0.5083 kg/div

ation ling (²)	Load dial (unit)	Unit Strain ($\Delta L/L_0$)	Total load on sample (kg)	Sample stress: (kg/cm ²)
0	0	0.00%	0	0
20	5	0.27%	2.5415	0.223494
40	11	0.54%	5.5913	0.490363
60	19	0.81%	9.6577	0.844704
80	25	1.07%	12.7075	1.108445
100	32	1.34%	16.2656	1.41496
120	39	1.61%	19.8237	1.71979
140	45	1.88%	22.8735	1.978958
160	47	2.15%	23.8901	2.061257
180	49.5	2.42%	25.16085	2.164943
200	51.5	2.68%	26.17745	2.246218
220	49	2.95%	24.9067	2.131283

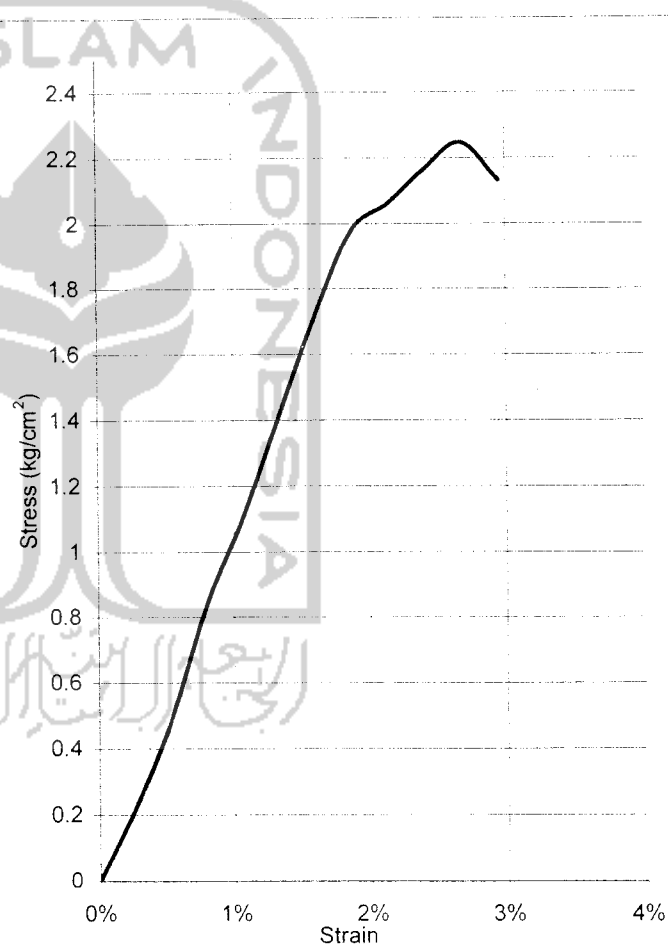

q_u	=	2.24622 kg/cm ²
α	=	60 °
Angle Of Internal friction, ϕ	=	30 °
Cohesion	=	0.648 kg/cm ²

Diperiksa Oleh :

Dr. Ir. Eddy Purwanto, CES, DEA



LABORATORIUM MEKANIKA TANAH
JURUSAN TEKNIK SIPIL-FTSP
UNIVERSITAS ISLAM INDONESIA

UNCONFINED COMPRESSION TEST

Proyek : Tugas Akhir
 Location : Cepagan, Pekalongan, Jawa Tengah
 Depth : - 1,20 meter

Date : September 2006
 Tested by : Purwadi
 Kode : Lempung + Karbid 6% (1) 7hari

data	
m)	
n)	11.3411
o)	83.882
p)	
qt wt (gr/cm ³)	1.74

Water Content	
Wt Container (cup), gr	
Wt of Cup + Wet soil, gr	
Wt of Cup + Dry soil, gr	
Water Content %	
Average water content %	27.71

LRC = 0.5083 kg/div

Load dial (unit)	Unit Strain (ΔL/Lo)	Total load on sample (kg)	Sample stress (kg/cm ²)
0	0.00%	0	0
20	0.27%	2.0332	0.178792
40	0.54%	5.083	0.445768
60	0.81%	9.1494	0.800202
80	1.08%	10.6743	0.931026
100	1.35%	14.2324	1.237976
120	1.62%	17.2822	1.499138
140	1.89%	23.3818	2.022673
160	2.16%	26.4316	2.280201
180	2.43%	28.9731	2.492547
200	2.70%	30.498	2.616466
220	2.97%	32.0229	2.739658
240	3.24%	33.0395	2.818757
260	3.51%	34.0561	2.897372
280	3.78%	32.5312	2.759887

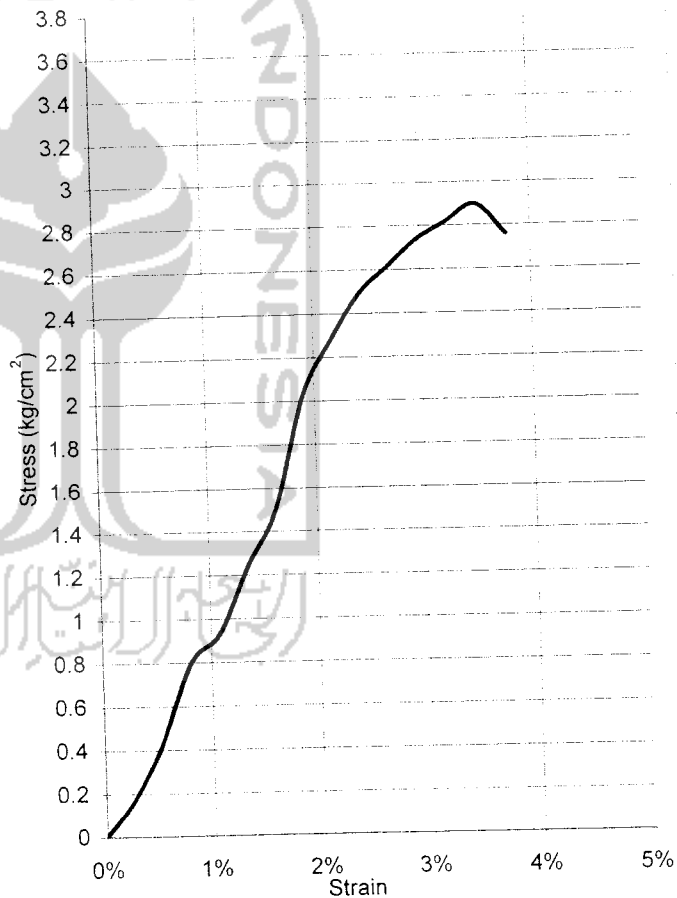

qu = 2.89737 kg/cm²
 α = 62°
 Angle Of Internal friction, ϕ = 34°
 Cohesion = 0.770 kg/cm²

Diperiksa Oleh :

Dr. Ir. Edy Purwanto, CES, DEA



LABORATORIUM MEKANIKA TANAH

JURUSAN TEKNIK SIPIL-FTSP

UNIVERSITAS ISLAM INDONESIA

UNCONFINED COMPRESSION TEST

Proyek : Tugas Akhir
Location : Cepagan, Pekalongan, Jawa Tengah
Depth : - 1,20 meter

Date : September 2006
Tested by : Purwadi
Kode : Lempung + Karbid 6% (2) 7hari

Initial data	
Initial diameter (cm)	
Initial cross-sectional area (cm ²)	11.3411
Initial height (cm)	
Initial volume (cm ³)	83.882
Initial unit weight (gr/cm ³)	1.74

Water Content	
Wt Container (cup), gr	
Wt of Cup + Wet soil, gr	
Wt of Cup + Dry soil, gr	
Water Content %	
Average water content %	27.71

LRC = 0.5083 kg/div

Load increment (kg)	Load dial (unit)	Unit Strain ($\Delta L/L_0$)	Total load on sample (kg)	Sample stress (kg/cm ²)
0	0	0.00%	0	0
20	5	0.27%	2.5415	0.22349
40	16	0.54%	8.1328	0.713229
60	24	0.81%	12.1992	1.066937
80	28	1.08%	14.2324	1.241368
100	35	1.35%	17.7905	1.54747
120	47	1.62%	23.8901	2.072338
140	52	1.89%	26.4316	2.2865
160	62	2.16%	31.5146	2.718702
180	64	2.43%	32.5312	2.798649
200	66	2.70%	33.5478	2.878112
220	67	2.97%	34.0561	2.913604
240	68	3.24%	34.5644	2.948854
260	69	3.51%	35.0727	2.983861
280	55	3.78%	33.0395	2.80301

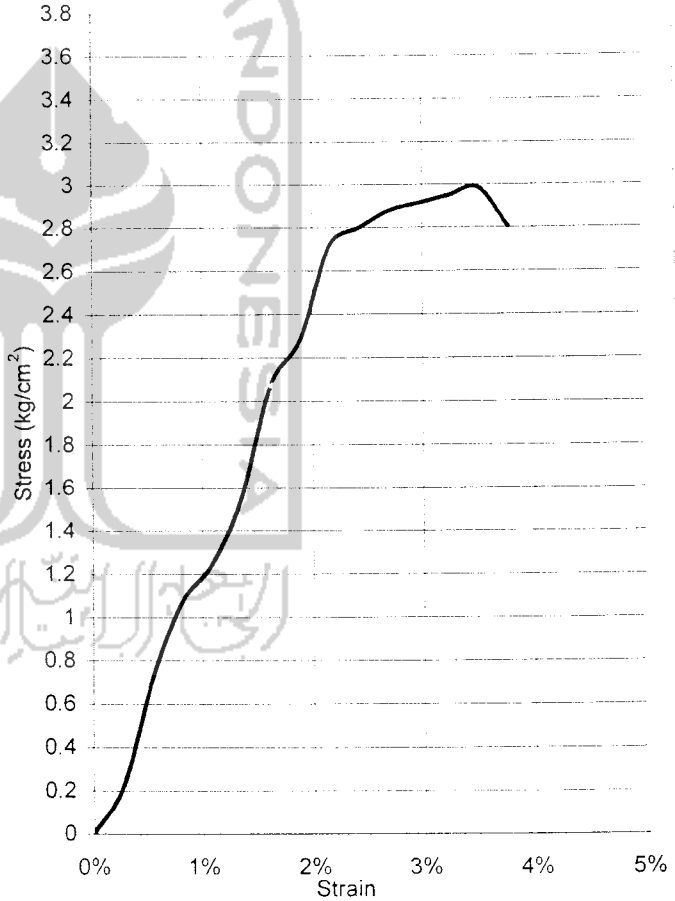

$q_u = 2.98386 \text{ kg/cm}^2$
 $\alpha = 62^\circ$
Angle Of Internal friction, $\phi = 34^\circ$
Cohesion = 0.793 kg/cm^2

Diperiksa Oleh :

Dr. Ir. Edy Purwanto, CES, DEA



LABORATORIUM MEKANIKA TANAH
JURUSAN TEKNIK SIPIL-FTSP
UNIVERSITAS ISLAM INDONESIA

UNCONFINED COMPRESSION TEST

Proyek : Tugas Akhir
 Location : Cepagan, Pekalongan, Jawa Tengah
 Depth : 1,20 meter

Date : September 2006
 Tested by : Purwadi
 Kode : Lempung + Karbid 6% (1) 14hari

data	
1)	
2)	11.3411
3)	
	83.882
wt (g/cm ³)	1,76

Water Content	
Wt Container (cup), gr	
Wt of Cup + Wet soil, gr	
Wt of Cup + Dry soil, gr	
Water Content %	
Average water content %	27,71

LRC = 0.5083 kg/div

Load (kg)	Load dial (unit)	Unit Strain (ΔL/Lo)	Total load on sample (kg)	Sample stress (kg/cm ²)
0	0	0.00%	0	0
20	15	0.27%	7.6245	0.670469
40	24	0.54%	12.1992	1.069844
60	31	0.81%	15.7573	1.378126
80	38	1.08%	19.3154	1.684713
100	50	1.35%	25.415	2.210671
120	59	1.62%	29.9897	2.601445
140	74	1.89%	37.6142	3.253866
160	85	2.16%	43.2055	3.727252
180	84	2.43%	42.6972	3.673227
200	74	2.70%	37.6142	3.226974

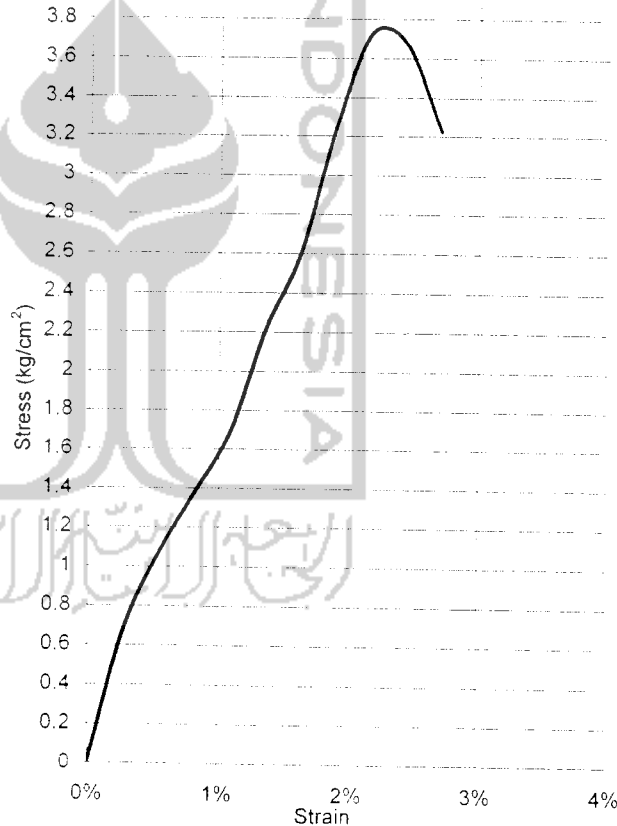

qu = 3,72725 kg/cm²
 α = 65 °
 Angle Of Internal friction, φ = 40 °
 Cohesion = 0,869 kg/cm²

Diperiksa Oleh :

Dr. Ir. Epy Purwanto, CES, DEA



LABORATORIUM MEKANIKA TANAH
JURUSAN TEKNIK SIPIL-FTSP
UNIVERSITAS ISLAM INDONESIA

UNCONFINED COMPRESSION TEST

Proyek : Tugas Akhir
 Location : Cepagan, Pekalongan, Jawa Tengah
 Depth : - 1,20 meter

Date : September 2006
 Tested by : Purwadi
 Kode : Lempung + karbid 6% (2)
 14hari

data	
n)	
n ²)	11.3411
m)	
s ³)	84.4487
it wt (gr/cm ³)	1.77

Water Content	
Wt Container (cup), gr	
Wt of Cup + Wet soil, gr	
Wt of Cup + Dry soil, gr	
Water Content %	
Average water content %	27.71

LRC = 0.5083 kg/div

ation ting (r ²)	Load dial (unit)	Unit Strain (ΔL/Lo)	Total load on sample (kg)	Sample stress (kg/cm ²)
0	0	0.00%	0	0
20	9	0.27%	4.5747	0.402289
40	16	0.54%	8.1328	0.713255
60	24	0.81%	12.1992	1.066995
80	29	1.07%	14.7407	1.285797
100	37	1.34%	18.8071	1.636047
120	50	1.61%	25.415	2.204859
140	64	1.88%	32.5312	2.814519
160	74	2.15%	37.6142	3.245383
180	79	2.42%	40.1557	3.455161
200	79	2.68%	40.1557	3.445656
220	73	2.95%	37.1059	3.175177

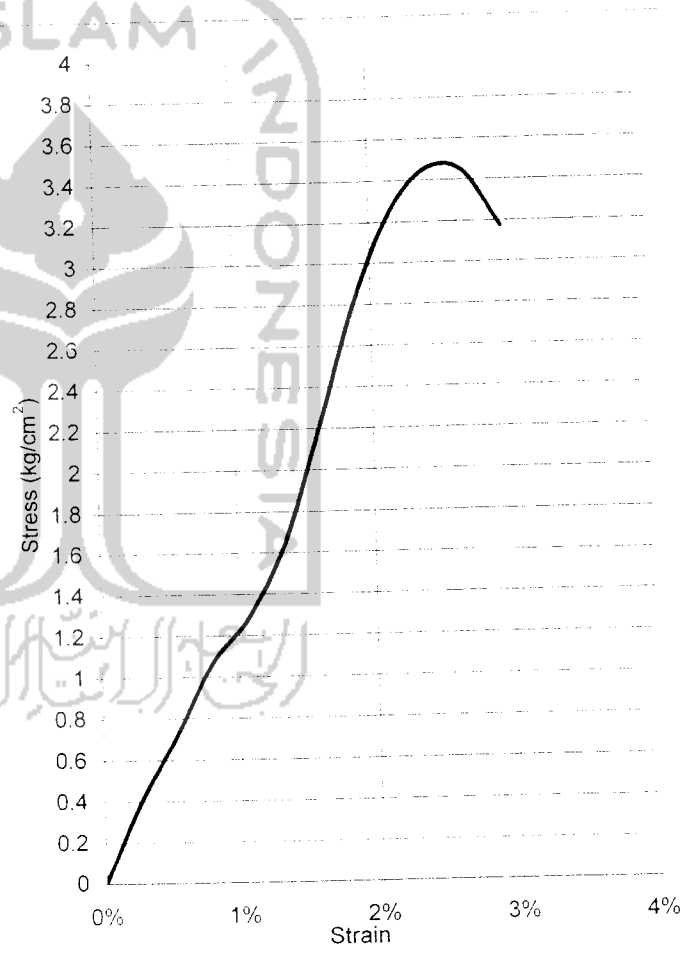

qu =	3.45516 kg/cm ²
α =	64 °
Angle Of Internal friction, φ =	38 °
Cohesion =	0.843 kg/cm ²

Diperiksa Oleh :

Dr. Ir. Epy Purwanto, CES, DEA



LAMPIRAN 12
Pengujian Tekan Bebas Tanah + Karbid 7.5%



LABORATORIUM MEKANIKA TANAH

JURUSAN TEKNIK SIPIL-FTSP

UNIVERSITAS ISLAM INDONESIA

UNCONFINED COMPRESSION TEST

Proyek : Tugas Akhir
 Location : Cepagan, Pekalongan, Jawa Tengah
 Depth :- 1,20 meter

Date : September 2006
 Tested by : Purwadi
 Kode : Lempung + Karbid 7,5% (1) 3hari

data	
m	3.8
m ²	11.3411
cm	7.4
m ³	83.882
	144.32
unit wt (gr/cm ³)	1.72

Water Content	
Wt Container (cup), gr	
Wt of Cup + Wet soil, gr	
Wt of Cup + Dry soil, gr	
Water Content %	
Average water content %	27.71

LRC = 0.5083 kg/div

Load (kg)	Load dial (unit)	Unit Strain ($\Delta L/L_0$)	Total load on sample (kg)	Sample stress (kg/cm ²)
0	0	0.00%	0	0
20	7	0.27%	3.5581	0.312886
40	12	0.54%	6.0996	0.534922
60	18	0.81%	9.1494	0.800202
80	24	1.08%	12.1992	1.064029
100	31	1.35%	15.7573	1.370616
120	35	1.62%	17.7905	1.54323
140	37	1.89%	18.8071	1.626933
160	38.5	2.16%	19.62038	1.692611
180	40.5	2.43%	20.58615	1.77102
200	42	2.70%	21.3486	1.831526
220	38	2.97%	19.3154	1.652492

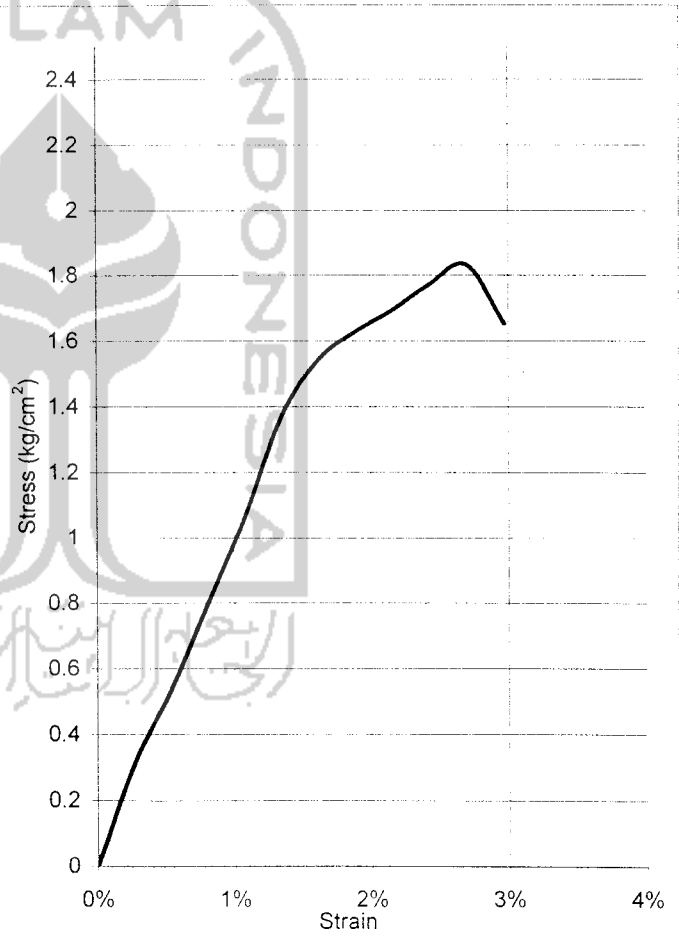

q_u	=	1.83153 kg/cm ²
α	=	60°
Angle Of Internal friction, ϕ	=	30°
Cohesion	=	0.529 kg/cm ²

Diperiksa Oleh :

Dr. Ir. Edy Purwanto, CES, DEA



LABORATORIUM MEKANIKA TANAH
JURUSAN TEKNIK SIPIL-FTSP
UNIVERSITAS ISLAM INDONESIA

UNCONFINED COMPRESSION TEST

Proyek : Tugas Akhir
 Location : Cepagan, Pekalongan, Jawa Tengah
 Depth : - 1,20 meter

Date : September 2006
 Tested by : Purwadi
 Kode : Lempung + karbid 7,5% (2) 3hari

data	
m)	3.8
m ²)	11.3411
cm)	7.45
m ³)	84.4487
	144.57
unit wt (gr/cm ³)	1.71

Water Content	
Wt Container (cup), gr	
Wt of Cup + Wet soil, gr	
Wt of Cup + Dry soil, gr	
Water Content %	
Average water content %	27.71

LRC = 0.5083 kg/div

Load dial (unit)	Unit Strain (ΔL/L ₀)	Total load on sample (kg)	Sample stress (kg/cm ²)
0	0.00%	0	0
20	0.27%	4.0664	0.35759
40	0.54%	7.1162	0.624098
60	0.81%	9.6577	0.844704
80	1.07%	12.7075	1.108445
100	1.34%	14.7407	1.282307
120	1.61%	16.2656	1.411109
140	1.88%	17.7905	1.53919
160	2.15%	19.3154	1.666548
180	2.42%	20.12868	1.731954
200	2.68%	20.8403	1.788252
220	2.95%	22.11105	1.892057
240	3.22%	20.332	1.73501

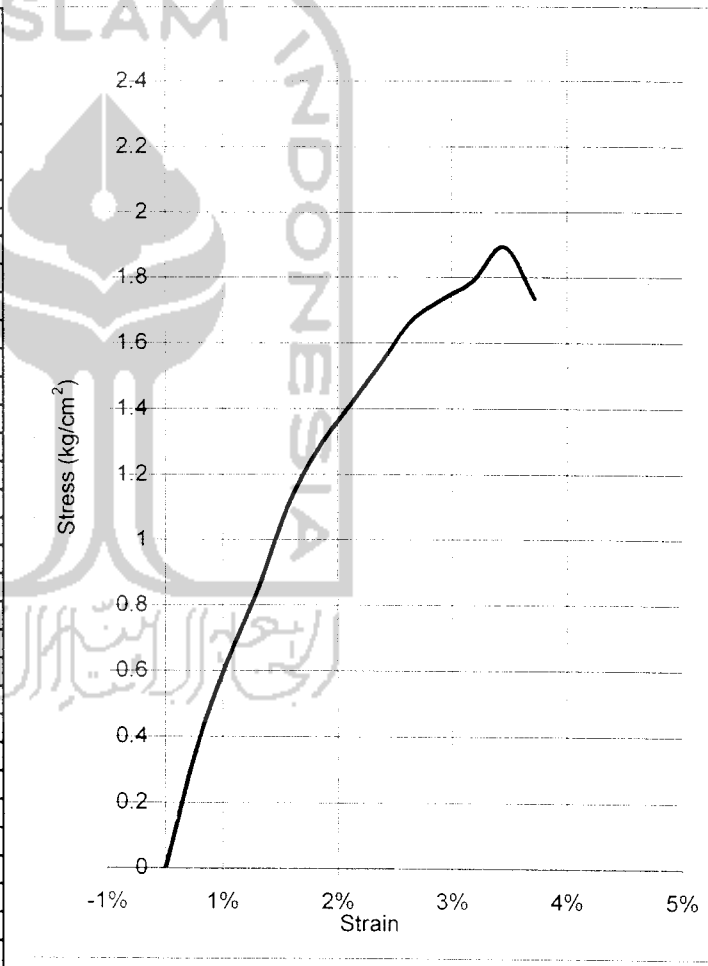

qu =	1.89206 kg/cm ²
α =	61.5 °
Angle Of Internal friction, φ =	33 °
Cohesion =	0.514 kg/cm ²

Diperiksa Oleh :

Dr. Ir. Edy Purwanto, CES, DEA



LABORATORIUM MEKANIKA TANAH
JURUSAN TEKNIK SIPIL-FTSP
UNIVERSITAS ISLAM INDONESIA

UNCONFINED COMPRESSION TEST

Proyek : Tugas Akhir
 Location : Cepagan, Pekalongan, Jawa Tengah
 Depth : - 1,20 meter

Date : September 2006
 Tested by : Purwadi
 Kode : Lempung + Karbid 7,5% (1) 7hari

data	
n)	
n ²)	11.3411
m)	
s ³)	83.882
it wt (gr/cm ³)	1.75

Water Content	
Wt Container (cup), gr	
Wt of Cup + Wet soil, gr	
Wt of Cup + Dry soil, gr	
Water Content %	
Average water content %	27.71

LRC = 0.5083 kg/div

ation ding (r ²)	Load dial (unit)	Unit Strain (ΔL/L ₀)	Total load on sample (kg)	Sample stress (kg/cm ²)
0	0	0.00%	0	0
20	6	0.27%	3.0498	0.268188
40	9	0.54%	4.5747	0.401191
60	12	0.81%	6.0996	0.533468
80	17	1.08%	8.6411	0.753688
100	19	1.35%	9.6577	0.840055
120	22	1.62%	11.1826	0.97003
140	27	1.89%	13.7241	1.187221
160	31	2.16%	15.7573	1.359351
180	38	2.43%	19.3154	1.661698
200	45	2.70%	22.8735	1.962349
220	50	2.97%	25.415	2.174332
240	56	3.24%	28.4648	2.428468
260	62	3.51%	31.5146	2.681151
280	66	3.78%	33.5478	2.846133
300	69	4.05%	35.0727	2.967145
320	65	4.32%	33.0395	2.787263

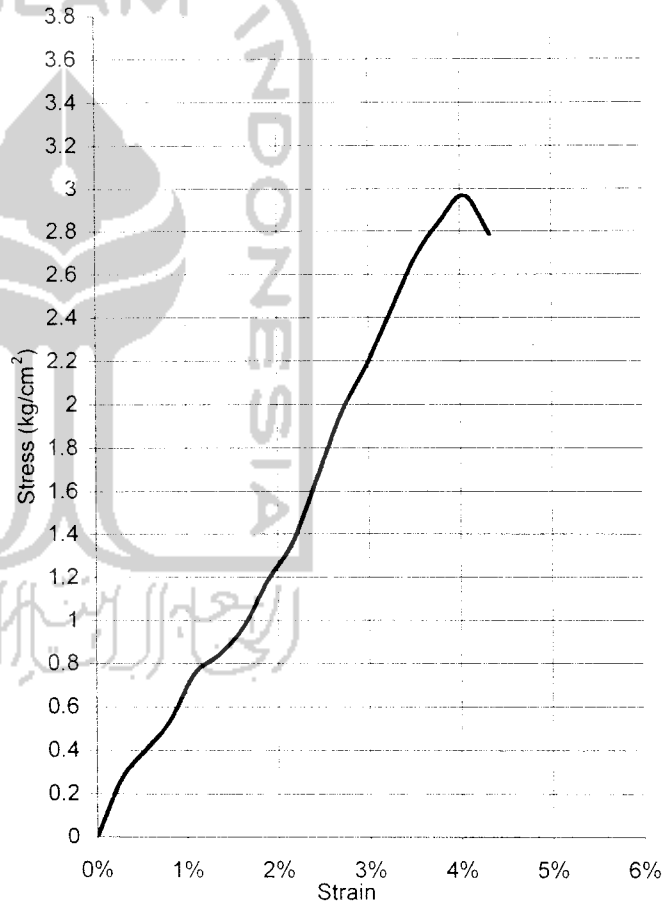

qu =	2.96714 kg/cm ²
α =	61.5 °
Angle Of Internal friction, φ =	33 °
Cohesion =	0.806 kg/cm ²

Diperiksa Oleh :

Dr. Ir. Edy Purwanto, CES, DEA



LABORATORIUM MEKANIKA TANAH
JURUSAN TEKNIK SIPIL-FTSP
UNIVERSITAS ISLAM INDONESIA

UNCONFINED COMPRESSION TEST

Proyek : Tugas Akhir
 Location : Cepagan, Pekalongan, Jawa Tengah
 Depth :- 1,20 meter

Date : September 2006
 Tested by : Purwadi
 Kode : Lempung + karbid 7,5% (2) 7hari

data	
n)	
n ²)	11.3411
m)	
s)	84.4487
wt (gr/cm ³)	1.74

Water Content	
Wt Container (cup), gr	
Wt of Cup + Wet soil, gr	
Wt of Cup + Dry soil, gr	
Water Content %	
Average water content %	27.71

LRC = 0.5083 kg/div

Load dial (unit)	Unit Strain (ΔL/L ₀)	Total load on sample (kg)	Sample stress (kg/cm ²)
0	0.00%	0	0
20	0.27%	2.5415	0.223494
40	0.54%	5.083	0.445785
60	0.81%	8.6411	0.755788
80	1.07%	11.6909	1.01977
100	1.34%	13.2158	1.149655
120	1.61%	15.249	1.322915
140	1.88%	17.7905	1.53919
160	2.15%	20.8403	1.798118
180	2.42%	23.3818	2.011866
200	2.68%	25.9233	2.224411
220	2.95%	28.4648	2.435752
240	3.22%	31.0063	2.64589
260	3.49%	33.0395	2.811571
280	3.76%	34.0561	2.890019
300	4.03%	33.0395	2.795929
320	4.30%	30.498	2.573638

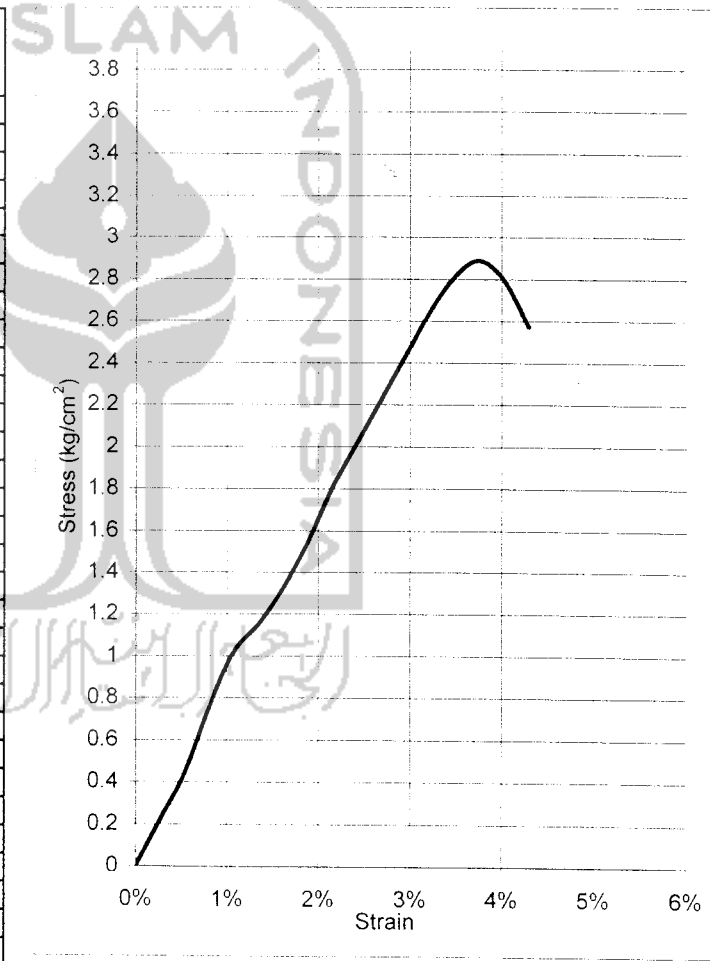

qu =	2.89002 kg/cm ²
α =	62 °
Angle Of Internal friction, φ =	34 °
Cohesion =	0.768 kg/cm ²

Diperiksa Oleh :

Dr. Ir. Edy Purwanto, CES, DEA

UNCONFINED COMPRESSION TEST

Proyek : Tugas Akhir
 Location : Cepagan, Pekalongan, Jawa Tengah
 Depth : -1,20 meter

Date : September 2006
 Tested by : Purwadi
 Kode : Lempung + Karbid 7,5% (1) 14 hari

data	
γ	
γ^2	11.3411
η	
ρ	83.882
$\rho_{wt} (gr/cm^3)$	1.67

Water Content		
Wt Container (cup), gr		
Wt of Cup + Wet soil, gr		
Wt of Cup + Dry soil, gr		
Water Content %		
Average water content %		27.71

LRC = 0.5083 kg/div

Load dial (unit)	Unit Strain (ΔL/L ₀)	Total load on sample (kg)	Sample stress (kg/cm ²)
0	0.00%	0	0
20	0.27%	4.0664	0.357584
40	0.54%	6.0996	0.534922
60	0.81%	7.6245	0.666835
80	1.08%	9.6577	0.842357
100	1.35%	10.6743	0.928482
120	1.62%	12.7075	1.102307
140	1.89%	13.7241	1.187221
160	2.16%	16.2656	1.403201
180	2.43%	18.8071	1.617969
200	2.70%	15.7573	1.351841

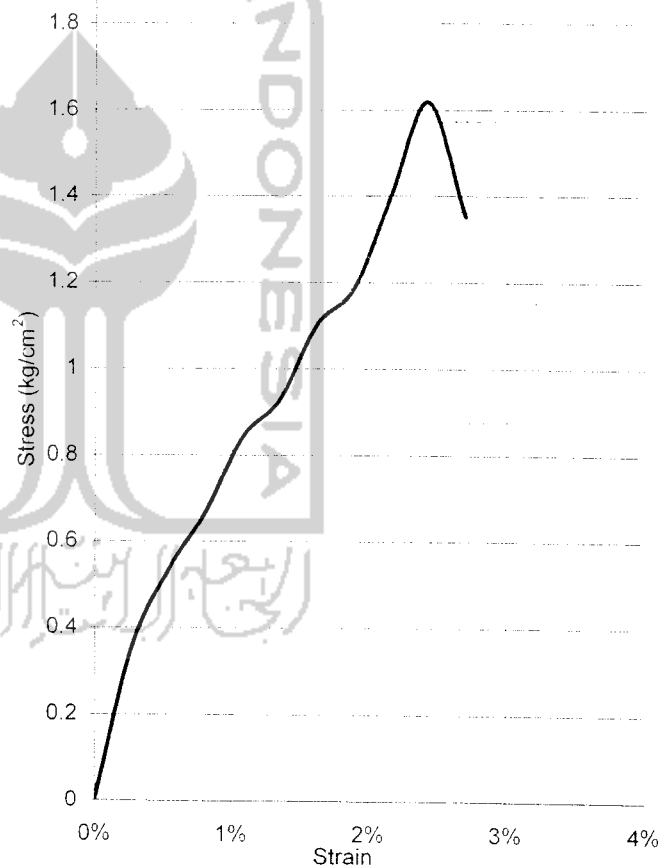

q_u	=	1.61797 kg/cm ²
α	=	63 °
Angle Of Internal friction, ϕ	=	36 °
Cohesion	=	0.412 kg/cm ²

Diperiksa Oleh :

Purwadi

Dr. Ir. Edy Purwanto, CES, DEA



LABORATORIUM MEKANIKA TANAH
JURUSAN TEKNIK SIPIL-FTSP
UNIVERSITAS ISLAM INDONESIA

UNCONFINED COMPRESSION TEST

Proyek : Tugas Akhir
 Location : Cepagan, Pekalongan, Jawa Tengah
 Depth : - 1,20 meter

Date : September 2006
 Tested by : Purwadi
 Kode : Lempung + karbid 7,5% (2) 14hari

data	
m)	
m ²)	11.3411
cm)	
m ³)	84.4487
unit wt (gr/cm ³)	1.73

Water Content	
Wt Container (cup), gr	
Wt of Cup + Wet soil, gr	
Wt of Cup + Dry soil, gr	
Water Content %	
Average water content %	27.71

LRC = 0.5083 kg/div

Load dial (unit)	Unit Strain (ΔL/L ₀)	Total load on sample (kg)	Sample stress (kg/cm ²)
0	0.00%	0	0
20	0.27%	2.5415	0.223494
40	0.54%	5.083	0.445785
60	0.81%	7.1162	0.622414
80	1.07%	9.6577	0.842418
100	1.34%	12.7075	1.105437
120	1.61%	14.7407	1.278818
140	1.88%	16.7739	1.451236
160	2.15%	19.3154	1.666548
180	2.42%	19.8237	1.705712
200	2.68%	19.8237	1.70102
220	2.95%	17.7905	1.522345

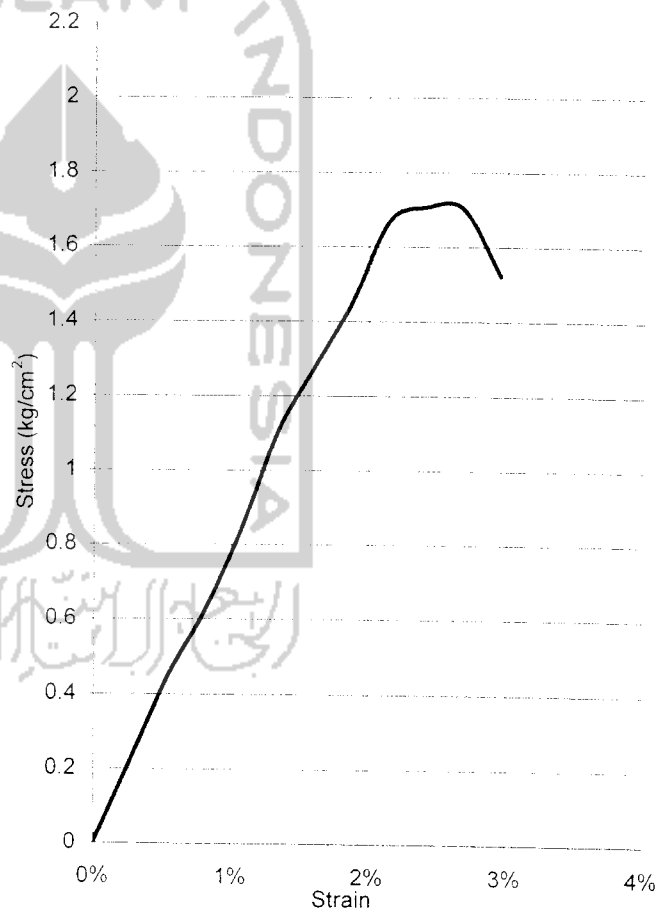

qu = 1.70571 kg/cm²
 α = 63.5 °
 Angle Of Internal friction, φ = 37 °
 Cohesion = 0.425 kg/cm²

Diperiksa Oleh :

Dr. Ir. Edy Purwanto, CES, DEA



LAMPIRAN 13

Pengujian Tekan Bebas Tanah + Karbid 10%



LABORATORIUM MEKANIKA TANAH
JURUSAN TEKNIK SIPIL-FTSP
UNIVERSITAS ISLAM INDONESIA

UNCONFINED COMPRESSION TEST

Proyek : Tugas Akhir
 Location : Cepagan, Pekalongan, Jawa Tengah
 Depth : - 1,20 meter

Date : September 2006
 Tested by : Purwadi
 Kode : Lempung + Karbid 10% (1) 3hari

Height (cm)	
Area (cm ²)	11.3411
Volume (cm ³)	83.882
Unit wt (gr/cm ³)	1.69

Water Content	
Wt Container (cup), gr	
Wt of Cup + Wet soil, gr	
Wt of Cup + Dry soil, gr	
Water Content %	
Average water content %	27.71

LRC = 0.5083 kg/div

Load (kg)	Load dial (unit)	Unit Strain (ΔL/Lo)	Total load on sample (kg)	Sample stress (kg/cm ²)
0	0	0.00%	0	0
20	4	0.27%	2.0332	0.178792
40	8	0.54%	4.0664	0.356615
60	11	0.81%	5.5913	0.489013
80	15	1.08%	7.6245	0.665018
100	19	1.35%	9.6577	0.840055
120	23	1.62%	11.6909	1.014123
140	25	1.89%	12.7075	1.099279
160	28	2.16%	14.2324	1.227801
180	35	2.43%	17.7905	1.530511
200	38	2.70%	19.3154	1.657095
220	35	2.97%	17.7905	1.522032

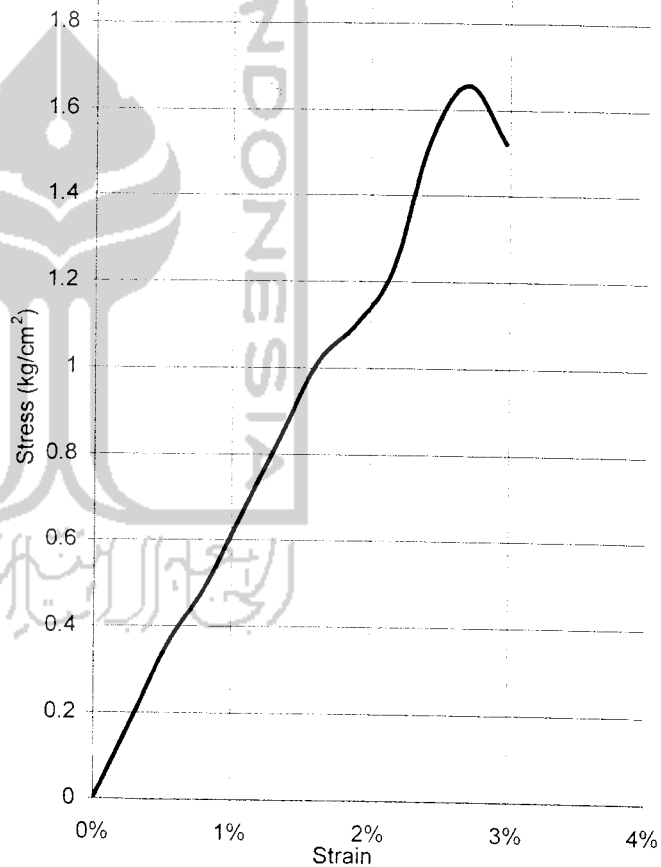

qu = 1.65710 kg/cm²
 α = 60 °
 Angle Of Internal friction, φ = 30 °
 Cohesion = 0.478 kg/cm²

Diperiksa Oleh

Dr. Ir. Edy Purwanto, CES, DEA



LABORATORIUM MEKANIKA TANAH

JURUSAN TEKNIK SIPIL-FTSP

UNIVERSITAS ISLAM INDONESIA

UNCONFINED COMPRESSION TEST

Proyek : Tugas Akhir
Location : Cepagan, Pekalongan, Jawa Tengah
Depth : - 1,20 meter

Date : September 2006
Tested by : Purwadi
Kode : Lempung + karbid 10% (2) 3hari

data	
m)	
m ²)	10.7521
m)	
m)	80.0625
it wt (gr/cm ³)	1.76

Water Content	
Wt Container (cup), gr	
Wt of Cup + Wet soil, gr	
Wt of Cup + Dry soil, gr	
Water Content %	
Average water content %	27.71

LRC = 0.5083 kg/div

ation ding (kg/cm ²)	Load dial (unit)	Unit Strain ($\Delta L/L_0$)	Total load on sample (kg)	Sample stress (kg/cm ²)
0	0	0.00%	0	0
20	3	0.27%	1.5249	0.141443
40	5	0.54%	2.5415	0.235103
60	8	0.81%	4.0664	0.37515
80	10	1.07%	5.083	0.467668
100	14	1.34%	7.1162	0.652959
120	16	1.61%	8.1328	0.744208
140	18	1.88%	9.1494	0.83495
160	24	2.15%	12.1992	1.110221
180	29	2.42%	14.7407	1.337836
200	31	2.68%	15.7573	1.426166
220	35	2.95%	17.7905	1.605746
240	38	3.22%	19.3154	1.738559
260	42	3.49%	21.3486	1.916235
280	48	3.76%	24.3984	2.183891
300	53	4.03%	26.9399	2.404653
320	55	4.30%	27.9565	2.488415
340	51	4.56%	25.9233	2.300966

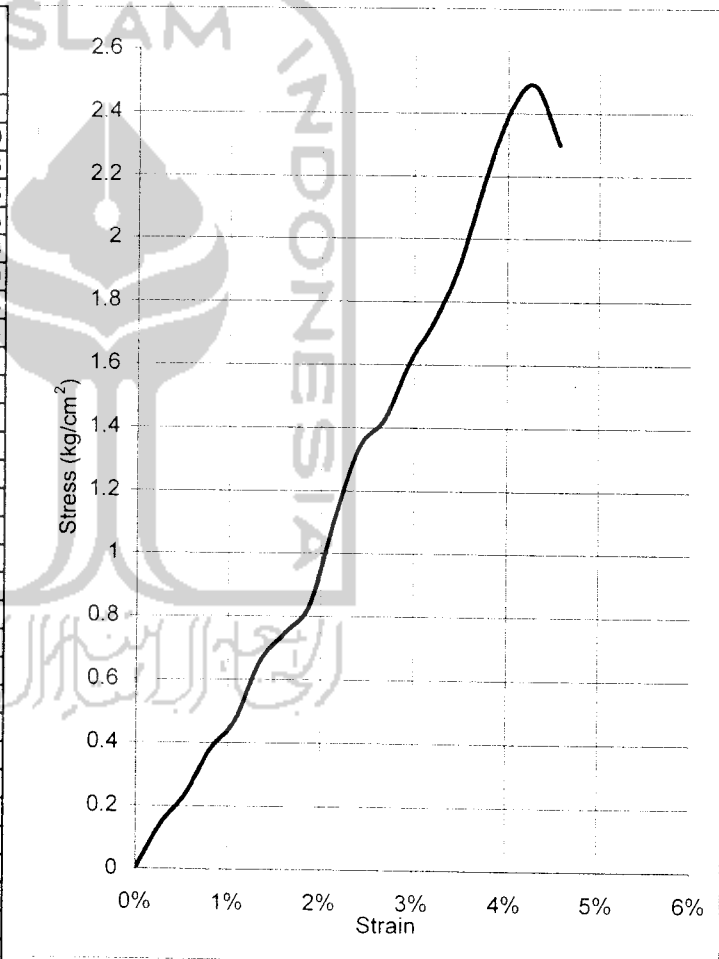

qu	=	2.48841 kg/cm ²
α	=	61°
Angle Of Internal friction, φ	=	32°
Cohesion	=	0.690 kg/cm ²

Diperiksa Oleh :

Dr. Ir. Epy Purwanto, CES, DEA



LABORATORIUM MEKANIKA TANAH
JURUSAN TEKNIK SIPIL-FTSP
UNIVERSITAS ISLAM INDONESIA

UNCONFINED COMPRESSION TEST

Proyek : Tugas Akhir
 Location : Cepagan, Pekalongan, Jawa Tengah
 Depth : - 1,20 meter

Date : September 2006
 Tested by : Purwadi
 Kode : Lempung + Karbid 10% (1) 3hari

data	
n)	
n ²)	11.3411
m)	
s)	83.882
wt (gr/cm ³)	1.74

Water Content	
Wt Container (cup), gr	
Wt of Cup + Wet soil, gr	
Wt of Cup + Dry soil, gr	
Water Content %	
Average water content %	27.71

LRC = 0.5083 kg/div

ation ding (⁻²)	Load dial (unit)	Unit Strain (ΔL/Lo)	Total load on sample (kg)	Sample stress (kg/cm ²)
0	0	0.00%	0	0
20	8	0.27%	4.0664	0.357584
40	11	0.54%	5.5913	0.490345
60	17	0.81%	8.6411	0.755747
80	23	1.08%	11.6909	1.019695
100	29	1.35%	14.7407	1.282189
120	35	1.62%	17.7905	1.54323
140	38	1.89%	19.3154	1.670904
160	35	2.16%	17.7905	1.534751
180	25	2.43%	12.7075	1.093222

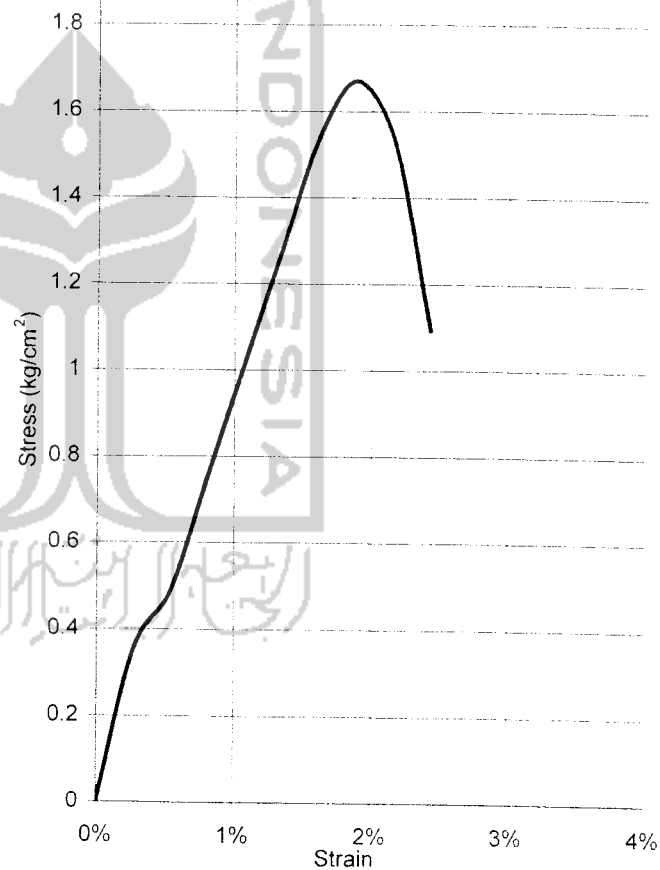

qu =	1.67090 kg/cm ²
α =	61 °
Angle Of Internal friction, φ =	32 °
Cohesion =	0.463 kg/cm ²

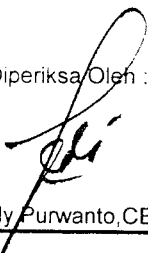
Diperiksa Oleh :

Dr. Ir. Edy Purwanto, CES, DEA



LABORATORIUM MEKANIKA TANAH
JURUSAN TEKNIK SIPIL-FTSP
UNIVERSITAS ISLAM INDONESIA

UNCONFINED COMPRESSION TEST

Proyek : Tugas Akhir
 Location : Cepagan, Pekalongan, Jawa Tengah
 Depth :- 1,20 meter

Date : September 2006
 Tested by : Purwadi
 Kode : Lempung + karbid 10% (2)
 7hari

Data	
γ)	
γ _s)	11.3411
n)	
γ _w)	84.4487
wt (gr/cm ³)	1.72

Water Content	
Wt Container (cup), gr	
Wt of Cup + Wet soil, gr	
Wt of Cup + Dry soil, gr	
Water Content %	
Average water content %	27.71

LRC = 0.5083 kg/div

Time (min)	Load dial (unit)	Unit Strain (ΔL/L ₀)	Total load on sample (kg)	Sample stress (kg/cm ²)
0	0	0.00%	0	0
20	7	0.27%	3.5581	0.312891
40	10	0.54%	5.083	0.445785
60	16	0.81%	8.1328	0.71133
80	21	1.07%	10.6743	0.931094
100	26	1.34%	13.2158	1.149655
120	35	1.61%	17.7905	1.543401
140	41	1.88%	20.8403	1.803051
160	48	2.15%	24.3984	2.105114
180	55	2.42%	27.9565	2.405492
200	51	2.68%	25.9233	2.224411

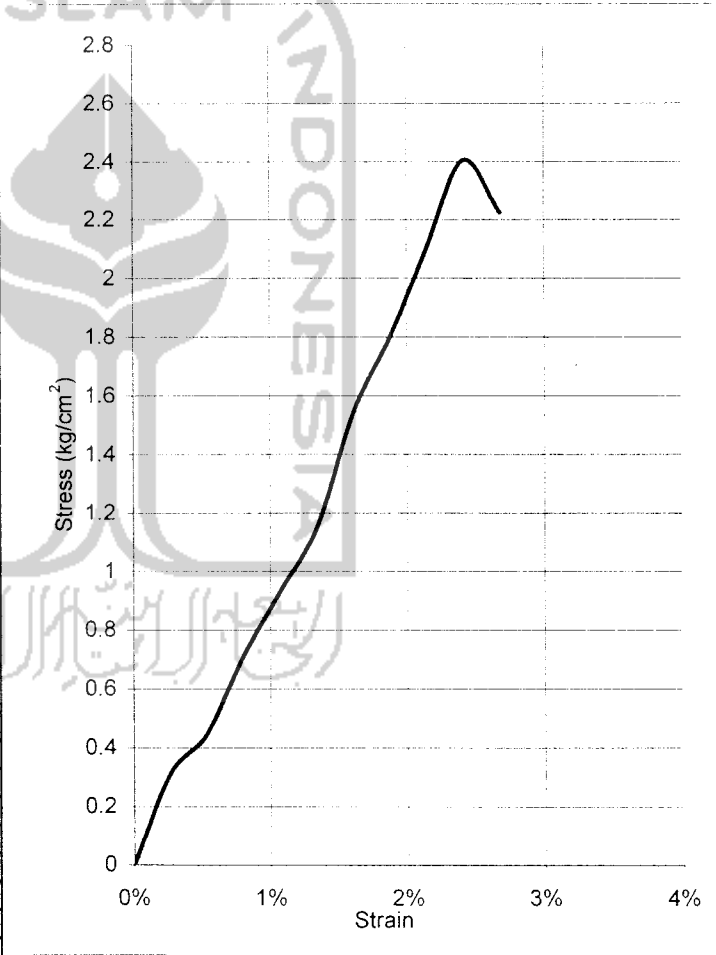

Diperiksa Oleh :

q _u =	2.40549 kg/cm ²
α =	61.5 °
Angle Of Internal friction, φ =	33 °
Cohesion =	0.653 kg/cm ²



LABORATORIUM MEKANIKA TANAH
JURUSAN TEKNIK SIPIL-FTSP
UNIVERSITAS ISLAM INDONESIA

UNCONFINED COMPRESSION TEST

Proyek : Tugas Akhir
 Location : Cepagan, Pekalongan, Jawa Tengah
 Depth : - 1,20 meter

Date : September 2006
 Tested by : Purwadi
 Kode : Lempung + Karbid 10% (1) 14hari

data	
n)	
n ²)	11.3411
m)	
)	83.882
wt (gr/cm ³)	1.68

Water Content	
Wt Container (cup), gr	
Wt of Cup + Wet soil, gr	
Wt of Cup + Dry soil, gr	
Water Content %	
Average water content %	27.71

LRC = 0.5083 kg/div

Load dial (unit)	Unit Strain ($\Delta L/L_0$)	Total load on sample (kg)	Sample stress (kg/cm ²)
0	0.00%	0	0
20	0.27%	5.083	0.44698
40	0.54%	8.1328	0.713229
60	0.81%	10.6743	0.93357
80	1.08%	12.1992	1.064029
100	1.35%	14.2324	1.237976
120	1.62%	15.7573	1.366861
140	1.89%	17.2822	1.495019
160	2.16%	19.56955	1.688226
180	2.43%	20.8403	1.792885
200	2.70%	19.3154	1.657095

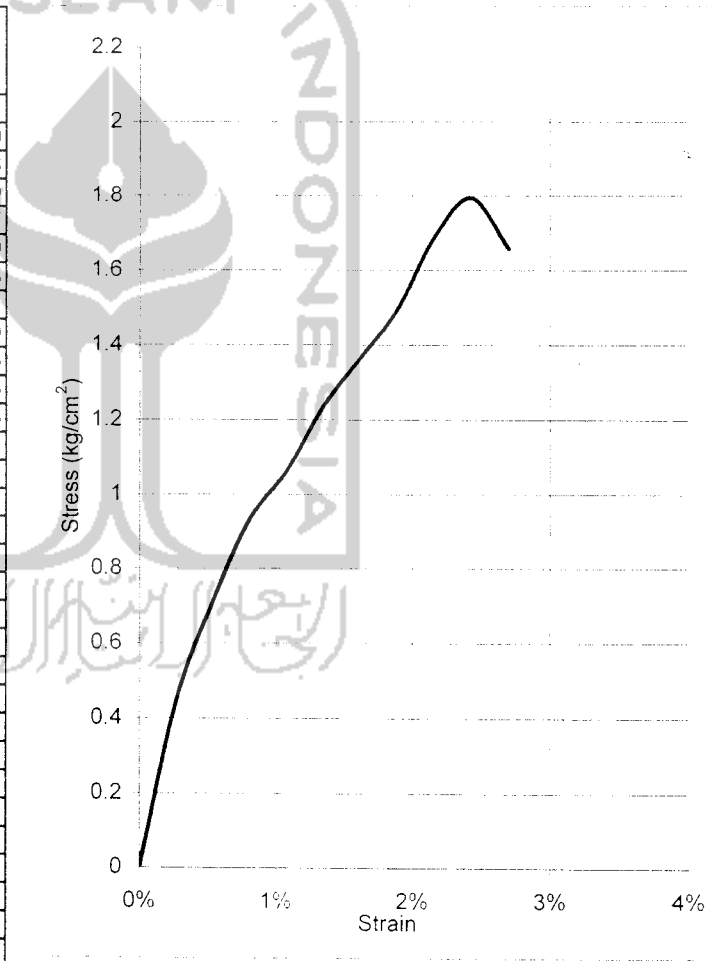

qu = 1.79288 kg/cm²
 α = 62.5°
 Angle Of Internal friction, ϕ = 35°
 Cohesion = 0.467 kg/cm²

Diperiksa Oleh :

Dr. Ir. Edy Purwanto, CES, DEA



LABORATORIUM MEKANIKA TANAH
JURUSAN TEKNIK SIPIL-FTSP
UNIVERSITAS ISLAM INDONESIA

UNCONFINED COMPRESSION TEST

Proyek : Tugas Akhir
 Location : Cepagan, Pekalongan, Jawa Tengah
 Depth : - 1,20 meter

Date : September 2006
 Tested by : Purwadi
 Kode : Lempung + karbid 10% (2) 14hari

Data	
γ	
γ_r	11.3411
γ_d	
w	84.4487
ρ_w (gr/cm ³)	1.70

Water Content	
Wt Container (cup), gr	
Wt of Cup + Wet soil, gr	
Wt of Cup + Dry soil, gr	
Water Content %	
Average water content %	27.71

LRC = 0.5083 kg/div

Load Increment (kg)	Load Applied (unit)	Unit Strain ($\Delta L/L_0$)	Total load on sample (kg)	Sample stress (kg/cm ²)
0	0	0.00%	0	0
20	5	0.27%	2.5415	0.223494
40	9	0.54%	4.5747	0.401206
60	12	0.81%	6.0996	0.533498
80	18	1.07%	9.1494	0.798081
100	23	1.34%	11.6909	1.017002
120	29	1.61%	14.7407	1.278818
140	37	1.88%	18.8071	1.627144
160	39	2.15%	19.8237	1.710405
180	40	2.42%	20.332	1.749449
200	39	2.68%	19.8237	1.70102
220	35	2.95%	17.7905	1.522345

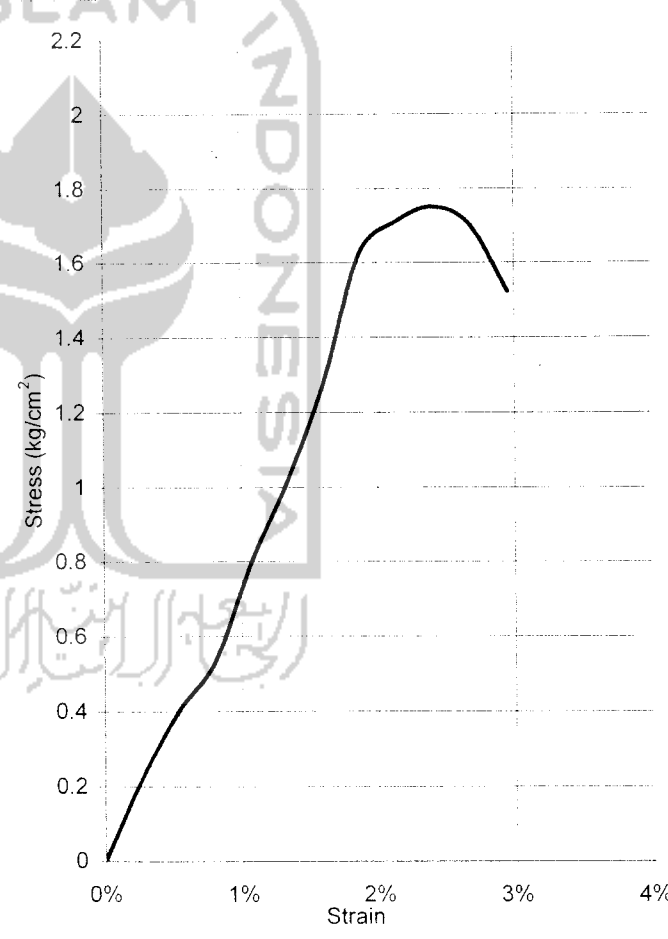

q_u	=	1.74945 kg/cm ²
α	=	63.5 °
Angle Of Internal friction, ϕ	=	37 °
Cohesion	=	0.436 kg/cm ²

Diperiksa Oleh :

Dr. Ir. Edy Purwanto, CES, DEA



LAMPIRAN 14

Pengujian Triaxial Tanah Undisturb



LABORATORIUM MEKANIKA TANAH
FAKULTAS TEKNIK SIPIL DAN PERENCANAAN
UNIVERSITAS ISLAM INDONESIA

Jl. Kaliurang KM 14,5 Telp. (0274) 895042, 895707, fax 895330 Yogyakarta 55584

TRIAXIAL TEST

Project : Tugas Akhir
 Location : Cepagan, Pekalongan, Jawa Tengah
 Description of soil : Undisturbed Silty Clay

Depth : 1,20 meter
 Date : September 1, 2006
 Tested by : Purwadi

Diameter benda uji	3.98 cm
Tinggi benda uji	7.60 cm
Luas mula-mula	12.44 cm ²
Volume benda uji	94.55 cm ³
Berat benda uji	gram
Berat volume tanah	1.711 gr/cm ³
Kalibrasi	0.165

Kadar air : 56.26

Pembacaan beban

Reaganan		Luas benda uji			Tekanan sel = 0.25 kg/cm ²			Tekanan sel = 0.5 kg/cm ²			Tekanan sel = 1.00 kg/cm ²		
Pemb. dial	L = a/10 ³	LL	koreksi	A=luas	Pemb. dial	Beban P	= P/A	Pemb. dial	Beban P	= P/A	Pemb. dial	Beban P	= P/A
(a)	(cm)	(%)	1-e	[A ₀ (1+e)]		(kg)	(kg/cm ²)		(kg)	(kg/cm ²)		(kg)	(kg/cm ²)
1	2	3	4	5	6	7	8	9	10	11	12	13	14
0	0	0.00	1.000	12.44	0	0.000	0.000	0	0.000	0.000	0	0.000	0.000
40	0.04	0.32	0.997	12.40	13.5	2.228	0.180	21	3.465	0.279	28	4.620	0.373
80	0.08	0.64	0.994	12.36	15	2.475	0.200	23	3.795	0.307	29	4.785	0.387
120	0.12	0.96	0.990	12.32	19	3.135	0.254	24	3.960	0.321	31	5.115	0.415
160	0.16	1.29	0.987	12.28	20.5	3.383	0.275	31	5.115	0.416	33	5.445	0.443
200	0.20	1.61	0.984	12.24	22.5	3.713	0.303	33.5	5.528	0.452	36	5.940	0.485
240	0.24	1.93	0.981	12.20	23.5	3.878	0.318	35.5	5.858	0.480	39.5	6.518	0.534
280	0.28	2.25	0.977	12.16	23.5	3.878	0.319	37	6.105	0.502	45	7.425	0.611
320	0.32	2.57	0.974	12.12	26	4.290	0.354	38	6.270	0.517	50	8.250	0.681
360	0.36	2.89	0.971	12.08	27.5	4.538	0.376	38.5	6.353	0.526	52.5	8.663	0.717
400	0.40	3.22	0.968	12.04	27.5	4.538	0.377	39.5	6.518	0.541	53.5	8.828	0.733
440	0.44	3.54	0.965	12.00	28.5	4.703	0.392	40.5	6.683	0.557	54.5	8.993	0.749
480	0.48	3.86	0.961	11.96	28.5	4.703	0.393	41.5	6.848	0.572	55	9.075	0.759
520	0.52	4.18	0.958	11.92	29	4.785	0.401	42.5	7.013	0.588	56	9.240	0.775
560	0.56	4.50	0.955	11.88	29.5	4.868	0.410	42.5	7.013	0.590	56.5	9.323	0.785
600	0.60	4.82	0.952	11.84	29.5	4.868	0.411	42	6.930	0.585	56.5	9.323	0.787
640	0.64	5.14	0.949	11.80	30	4.950	0.419	43.5	7.178	0.608	57	9.405	0.797
680	0.68	5.47	0.945	11.76	31	5.115	0.435	43.5	7.178	0.610	57.5	9.488	0.807
720	0.72	5.79	0.942	11.72	32	5.280	0.450	44	7.260	0.619	57.5	9.488	0.809
760	0.76	6.11	0.939	11.68	33	5.445	0.466	44.5	7.343	0.629	58	9.570	0.819
800	0.80	6.43	0.936	11.64	33.5	5.528	0.475	45	7.425	0.638	59	9.735	0.836
840	0.84	6.75	0.932	11.60	34	5.610	0.484	44	7.260	0.626	60	9.900	0.853
880	0.88	7.07	0.929	11.56	35	5.775	0.500	40	6.600	0.571	62.5	10.313	0.892
900	0.90	7.23	0.928	11.54	36	5.940	0.513				59	9.735	0.844
940	0.94	7.56	0.924	11.50	35	5.775	0.502						
980	0.98	7.88	0.921	11.46	34	5.610	0.489						
1020	1.02	8.20	0.918	11.42	32	5.280	0.462						
1080	1.08	8.68	0.913	11.36	31	5.115	0.450						



LABORATORIUM MEKANIKA TANAH
FAKULTAS TEKNIK SIPIL DAN PERENCANAAN
UNIVERSITAS ISLAM INDONESIA

Jl. Kaliurang KM 14,5 Telp. (0274) 895042, 895707, fax 895330 Yogyakarta 55584

TRIAXIAL TEST

Project : Final Assignment
 Location : Cepagan, Pekalongan, Jawa Tengah
 Description of soil : Undisturbed Silty Clay (1)

Depth : 1,20 meter
 Date : September 1, 2006
 Tested by : Purwadi

Kadar air

No. Pengujian	1	2
Berat container, gr	0	0
Berat cont. + tanah basah, gr	0	0
Berat cont. + tanah kering, gr	0	0
Kadar air	0.00	0.00
Kadar air rata-rata	56.26	

No Pengujian	1	2	3
Diameter benda uji, cm	3.98	3.83	3.79
Tinggi benda uji, cm	7.60	7.70	7.64
Luas mula-mula, cm ²	12.44	11.52	11.28
Volume benda uji, cm ³	94.55	88.71	86.19
Berat benda uji, gr	152.43	157.96	161.74
Berat vol tanah, gr/cm ³	1.612	1.781	1.877
Kalibrasi	0.165		

Brt vol. basah, gr/cm ³	1.612	1.781	1.877
Brt vol. kering, gr/cm ³	1.032	1.140	1.201

σ_3	0.25	0.5	1.0
$\sigma_1 = P/A$	0.515	0.638	0.892
$\sigma_1 = \Delta\sigma + \sigma_3$	0.765	1.138	1.892
$(\sigma_1 + \sigma_3)/2$	0.507	0.819	1.446
$(\sigma_1 - \sigma_3)/2$	0.257	0.319	0.446

Sudut gesek dalam ($^\circ$)	12.68
Nilai kohesi (kg/cm ²)	0.13

Grafik Tegangan-Regangan

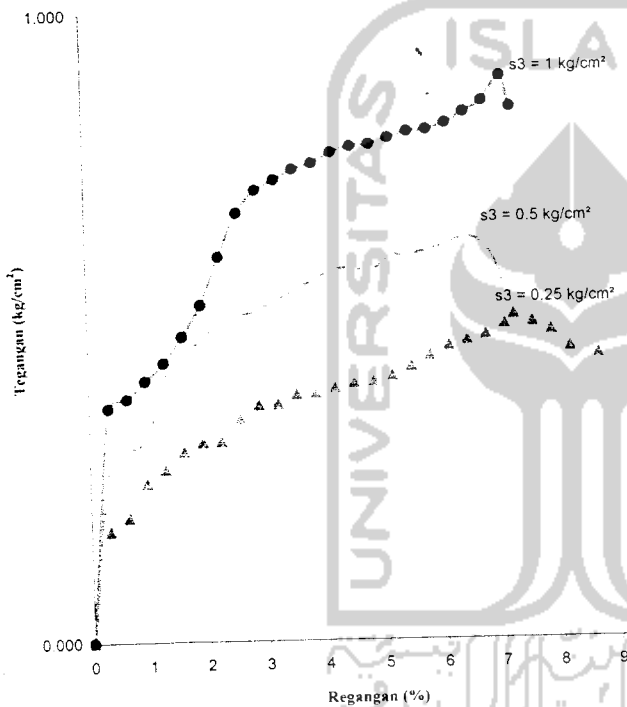
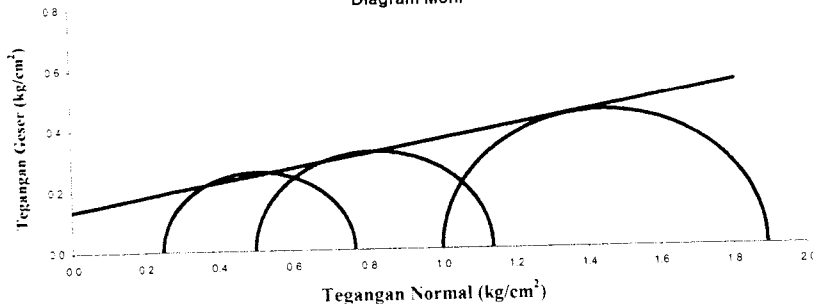

Diagram Mohr



Diperiksa Oleh :

Dr. Ir. Edy Purwanto, CES, DEA



LABORATORIUM MEKANIKA TANAH
FAKULTAS TEKNIK SIPIL DAN PERENCANAAN
UNIVERSITAS ISLAM INDONESIA

Jl. Kaliurang KM 14,5 Telp. (0274) 895042, 895707, fax 895330 Yogyakarta 55584

TRIAxIAL TEST

Project : Tugas Akhir
 Location : Cepagan, Pekalongan, Jawa Tengah
 Description of soil : Undisturbed Silty Clay(2)

Depth : 1,20 meter
 Date : September 1, 2006
 Tested by : Purwadi

Diameter benda uji	3.98 cm
Tinggi benda uji	7.60 cm
Luas mula-mula	12.44 cm ²
Volume benda uji	94.55 cm ³
Berat benda uji	gram
Berat volume tanah	1.681 gr/cm ³
Kalibrasi	0.165

Kadar air	56.28
-----------	-------

Pembacaan beban

Regangan		Luas benda uji			Tekanan sel = 0.25 kg/cm ²			Tekanan sel = 0.5 kg/cm ²			Tekanan sel = 1.00 kg/cm ²		
Pemb. dial	L = a 10 ⁻³	LL	koreksi luas	A=luas terkoreksi	Pemb dial	Beban P (kg)	= P/A (kg/cm ²)	Pemb dial	Beban P (kg)	= P/A (kg/cm ²)	Pemb dial	Beban P (kg)	= P/A (kg/cm ²)
(a)	(cm)	(%)	1-e	1/Ao(4)	6	7	8	9	10	11	12	13	14
0	0	0.00	1.000	12.44	0	0.000	0.000	0	0.000	0.000	0	0.000	0.000
40	0.04	0.32	0.997	12.40	12	1.980	0.160	20	3.300	0.266	28	4.620	0.373
80	0.08	0.64	0.994	12.36	16	2.640	0.214	24	3.960	0.320	29	4.785	0.387
120	0.12	0.96	0.990	12.32	18	2.970	0.241	26	4.290	0.348	31	5.115	0.415
160	0.16	1.29	0.987	12.28	20	3.465	0.282	27.5	4.538	0.369	33	5.445	0.443
200	0.20	1.61	0.984	12.24	22.5	3.548	0.290	28.5	4.705	0.384	36	5.940	0.485
240	0.24	1.93	0.981	12.20	25	3.715	0.304	30	4.950	0.406	39.5	6.318	0.514
280	0.28	2.25	0.977	12.16	28	3.960	0.326	32	5.280	0.434	45	7.425	0.611
320	0.32	2.57	0.974	12.12	26	4.290	0.354	33	5.445	0.449	50	8.250	0.681
360	0.36	2.89	0.971	12.08	27	4.455	0.369	34	5.610	0.464	52.5	8.665	0.717
400	0.40	3.22	0.968	12.04	27.5	4.538	0.377	34.5	5.698	0.473	53.5	8.828	0.713
440	0.44	3.54	0.965	12.00	28	4.620	0.385	35	5.775	0.481	54.5	8.993	0.740
480	0.48	3.86	0.961	11.96	28.5	4.705	0.393	37.5	6.188	0.517	55	9.075	0.759
520	0.52	4.18	0.958	11.92	29	4.785	0.401	38	6.270	0.526	56	9.240	0.775
560	0.56	4.50	0.955	11.88	30	4.950	0.417	38.5	6.355	0.535	56.5	9.323	0.785
600	0.60	4.82	0.952	11.84	30.5	5.035	0.425	39	6.435	0.543	56.5	9.323	0.787
640	0.64	5.14	0.949	11.80	31.5	5.198	0.440	39.5	6.518	0.552	57	9.405	0.797
680	0.68	5.47	0.945	11.76	32	5.280	0.449	39.5	6.518	0.554	57.5	9.488	0.807
720	0.72	5.79	0.942	11.72	32	5.610	0.479	40	6.600	0.563	57.5	9.488	0.809
760	0.76	6.11	0.939	11.68	33	5.775	0.494	40.5	6.685	0.572	58	9.570	0.819
800	0.80	6.43	0.936	11.64	29	4.785	0.411	41	6.765	0.581	59.5	9.818	0.843
840	0.84	6.75	0.932	11.60	28	4.620	0.398	42	6.930	0.597	58	9.570	0.825
880	0.88	7.07	0.929	11.56				41	6.765	0.585	57	9.405	0.814
900	0.90	7.23	0.928	11.54				40	6.600	0.572	52	8.580	0.743
920	0.92	7.39	0.926	11.52				38	6.270	0.544			



LABORATORIUM MEKANIKA TANAH

FAKULTAS TEKNIK SIPIL DAN PERENCANAAN

UNIVERSITAS ISLAM INDONESIA

Jl. Kaliurang KM 14,5 Telp. (0274) 895042, 895707, fax 895330 Yogyakarta 55584

TRIAXIAL TEST

Project : Final Assignment
 Location : Cepagan, Pekalongan, Jawa Tengah
 Description of soil : Undisturbed Silty Clay(2)

Depth : 1,20 meter
 Date : September 1, 2006
 Tested by : Purwadi

Kadar air

No. Pengujian	1	2
Berat container, gr	0	0
Berat cont. + tanah basah, gr	0	0
Berat cont. + tanah kering, gr	0	0
Kadar air	0.00	0.00
Kadar air rata-rata	56.28	

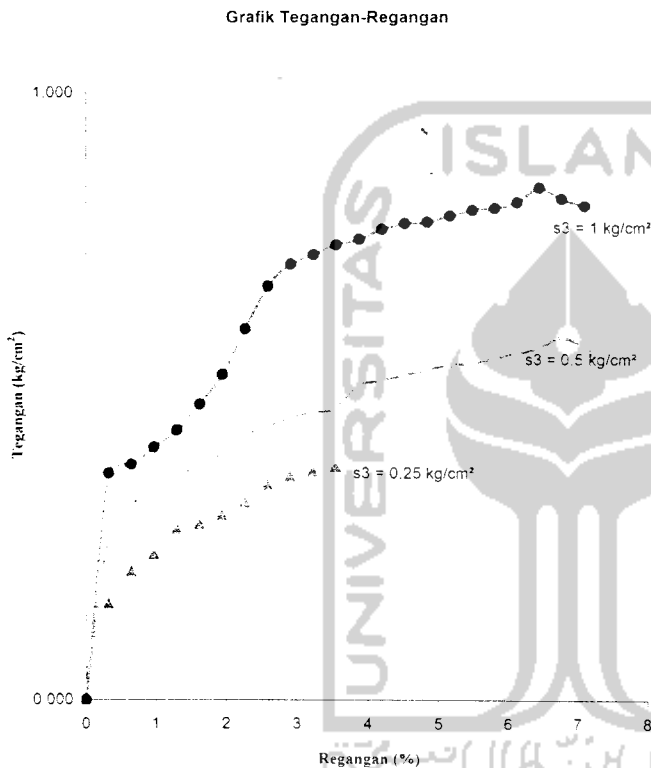

No. Pengujian	1	2	3
Diameter benda uji, cm	3.98	3.83	3.79
Tinggi benda uji, cm	7.60	7.70	7.64
Luas mula-mula, cm ²	12.44	11.52	11.28
Volume benda uji, cm ³	94.55	88.71	86.19
Berat benda uji, gr	152.25	153.96	155.61
Berat vol tanah, gr/cm ³	1.610	1.736	1.805
Kalibrasi	0.165		

Brt vol. basah, gr/cm ³	1.610	1.736	1.805
Brt vol. kering, gr/cm ³	1.030	1.111	1.155

σ_3	0.25	0.5	1.0
$\sigma_1 = P/A$	0.494	0.597	0.843
$\sigma_1 = \sigma_3 + \sigma_3$	0.744	1.097	1.843
$(\sigma_1 + \sigma_3)/2$	0.497	0.799	1.422
$(\sigma_1 - \sigma_3)/2$	0.247	0.299	0.422

Sudut gesek dalam (°)	11.48
Nilai kohesi (kg/cm ²)	0.13

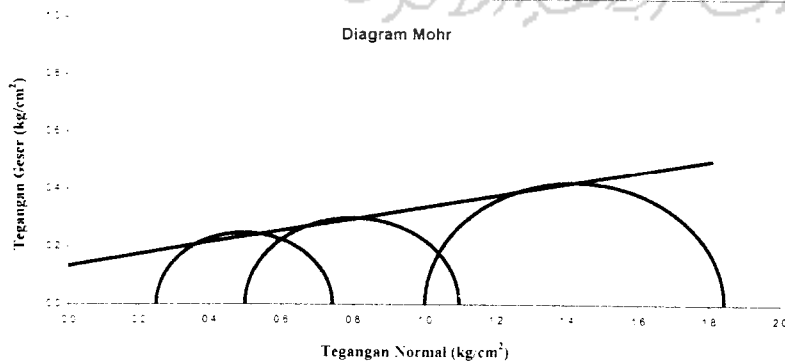

Diperiksa Oleh :

Dr. Ir. Edy Purwanto, CES, DEA



LAMPIRAN 15

Pengujian Triaxial Tanah + Karbid 1.5%



LABORATORIUM MEKANIKA TANAH

FAKULTAS TEKNIK SIPIL DAN PERENCANAAN

UNIVERSITAS ISLAM INDONESIA

Jl. Kaliurang KM 14,5 Telp. (0274) 895042, 895707, fax 895330 Yogyakarta 55584

TRIAXIAL TEST

Project : Final Assignment
 Location : Cepagan, Pekalongan, Jawa Tengah
 Description of soil : Silty Clay 1,5 % Shari(1)

Depth : 1,20 meter
 Date : September 1, 2006
 Tested by : Purwadi

Grafik Tegangan-Regangan

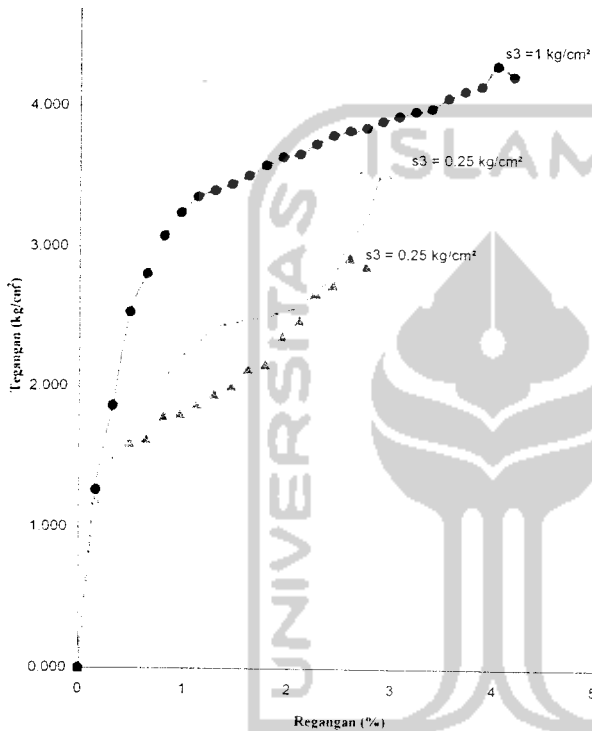

Kadar air

No. Pengujian	1	2
Berat container, gr	0	0
Berat cont. + tanah basah, gr	0	0
Berat cont. + tanah kering, gr	0	0
Kadar air	0.00	0.00
Kadar air rata-rata	27.71	

No. Pengujian	1	2	3
Diameter benda uji, cm	3.98	3.83	3.79
Tinggi benda uji, cm	7.60	7.70	7.64
Luas mula-mula, cm ²	12.44	11.52	11.28
Volume benda uji, cm ³	94.55	88.71	86.19
Berat benda uji, gr	145.49	145.65	148.26
Berat vol.tanah, gr/cm ³	1.539	1.642	1.720
Kalibrasi	0.165		

Brt vol. basah, gr cm ³	1.539	1.642	1.720
Brt vol. kering, gr cm ³	1.205	1.286	1.347

σ_3	0.25	0.5	1.0
$\sigma_1 - P_A$	2.927	3.524	4.284
$\sigma_1 - \sigma_3$	3.177	4.024	5.284
$(\sigma_1 + \sigma_3)/2$	1.713	2.262	3.142
$(\sigma_1 - \sigma_3)/2$	1.463	1.762	2.142

Sudut gesek dalam ($^\circ$)	27.82
Nilai kohesi (kg/cm^2)	0.76

Diagram Mohr

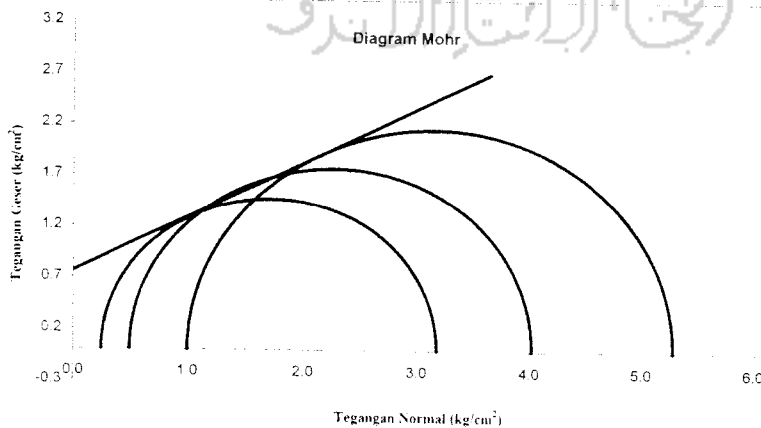

Diperiksa Oleh :

Dr. Ir. Edy Purwanto, CES, DEA



LABORATORIUM MEKANIKA TANAH

FAKULTAS TEKNIK SIPIL DAN PERENCANAAN

UNIVERSITAS ISLAM INDONESIA

Jl. Kaliurang KM 14,5 Telp. (0274) 895042, 895707, fax 895330 Yogyakarta 55584

TRIAXIAL TEST

Project : Final Assignment
 Location : Cepagan, Pekalongan, Jawa Tengah
 Description of soil : Silty Clay 1.5% 3hari (2)

Depth : 1,20 meter
 Date : September 1, 2006
 Tested by : Purwadi

Grafik Tegangan-Regangan

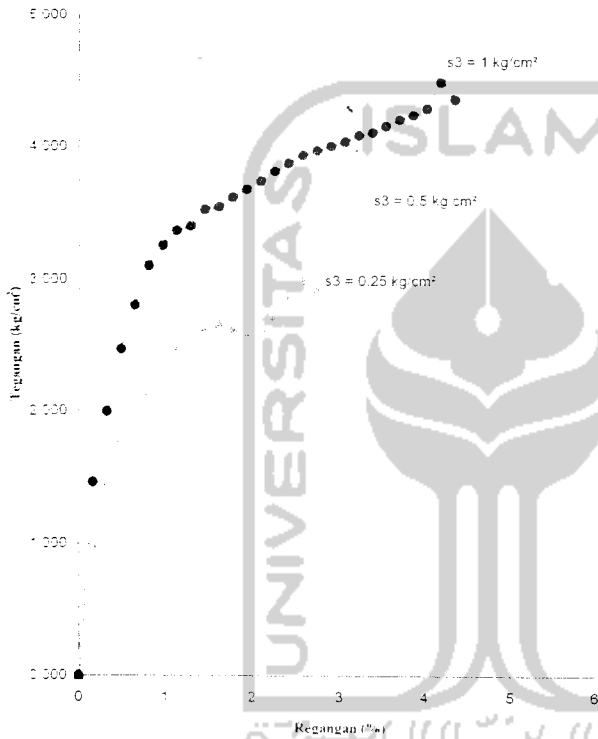

Kadar air

No. Pengujian	1	2
Berat container, gr	0	0
Berat cont. + tanah basah, gr	0	0
Berat cont. + tanah kering, gr	0	0
Kadar air	0.00	0.00
Kadar air rata-rata	27.71	

No. Pengujian	1	2	3
Diameter benda uji, cm	3.98	3.83	3.79
Tinggi benda uji, cm	7.60	7.70	7.64
Luas mula-mula, cm ²	12.44	11.52	11.28
Volume benda uji, cm ³	94.55	88.71	86.19
Berat benda uji, gr	146.12	146.28	146.58
Berat vol tanah, gr/cm ³	1.545	1.649	1.701
Kalibrasi	0.165		

Brt vol. basah, gr/cm ³	1.545	1.649	1.701
Brt vol. kering, gr/cm ³	1.210	1.291	1.332

σ_3	0.25	0.5	1.0
$\sigma_1 = P/A$	2.995	3.522	4.485
$\sigma_1 = \sigma_3 + \sigma_s$	3.245	4.022	5.485
$(\sigma_1 + \sigma_3)/2$	1.747	2.261	3.242
$(\sigma_1 - \sigma_3)/2$	1.497	1.761	2.242

Sudut gesek dalam (°)	28.92
Nilai kohesi (kg/cm ²)	0.73

Diagram Mohr

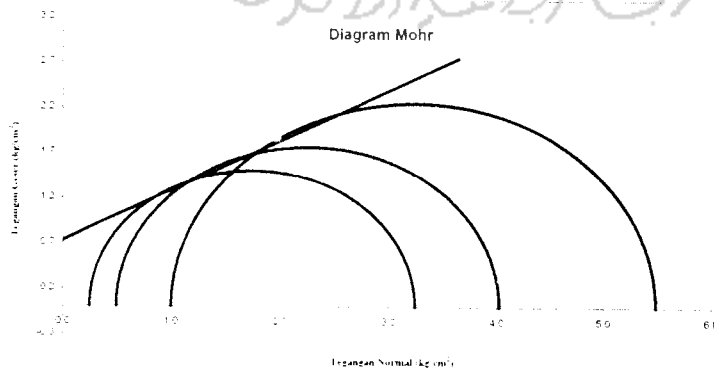

Diperiksa Oleh

Dr. Ir. Epy Purwanto, CES, DEA



LABORATORIUM MEKANIKA TANAH

FAKULTAS TEKNIK SIPIL DAN PERENCANAAN

UNIVERSITAS ISLAM INDONESIA

Jl. Kaliurang KM 14,5 Telp. (0274) 895042, 895707, fax 895330 Yogyakarta 55584

TRIAXIAL TEST

Project : Final Assignment
 Location : Cepagan, Pekalongan, Jawa Tengah
 Description of soil : Silty Clay 1.5% 7hari(1)

Depth : 1,20 meter
 Date : September 1, 2006
 Tested by : Purwadi

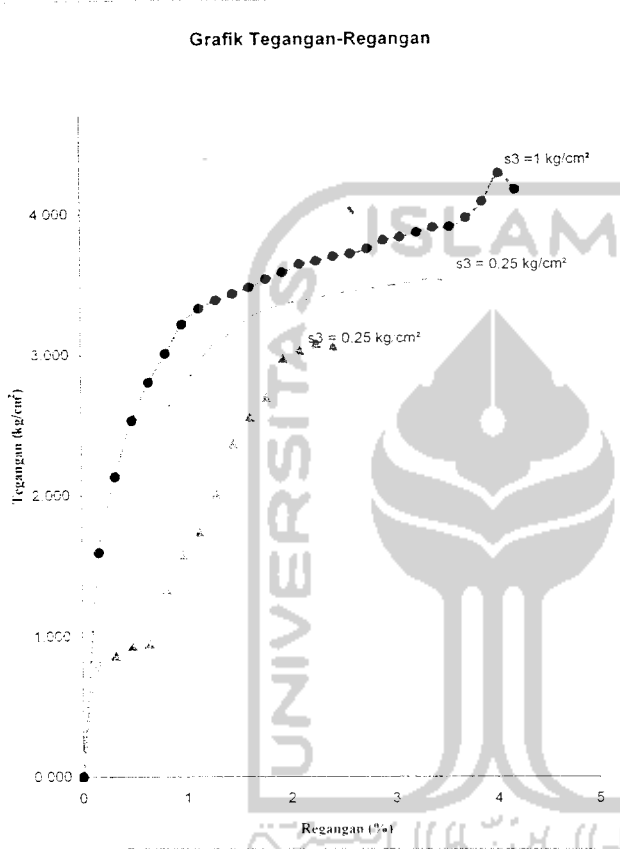

Kadar air

No. Pengujian	1	2
Berat container, gr	0	0
Berat cont. + tanah basah, gr	0	0
Berat cont. + tanah kering, gr	0	0
Kadar air	0.00	0.00
Kadar air rata-rata	27.71	

No. Pengujian	1	2	3
Diameter benda uji, cm	3.98	3.83	3.79
Tinggi benda uji, cm	7.60	7.70	7.64
Luas mula-mula, cm ²	12.44	11.52	11.28
Volume benda uji, cm ³	94.55	88.71	86.19
Berat benda uji, gr	147.95	147.25	149.87
Berat vol.tanah, gr/cm ³	1.565	1.660	1.739
Kalibrasi	0.165		

Brt vol. basah, gr/cm ³	1.565	1.660	1.739
Brt vol. kering, gr/cm ³	1.225	1.300	1.362

σ_3	0.25	0.5	1.0
$\sigma_1 - P/A$	3.080	3.541	4.284
$\sigma_1 - \sigma_3$	3.330	4.041	5.284
$(\sigma_1 + \sigma_3)/2$	1.790	2.271	3.142
$(\sigma_1 - \sigma_3)/2$	1.540	1.771	2.142

Sudut gesek dalam (°)	26.10
Nilai kohesi (kg/cm ²)	0.84

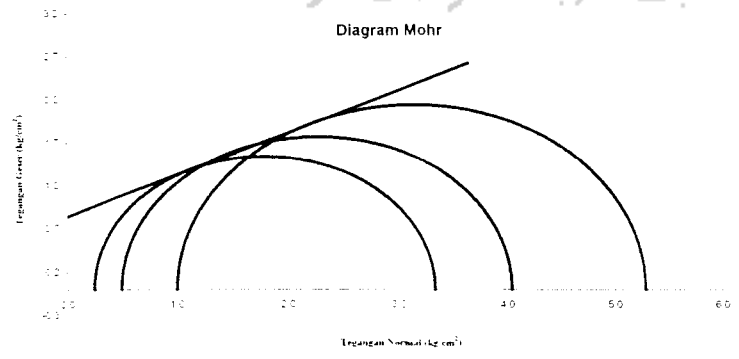

Diperiksa Oleh :

 Dr. Ir. Epy Purwanto, CES, DEA



LABORATORIUM MEKANIKA TANAH
FAKULTAS TEKNIK SIPIL DAN PERENCANAAN
UNIVERSITAS ISLAM INDONESIA

Jl. Kaliurang KM 14,5 Telp. (0274) 895042, 895707, fax 895330 Yogyakarta 55584

TRIAXIAL TEST

Project : Tugas Akhir
Location : Cepagan, Pekalongan, Jawa Tengah
Description of soil : Campuran Kapur Karbid 1,5% (Pemeraman 7 hari)2

Depth : 1,20 meter
Date : September 1, 2006
Tested by : Purwadi

Diameter benda uji	3.98 cm
Tinggi benda uji	7.50 cm
Luas mula-mula	12.44 cm ²
Volume benda uji	93.31 cm ³
Berat benda uji	gram
Berat volume tanah	1.566 gr/cm ³
Kalibrasi	0.165

Kadar air	27.71
-----------	-------

Pembacaan beban

Regangan		Luas benda uji			Tekanan sel = 0,25 kg/cm ²			Tekanan sel = 0,5 kg/cm ²			Tekanan sel = 1,00 kg/cm ²		
Pemb. dial	L ₀ a/10 ⁻³	L L	koreksi luas	A luas koreksi	Pemb. dial	Beban P (kg)	= P/A (kg/cm ²)	Pemb. dial	Beban P (kg)	= P/A (kg/cm ²)	Pemb. dial	Beban P (kg)	= P/A (kg/cm ²)
1	2	3	4	5	6	7	8	9	10	11	12	13	14
0	0	0.00	1.000	12.44	0	0.000	0.000	0	0.000	0.000	0	0.000	0.000
20	0.02	0.16	0.998	12.42	95	15.675	1.262	100	16.500	1.328	110	18.150	1.461
40	0.04	0.32	0.997	12.40	120	19.800	1.597	105	17.325	1.397	138	22.770	1.836
60	0.06	0.48	0.995	12.38	151	24.915	2.012	150	21.450	1.732	165	27.225	2.199
80	0.08	0.64	0.994	12.36	180	29.700	2.403	140	23.100	1.869	185	30.525	2.469
100	0.10	0.80	0.992	12.34	190	31.350	2.540	155	25.245	2.046	205	33.825	2.741
120	0.12	0.96	0.990	12.32	200	33.000	2.678	165	27.225	2.210	220	36.300	2.946
140	0.14	1.12	0.989	12.30	210	34.650	2.817	175	35.475	2.884	230	37.950	3.085
160	0.16	1.28	0.987	12.28	216	35.640	2.902	221	36.465	2.969	241	39.765	3.238
180	0.18	1.44	0.986	12.26	220	36.300	2.961	230	37.950	3.095	248	40.920	3.337
200	0.20	1.60	0.984	12.24	222	36.630	2.992	236	38.940	3.181	254	41.910	3.424
220	0.22	1.76	0.982	12.22	226	37.290	3.051	245	40.425	3.308	256	42.240	3.456
240	0.24	1.92	0.981	12.20	228	37.620	3.083	260	42.900	3.516	262	43.230	3.543
260	0.26	2.08	0.979	12.18	230	37.950	3.116	265	43.725	3.590	268	44.220	3.630
280	0.28	2.24	0.977	12.16	232	38.280	3.148	272	44.880	3.690	269	44.585	3.650
300	0.30	2.40	0.976	12.14	238	39.270	3.234	279	46.035	3.792	271	44.715	3.683
320	0.32	2.56	0.974	12.12	247	40.755	3.362	287	46.365	3.825	275	45.375	3.743
340	0.34	2.72	0.973	12.10	245	40.425	3.341	280	46.200	3.818	280	46.200	3.818
360	0.36	2.88	0.971	12.08				278	45.870	3.797	290	47.850	3.961
380	0.38	3.04	0.969	12.06							295	48.675	4.036
400	0.40	3.20	0.968	12.04							300	49.500	4.111
420	0.42	3.36	0.966	12.02							305	50.325	4.186
440	0.44	3.52	0.965	12.00							310	51.150	4.262
460	0.46	3.70	0.963	11.98							315	51.975	4.338
480	0.48	3.86	0.961	11.96							320	52.800	4.414
500	0.50	4.02	0.960	11.94							322	53.130	4.449
520	0.52	4.18	0.958	11.92							323	53.295	4.471
540	0.54	4.34	0.957	11.90							324	53.460	4.492
560	0.56	4.50	0.955	11.88							326	53.790	4.527
580	0.58	4.66	0.953	11.86							328	54.120	4.563
600	0.60	4.82	0.952	11.84							328	54.120	4.571
620	0.62	4.98	0.950	11.82							327	53.955	4.564



LABORATORIUM MEKANIKA TANAH

FAKULTAS TEKNIK SIPIL DAN PERENCANAAN

UNIVERSITAS ISLAM INDONESIA

Jl. Kaliurang KM 14,5 Telp. (0274) 895042, 895707, fax 895330 Yogyakarta 55584

TRIAXIAL TEST

Project : Final Assignment
 Location : Cepagan, Pekalongan, Jawa Tengah
 Description of soil : Silty Clay

Depth : 1,20 meter
 Date : September 1, 2006
 Tested by : Purwadi

Grafik Tegangan-Regangan

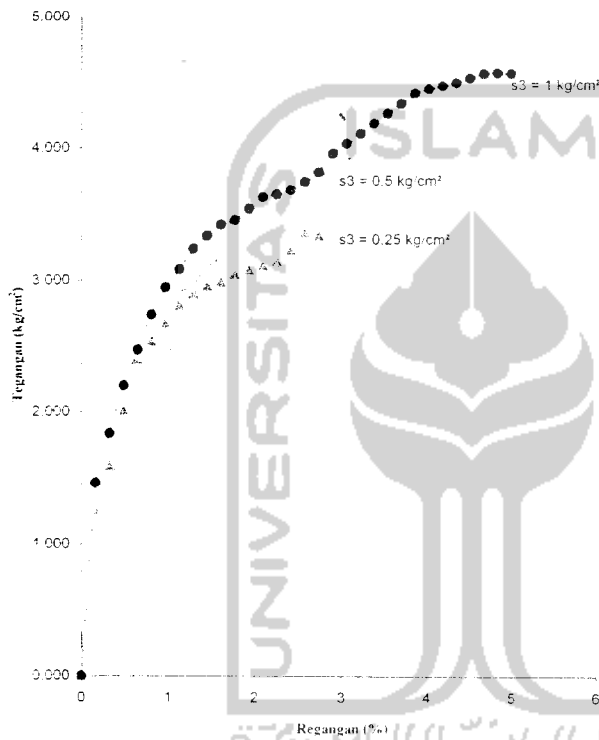

Kadar air

No. Pengujian	1	2
Berat container, gr	0	0
Berat cont. + tanah basah, gr	0	0
Berat cont. + tanah kering, gr	0	0
Kadar air	0.00	0.00
Kadar air rata-rata	27.71	

No. Pengujian	1	2	3
Diameter benda uji, cm	3.98	3.83	3.79
Tinggi benda uji, cm	7.60	7.70	7.64
Luas mula-mula, cm ²	12.44	11.52	11.28
Volume benda uji, cm ³	94.55	88.71	86.19
Berat benda uji, gr	146.12	146.28	146.58
Berat vol.tanah, gr/cm ³	1.545	1.649	1.701
Kalibrasi	0.165		

Brt vol. basah, gr/cm ³	1.545	1.649	1.701
Brt vol. kering, gr/cm ³	1.210	1.291	1.332

σ_3	0.25	0.5	1.0
P/A	3.362	3.825	4.571
$(\sigma_1 + \sigma_3)/2$	3.612	4.325	5.571
$(\sigma_1 - \sigma_3)/2$	1.931	2.413	3.285
$(\sigma_1 + \sigma_3)/2$	1.681	1.913	2.285

Sudut gesek dalam (°)	26.74
Nilai kohesi (kg/cm ²)	0.90

Diagram Mohr

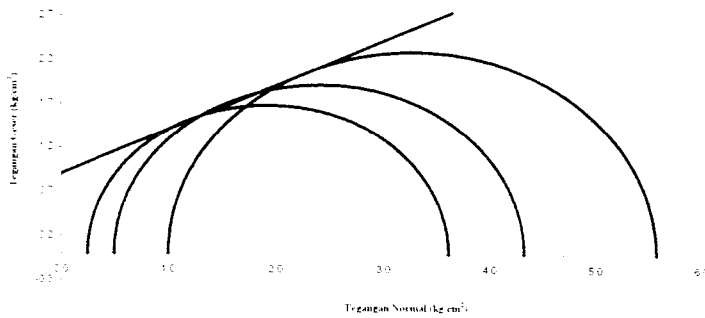

Diperiksa Oleh :

Dr. Ir. Eddy Purwanto, CES, DEA



LABORATORIUM MEKANIKA TANAH
FAKULTAS TEKNIK SIPIL DAN PERENCANAAN
UNIVERSITAS ISLAM INDONESIA

Jl. Kaliurang KM 14,5 Telp. (0274) 895042, 895707, fax 895330 Yogyakarta 55584

TRIAxIAL TEST

Project : Tugas Akhir

Location : Cepagan, Pekalongan, Jawa Tengah

Description of soil : Campuran Kapur Karbid 1,5% (Pemeraman 14 hari)

Depth : 1,20 meter

Date : September 1, 2006

Tested by : Purwadi

Diameter benda uji	3.98 cm
Tinggi benda uji	7.50 cm
Luas mula-mula	12.44 cm ²
Volume benda uji	93.31 cm ³
Berat benda uji	gram
Berat volume tanah	1.583 gr/cm ³
Kalibrasi	0.165

Kadar air	27.71
-----------	-------

Pembacaan beban

Regangan		Luas benda uji			Tekanan sel = 0,25 kg/cm ²			Tekanan sel = 0,5 kg/cm ²			Tekanan sel = 1,00 kg/cm ²		
Pemb. dial	$\frac{L}{L_0}$	koreksi L/L	A=luas	Pemb. dial	Beban P	$\sigma = P/A$	Pemb. dial	Beban P	$\sigma = P/A$	Pemb. dial	Beban P	$\sigma = P/A$	
(a)	(cm)	(%)	1-e	(A ₀ [4])	(kg)	(kg/cm ²)	(kg)	(kg/cm ²)	(kg/cm ²)	(kg)	(kg/cm ²)	(kg/cm ²)	
1	2	3	4	5	6	7	8	9	10	11	12	13	14
0	0	0.00	1.000	12.44	0	0.000	0.000	0	0.000	0.000	0	0.000	0.000
20	0.02	0.16	0.998	12.42	60	9.900	0.797	64	10.560	0.850	65	10.725	0.863
40	0.04	0.32	0.997	12.40	95	15.675	1.264	105	17.325	1.397	110	18.150	1.464
60	0.06	0.48	0.995	12.38	135	22.275	1.799	150	24.750	1.999	155	25.575	2.066
80	0.08	0.64	0.994	12.36	170	28.050	2.269	195	32.175	2.603	185	30.525	2.469
100	0.10	0.80	0.992	12.34	195	32.175	2.607	230	37.950	3.075	220	36.300	2.941
120	0.12	0.96	0.990	12.32	210	34.650	2.812	255	42.075	3.415	255	42.075	3.415
140	0.14	1.12	0.989	12.30	225	37.125	3.018	272	44.880	3.648	290	47.850	3.890
160	0.16	1.29	0.987	12.28	250	37.950	3.090	285	47.025	3.829	310	51.150	4.165
180	0.18	1.45	0.986	12.26	232	38.280	3.122	295	48.675	3.970	340	56.100	4.575
200	0.20	1.61	0.984	12.24	253	38.445	3.141	298	49.170	4.017	350	57.750	4.718
220	0.22	1.77	0.982	12.22	238	39.270	3.213	301	49.665	4.064	358	59.070	4.833
240	0.24	1.93	0.981	12.20	232	38.280	3.137	305	50.325	4.125	360	59.400	4.868
260	0.26	2.09	0.979	12.18				306	50.490	4.145	365	60.225	4.944
280	0.28	2.25	0.977	12.16				307	50.655	4.165	380	62.700	5.156
300	0.30	2.41	0.976	12.14				309	50.985	4.199	388	64.020	5.273
320	0.32	2.57	0.974	12.12				310	51.150	4.220	395	65.175	5.377
340	0.34	2.73	0.973	12.10				315	51.975	4.295	405	66.825	5.522
360	0.36	2.89	0.971	12.08				318	52.470	4.343	412	67.980	5.627
380	0.38	3.05	0.969	12.06				322	53.130	4.405	419	69.135	5.732
400	0.40	3.22	0.968	12.04				320	52.800	4.385	421	69.465	5.769
420	0.42	3.38	0.966	12.02							425	70.125	5.834
440	0.44	3.54	0.965	12.00							430	70.950	5.912
460	0.46	3.70	0.963	11.98							431	71.115	5.936
480	0.48	3.86	0.961	11.96							435	71.775	6.001
500	0.50	4.02	0.960	11.94							437	72.105	6.038
520	0.52	4.18	0.958	11.92							440	72.600	6.090
540	0.54	4.34	0.957	11.90							442	72.930	6.128
560	0.56	4.50	0.955	11.88							447	73.755	6.208
580	0.58	4.66	0.953	11.86							450	74.250	6.260
600	0.60	4.82	0.952	11.84							451	74.415	6.285
620	0.62	4.98	0.950	11.82							451	74.415	6.295
640	0.64	5.14	0.949	11.80							450	74.250	6.292



LABORATORIUM MEKANIKA TANAH

FAKULTAS TEKNIK SIPIL DAN PERENCANAAN

UNIVERSITAS ISLAM INDONESIA

Jl. Kaliurang KM 14,5 Telp. (0274) 895042, 895707, fax 895330 Yogyakarta 55584

TRIAxIAL TEST

Project : Final Assignment
 Location : Cepagan, Pekalongan, Jawa Tengah
 Description of soil : Silty Clay + karbid 1,5% 14hr(1)

Depth : 1,20 meter
 Date : September 1, 2006
 Tested by : Purwadi

Grafik Tegangan-Regangan

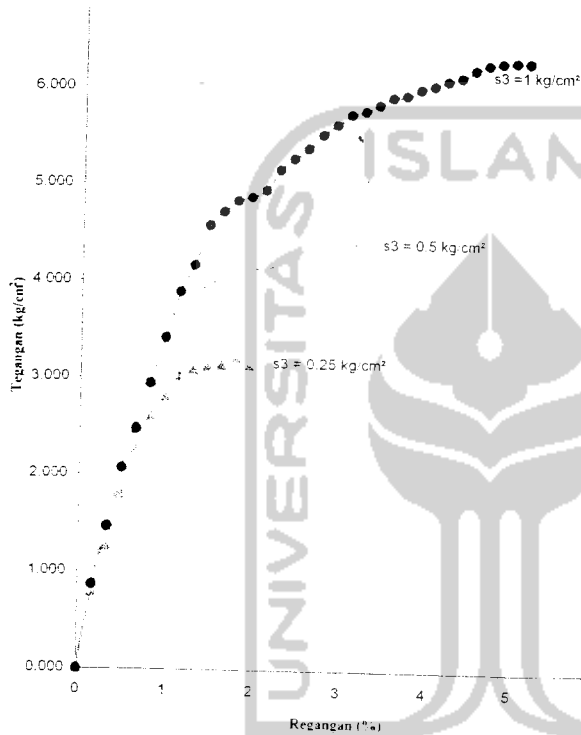

Kadar air

No. Pengujian	1	2
Berat container, gr	0	0
Berat cont. + tanah basah, gr	0	0
Berat cont. + tanah kering, gr	0	0
Kadar air	0,00	0,00
Kadar air rata-rata	27,71	

No. Pengujian	1	2	3
Diameter benda uji, cm	3,98	3,83	3,79
Tinggi benda uji, cm	7,60	7,54	7,42
Luas mula-mula, cm ²	12,44	11,52	11,28
Volume benda uji, cm ³	94,55	86,87	83,71
Berat benda uji, gr	146,25	146,35	147,70
Berat vol.tanah, gr/cm ³	1,547	1,685	1,764
Kalibrasi	0,165		

Brt vol. basah, gr/cm ³	1,547	1,685	1,764
Brt vol. kering, gr/cm ³	1,211	1,319	1,382

	0,25	0,5	1,0
$\sigma_1 - P/A$	3,213	4,405	6,295
$\sigma_1 - \sigma_3$	3,463	4,905	7,295
$(\sigma_1 + \sigma_3)/2$	1,857	2,703	4,148
$(\sigma_1 - \sigma_3)/2$	1,607	2,203	3,148

Sudut gesek dalam (°)	40,31
Nilai kohesi (kg/cm ²)	0,57

Diagram Mohr

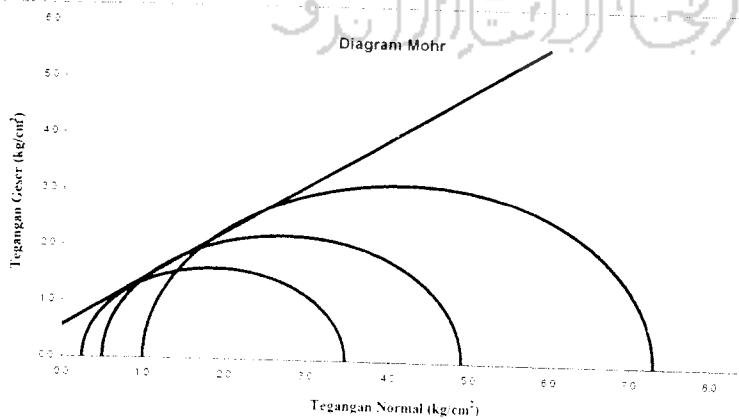

Diperiksa Oleh :

Dr. Ir. Edy Purwanto, CES, DEA



LABORATORIUM MEKANIKA TANAH
FAKULTAS TEKNIK SIPIL DAN PERENCANAAN
UNIVERSITAS ISLAM INDONESIA

Jl. Kaliurang KM 14,5 Telp. (0274) 895042, 895707, fax 895330 Yogyakarta 55584

TRIAxIAL TEST

Project : Tugas Akhir

Depth : 1,20 meter

Location : Cepagan, Pekalongan, Jawa Tengah

Date : September 1, 2006

Description of soil : Campuran Kapur Karbid 1,5% (Pemeraman 14 hari)2

Tested by : Purwadi

Diameter benda uji	3.98 cm
Tinggi benda uji	7.50 cm
Luas mula-mula	12.44 cm ²
Volume benda uji	93.31 cm ³
Berat benda uji	gram
Berat volume tanah	1.546 gr/cm ³
Kalibrasi	0.165

Kadar air	27.71
-----------	-------

Pembacaan beban

Regangan					Tekanan sel = 0.25 kg/cm ²			Tekanan sel = 0.5 kg/cm ²			Tekanan sel = 1.00 kg/cm ²		
Pemb. dial	L = a/10 ⁻³	ε = ΔL/L (%)	koreksi L = 1-ε	A=luas terkoraksi [A ₀ (1-ε)]	Pemb. dial	Beban P (kg)	= P/A (kg/cm ²)	Pemb. dial	Beban P (kg)	= P/A (kg/cm ²)	Pemb. dial	Beban P (kg)	= P/A (kg/cm ²)
1	2	3	4	5	6	7	8	9	10	11	12	13	14
0	0	0.00	1.000	12.44	0	0.000	0.000	0	0.000	0.000	0	0.000	0.000
20	0.02	0.16	0.998	12.42	70	11.550	0.930	85	11.025	1.129	110	18.150	1.461
40	0.04	0.32	0.997	12.40	78	12.870	1.038	140	23.100	1.865	160	26.400	2.129
60	0.06	0.48	0.995	12.38	81	13.365	1.079	180	29.700	2.399	195	32.175	2.599
80	0.08	0.64	0.994	12.36	85	14.025	1.135	205	33.825	2.736	220	36.300	2.937
100	0.10	0.80	0.992	12.34	88	14.520	1.177	220	36.300	2.941	245	40.425	3.276
120	0.12	0.96	0.990	12.32	95	15.675	1.272	250	39.900	3.080	265	43.725	3.549
140	0.14	1.12	0.989	12.30	98	16.170	1.315	255	38.775	3.122	280	46.200	3.756
160	0.16	1.28	0.988	12.28	100	16.700	1.344	244	40.260	3.223	291	48.075	3.910
180	0.18	1.44	0.986	12.26	101	16.865	1.359	254	41.910	3.428	300	49.800	4.057
200	0.20	1.60	0.984	12.24	104	17.160	1.402	263	43.395	3.525	310	51.300	4.179
220	0.22	1.76	0.982	12.22	105	17.325	1.418	270	44.550	3.625	320	52.800	4.320
240	0.24	1.92	0.981	12.20	106	17.685	1.447	275	45.705	3.726	325	54.120	4.436
260	0.26	2.08	0.979	12.18	108	17.820	1.463	281	46.365	3.806	335	55.275	4.538
280	0.28	2.24	0.977	12.16	109	17.985	1.479	285	47.025	3.867	340	56.100	4.613
300	0.30	2.40	0.976	12.14	110	18.150	1.495	290	47.850	3.941	348	57.420	4.729
320	0.32	2.56	0.974	12.12	111	18.315	1.511	294	48.510	4.002	355	58.575	4.835
340	0.34	2.72	0.973	12.10	114	18.810	1.554	297	49.005	4.050	365	60.225	4.977
360	0.36	2.88	0.971	12.08	115	18.975	1.571	301	49.665	4.111	370	61.050	5.053
380	0.38	3.04	0.969	12.06	118	19.470	1.614	308	50.820	4.214	374	61.710	5.116
400	0.40	3.20	0.968	12.04	125	20.625	1.715	310	51.150	4.248	379	62.535	5.193
420	0.42	3.36	0.966	12.02	129	21.285	1.771	316	52.140	4.337	385	63.525	5.284
440	0.44	3.52	0.965	12.00	135	22.275	1.856	321	52.965	4.413	390	64.350	5.362
460	0.46	3.70	0.963	11.98	160	26.400	2.203	325	53.625	4.476	394	65.010	5.426
480	0.48	3.86	0.961	11.96	180	29.700	2.485	326	53.790	4.497	398	65.670	5.490
500	0.50	4.02	0.960	11.94	201	33.165	2.777	327	53.955	4.518	400	66.000	5.527
520	0.52	4.18	0.958	11.92	235	38.775	3.253	328	54.120	4.540	405	66.825	5.606
540	0.54	4.34	0.957	11.90	245	40.425	3.397	330	54.450	4.575	410	67.650	5.684
560	0.56	4.50	0.955	11.88	246	40.590	3.416	331	54.615	4.597	413	68.145	5.736
580	0.58	4.66	0.953	11.86	248	40.920	3.450	332	54.780	4.618	417	68.805	5.801
600	0.60	4.82	0.952	11.84	278	45.870	3.874	335	55.275	4.668	420	69.300	5.853
620	0.62	4.98	0.950	11.82	249	41.085	3.476	336	55.440	4.690	424	69.960	5.918
640	0.64	5.14	0.949	11.80				338	55.770	4.726	426	70.290	5.956
660	0.66	5.31	0.947	11.78				341	56.265	4.776	428	70.620	5.994
680	0.68	5.47	0.945	11.76				343	56.595	4.812	431	71.115	6.047
700	0.70	5.63	0.944	11.74				342	56.430	4.806	434	71.610	6.099
720	0.72	5.79	0.942	11.72							438	72.270	6.166
740	0.74	5.95	0.941	11.70							440	72.600	6.205
760	0.76	6.11	0.939	11.68							444	73.260	6.272
780	0.78	6.27	0.937	11.66							445	73.425	6.297
800	0.80	6.43	0.936	11.64							446	73.590	6.322
820	0.82	6.59	0.934	11.62							444	73.260	6.304



LABORATORIUM MEKANIKA TANAH FAKULTAS TEKNIK SIPIL DAN PERENCANAAN UNIVERSITAS ISLAM INDONESIA

Jl. Kaliurang KM 14,5 Telp. (0274) 895042, 895707, fax 895330 Yogyakarta 55584

TRIAXIAL TEST

Project : Final Assignment
 Location : Cepagan, Pekalongan, Jawa Tengah
 Description of soil : Silty Clay + Karbid 1,5% 14hr(2)

Depth : 1,20 meter
 Date : September 1, 2006
 Tested by : Purwadi

Kadar air

No. Pengujian	1	2
Berat container, gr	0	0
Berat cont. + tanah basah, gr	0	0
Berat cont. + tanah kering, gr	0	0
Kadar air	0.00	0.00
Kadar air rata-rata	27.71	

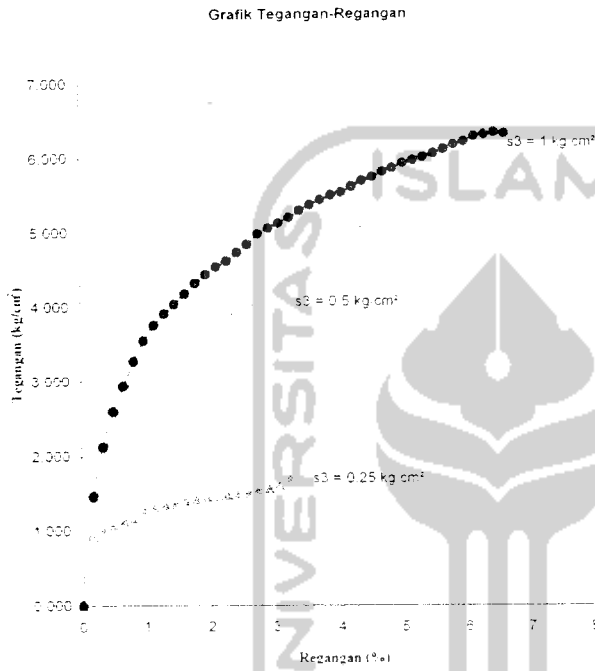

No. Pengujian	1	2	3
Diameter benda uji, cm	3.98	3.83	3.79
Tinggi benda uji, cm	7.60	7.70	7.64
Luas mula-mula, cm ²	12.44	11.52	11.28
Volume benda uji, cm ³	94.55	88.71	86.19
Berat benda uji, gr	141.83	143.91	144.27
Berat vol tanah, gr/cm ³	1.500	1.622	1.674
Kalibrasi	0.163		

Brt vol. basah, gr/cm ³	1.500	1.622	1.674
Brt vol. kering, gr/cm ³	1.175	1.270	1.311

σ_3	0.25	0.5	1.0
σ_1	3.874	4.812	6.272
σ_2	4.124	5.312	7.272
$\sigma_1 - \sigma_2$	2.187	2.906	4.136
$(\sigma_1 - \sigma_3) - \sigma_3$	1.957	2.406	3.136

Sudut gesek dalam (°)	39.13
Nilai kohesi (kg/cm ²)	0.71

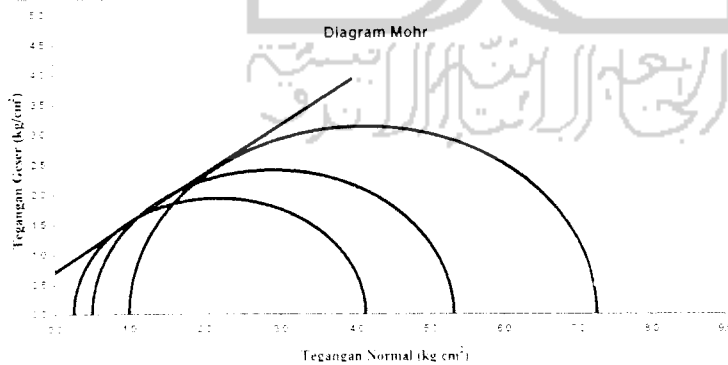

Diperiksa Oleh :

Dr. Ir. Edy Purwanto, CES, DEA

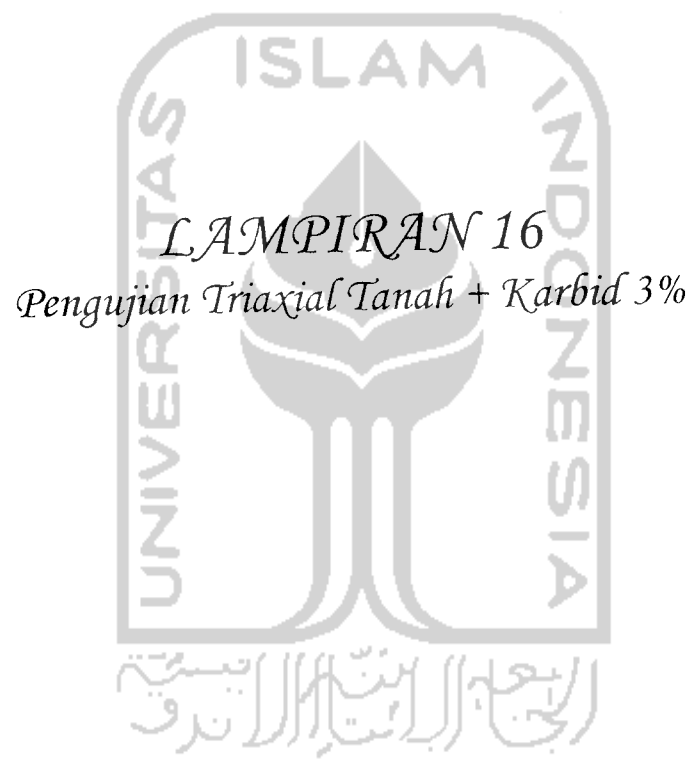

LAMPPIRAN 16

Pengujian Triaxial Tanah + Karbid 3%



LABORATORIUM MEKANIKA TANAH

FAKULTAS TEKNIK SIPIL DAN PERENCANAAN

UNIVERSITAS ISLAM INDONESIA

Jl. Kaliurang KM 14,5 Telp. (0274) 895042, 895707, fax 895330 Yogyakarta 55584

TRIAxIAL TEST

Project : Final Assignment
 Location : Cepagan, Pekalongan, Jawa Tengah
 Description of soil : Silty Clay 3% 3 hari (I)

Depth : 1,20 meter
 Date : September 1, 2006
 Tested by : Purwadi

Grafik Tegangan-Regangan

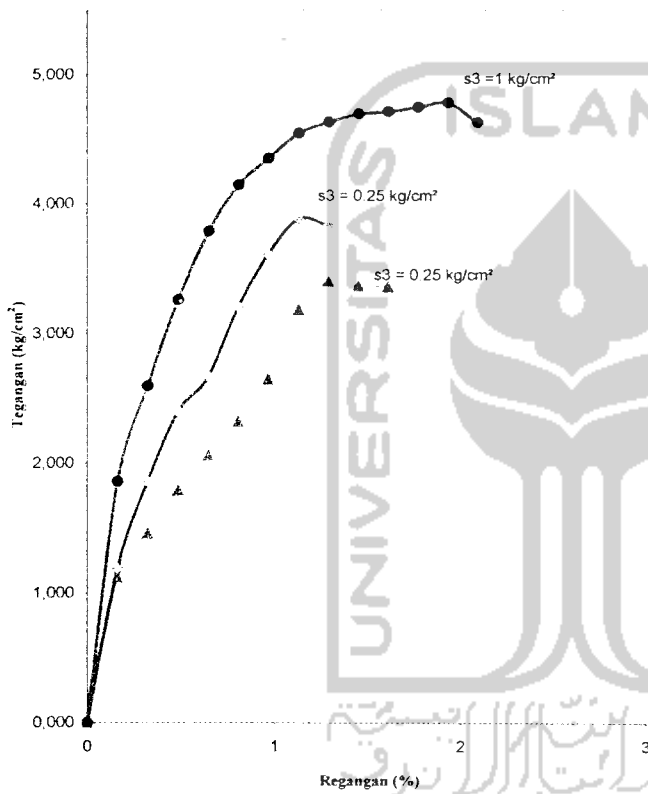

Kadar air

No Pengujian	1	2
Berat container, gr	0	0
Berat cont. + tanah basah, gr	0	0
Berat cont. + tanah kering, gr	0	0
Kadar air	0,00	0,00
Kadar air rata-rata	27,71	

No Pengujian	1	2	3
Diameter benda uji, cm	3,98	3,83	3,79
Tinggi benda uji, cm	7,60	7,70	7,64
Luas mula-mula, cm ²	12,44	11,52	11,28
Volume benda uji, cm ³	94,55	88,71	86,19
Berat benda uji, gr	145,49	145,65	148,26
Berat vol tanah, gr/cm ³	1,539	1,642	1,720
Kalibrasi	0,165		

Brt vol. basah, gr/cm ³	1,539	1,642	1,720
Brt vol. kering, gr/cm ³	1,205	1,286	1,347

	0,25	0,5	1,0
$\sigma_1 = \sigma_2 = \sigma_3$	3,413	3,890	4,787
$\sigma_1 = \sigma_2 + \sigma_3$	3,663	4,390	5,787
$(\sigma_1 + \sigma_3)/2$	1,956	2,445	3,394
$(\sigma_2 + \sigma_3)/2$	1,706	1,945	2,394

Sudut gesek dalam (°)	29,67
Nilai kohesi (kg/cm ²)	0,82

Diagram Mohr

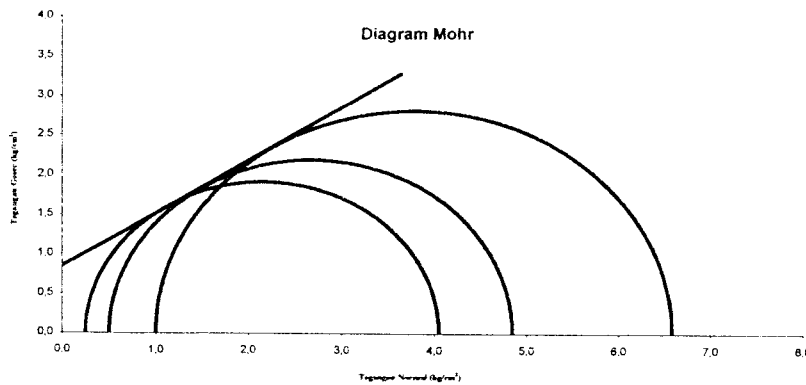

Diperiksa Oleh :

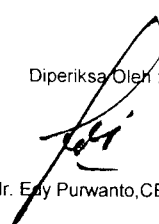
 Dr. Ir. Edy Purwanto, CES, DEA



LABORATORIUM MEKANIKA TANAH

FAKULTAS TEKNIK SIPIL DAN PERENCANAAN

UNIVERSITAS ISLAM INDONESIA

Jl. Kaliurang KM 14,5 Telp. (0274) 895042, 895707, fax 895330 Yogyakarta 55584

TRIAXIAL TEST

Project : Final Assignment
 Location : Cepagan, Pekalongan, Jawa Tengah
 Description of soil : Silty Clay 3% 3hari(2)

Depth : 1,20 meter
 Date : September 1, 2006
 Tested by : Purwadi

Grafik Tegangan-Regangan

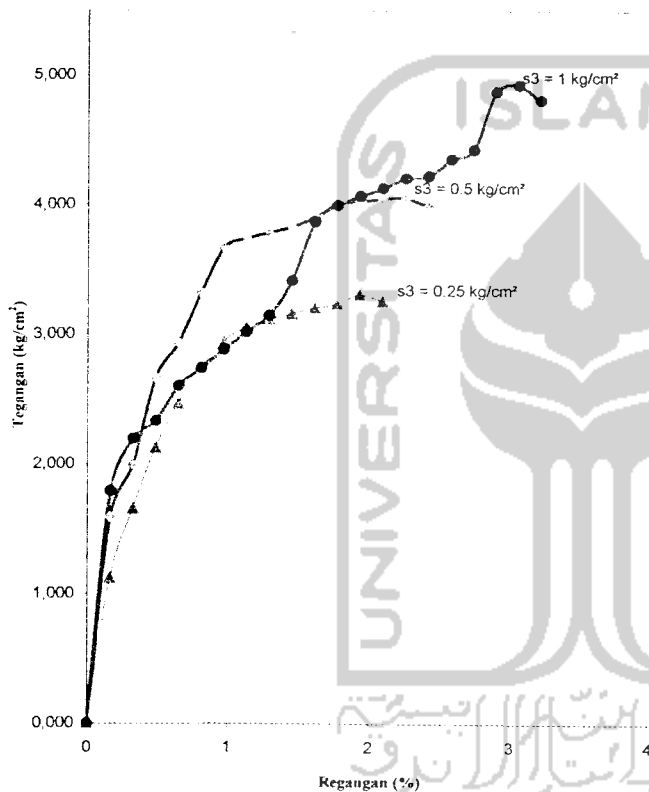

Kadar air

No. Pengujian	1	2
Berat container, gr	0	0
Berat cont. + tanah basah, gr	0	0
Berat cont. + tanah kering, gr	0	0
Kadar air	0,00	0,00
Kadar air rata-rata	27,71	

No. Pengujian	1	2	3
Diameter benda uji, cm	3,98	3,83	3,79
Tinggi benda uji, cm	7,60	7,70	7,64
Luas mula-mula, cm ²	12,44	11,52	11,28
Volume benda uji, cm ³	94,55	88,71	86,19
Berat benda uji, gr	146,12	146,28	146,58
Berat vol tanah, gr/cm ³	1,545	1,649	1,701
Kalibrasi	0,165		

Bra vol. basah, gr/cm ³	1,545	1,649	1,701
Bra vol. kering, gr/cm ³	1,210	1,291	1,332

σ_3	0,25	0,5	1,0
$\sigma_1 - P/A$	3,313	4,057	4,925
$\sigma_1 - \sigma_3$	3,563	4,557	5,925
$(\sigma_1 + \sigma_3)/2$	1,907	2,528	3,462
$(\sigma_1 - \sigma_3)/2$	1,657	2,028	2,462

Sudut gesek dalam ($^\circ$)	30,90
Nilai kohesi (kg/cm ²)	0,80

Diagram Mohr

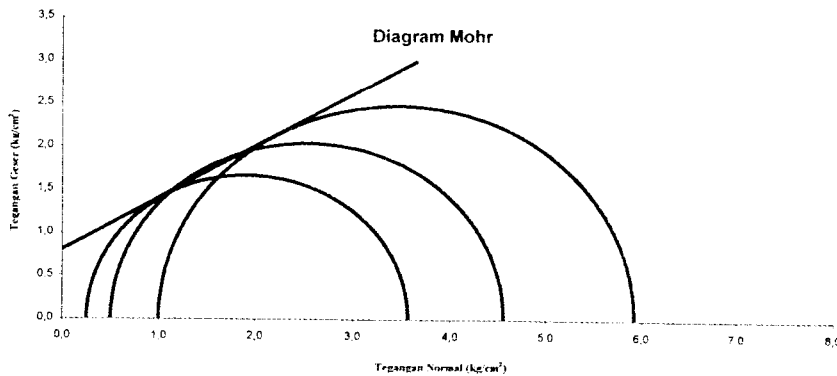

Diperiksa Oleh :

Dr. Ir. Edy Purwanto, CES, DEA



LABORATORIUM MEKANIKA TANAH
FAKULTAS TEKNIK SIPIL DAN PERENCANAAN
UNIVERSITAS ISLAM INDONESIA

Jl. Kaliurang KM 14,5 Telp. (0274) 895042, 895707, fax 895330 Yogyakarta 55584

TRIAXIAL TEST

Project : Final Assignment
Location : Cepagan, Pekalongan, Jawa Tengah
Description of soil : Silty Clay 3% 7hari(1)

Depth : 1,20 meter
Date : September 1, 2006
Tested by : Purwadi

Grafik Tegangan-Regangan

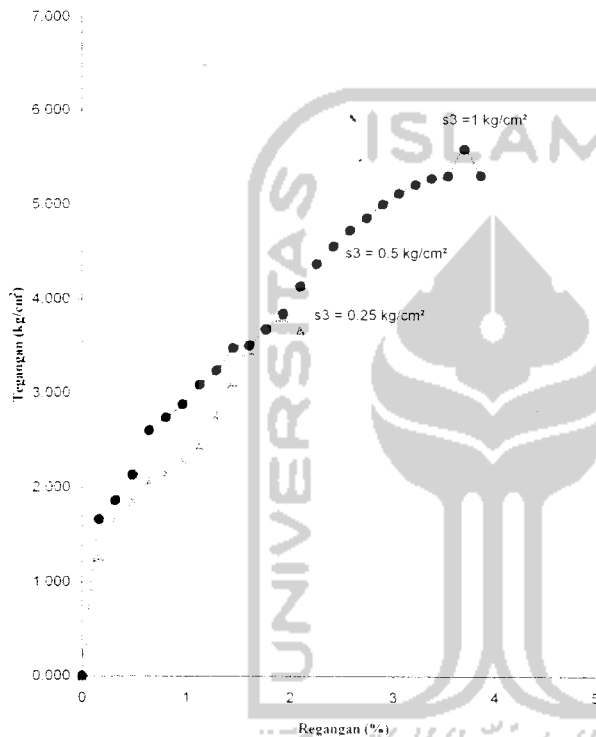

Kadar air

No. Pengujian	1	2
Berat container, gr	0	0
Berat cont. + tanah basah, gr	0	0
Berat cont. + tanah kering, gr	0	0
Kadar air	0.00	0.00
Kadar air rata-rata	27.71	

No. Pengujian	1	2	3
Diameter benda uji, cm	3.98	3.83	3.79
Tinggi benda uji, cm	7.60	7.70	7.64
Luas mula-mula, cm ²	12.44	11.52	11.28
Volume benda uji, cm ³	94.55	88.71	86.19
Berat benda uji, gr	145.72	145.92	146.16
Berat vol.tanah, gr/cm ³	1.541	1.645	1.696
Kalibrasi	0.165		

Brt vol. basah, gr/cm ³	1.541	1.645	1.696
Brt vol. kering, gr/cm ³	1.207	1.288	1.328

σ_3	0.25	0.5	1.0
$\sigma_1 = P/A$	3.800	4.349	5.578
$\sigma_1 = \sigma_2 + \sigma_3$	4.050	4.849	6.578
$(\sigma_1 + \sigma_3)/2$	2.150	2.674	3.789
$(\sigma_1 - \sigma_3)/2$	1.900	2.174	2.789

Sudut gesek dalam (°)	33.48
Nilai kohesi (kg/cm ²)	0.85

Diagram Mohr

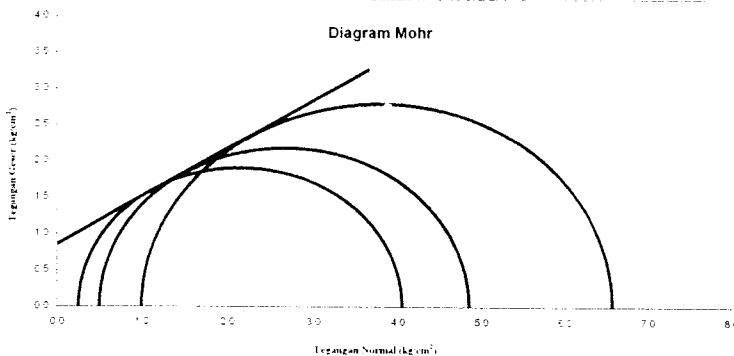

Diperiksa Oleh:

Dr. Ir. Edy Purwanto, CES, DEA



LABORATORIUM MEKANIKA TANAH
FAKULTAS TEKNIK SIPIL DAN PERENCANAAN
UNIVERSITAS ISLAM INDONESIA

Jl. Kaliurang KM 14,5 Telp. (0274) 895042, 895707, fax 895330 Yogyakarta 55584

TRIAxIAL TEST

Project : Final Assignment
 Location : Cepagan, Pekalongan, Jawa Tengah
 Description of soil : Silty Clay 3% 7 hari(2)

Depth : 1,20 meter
 Date : September 7, 2006
 Tested by : Purwadi

Grafik Tegangan-Regangan

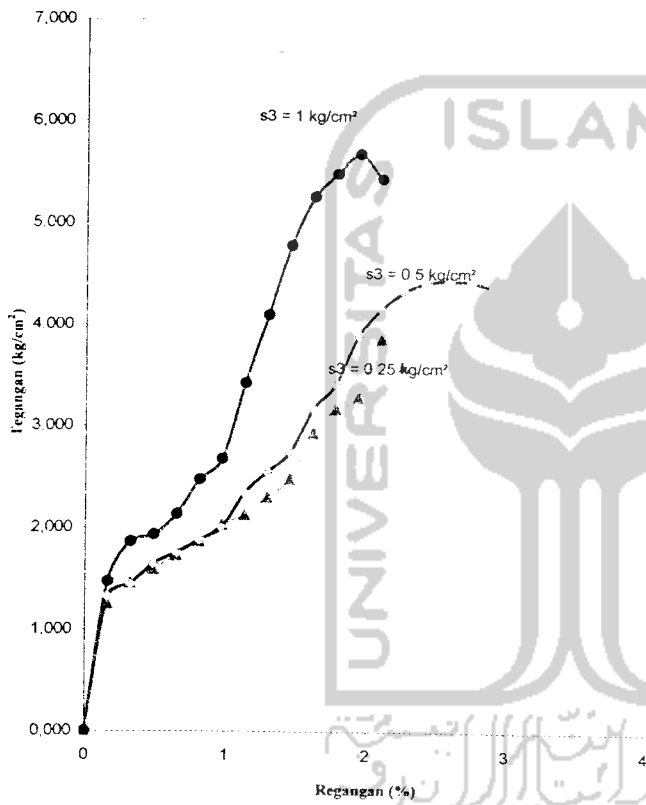

Kadar air

No Pengujian	1	2
Berat container, gr	0	0
Berat cont. + tanah basah, gr	0	0
Berat cont. + tanah kering, gr	0	0
Kadar air	0,00	0,00
Kadar air rata-rata	27,71	

No Pengujian	1	2	3
Diameter benda uji, cm	3,98	3,83	3,79
Tinggi benda uji, cm	7,60	7,70	7,64
Luas mula-mula, cm ²	12,44	11,52	11,28
Volume benda uji, cm ³	94,55	88,71	86,19
Berat benda uji, gr	145,15	146,12	146,25
Berat vol.tanah, gr/cm ³	1,535	1,647	1,697
Kalibrasi	0,165		

Brt vol. basah, gr/cm ³	1,535	1,647	1,697
Brt vol. kering, gr/cm ³	1,202	1,290	1,329

	0,25	0,5	1,0
P/A	3,861	4,438	5,680
$(\sigma_1 + \sigma_3)$	4,111	4,938	6,680
$(\sigma_1 + \sigma_3)/2$	2,180	2,719	3,840
$(\sigma_1 - \sigma_3)/2$	1,930	2,219	2,840

Sudut gesek dalam (°)	33,58
Nilai kohesi (kg/cm ²)	0,84

Diagram Mohr

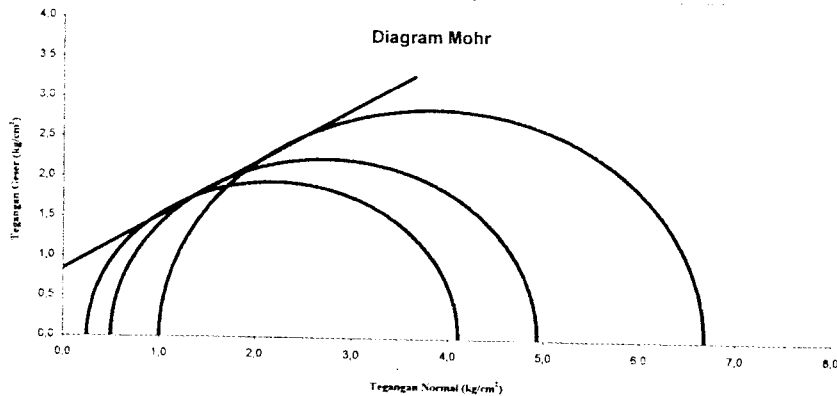

Diperiksa Oleh:

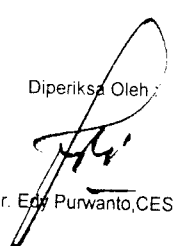
 Dr. Ir. Eddy Purwanto, CES, DEA



LABORATORIUM MEKANIKA TANAH
FAKULTAS TEKNIK SIPIL DAN PERENCANAAN
UNIVERSITAS ISLAM INDONESIA

Jl. Kaliurang KM 14,5 Telp. (0274) 895042, 895707, fax 895330 Yogyakarta 55584

TRIAxIAL TEST

Project : Final Assignment
Location : Cepagan, Pekalongan, Jawa Tengah
Description of soil : Silty Clay +karbid 3% 14hr(1)

Depth : 1,20 meter
Date : September 18, 2006
Tested by : Purwadi

Grafik Tegangan-Regangan

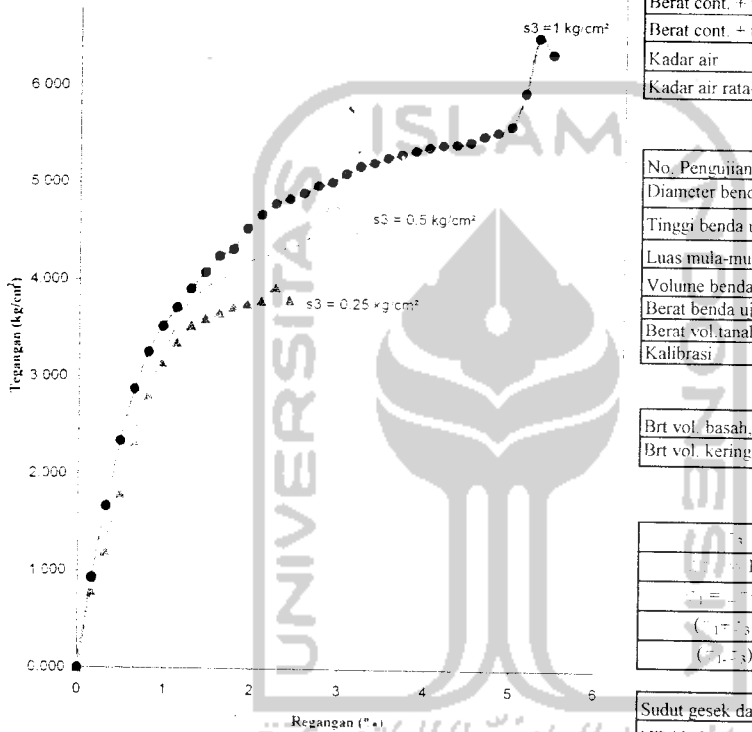

Kadar air

No. Pengujian	1	2
Berat container, gr	0	0
Berat cont. + tanah basah, gr	0	0
Berat cont. + tanah kering, gr	0	0
Kadar air	0.00	0.00
Kadar air rata-rata	27.71	

No. Pengujian	1	2	3
Diameter benda uji, cm	3.98	3.83	3.79
Tinggi benda uji, cm	7.60	7.54	7.42
Luas mula-mula, cm ²	12.44	11.52	11.28
Volume benda uji, cm ³	94.55	86.87	83.71
Berat benda uji, gr	146.66	147.55	150.15
Berat vol.tanah, gr/cm ³	1.551	1.699	1.794
Kalibrasi	0.163		

Brt vol. basah, gr/cm ³	1.551	1.699	1.794
Brt vol. kering, gr/cm ³	1.215	1.330	1.405

σ_3	0.25	0.5	1.0
$\sigma_1 - P/A$	3.935	4.780	6.513
$\sigma_1 - \sigma_3$	4.185	5.280	7.513
$(\sigma_1 + \sigma_3)/2$	2.217	2.890	4.256
$(\sigma_1 - \sigma_3)/2$	1.967	2.390	3.256

Sudut gesek dalam (°)	39.02
Nilai kohesi (kg/cm ²)	0.72

Diagram Mohr

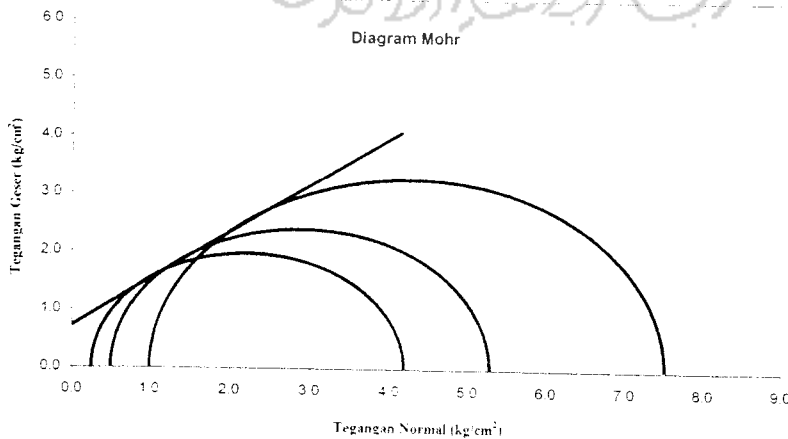

Diperiksa Oleh

Dr. Ir. Edy Purwanto, CES, DEA



LABORATORIUM MEKANIKA TANAH
FAKULTAS TEKNIK SIPIL DAN PERENCANAAN
UNIVERSITAS ISLAM INDONESIA

Jl. Kaliurang KM 14,5 Telp. (0274) 895042, 895707, fax 895330 Yogyakarta 55584

TRIAXIAL TEST

Project : Tugas Akhir
 Location : Cepagan, Pekalongan, Jawa Tengah
 Description of soil : Campuran Kapur Karbid 3% (Pemeraman 14 hari)2

Depth : 1,20 meter
 Date : September 8, 2006
 Tested by : Purwadi

Diameter benda uji	3.98 cm
Tinggi benda uji	7.50 cm
Luas mula-mula	12.44 cm ²
Volume benda uji	93.31 cm ³
Berat benda uji	gram
Berat volume tanah	1.657 gr/cm ³
Kalibrasi	0.165

Kadar air	27.71
-----------	-------

Pembacaan beban

Regangan		Luas benda uji			Tekanan sel = 0.25 kg/cm ²			Tekanan sel = 0.5 kg/cm ²			Tekanan sel = 1.00 kg/cm ²		
Pemb dial	$\frac{L}{a} \cdot 10^{-3}$	L.L	koreksi luas	A=luas terkoreksi	Pemb dial	Beban P (kg)	= P/A (kg/cm ²)	Pemb dial	Beban P (kg)	= P/A (kg/cm ²)	Pemb dial	Beban P (kg)	= P/A (kg/cm ²)
(a)	(cm)	(%)	L ₀	[A ₀ (1-ε)]									
0	0	0.00	1.000	12.44	0	0.000	0.000	0	0.000	0.000	0	0.000	0.000
20	0.02	0.16	0.998	12.42	85	14.025	1.129	90	14.850	1.196	125	20.625	1.660
40	0.04	0.32	0.997	12.40	130	21.450	1.730	120	19.800	1.597	155	25.575	2.062
60	0.06	0.48	0.993	12.38	148	24.420	1.972	160	26.400	2.152	170	28.050	2.266
80	0.08	0.64	0.991	12.36	195	32.175	2.603	195	32.175	2.603	204	33.660	2.723
100	0.10	0.80	0.992	12.32	215	35.475	2.875	225	37.125	3.008	214	35.310	2.861
120	0.12	0.96	0.990	12.32	230	37.950	3.080	245	40.425	3.287	247	40.725	3.308
140	0.14	1.12	0.989	12.30	255	42.175	3.432	265	43.725	3.533	263	43.725	3.533
160	0.16	1.28	0.987	12.28	285	47.250	3.848	280	46.200	3.762	270	44.550	3.652
180	0.18	1.44	0.986	12.26	241	39.675	3.245	290	46.800	3.905	290	47.850	3.905
200	0.20	1.60	0.984	12.24	251	41.475	3.389	298	49.170	4.071	301	49.668	4.071
220	0.22	1.76	0.982	12.22	268	44.220	3.618	305	50.325	4.178	320	52.800	4.320
240	0.24	1.92	0.981	12.20	282	47.970	3.933	310	51.150	4.192	325	53.625	4.395
260	0.26	2.08	0.979	12.18				315	51.975	4.261	333	53.275	4.358
280	0.28	2.24	0.977	12.16				320	52.800	4.342	340	56.100	4.615
300	0.30	2.40	0.976	12.14				325	53.295	4.390	348	57.420	4.729
320	0.32	2.56	0.974	12.12				324	53.460	4.411	355	58.575	4.833
340	0.34	2.72	0.973	12.10				325	53.625	4.431	360	59.400	4.909
360	0.36	2.88	0.971	12.08				327	53.985	4.466	371	61.215	5.067
380	0.38	3.04	0.969	12.06				328	54.120	4.487	374	61.710	5.116
400	0.40	3.20	0.968	12.04				319	52.635	4.371	380	62.700	5.207
420	0.42	3.36	0.966	12.02				312	51.480	4.282	387	63.855	5.312
440	0.44	3.52	0.965	12.00				310	51.150	4.262	394	65.010	5.417
460	0.46	3.68	0.963	11.98							394	65.010	5.426
480	0.48	3.84	0.961	11.96							397	65.505	5.477
500	0.50	4.00	0.960	11.94							401	66.165	5.541
520	0.52	4.16	0.958	11.92							408	67.320	5.647
540	0.54	4.32	0.957	11.90							415	68.475	5.754
560	0.56	4.48	0.955	11.88							416	68.640	5.777
580	0.58	4.64	0.953	11.86							417	68.805	5.801
600	0.60	4.80	0.952	11.84							440	72.600	6.131
620	0.62	4.96	0.950	11.82							418	68.970	5.835



LABORATORIUM MEKANIKA TANAH

FAKULTAS TEKNIK SIPIL DAN PERENCANAAN

UNIVERSITAS ISLAM INDONESIA

Jl. Kaliurang KM 14,5 Telp. (0274) 895042, 895707, fax 895330 Yogyakarta 55584

TRIAXIAL TEST

Project : Final Assignment
 Location : Cepagan, Pekalongan, Jawa Tengah
 Description of soil : Silty Clay + Karbid 3% 14hr(2)

Depth : 1,20 meter
 Date : September 8, 2006
 Tested by : Purwadi

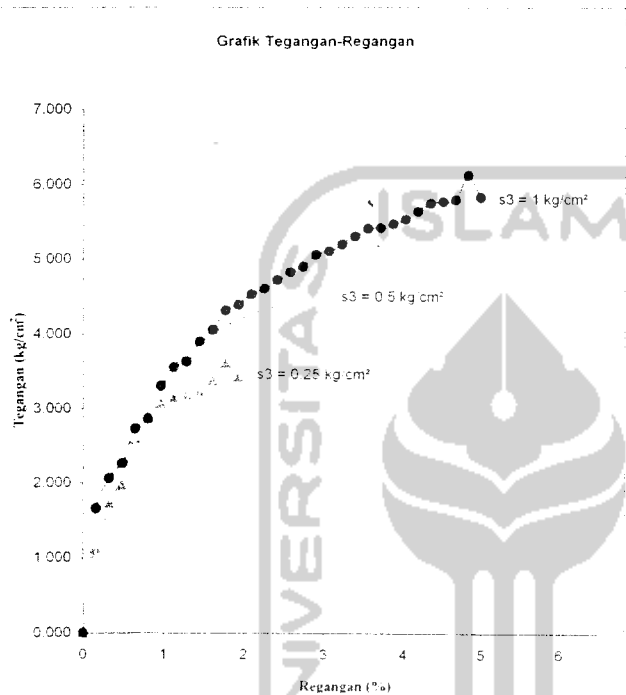

Kadar air

No. Pengujian	1	2
Berat container, gr	0	0
Berat cont. + tanah basah, gr	0	0
Berat cont. + tanah kering, gr	0	0
Kadar air	0.00	0.00
Kadar air rata-rata	27.71	

No. Pengujian	1	2	3
Diameter benda uji, cm	3.98	3.83	3.79
Tinggi benda uji, cm	7.60	7.70	7.64
Luas mula-mula, cm ²	12.44	11.52	11.28
Volume benda uji, cm ³	94.55	88.71	86.19
Berat benda uji, gr	150.19	151.17	154.57
Berat vol.tanah, gr/cm ³	1.588	1.704	1.793
Kahbrasi	0.165		

Brt vol. basah, gr/cm ³	1.588	1.704	1.793
Brt vol. kering, gr/cm ³	1.244	1.334	1.404

s	0.25	0.5	1.0
1/7A	3.073	4.487	6.131
1/7B	3.868	4.987	7.131
A (1/3) 2	2.039	2.744	4.066
B (1/3) 2	1.809	2.277	3.066

Sudut gesek dalam (°)	38.72
Nilai kohesi (kg/cm ²)	0.65

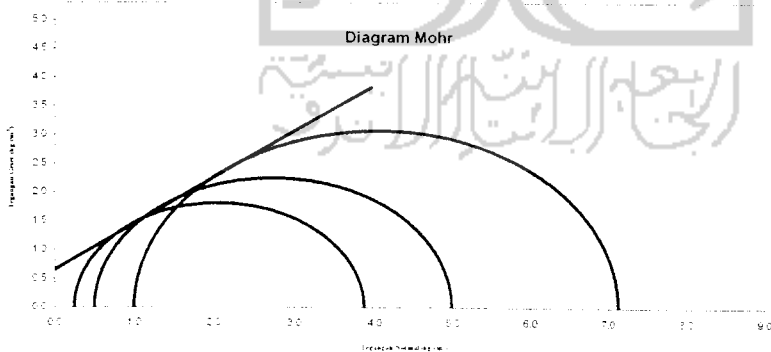

Diperiksa Oleh :

Dr. Ir. Edy Purwanto, CES, DEA



LAMPPIRAN 17

Pengujian Triaxial Tanah + Karbid 4.5%



LABORATORIUM MEKANIKA TANAH

FAKULTAS TEKNIK SIPIL DAN PERENCANAAN

UNIVERSITAS ISLAM INDONESIA

Jl. Kaliurang KM 14,5 Telp. (0274) 895042, 895707, fax 895330 Yogyakarta 55584

TRIAXIAL TEST

Project : Final Assignment
 Location : Cepagan, Pekalongan, Jawa Tengah
 Description of soil : Silty Clay 4.5% 3hari(1)

Depth : 1,20 meter
 Date : September 1, 2006
 Tested by : Purwadi

Grafik Tegangan-Regangan

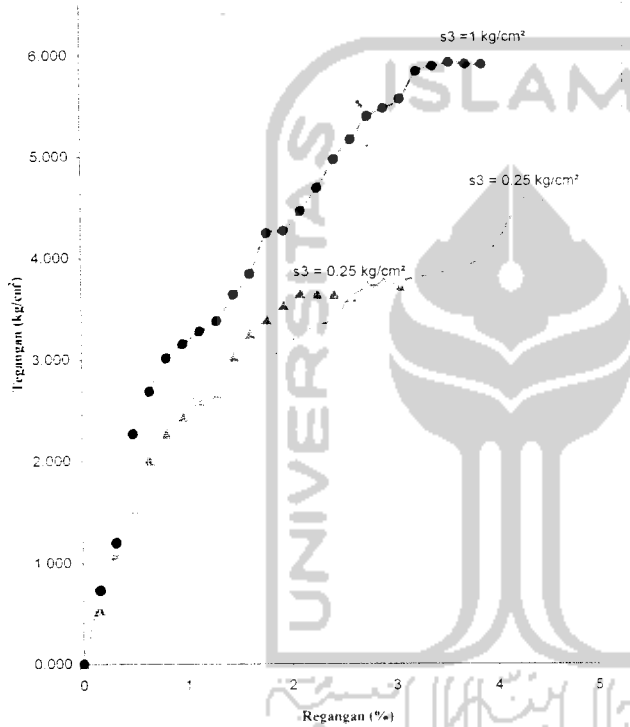

Kadar air

No. Pengujian	1	2
Berat container, gr	0	0
Berat cont. + tanah basah, gr	0	0
Berat cont. + tanah kering, gr	0	0
Kadar air	0.00	0.00
Kadar air rata-rata	27.71	

No. Pengujian	1	2	3
Diameter benda uji, cm	3.98	3.83	3.79
Tinggi benda uji, cm	7.60	7.70	7.64
Luas mula-mula, cm ²	12.44	11.52	11.28
Volume benda uji, cm ³	94.55	88.71	86.19
Berat benda uji, gr	145.49	145.65	148.26
Berat vol.tanah, gr/cm ³	1.539	1.642	1.720
Kalibrasi	0.165		

Brt vol. basah, gr/cm ³	1.539	1.642	1.720
Brt vol. kering, gr/cm ³	1.205	1.286	1.347

σ_3	0.25	0.5	1.0
$\sigma_1 - \sigma_3$	3.756	4.631	5.912
$(\sigma_1 + \sigma_3)$	4.006	5.131	6.912
$(\sigma_1 + \sigma_3)/2$	2.128	2.815	3.956
$(\sigma_1 - \sigma_3)/2$	1.878	2.315	2.956

Sudut gesek dalam (ϕ)	34.17
Nilai kohesi (c) (kg/cm ²)	0.84

Diagram Mohr

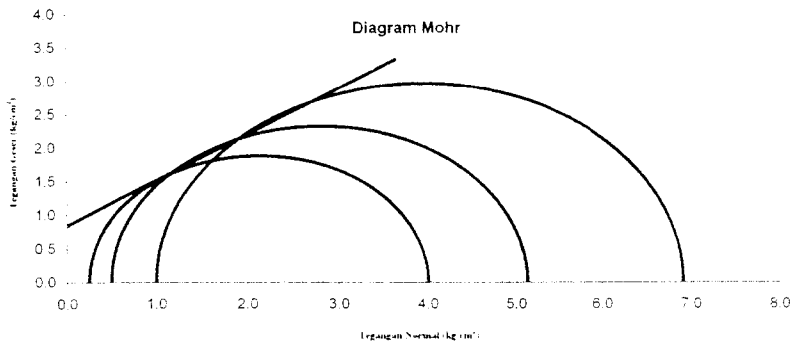

Diperiksa Oleh:

Dr. Ir. Eddy Purwanto, CES, DEA



LABORATORIUM MEKANIKA TANAH
FAKULTAS TEKNIK SIPIL DAN PERENCANAAN
UNIVERSITAS ISLAM INDONESIA

Jl. Kaliurang KM 14,5 Telp. (0274) 895042, 895707, fax 895330 Yogyakarta 55584

TRIAxIAL TEST

Project : Tugas Akhir
 Location : Cepagan, Pekalongan, Jawa Tengah
 Description of soil : Campuran Kapur Karbid 4,5% (Pemeraman 3 hari)2

Depth : 1,20 meter
 Date : September 1, 2006
 Tested by : Purwadi

Diameter benda uji	3.98 cm
Tinggi benda uji	7.50 cm
Luas mula-mula	12.44 cm ²
Volume benda uji	93.31 cm ³
Berat benda uji	gram
Berat volume tanah	1.567 gr/cm ³
Kalibrasi	0.165

Kadar air 27.71

Pembacaan beban

Regangan		Luas benda uji			Tekanan sel = 0.25 kg/cm ²			Tekanan sel = 0.5 kg/cm ²			Tekanan sel = 1.00 kg/cm ²		
Pemb. dial	L = a ² · 10 ⁻³	kor. L	A=luas	Pemb. dial	Beban P	= P · A	Pemb. dial	Beban P	= P · A	Pemb. dial	Beban P	= P · A	
(a)	(cm)	(%)	terkor. L-c	(A-cm ²)	(kg)	(kg/cm ²)	(a)	(kg)	(kg/cm ²)	(a)	(kg)	(kg/cm ²)	
1	2	3	4	5	6	7	8	9	10	11	12	13	14
0	0	0.00	1.000	12.44	0	0.000	0.000	0	0.000	0.000	0	0.000	0.000
20	0.02	0.16	0.998	12.42	40	6.600	0.531	50	8.250	0.664	50	8.250	0.664
40	0.04	0.32	0.997	12.40	80	13.200	1.064	86	14.190	1.144	105	17.325	1.397
60	0.06	0.48	0.995	12.38	120	19.800	1.599	121	19.965	1.613	145	23.925	1.932
80	0.08	0.64	0.994	12.36	150	24.750	2.002	155	25.575	2.069	225	37.125	3.003
100	0.10	0.80	0.992	12.34	175	28.875	2.340	185	30.525	2.473	270	44.550	3.610
120	0.12	0.96	0.990	12.32	189	31.185	2.531	210	34.650	2.812	330	54.450	4.419
140	0.14	1.13	0.989	12.30	191	31.515	2.562	224	36.960	3.005	345	56.925	4.628
160	0.16	1.29	0.987	12.28	198	32.670	2.660	235	38.775	3.157	355	58.575	4.770
180	0.18	1.45	0.986	12.26	204	33.660	2.745	241	39.765	3.243	363	59.895	4.885
200	0.20	1.61	0.984	12.24	209	34.485	2.817	248	40.920	3.343	368	60.720	4.960
220	0.22	1.77	0.982	12.22	214	35.310	2.889	255	42.075	3.443	372	61.380	5.022
240	0.24	1.93	0.981	12.20	216	35.640	2.921	261	43.065	3.530	375	61.875	5.071
260	0.26	2.09	0.979	12.18	218	35.970	2.953	265	43.725	3.590	379	62.535	5.134
280	0.28	2.25	0.977	12.16	220	36.300	2.985	270	44.550	3.663	382	63.030	5.183
300	0.30	2.41	0.976	12.14	221	36.465	3.003	275	45.375	3.737	384	63.360	5.219
320	0.32	2.57	0.974	12.12	234	38.610	3.185	278	45.870	3.784	385	63.525	5.241
340	0.34	2.73	0.973	12.10	254	41.910	3.465	281	46.365	3.831	389	64.185	5.304
360	0.36	2.89	0.971	12.08	257	42.405	3.510	285	47.025	3.892	391	64.515	5.340
380	0.38	3.05	0.969	12.06	265	43.725	3.625	287	47.355	3.926	393	64.845	5.376
400	0.40	3.22	0.968	12.04	259	42.735	3.549	290	47.850	3.974	420	69.300	5.755
420	0.42	3.38	0.966	12.02				294	48.510	4.035	394	65.010	5.408
440	0.44	3.54	0.965	12.00				297	49.005	4.083	393	64.845	5.403
460	0.46	3.70	0.963	11.98				299	49.335	4.118			
480	0.48	3.86	0.961	11.96				302	49.830	4.166			
500	0.50	4.02	0.960	11.94				304	50.160	4.201			
520	0.52	4.18	0.958	11.92				306	50.490	4.235			
540	0.54	4.34	0.957	11.90				308	50.820	4.270			
560	0.56	4.50	0.955	11.88				310	51.150	4.305			
580	0.58	4.66	0.953	11.86				315	51.975	4.382			
600	0.60	4.82	0.952	11.84				324	53.460	4.515			
620	0.62	4.98	0.950	11.82				318	52.470	4.439			
640	0.64	5.14	0.949	11.80				319	52.635	4.460			
660	0.66	5.31	0.947	11.78				319	52.635	4.468			
680	0.68	5.47	0.945	11.76				317	52.305	4.447			



LABORATORIUM MEKANIKA TANAH

FAKULTAS TEKNIK SIPIL DAN PERENCANAAN

UNIVERSITAS ISLAM INDONESIA

Jl. Kaliurang KM 14,5 Telp. (0274) 895042, 895707, fax 895330 Yogyakarta 55584

TRIAXIAL TEST

Project : Final Assignment
 Location : Cepagan, Pekalongan, Jawa Tengah
 Description of soil : Silty Clay 4.5% 3hari(2)

Depth : 1,20 meter
 Date : September 1, 2006
 Tested by : Purwadi

Grafik Tegangan-Regangan

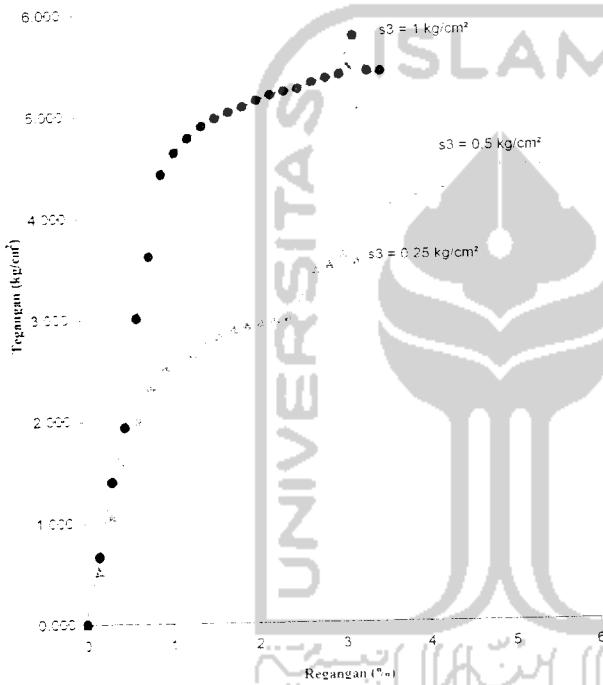

Kadar air

No. Pengujian	1	2
Berat container, gr	0	0
Berat cont. + tanah basah, gr	0	0
Berat cont. + tanah kering, gr	0	0
Kadar air	0.00	0.00
Kadar air rata-rata	27.71	

No. Pengujian	1	2	3
Diameter benda uji, cm	3.98	3.83	3.79
Tinggi benda uji, cm	7.60	7.70	7.64
Luas mula-mula, cm ²	12.44	11.52	11.28
Volume benda uji, cm ³	94.55	88.71	86.19
Berat benda uji, gr	146.12	146.28	146.58
Berat vol. tanah, gr/cm ³	1.545	1.649	1.701
Kalibrasi	0.165		

Brt vol. basah, gr/cm ³	1.545	1.649	1.701
Brt vol. kering, gr/cm ³	1.210	1.291	1.332

σ_3	0.25	0.5	1.0
$\sigma_1 - P/A$	3.625	4.515	5.755
$\sigma_1 - \sigma_3$	3.875	5.015	6.755
$(\sigma_1 + \sigma_3)/2$	2.065	2.757	3.878
$(\sigma_1 - \sigma_3)/2$	1.815	2.257	2.878

Sudut gesek dalam (°)	34.30
Nilai kohesi (kg/cm ²)	0.81

Diagram Mohr

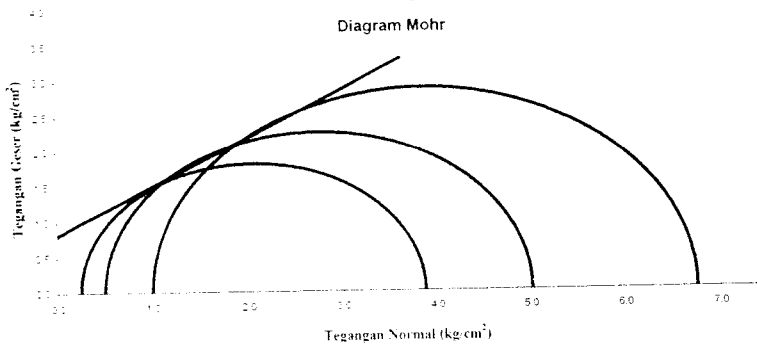

Diperiksa Oleh :

Dr. Ir. Edy Purwanto, CES, DEA



LABORATORIUM MEKANIKA TANAH
FAKULTAS TEKNIK SIPIL DAN PERENCANAAN
UNIVERSITAS ISLAM INDONESIA

Jl. Kaliurang KM 14,5 Telp. (0274) 895042, 895707, fax 895330 Yogyakarta 55584

TRIAxIAL TEST

Project : Tugas Akhir
Location : Cepagan, Pekalongan, Jawa Tengah
Description of soil : Campuran Kapur Karbid 4,5% (Pemeraman 7 hari)

Depth : 1,20 meter
Date : September 7, 2006
Tested by : Purwadi

Diameter benda uji	3,98 cm
Tinggi benda uji	7,50 cm
Luas mula-mula	12,44 cm ²
Volume benda uji	95,31 cm ³
Berat benda uji	gram
Berat volume tanah	1,603 gr cm ³
Kalibrasi	0,165

Kadar air 27,71

Pembacaan beban

Regangan		Tekanan sel = 0,25 kg/cm ²					Tekanan sel = 0,5 kg/cm ²			Tekanan sel = 1,00 kg/cm ²			
Pemb. dial	L = a · 10 ⁻³	Luas koreksi	A=luas	Pemb. dial	Beban P	= P/A	Pemb. dial	Beban P	= P/A	Pemb. dial	Beban P	= P/A	
(mm)	(cm)	(cm ²)	(cm ²)	(mm)	(kg)	(kg/cm ²)	(mm)	(kg)	(kg/cm ²)	(mm)	(kg)	(kg/cm ²)	
1	2	3	4	5	6	7	8	9	10	11	12	13	14
0	0	0,00	0,998	12,44	0	0,000	0,000	0	0,000	0,000	0	0,000	0,000
20	0,02	0,16	0,998	12,42	120	19,800	1,594	130	21,450	1,727	142	23,430	1,886
40	0,04	0,32	0,997	12,40	143	23,595	1,903	158	26,070	2,102	151	24,915	2,009
60	0,06	0,48	0,995	12,38	150	24,750	1,999	170	28,050	2,266	173	28,875	2,332
80	0,08	0,64	0,994	12,36	152	25,050	2,029	180	29,700	2,403	195	32,175	2,603
100	0,10	0,80	0,992	12,34	157	25,905	2,099	189	31,185	2,527	210	34,650	2,808
120	0,12	0,96	0,990	12,32	161	26,565	2,156	195	32,175	2,611	223	36,795	2,986
140	0,14	1,12	0,989	12,30	162	26,730	2,173	203	33,495	2,723	235	38,775	3,152
160	0,16	1,28	0,987	12,28	163	26,895	2,190	205	33,825	2,754	241	39,765	3,238
180	0,18	1,44	0,986	12,26	164	27,060	2,207	209	34,485	2,813	248	40,920	3,337
200	0,20	1,60	0,984	12,24	170	28,050	2,291	210	34,650	2,831	255	42,075	3,437
220	0,22	1,76	0,982	12,22	174	28,710	2,349	213	35,145	2,876	264	43,560	3,564
240	0,24	1,92	0,981	12,20	180	29,700	2,434	213	35,145	2,880	270	44,550	3,651
260	0,26	2,08	0,979	12,18	178	29,370	2,411	214	35,310	2,899	275	45,375	3,725
280	0,28	2,24	0,977	12,16				215	35,475	2,917	279	46,035	3,785
300	0,30	2,40	0,976	12,14				216	35,640	2,936	284	46,860	3,860
320	0,32	2,56	0,974	12,12				218	35,970	2,968	286	47,190	3,893
340	0,34	2,72	0,973	12,10				219	36,135	2,986	290	47,850	3,954
360	0,36	2,88	0,971	12,08				220	36,300	3,005	295	48,675	4,029
380	0,38	3,04	0,969	12,06				220	36,300	3,010	296	48,840	4,049
400	0,40	3,20	0,968	12,04				221	36,465	3,028	298	49,170	4,084
420	0,42	3,36	0,966	12,02				222	36,630	3,047	301	49,665	4,132
440	0,44	3,52	0,965	12,00				225	37,125	3,093	306	50,490	4,207
460	0,46	3,70	0,963	11,98				230	37,950	3,168	310	51,150	4,269
480	0,48	3,86	0,961	11,96				230	37,950	3,173	312	51,480	4,304
500	0,50	4,02	0,960	11,94				225	37,125	3,100	315	51,975	4,353
520	0,52	4,18	0,958	11,92							317	52,305	4,388
540	0,54	4,34	0,957	11,90							319	52,635	4,423
560	0,56	4,50	0,955	11,88							321	52,965	4,458
580	0,58	4,66	0,953	11,86							322	53,130	4,479
600	0,60	4,82	0,952	11,84							324	53,460	4,515
620	0,62	4,98	0,950	11,82							324	53,460	4,522
640	0,64	5,14	0,949	11,80							325	53,625	4,544
660	0,66	5,31	0,947	11,78							335	55,275	4,692
680	0,68	5,47	0,945	11,76							337	55,605	4,728
700	0,70	5,63	0,944	11,74							339	55,935	4,764
720	0,72	5,79	0,942	11,72							338	55,770	4,758



LABORATORIUM MEKANIKA TANAH

FAKULTAS TEKNIK SIPIL DAN PERENCANAAN

UNIVERSITAS ISLAM INDONESIA

Jl. Kaliurang KM 14,5 Telp. (0274) 895042, 895707, fax 895330 Yogyakarta 55584

TRIAxIAL TEST

Project : Final Assignment
 Location : Cepagan, Pekalongan, Jawa Tengah
 Description of soil : Silty Clay 4.5% 7 hari (1)

Depth : 1,20 meter
 Date : September 7, 2006
 Tested by : Purwadi

Grafik Tegangan-Regangan

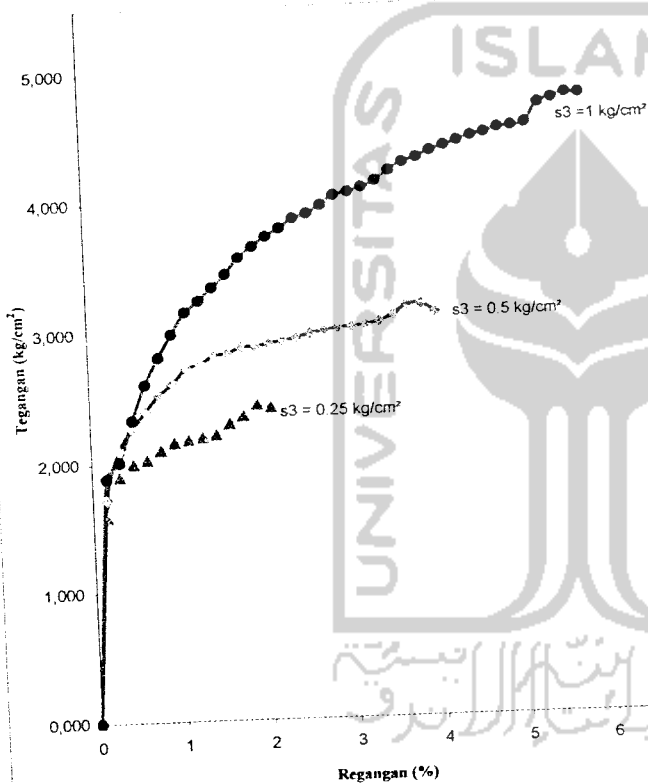

Kadar air

No. Pengujian	1	2
Berat container, gr	0	0
Berat cont. + tanah basah, gr	0	0
Berat cont. + tanah kering, gr	0	0
Kadar air	0,00	0,00
Kadar air rata-rata	27,71	

No. Pengujian	1	2	3
Diameter benda uji, cm	3,98	3,83	3,79
Tinggi benda uji, cm	7,60	7,54	7,42
Luas mula-mula, cm ²	12,44	11,52	11,28
Volume benda uji, cm ³	94,55	86,87	83,71
Berat benda uji, gr	148,02	148,36	149,58
Berat vol tanah, gr/cm ³	1,565	1,708	1,787
Kalibrasi	0,165		

Brt vol. basah, gr/cm ³	1,565	1,708	1,787
Brt vol. kering, gr/cm ³	1,226	1,337	1,399

σ_3	0,25	0,5	1,0
$\sigma_1 = \sigma_3 + P/A$	2,434	3,173	4,764
$(\sigma_1 + \sigma_3)/2$	2,684	3,673	5,764
$(\sigma_1 - \sigma_3)/2$	1,467	2,086	3,382
$(\sigma_1 - \sigma_3)/2$	1,217	1,586	2,382

Sudut gesek dalam (°)	38,24
Nilai kohesi (kg/cm ²)	0,37

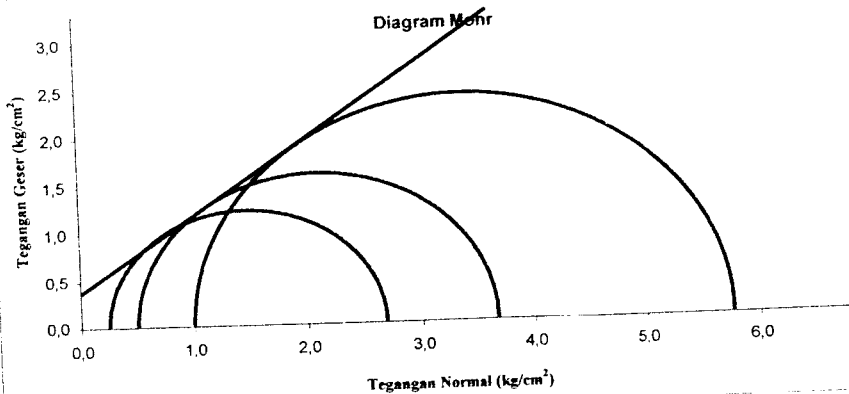

Diperiksa Oleh :

Dr. Ir. Eby Purwanto, CES, DEA



LABORATORIUM MEKANIKA TANAH
FAKULTAS TEKNIK SIPIL DAN PERENCANAAN
UNIVERSITAS ISLAM INDONESIA

Jl. Kaliurang KM 14,5 Telp. (0274) 895042, 895707, fax 895330 Yogyakarta 55584

TRIAXIAL TEST

Project : Tugas Akhir
 Location : Cepagan, Pekalongan, Jawa Tengah
 Description of soil : Campuran Kapur Karbid 4,5% (Pemeraman 7 hari)2

Depth : 1,20 meter
 Date : September 8, 2006
 Tested by : Purwadi

Diameter benda uji	3,98 cm
Tinggi benda uji	7,50 cm
Luas mula-mula	12,44 cm ²
Volume benda uji	93,31 cm ³
Berat benda uji	gram
Berat volume tanah	1,576 gr/cm ³
Kahbrasi	0,165

Kadar air : 27,71

Pembacaan beban

Reaganan		Luas benda uji			Tekanan sel = 0,25 kg/cm ²			Tekanan sel = 0,5 kg/cm ²			Tekanan sel = 1,00 kg/cm ²		
Pemb. dial	L. = a 10 ⁻³	L.L	koreksi luas	A=luas terkoreksi	Pemb. dial	Beban P (kg)	= P/A (kg/cm ²)	Pemb. dial	Beban P (kg)	= P/A (kg/cm ²)	Pemb. dial	Beban P (kg)	= P/A (kg/cm ²)
1	2	3	4	5	6	7	8	9	10	11	12	13	14
0	0	0,00	1,000	12,44	0	0,000	0,000	0	0,000	0,000	0	0,000	0,000
20	0,02	0,76	0,998	12,42	65	10,725	0,863	93	15,345	1,235	105	17,325	1,395
40	0,04	0,52	0,997	12,40	75	12,375	0,998	110	18,150	1,464	155	25,575	2,062
60	0,06	0,48	0,995	12,38	85	14,025	1,133	134	22,110	1,786	200	33,000	2,665
80	0,08	0,64	0,994	12,36	85	14,520	1,175	141	23,265	1,882	258	39,270	3,177
100	0,10	0,80	0,992	12,34	92	15,180	1,230	145	23,925	1,939	260	42,900	3,476
120	0,12	0,96	0,990	12,32	94	15,510	1,259	148	24,420	1,982	280	46,200	3,750
140	0,14	1,12	0,989	12,31	96	15,840	1,288	149	24,585	1,999	291	48,015	3,903
160	0,16	1,28	0,987	12,29	93	16,170	1,317	149	24,585	2,002	300	49,500	4,031
180	0,18	1,44	0,986	12,27	100	16,500	1,346	152	24,915	2,032	305	50,325	4,104
200	0,20	1,60	0,984	12,24	102	16,830	1,375	152	25,080	2,049	313	51,645	4,219
220	0,22	1,77	0,982	12,22	103	16,995	1,391	153	25,245	2,066	318	52,470	4,293
240	0,24	1,93	0,981	12,20	104	17,160	1,406	155	25,575	2,096	323	53,295	4,368
260	0,26	2,09	0,979	12,18	104	17,160	1,409	156	25,740	2,113	328	54,120	4,443
280	0,28	2,25	0,977	12,16	105	17,325	1,425	158	26,070	2,144	328	54,120	4,450
300	0,30	2,41	0,976	12,14	105	17,325	1,427	159	26,235	2,161	329	54,285	4,471
320	0,32	2,57	0,974	12,12	110	18,150	1,497	160	26,400	2,178	331	54,615	4,506
340	0,34	2,73	0,973	12,10	115	18,975	1,563	171	28,215	2,332	331	54,615	4,513
360	0,36	2,89	0,971	12,08	119	19,635	1,625	178	29,370	2,431	338	55,275	4,575
380	0,38	3,05	0,969	12,06	124	20,460	1,696	192	31,680	2,627	338	55,770	4,624
400	0,40	3,22	0,968	12,04	134	22,110	1,836	201	33,165	2,754	340	56,100	4,659
420	0,42	3,38	0,966	12,02	142	23,430	1,949	220	36,300	3,020	342	56,430	4,694
440	0,44	3,54	0,965	12,00	156	25,740	2,145	234	38,610	3,217	343	56,595	4,716
460	0,46	3,70	0,963	11,98	160	26,400	2,203	245	40,425	3,374	343	56,925	4,751
480	0,48	3,86	0,961	11,96	167	27,555	2,304	251	41,445	3,462	347	57,255	4,787
500	0,50	4,02	0,960	11,94	168	27,885	2,335	250	41,250	3,454	352	58,080	4,864
520	0,52	4,18	0,958	11,92	183	29,865	2,505				364	60,060	5,038
540	0,54	4,34	0,957	11,90	170	28,050	2,357				357	58,905	4,950



LABORATORIUM MEKANIKA TANAH

FAKULTAS TEKNIK SIPIL DAN PERENCANAAN

UNIVERSITAS ISLAM INDONESIA

Jl. Kaliurang KM 14,5 Telp. (0274) 895042, 895707, fax 895330 Yogyakarta 55584

TRIAXIAL TEST

Project : Final Assignment
 Location : Cepagan, Pekalongan, Jawa Tengah
 Description of soil : Silty Clay

Depth : 1,20 meter
 Date : September 8, 2006
 Tested by : Purwadi

Grafik Tegangan-Regangan

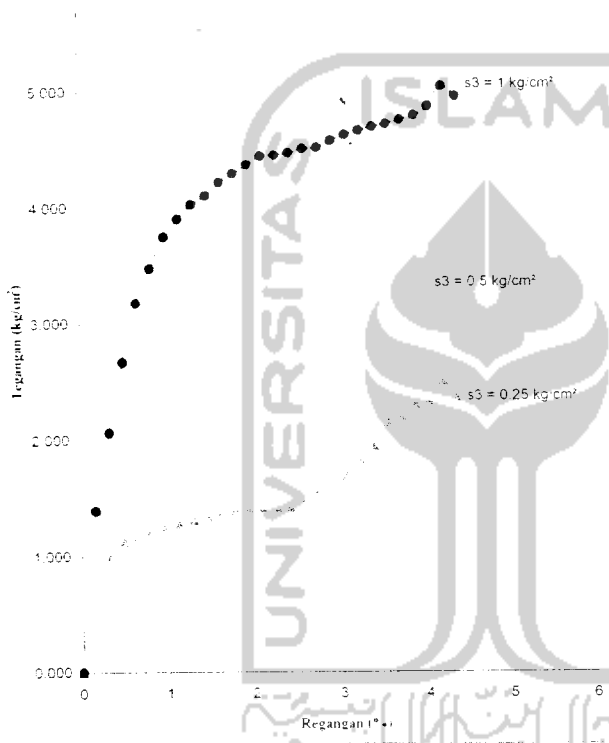

Kadar air

No. Pengujian	1	2
Berat container, gr	0	0
Berat cont. - tanah basah, gr	0	0
Berat cont. - tanah kering, gr	0	0
Kadar air	0.00	0.00
Kadar air rata-rata	27.71	

No. Pengujian	1	2	3
Diameter benda uji, cm	3.98	3.83	3.79
Tinggi benda uji, cm	7.60	7.70	7.64
Luas mula-mula, cm ²	12.44	11.52	11.28
Volume benda uji, cm ³	94.55	88.71	86.19
Berat benda uji, gr	146.52	146.58	147.61
Berat vol. tanah, gr/cm ³	1.550	1.652	1.706
Kalibrasi	0.165		

Brt vol. basah, gr cm ³	1.550	1.652	1.706
Brt vol. kering, gr cm ³	1.213	1.294	1.336

s_3	0.25	0.5	1.0
$\sigma_1 - \sigma_3$ P.A	2.505	3.462	5.033
$\sigma_1 - \sigma_3$ P.S	2.755	3.962	6.033
$(\sigma_1 - \sigma_3) / 2$	1.503	2.231	3.519
$(\sigma_1 + \sigma_3) / 2$	1.253	1.731	2.519

Sudut gesek dalam ($^\circ$)	38.49
Nilai kohesi (kg cm ²)	0.40

Diagram Mohr

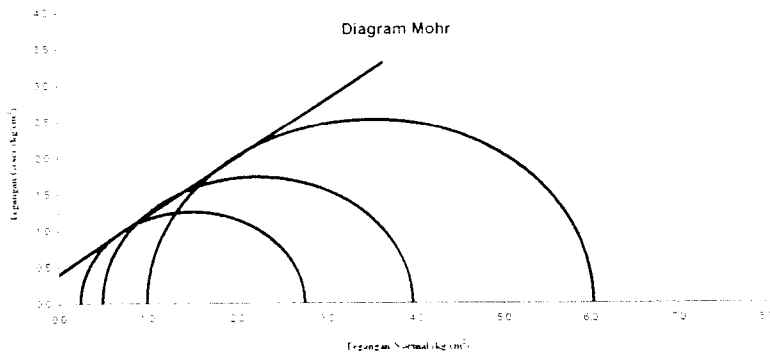

Diperiksa Oleh

 Dr. Ir. Eddy Purwanto, CES, DEA



LABORATORIUM MEKANIKA TANAH
FAKULTAS TEKNIK SIPIL DAN PERENCANAAN
UNIVERSITAS ISLAM INDONESIA

Jl. Kaliurang KM 14,5 Telp. (0274) 895042, 895707, fax 895330 Yogyakarta 55584

TRIAXIAL TEST

Project : Tugas Akhir

Location : Cepagan, Pekalongan, Jawa Tengah

Description of soil : Campuran Kapur Karbid 4,5% (Pemeraman 14 hari)

Depth : 1,20 meter

Date : September 18, 2006

Tested by : Purwadi

Diameter benda uji	3.98 cm
Tinggi benda uji	7.50 cm
Luas mula-mula	12.44 cm ²
Volume benda uji	93.31 cm ³
Berat benda uji	gram
Berat volume tanah	1.610 gr/cm ³
Kalibrasi	0.165

Kadar air	27.71
-----------	-------

Pembacaan beban

Regangan			Luas benda uji			Tekanan sel = 0.25 kg/cm ²			Tekanan sel = 0.5 kg/cm ²			Tekanan sel = 1.00 kg/cm ²		
Pemb dial	$L = a \cdot 10^{-3}$	L.L. (%)	koreksi luas	A=luas terkoreksi	Pemb dial	Beban P (kg)	= P/A (kg/cm ²)	Pemb dial	Beban P (kg)	= P/A (kg/cm ²)	Pemb dial	Beban P (kg)	= P/A (kg/cm ²)	
1	2	3	4	5	6	7	8	9	10	11	12	13	14	
0	0	0.00	1.000	12.44	0	0.000	0.000	0	0.000	0.000	0	0.000	0.000	
20	0.02	0.16	0.998	12.42	78	12.870	1.036	100	16.500	1.328	130	21.450	1.727	
40	0.04	0.32	0.997	12.40	125	20.625	1.663	155	25.575	2.062	195	32.175	2.595	
60	0.06	0.48	0.998	12.38	140	23.100	1.866	185	30.525	2.465	245	40.425	3.265	
80	0.08	0.64	0.994	12.36	156	25.740	2.082	205	33.825	2.736	270	44.550	3.604	
100	0.10	0.80	0.992	12.32	170	28.050	2.273	215	35.475	2.875	284	46.860	3.797	
120	0.12	0.96	0.990	12.32	185	30.525	2.477	250	41.250	3.348	291	48.015	3.897	
140	0.14	1.13	0.989	12.30	195	32.175	2.616	280	46.200	3.756	293	48.345	3.950	
160	0.16	1.29	0.987	12.28	211	34.815	2.835	296	48.840	3.977	295	48.675	3.963	
180	0.18	1.45	0.986	12.26	225	37.125	3.028	301	49.665	4.051	310	51.150	4.172	
200	0.20	1.61	0.984	12.24	256	38.940	3.181	308	50.820	4.152	325	53.625	4.381	
220	0.22	1.77	0.982	12.22	248	40.920	3.348	319	52.635	4.307	330	54.450	4.455	
240	0.24	1.93	0.981	12.20	261	43.065	3.530	324	53.460	4.382	349	57.585	4.720	
260	0.26	2.09	0.979	12.18	274	45.210	3.712	328	54.120	4.443	365	60.225	4.944	
280	0.28	2.25	0.977	12.16	275	45.375	3.731	342	56.430	4.640	371	61.215	5.034	
300	0.30	2.41	0.976	12.14	285	47.025	3.873	351	57.915	4.770	390	64.350	5.300	
320	0.32	2.57	0.974	12.12	298	49.170	4.057	365	60.225	4.969	415	68.475	5.649	
340	0.34	2.73	0.973	12.10	315	51.975	4.295	360	59.400	4.909	419	69.135	5.713	
360	0.36	2.89	0.971	12.08	305	50.325	4.166	358	59.070	4.889	428	70.620	5.846	
380	0.38	3.05	0.969	12.06				356	58.740	4.870	438	72.270	5.992	
400	0.40	3.22	0.968	12.04							449	74.085	6.153	
420	0.42	3.38	0.966	12.02							469	77.385	6.437	
440	0.44	3.54	0.965	12.00							467	77.055	6.421	



LABORATORIUM MEKANIKA TANAH

FAKULTAS TEKNIK SIPIL DAN PERENCANAAN

UNIVERSITAS ISLAM INDONESIA

Jl. Kaliurang KM 14,5 Telp. (0274) 895042, 895707, fax 895330 Yogyakarta 55584

TRIAxIAL TEST

Project : Final Assignment
 Location : Cepagan, Pekalongan, Jawa Tengah
 Description of soil : Silty Clay +karbid 4,5% 14hr(1)

Depth : 1,20 meter
 Date : September 18, 2006
 Tested by : Purwadi

Grafik Tegangan-Regangan

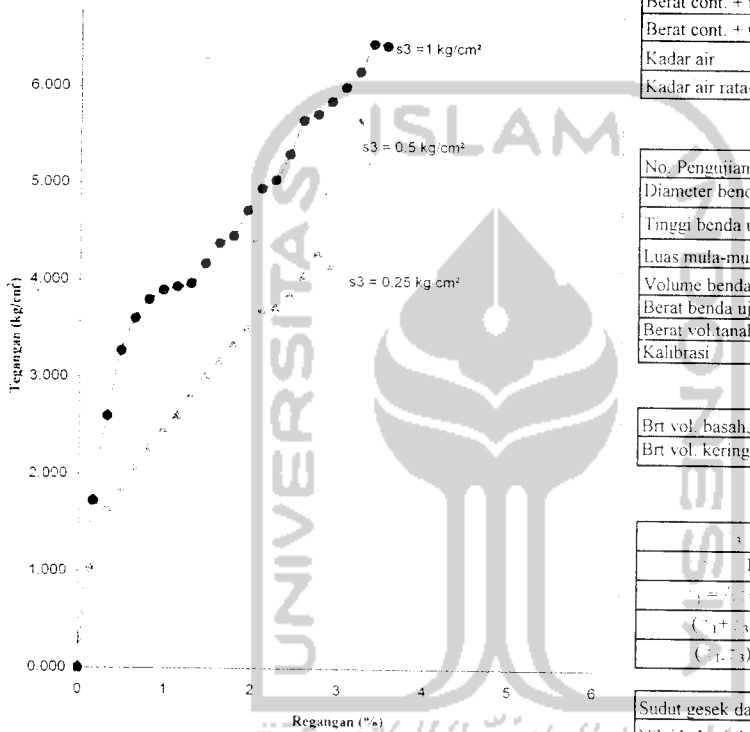

Kadar air

No. Pengujian	1	2
Berat container, gr	0	0
Berat cont. + tanah basah, gr	0	0
Berat cont. + tanah kering, gr	0	0
Kadar air	0.00	0.00
Kadar air rata-rata	27.71	

No. Pengujian	1	2	3
Diameter benda uji, cm	3.98	3.83	3.79
Tinggi benda uji, cm	7.60	7.54	7.42
Luas muka-mula, cm ²	12.44	11.52	11.28
Volume benda uji, cm ³	94.55	86.87	83.71
Berat benda uji, gr	148.33	149.13	150.19
Berat vol.tanah, gr/cm ³	1.569	1.717	1.794
Kalibrasi	0.163		

Brt vol. basah, gr/cm ³	1.569	1.717	1.794
Brt vol. kering, gr/cm ³	1.228	1.344	1.403

σ_3	0.25	0.5	1.0
σ_1	4.295	4.969	6.437
$\sigma_1 - \sigma_3$	4.545	5.469	7.437
$(\sigma_1 + \sigma_3)/2$	2.398	2.984	4.219
$(\sigma_1 - \sigma_3)/2$	2.148	2.484	3.219

Sudut gesek dalam (°)	36.00	
Nilai kohesi (kg/cm ²)	0.93	

Diagram Mohr

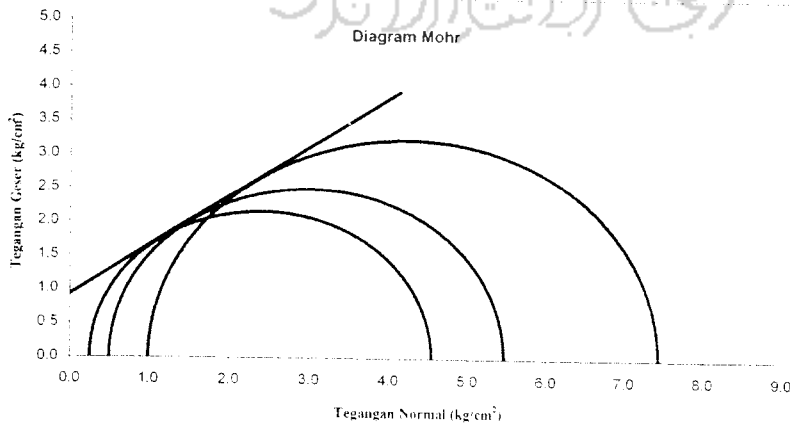

Diperiksa Oleh :

Dr. Ir. Edi Purwanto, CES, DEA



LABORATORIUM MEKANIKA TANAH
FAKULTAS TEKNIK SIPIL DAN PERENCANAAN
UNIVERSITAS ISLAM INDONESIA

Jl. Kaliurang KM 14,5 Telp. (0274) 895042, 895707, fax 895330 Yogyakarta 55584

TRIAXIAL TEST

Project : Tugas Akhir
Location : Cepagan, Pekalongan, Jawa Tengah
Description of soil : Campuran Kapur Karbid 4,5% (Pemeraman 14 hari)2

Depth : 1,20 meter
Date : September 8, 2006
Tested by : Purwadi

Diameter benda uji	3.98 cm
Tinggi benda uji	7.50 cm
Luas mula-mula	12.44 cm ²
Volume benda uji	93.31 cm ³
Berat benda uji	gram
Berat volume tanah	1.625 gr/cm ³
Kalibrasi	0.165

Kadar air	27.71
-----------	-------

Pembacaan beban

Regangan		Luas benda uji			Tekanan sel = 0.25 kg cm ²			Tekanan sel = 0.5 kg cm ²			Tekanan sel = 1.00 kg cm ²		
Pemb. dial	L = a/10 ⁻³	ε = ΔL/L	koreksi luas	A=luas terkoreksi	Pemb. dial	Beban P (kg)	σ = P/A (kg cm ⁻²)	Pemb. dial	Beban P (kg)	σ = P/A (kg cm ⁻²)	Pemb. dial	Beban P (kg)	σ = P/A (kg cm ⁻²)
(a)	(cm)	(%)	1-ε	Ao[1-ε]									
0	0	0.00	1.000	12.44	0	0.000	0.000	0	0.000	0.000	12	0	0.000
20	0.02	0.16	0.998	12.42	95	15.675	1.262	110	18.150	1.461	120	19.800	1.594
40	0.04	0.32	0.997	12.40	110	18.150	1.464	180	29.700	2.395	210	34.650	2.794
60	0.06	0.48	0.995	12.38	175	28.875	2.332	251	41.415	3.345	275	45.375	3.665
80	0.08	0.64	0.994	12.36	230	37.950	3.070	281	46.365	3.751	320	52.800	4.271
100	0.10	0.80	0.992	12.34	240	39.600	3.209	293	48.345	3.917	360	59.400	4.813
120	0.12	0.96	0.990	12.32	268	44.220	3.589	310	51.150	4.151	395	65.175	5.290
140	0.14	1.12	0.988	12.30	281	46.365	3.769	335	55.275	4.494	425	70.125	5.701
160	0.16	1.28	0.987	12.28	295	48.675	3.965	342	56.430	4.595	445	75.075	5.982
180	0.18	1.44	0.986	12.26	308	50.820	4.145	347	56.925	4.643	455	75.075	6.123
200	0.20	1.60	0.984	12.24	315	51.975	4.246	351	57.915	4.731	457	75.405	6.160
220	0.22	1.76	0.982	12.22	320	52.800	4.320	359	59.235	4.847	458	75.570	6.184
240	0.24	1.92	0.981	12.20	324	53.460	4.382	371	61.215	5.017	459	75.735	6.207
260	0.26	2.09	0.979	12.18	325	53.625	4.402	378	62.370	5.120	472	77.880	6.394
280	0.28	2.25	0.977	12.16	324	53.460	4.396	390	64.350	5.291	487	80.355	6.608
300	0.30	2.41	0.976	12.14				387	63.855	5.259	479	79.035	6.510



LABORATORIUM MEKANIKA TANAH
FAKULTAS TEKNIK SIPIL DAN PERENCANAAN
UNIVERSITAS ISLAM INDONESIA

Jl. Kaliurang KM 14,5 Telp. (0274) 895042, 895707, fax 895330 Yogyakarta 55584

TRIAXIAL TEST

Project : Final Assignment
 Location : Cepagan, Pekalongan, Jawa Tengah
 Description of soil : Silty Clay + Karbid 4.5 % 14hr(2)

Depth : 1,20 meter
 Date : September 8, 2006
 Tested by : Purwadi

Grafik Tegangan-Regangan

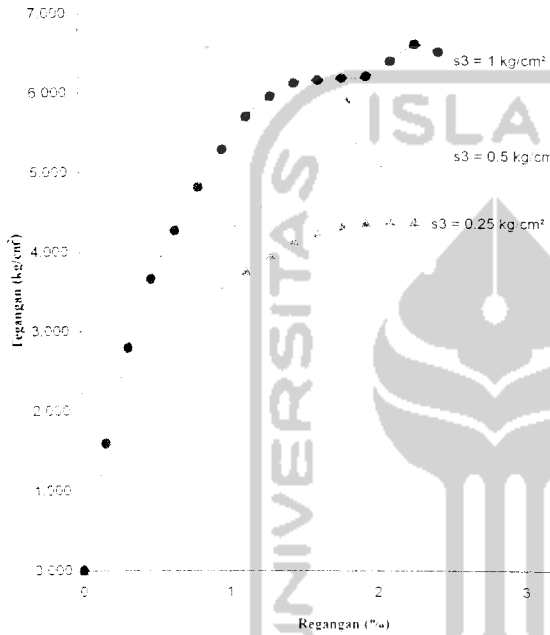

Kadar air

No. Pengujian	1	2
Berat container, gr	0	0
Berat cont. + tanah basah, gr	0	0
Berat cont. + tanah kering, gr	0	0
Kadar air	0.00	0.00
Kadar air rata-rata	27.71	

No. Pengujian	1	2	3
Diameter benda uji, cm	3.98	3.83	3.79
Tinggi benda uji, cm	7.60	7.70	7.64
Luas mula-mula, cm ²	12.44	11.52	11.28
Volume benda uji, cm ³	94.53	88.71	86.19
Berat benda uji, gr	149.95	150.74	151.58
Berat vol tanah, gr/cm ³	1.586	1.699	1.759
Kalibrasi	0.165		

Brt vol. basah, gr/cm ³	1.586	1.699	1.759
Brt Vol. kering, gr/cm ³	1.242	1.331	1.377

	0.25	0.5	1.0
$\sigma_1 - \sigma_3$	4.402	3.291	6.608
$(\sigma_1 + \sigma_3)/2$	4.652	3.791	7.608
$(\sigma_1 - \sigma_3)/2$	2.451	3.146	4.304
$(\sigma_1 + \sigma_3)/2$	2.201	2.646	3.304

Sudut gesek dalam (°)	36.10
Nilai kohesi (kg/cm ²)	0.94

Diagram Mohr

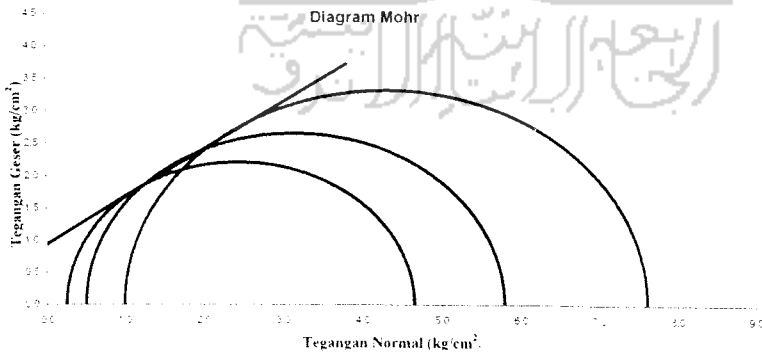

Diperiksa Oleh :

Dr. Ir. Edy Purwanto, CES, DEA

N 18
h + Kart



LABORATORIUM MEKANIKA TANAH

FAKULTAS TEKNIK SIPIL DAN PERENCANAAN

UNIVERSITAS ISLAM INDONESIA

Jl. Kaliurang KM 14,5 Telp. (0274) 895042, 895707, fax 895330 Yogyakarta 55584

TRIAXIAL TEST

Project : Final Assignment
 Location : Cepagan, Pekalongan, Jawa Tengah
 Description of soil : Silty Clay 6% 3hari(1)

Depth : 1,20 meter
 Date : September 1, 2006
 Tested by : Purwadi

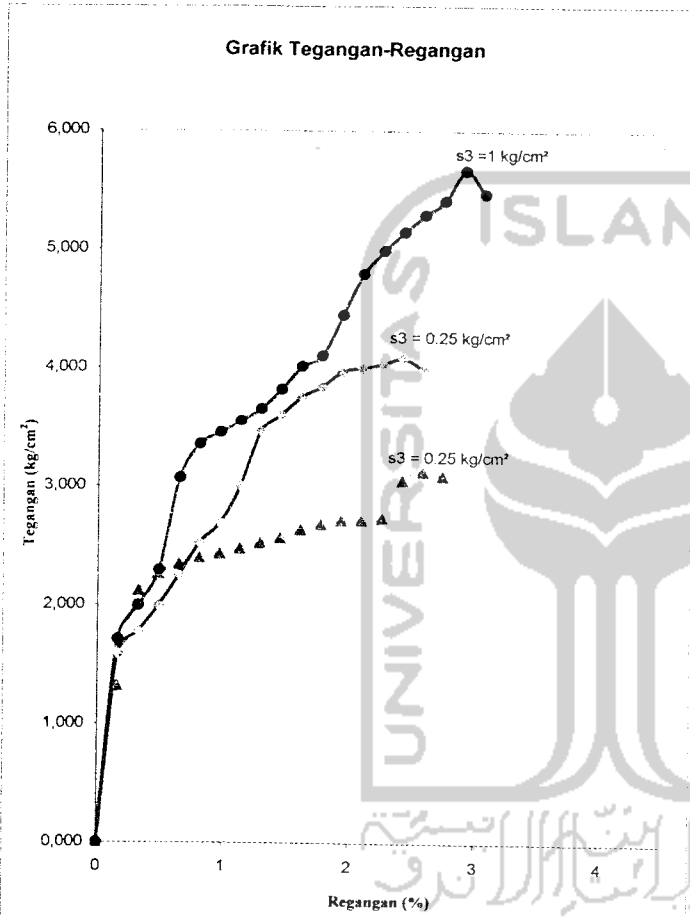

Kadar air

No. Pengujian	1	2
Berat container, gr	0	0
Berat cont. + tanah basah, gr	0	0
Berat cont. + tanah kering, gr	0	0
Kadar air	0,00	0,00
Kadar air rata-rata	27,71	

No. Pengujian	1	2	3
Diameter benda uji, cm	3,98	3,83	3,79
Tinggi benda uji, cm	7,60	7,70	7,64
Luas mula-mula, cm ²	12,44	11,52	11,28
Volume benda uji, cm ³	94,55	88,71	86,19
Berat benda uji, gr	146,02	146,32	147,21
Berat vol. tanah, gr/cm ³	1,544	1,649	1,708
Kalibrasi	0,165		

Brt vol. basah, gr/cm ³	1,544	1,649	1,708
Brt vol. kering, gr/cm ³	1,209	1,292	1,337

σ_3	0,25	0,5	1,0
$\sigma_1 = \sigma_3 + P/A$	3,131	4,091	5,668
$\sigma_1 = \sigma_3 + \sigma_3$	3,381	4,591	6,668
$(\sigma_1 + \sigma_3)/2$	1,815	2,545	3,834
$(\sigma_1 - \sigma_3)/2$	1,565	2,045	2,834

Sudut gesek dalam (°)	37,57
Nilai kohesi (kg/cm ²)	0,59

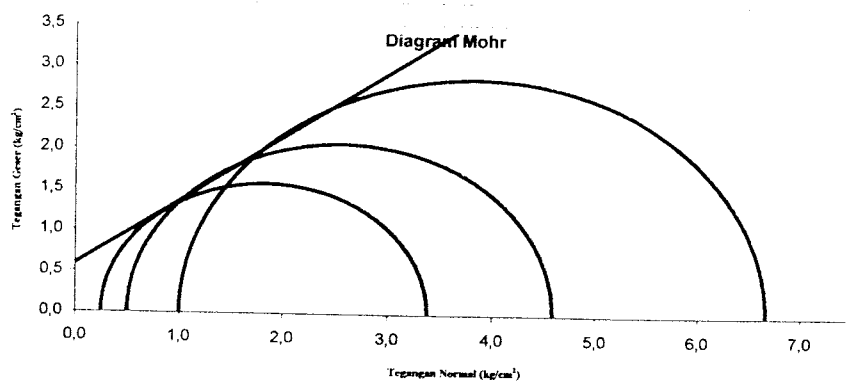

Diperiksa Oleh:

Dr. Ir. Egi Purwanto, CES, DEA



LABORATORIUM MEKANIKA TANAH

FAKULTAS TEKNIK SIPIL DAN PERENCANAAN

UNIVERSITAS ISLAM INDONESIA

Jl. Kaliurang KM 14,5 Telp. (0274) 895042, 895707, fax 895330 Yogyakarta 55584

TRIAXIAL TEST

Project : Final Assignment
 Location : Cepangan, Pekalongan, Jawa Tengah
 Description of soil : Silty Clay 6% 3hari(2)

Depth : 1,20 meter
 Date : September 1, 2006
 Tested by : Purwadi

Grafik Tegangan-Regangan

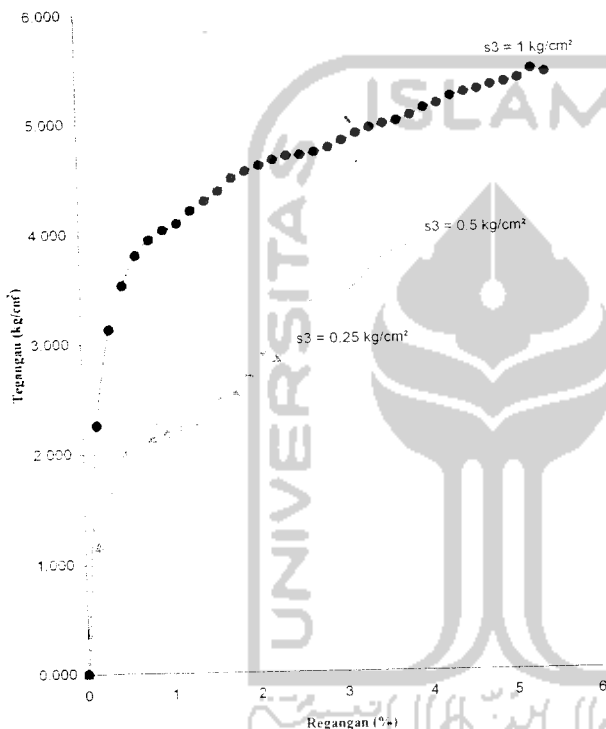

Kadar air

No. Pengujian	1	2
Berat container, gr	0	0
Berat cont. + tanah basah, gr	0	0
Berat cont. + tanah kering, gr	0	0
Kadar air	0.00	0.00
Kadar air rata-rata	27.71	

No. Pengujian	1	2	3
Diameter benda uji, cm	3.98	3.83	3.79
Tinggi benda uji, cm	7.60	7.70	7.64
Luas mula-mula, cm ²	12.44	11.52	11.28
Volume benda uji, cm ³	94.55	88.71	86.19
Berat benda uji, gr	146.12	146.28	146.58
Berat vol tanah, gr/cm ³	1.545	1.649	1.701
Kalibrasi	0.165		

Brt vol. basah, gr cm ³	1.545	1.649	1.701
Brt vol. kering, gr cm ³	1.210	1.291	1.332

σ_3	0.25	0.5	1.0
$\sigma_1 - P/A$	2.912	3.863	5.434
$\sigma_1 - \sigma_3$	3.162	4.363	6.434
$(\sigma_1 + \sigma_3)/2$	1.706	2.431	3.717
$(\sigma_1 - \sigma_3)/2$	1.456	1.931	2.717

Sudut gesek dalam (°)	37.91
Nilai kohesi (kg/cm ²)	0.55

Diagram Mohr

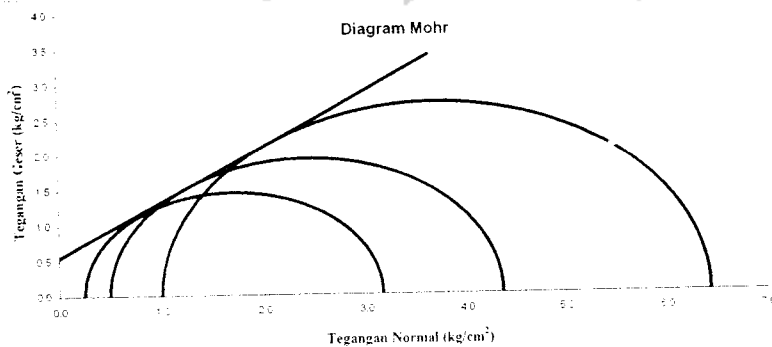

Diperiksa Oleh :

Dr. Ir. Eddy Purwanto, CES, DEA



LABORATORIUM MEKANIKA TANAH

FAKULTAS TEKNIK SIPIL DAN PERENCANAAN

UNIVERSITAS ISLAM INDONESIA

Jl. Kaliurang KM 14,5 Telp. (0274) 895042, 895707, fax 895330 Yogyakarta 55584

TRIAXIAL TEST

Project : Final Assignment
 Location : Cepagan, Pekalongan, Jawa Tengah
 Description of soil : Silty Clay + Karbid 6% 7Hr (1)

Depth : 1,20 meter
 Date : September 1, 2006
 Tested by : Purwadi

Kadar air

No. Pengujian	1	2
Berat container, gr	0	0
Berat cont. + tanah basah, gr	0	0
Berat cont. + tanah kering, gr	0	0
Kadar air	0,00	0,00
Kadar air rata-rata	27,71	

Grafik Tegangan-Regangan

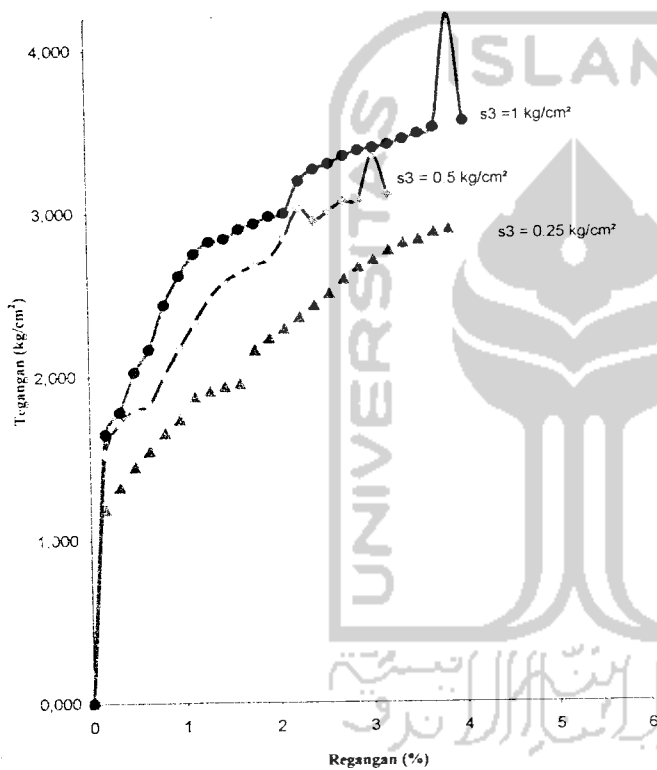

No. Pengujian	1	2	3
Diameter benda uji, cm	3,98	3,83	3,79
Tinggi benda uji, cm	7,60	7,54	7,42
Luas mula-mula, cm ²	12,44	11,52	11,28
Volume benda uji, cm ³	94,55	86,87	83,71
Berat benda uji, gr	146,31	146,52	146,85
Berat vol. tanah, gr/cm ³	1,547	1,687	1,754
Kalibrasi	0,165		

Brt vol. basah, gr/cm ³	1,547	1,687	1,754
Brt vol. kering, gr/cm ³	1,212	1,321	1,374

σ_3	0,25	0,5	1,0
$\sigma_1 = P/A$	2,897	3,352	4,207
$\sigma_1 = \sigma_2 + \sigma_3$	3,147	3,852	5,207
$(\sigma_1 + \sigma_3)/2$	1,698	2,176	3,104
$(\sigma_1 - \sigma_3)/2$	1,448	1,676	2,104

Sudut gesek dalam (°)	27,67
Nilai kohesi (kg/cm ²)	0,74

Diagram Mohr

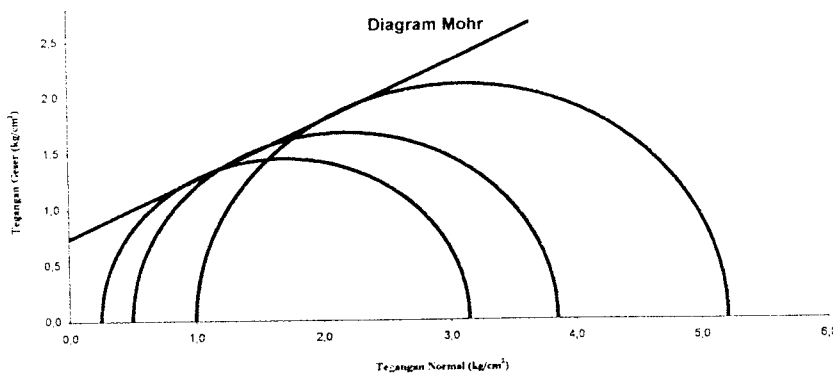

Diperiksa Oleh:

Dr. Ir. Edy Purwanto, CES, DEA



LABORATORIUM MEKANIKA TANAH
FAKULTAS TEKNIK SIPIL DAN PERENCANAAN
UNIVERSITAS ISLAM INDONESIA

Jl. Kaliurang KM 14,5 Telp. (0274) 895042, 895707, fax 895330 Yogyakarta 55584

TRIAxIAL TEST

Project : Tugas Akhir
Location : Cepagan, Pekalongan, Jawa Tengah
Description of soil : Campuran Kapur Karbid 6% (Pemeraman 7 hari)2

Depth : 1,20 meter
Date : September 1, 2006
Tested by : Purwadi

Diameter benda uji	3,98 cm
Tinggi benda uji	7,50 cm
Luas mula-mula	12,44 cm ²
Volume benda uji	93,31 cm ³
Berat benda uji	gram
Berat volume tanah	1,586 gr/cm ³
Kalibrasi	0,165

Kadar air	27,71
-----------	-------

Pembacaan beban

Regangan		Luas benda uji			Tekanan sel = 0,25 kg/cm ²			Tekanan sel = 0,5 kg/cm ²			Tekanan sel = 1,00 kg/cm ²		
Pemb. dial	$\frac{L}{a} \cdot 10^{-3}$	L.L. (%e)	koreksi luas	A=luas terkorksi [Ao(1+e)]	Pemb. dial	Beban P (kg)	= P.A (kg/cm ²)	Pemb. dial	Beban P (kg)	= P.A (kg/cm ²)	Pemb. dial	Beban P (kg)	= P.A (kg/cm ²)
1	2	3	4	5	6	7	8	9	10	11	12	13	14
0	0	0,00	1,000	12,44	0	0,000	0,000	0	0,000	0,000	0	0,000	0,000
20	0,02	0,16	0,998	12,42	98	18,675	1,262	102	16,830	1,355	140	23,100	1,860
40	0,04	0,32	0,997	12,40	98	16,170	1,304	112	18,480	1,490	172	28,380	2,289
60	0,06	0,48	0,995	12,38	102	16,830	1,359	120	21,450	1,532	190	31,350	2,532
80	0,08	0,64	0,994	12,36	110	18,330	1,468	122	23,430	1,895	200	33,000	2,670
100	0,10	0,80	0,992	12,34	116	19,140	1,551	152	24,915	2,019	210	34,650	2,808
120	0,12	0,96	0,990	12,32	130	25,450	1,741	160	26,400	2,145	215	35,475	2,879
140	0,14	1,12	0,989	12,30	135	22,275	1,811	155	30,525	2,482	220	36,300	2,951
160	0,16	1,29	0,987	12,28	140	23,100	1,881	195	32,175	2,620	225	37,125	3,023
180	0,18	1,45	0,986	12,26	155	25,375	2,046	200	33,000	2,691	228	37,620	3,068
200	0,20	1,61	0,984	12,24	175	28,375	2,339	201	33,165	2,709	231	38,115	3,114
220	0,22	1,77	0,982	12,22	180	29,700	2,430	203	33,495	2,741	235	38,775	3,173
240	0,24	1,93	0,981	12,20	184	30,360	2,488	205	33,825	2,772	240	39,600	3,246
260	0,26	2,09	0,979	12,18	188	31,020	2,547	208	34,320	2,817	242	39,930	3,278
280	0,28	2,25	0,977	12,16	189	31,185	2,564	210	34,650	2,849	245	40,425	3,324
300	0,30	2,41	0,976	12,14	190	31,350	2,582	225	35,475	2,922	245	40,425	3,330
320	0,32	2,57	0,974	12,12	191	31,515	2,600	225	35,125	3,063	247	40,755	3,362
340	0,34	2,73	0,973	12,10	195	32,175	2,659	225	40,425	3,341	250	41,250	3,409
360	0,36	2,89	0,971	12,08	198	32,670	2,704	240	39,600	3,278	251	41,415	3,428
380	0,38	3,05	0,969	12,06	204	33,660	2,791				253	41,745	3,461
400	0,40	3,22	0,968	12,04	200	33,000	2,741				254	41,910	3,481
420	0,42	3,38	0,966	12,02							255	42,075	3,500
440	0,44	3,54	0,965	12,00							259	42,735	3,561
460	0,46	3,70	0,963	11,98							260	42,900	3,581
480	0,48	3,86	0,961	11,96							263	43,395	3,628
500	0,50	4,02	0,960	11,94							264	43,560	3,648
520	0,52	4,18	0,958	11,92							265	43,725	3,668
560	0,56	4,50	0,955	11,88							266	43,890	3,694
580	0,58	4,66	0,953	11,86							268	44,220	3,728
600	0,60	4,82	0,952	11,84							270	44,550	3,762
620	0,62	4,98	0,950	11,82							274	45,210	3,825
640	0,64	5,14	0,949	11,80							276	45,540	3,859
660	0,66	5,31	0,947	11,78							279	46,035	3,905
680	0,68	5,47	0,945	11,76							280	46,200	3,928
700	0,70	5,63	0,944	11,74							285	47,025	4,005
720	0,72	5,79	0,942	11,72							287	47,355	4,040
740	0,74	5,95	0,941	11,70							292	48,180	4,118
760	0,76	6,11	0,939	11,68							293	48,345	4,139
780	0,78	6,27	0,937	11,66							294	48,510	4,160
800	0,80	6,43	0,936	11,64							295	48,675	4,181
820	0,82	6,59	0,934	11,62							299	49,335	4,245
840	0,84	6,75	0,932	11,60							295	48,675	4,196



LABORATORIUM MEKANIKA TANAH

FAKULTAS TEKNIK SIPIL DAN PERENCANAAN

UNIVERSITAS ISLAM INDONESIA

Jl. Kaliurang KM 14,5 Telp. (0274) 895042, 895707, fax 895330 Yogyakarta 55584

TRIAXIAL TEST

Project : Final Assignment
 Location : Cepagan, Pekalongan, Jawa Tengah
 Description of soil : Silty Clay+Karbid 6% 7hr(2)

Depth : 1,20 meter
 Date : September 1, 2006
 Tested by : Purwadi

Grafik Tegangan-Regangan

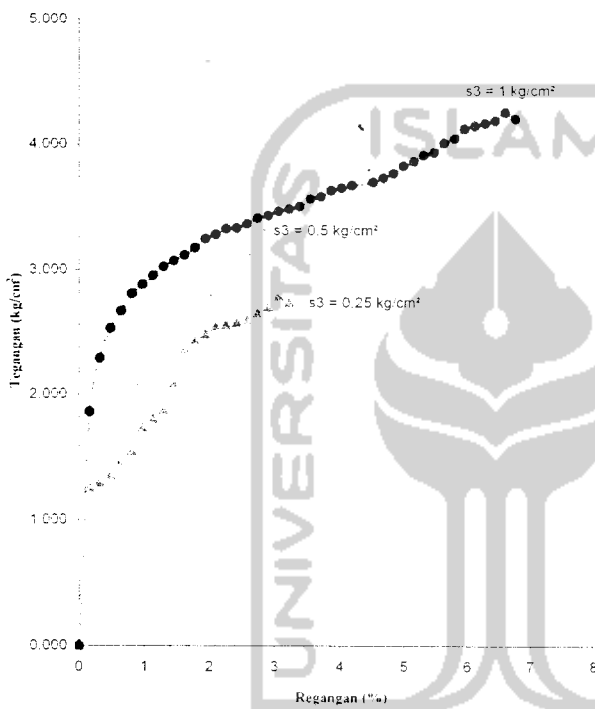

Kadar air

No. Pengujian	1	2
Berat container, gr	0	0
Berat cont. + tanah basah, gr	0	0
Berat cont. + tanah kering, gr	0	0
Kadar air	0.00	0.00
Kadar air rata-rata	27.71	

No. Pengujian	1	2	3
Diameter benda uji, cm	3.98	3.83	3.79
Tinggi benda uji, cm	7.60	7.70	7.64
Luas mula-mula, cm ²	12.44	11.52	11.28
Volume benda uji, cm ³	94.55	88.71	86.19
Berat benda uji, gr	144.25	145.25	145.68
Berat vol.tanah, gr cm ³	1.526	1.657	1.690
Kalibrasi	0.165		

Brt vol. basah, gr cm ³	1.526	1.657	1.690
Brt vol. kering, gr cm ³	1.795	1.282	1.525

σ_3	0.25	0.5	1.0
$\sigma_1 - \sigma_3$ P.A	2.791	3.341	4.160
$\sigma_1 - \sigma_3$	3.041	3.841	5.160
$(\sigma_1 + \sigma_3)/2$	1.645	2.170	3.080
$(\sigma_1 - \sigma_3)/2$	1.395	1.670	2.080

Sudut gesek dalam (°)	28.38
Nilai kohesi (kg cm ²)	0.70

Diagram Mohr

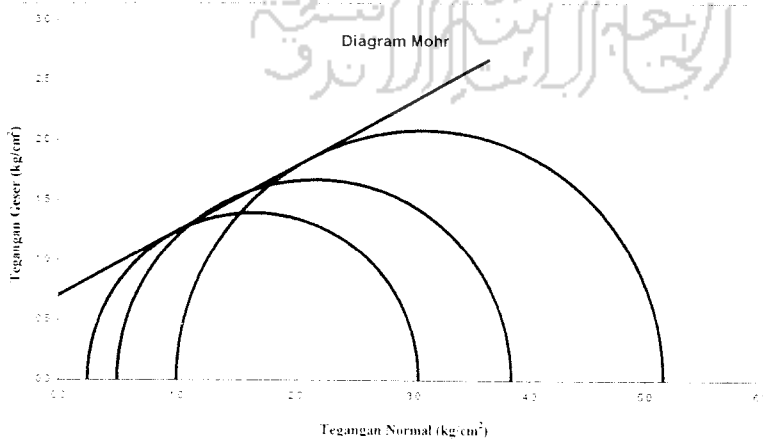

Diperiksa Oleh :

Dr. Ir. Eddy Purwanto, CES, DEA



LABORATORIUM MEKANIKA TANAH
FAKULTAS TEKNIK SIPIL DAN PERENCANAAN
UNIVERSITAS ISLAM INDONESIA

Jl. Kaliurang KM 14,5 Telp. (0274) 895042, 895707, fax 895330 Yogyakarta 55584

TRIAxIAL TEST

Project : Tugas Akhir
 Location : Cepagan, Pekalongan, Jawa Tengah
 Description of soil : Campuran Kapur Karbid 6% (Pemeraman 14 hari)

Depth : 1,20 meter
 Date : September 18, 2006
 Tested by : Purwadi

Diameter benda uji	3,98 cm
Tinggi benda uji	7,50 cm
Luas mula-mula	12,44 cm ²
Volume benda uji	93,31 cm ³
Berat benda uji	gram
Berat volume tanah	1,607 gr/cm ³
Kalibrasi	0,165

Kadar air : 27,7%

Pembacaan beban

Regangan		Luas benda uji			Tekanan sel = 0,25 kg/cm ²			Tekanan sel = 0,5 kg/cm ²			Tekanan sel = 1,00 kg/cm ²		
Pemb. dial	L = a 10 ⁻³	L.L. (%)	koreksi luas	A=luas terkoreksi (A ₀ (1-ε))	Pemb. dial	Beban P (kg)	= P/A (kg/cm ²)	Pemb. dial	Beban P (kg)	= P/A (kg/cm ²)	Pemb. dial	Beban P (kg)	= P/A (kg/cm ²)
1	2	3	4	5	6	7	8	9	10	11	12	13	14
0	0	0,00	1,000	12,44	0	0,000	0,000	0	0,000	0,000	0	0,000	0,000
20	0,02	0,16	0,998	12,42	75	12,375	0,996	96	15,840	1,275	130	21,450	1,727
40	0,04	0,32	0,997	12,40	110	18,150	1,464	154	25,410	2,049	185	30,525	2,461
60	0,06	0,48	0,995	12,38	141	25,265	2,039	193	31,845	2,572	225	37,125	2,999
80	0,08	0,64	0,992	12,36	170	28,050	2,269	212	34,980	2,830	250	41,250	3,337
100	0,10	0,80	0,992	12,34	200	33,000	2,674	233	39,270	3,182	280	46,200	3,744
120	0,12	0,96	0,990	12,32	228	37,620	3,053	259	42,735	3,468	305	50,325	4,084
140	0,14	1,12	0,989	12,30	255	42,075	3,420	289	47,685	3,877	325	53,625	4,359
160	0,16	1,28	0,987	12,28	270	44,550	3,628	296	48,840	3,977	335	55,275	4,501
180	0,18	1,44	0,986	12,26	270	44,550	3,633	302	49,830	4,064	340	56,100	4,575
200	0,20	1,60	0,984	12,24	279	46,035	3,761	310	51,150	4,179	346	57,090	4,664
220	0,22	1,76	0,982	12,22	281	46,365	3,794	308	50,820	4,158	346	57,090	4,671
240	0,24	1,92	0,981	12,20	280	46,200	3,787	307	50,655	4,152	351	57,915	4,747
260	0,26	2,08	0,979	12,18				298	49,170	4,037	352	58,080	4,768
280	0,28	2,24	0,977	12,16							359	59,235	4,871
300	0,30	2,40	0,976	12,14							375	61,875	5,096
320	0,32	2,56	0,974	12,12							356	58,740	4,846



LABORATORIUM MEKANIKA TANAH

FAKULTAS TEKNIK SIPIL DAN PERENCANAAN

UNIVERSITAS ISLAM INDONESIA

Jl. Kaliurang KM 14,5 Telp. (0274) 895042, 895707, fax 895330 Yogyakarta 55584

TRIAXIAL TEST

Project : Final Assignment
 Location : Cepagan, Pekalongan, Jawa Tengah
 Description of soil : Silty Clay +karbid 6% 14hr(1)

Depth : 1,20 meter
 Date : September 18, 2006
 Tested by : Purwadi

Grafik Tegangan-Regangan

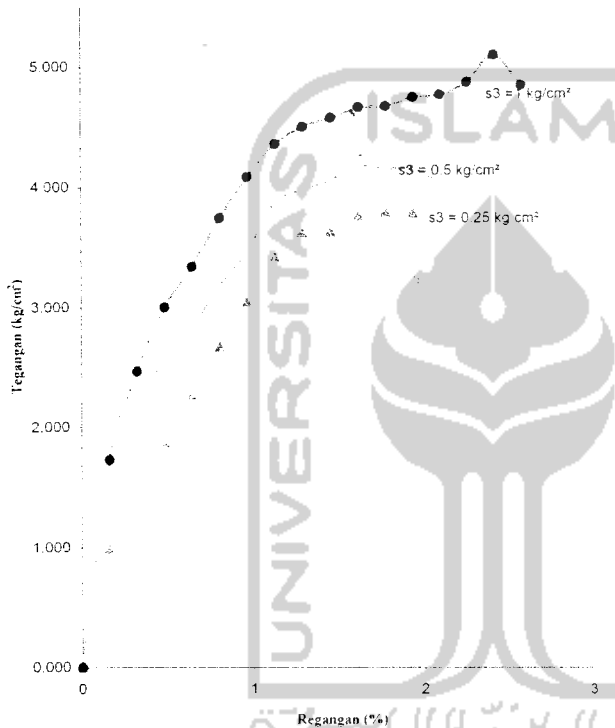

Kadar air

No. Pengujian	1	2
Berat container, gr	0	0
Berat cont. + tanah basah, gr	0	0
Berat cont. + tanah kering, gr	0	0
Kadar air	0.00	0.00
Kadar air rata-rata	27.71	

No. Pengujian	1	2	3
Diameter benda uji, cm	3.98	3.83	3.79
Tinggi benda uji, cm	7.60	7.54	7.42
Luas mula-mula, cm ²	12.44	11.52	11.28
Volume benda uji, cm ³	94.55	86.87	83.71
Berat benda uji, gr	146.56	147.98	149.92
Berat vol tanah, gr/cm ³	1.550	1.704	1.791
Kalibrasi	0.165		

Brt vol. basah, gr/cm ³	1.550	1.704	1.791
Brt vol. kering, gr/cm ³	1.214	1.334	1.402

σ_3	0.25	0.5	1.0
$\sigma_1 - P/A$	3.794	4.179	5.096
$\sigma_1 = \sigma_3 + \sigma_1 - P/A$	4.044	4.679	6.096
$(\sigma_1 + \sigma_3)/2$	2.147	2.589	3.548
$(\sigma_1 - \sigma_3)/2$	1.897	2.089	2.548

Sudut gesek dalam (°)	28.13
Nilai kohesi (kg/cm ²)	0.99

Diagram Mohr

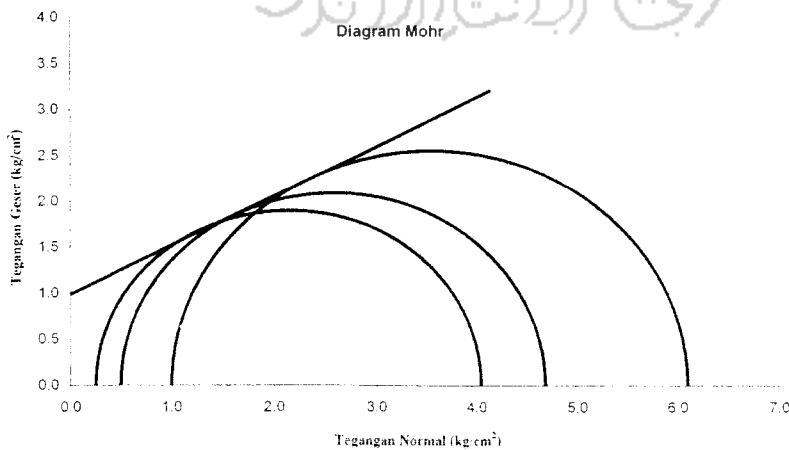

Diperiksa Oleh :

Dr. Ir. Edy Purwanto, CES, DEA



LABORATORIUM MEKANIKA TANAH
FAKULTAS TEKNIK SIPIL DAN PERENCANAAN
UNIVERSITAS ISLAM INDONESIA

Jl. Kaliurang KM 14,5 Telp. (0274) 895042, 895707, fax 895330 Yogyakarta 55584

TRIAXIAL TEST

Project : Tugas Akhir
Location : Cepagan, Pekalongan, Jawa Tengah
Description of soil : Campuran Kapur Karbid 6% (Pemeraman 14 hari)
Depth : 1,20 meter
Date : September 8, 2006
Tested by : Purwadi

Diameter benda uji	3,98 cm
Tinggi benda uji	7,50 cm
Luas mula-mula	12,44 cm ²
Volume benda uji	93,31 cm ³
Berat benda uji	gram
Berat volume tanah	1,579 gr/cm ³
Kalibrasi	0,165

Kadar air	27,71
-----------	-------

Pembacaan beban

Regangan		Luas benda uji			Tekanan sel = 0,25 kg/cm ²			Tekanan sel = 0,5 kg/cm ²			Tekanan sel = 1,00 kg/cm ²		
Pemb. dial	L ₀ a/10 ⁻³	L.L. (%)	koreksi luas	A=luas terkoreksi	Pemb. dial	Beban P (kg)	= P/A (kg/cm ²)	Pemb. dial	Beban P (kg)	= P/A (kg/cm ²)	Pemb. dial	Beban P (kg)	= P/A (kg/cm ²)
(a)	(cm)	(%)	L ₀	[A ₀ (4)]	6	7	8	9	10	11	12	13	14
0	0	0,00	1,000	12,44	0	0,000	0,000	0	0,000	0,000	0	0,000	0,000
20	0,02	0,16	0,998	12,42	103	17,325	1,395	110	18,150	1,461	110	18,150	1,461
40	0,04	0,32	0,997	12,40	140	25,100	1,863	165	27,225	2,195	195	32,175	2,595
60	0,06	0,48	0,995	12,38	160	26,400	2,132	205	33,825	2,732	242	39,950	3,225
80	0,08	0,64	0,994	12,36	175	28,875	2,336	224	36,960	2,990	269	44,385	3,591
100	0,10	0,80	0,993	12,34	190	31,350	2,540	234	38,610	3,129	275	45,375	3,677
120	0,12	0,96	0,990	12,32	210	34,650	2,812	253	40,425	3,281	298	49,170	3,991
140	0,14	1,12	0,989	12,30	222	36,630	2,978	256	42,240	3,434	320	52,800	4,292
160	0,16	1,28	0,988	12,28	226	37,290	3,038	268	44,220	3,601	330	54,450	4,454
180	0,18	1,44	0,986	12,26	230	37,950	3,093	279	46,035	3,733	333	58,375	4,777
200	0,20	1,60	0,984	12,24	233	38,775	3,168	293	48,075	3,976	360	59,400	4,833
220	0,22	1,76	0,982	12,22	248	40,920	3,348	301	49,665	4,064	367	60,535	4,933
240	0,24	1,92	0,981	12,20	250	41,250	3,381	303	50,325	4,123	370	61,050	5,004
260	0,26	2,08	0,979	12,18	255	43,375	3,562	308	50,820	4,172	372	61,350	5,039
280	0,28	2,24	0,977	12,16	254	41,970	3,446	304	50,160	4,125	375	61,875	5,088
300	0,30	2,40	0,976	12,14							374	61,710	5,083



LABORATORIUM MEKANIKA TANAH

FAKULTAS TEKNIK SIPIL DAN PERENCANAAN

UNIVERSITAS ISLAM INDONESIA

Jl. Kaliurang KM 14,5 Telp. (0274) 895042, 895707, fax 895330 Yogyakarta 55584

TRIAxIAL TEST

Project : Final Assignment
 Location : Cepagan, Pekalongan, Jawa Tengah
 Description of soil : Silty Clay + Karbid 6% 14hr(2)

Depth : 1,20 meter
 Date : September 8, 2006
 Tested by : Purwadi

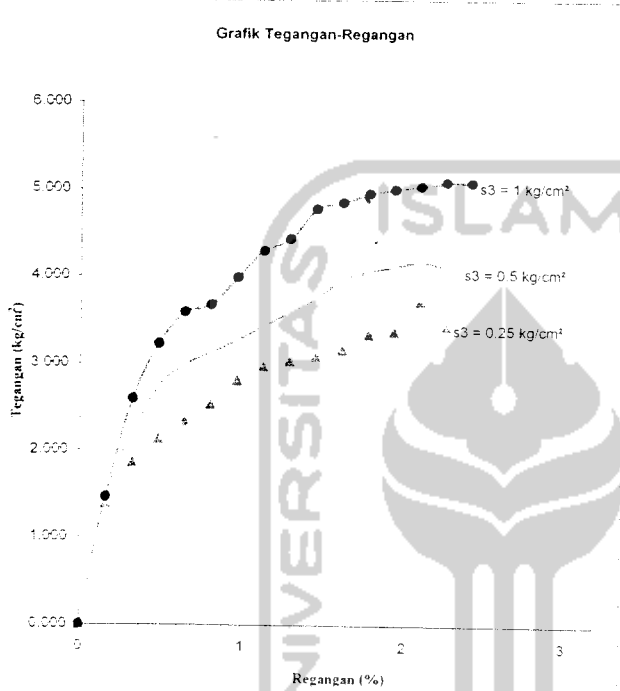

Kadar air

No. Pengujian	1	2
Berat container, gr	0	0
Berat cont. + tanah basah, gr	0	0
Berat cont. + tanah kering, gr	0	0
Kadar air	0.00	0.00
Kadar air rata-rata	27.71	

No. Pengujian	1	2	3
Diameter benda uji, cm	3.98	3.83	3.79
Tinggi benda uji, cm	7.60	7.70	7.64
Luas mula-mula, cm ²	12.44	11.52	11.28
Volume benda uji, cm ³	94.55	88.71	86.19
Berat benda uji, gr	149.49	144.65	147.31
Berat vol. tanah, gr/cm ³	1.581	1.631	1.709
Kalibrasi	0.165		

Brt vol. basah, gr/cm ³	1.581	1.631	1.709
Brt vol. kering, gr/cm ³	1.238	1.277	1.338

σ_3	0.25	0.5	1.0
σ_1/σ_3	3.725	4.172	5.088
σ_1	3.975	4.672	6.088
σ_1/σ_3^2	2.113	2.586	3.577
$(\sigma_1 - \sigma_3)/2$	1.863	2.086	2.577

Sudut gesek dalam (°)	29.22
Nilai kohesi (kg/cm ²)	0.92

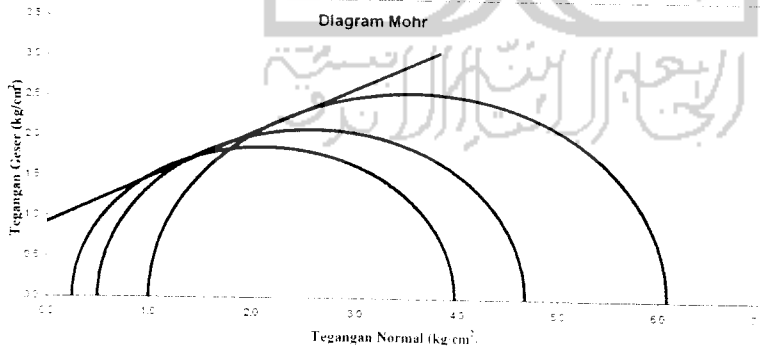

Diperiksa Oleh:

Dr. Ir. Edy Purwanto, CES, DEA



LAMPIRAN 19
Pengujian Triaxial Tanah + Karbid 7.5%



LABORATORIUM MEKANIKA TANAH
FAKULTAS TEKNIK SIPIL DAN PERENCANAAN
UNIVERSITAS ISLAM INDONESIA

Jl. Kaliurang KM 14,5 Telp. (0274) 895042, 895707, fax 895330 Yogyakarta 55584

TRIAXIAL TEST

Project : *Tugas Akhir*
 Location : *Cepagan, Pekalongan, Jawa Tengah*
 Description of soil : *Campuran Kapur Karbid 7,5% (Pemeraman 3 hari)*

Depth : *1,20 meter*
 Date : *September 1, 2006*
 Tested by : *Purwadi*

Diameter benda uji	3,98 cm
Tinggi benda uji	7,50 cm
Luas mula-mula	12,44 cm ²
Volume benda uji	93,31 cm ³
Berat benda uji	gram
Berat volume tanah	1,577 gr/cm ³
Kalibrasi	0,165

Kadar air 27,71

Pembacaan beban

Rezangan		Luas benda uji			Tekanan sel = 0,25 kg/cm ²			Tekanan sel = 0,5 kg/cm ²			Tekanan sel = 1,00 kg/cm ²		
Pemb. dial	$\epsilon = \frac{\Delta L}{L_0}$	koreksi L.L.	A=luas	Pemb dial	Beban P	$\sigma = P/A$	Pemb dial	Beban P	$\sigma = P/A$	Pemb dial	Beban P	$\sigma = P/A$	
(mm)	(%)	(%)	[A ₀ (1- ϵ)]		(kg)	(kg/cm ²)		(kg)	(kg/cm ²)		(kg)	(kg/cm ²)	
1	2	3	4	5	6	8	9	10	11	12	13	14	
0	0,00	1,000	12,44	0	0,000	0,000	0	0,000	0,000	0	0,000	0,000	
20	0,02	0,998	12,42	100	16,500	1,328	110	18,150	1,461	150	24,750	1,995	
40	0,04	0,997	12,40	140	23,100	1,863	170	28,050	2,262	190	31,350	2,528	
60	0,06	0,995	12,38	195	32,175	2,599	201	33,165	2,679	215	35,475	2,865	
80	0,08	0,994	12,36	225	37,125	3,003	235	38,775	3,137	235	38,775	3,137	
100	0,10	0,992	12,34	238	39,270	3,182	245	40,425	3,276	248	40,920	3,316	
120	0,12	0,990	12,32	240	39,600	3,214	248	40,920	3,321	260	42,900	3,482	
140	0,14	0,989	12,30	238	39,270	3,192	256	42,240	3,434	269	44,385	3,608	
160	0,16	0,987	12,28				259	42,735	3,480	276	45,540	3,708	
180	0,18	0,986	12,26				264	43,560	3,553	285	47,025	3,835	
200	0,20	0,984	12,24				269	44,385	3,626	290	47,850	3,909	
220	0,22	0,982	12,22				275	45,375	3,713	296	48,840	3,996	
240	0,24	0,981	12,20				278	45,870	3,760	301	49,665	4,071	
260	0,26	0,979	12,18				280	46,200	3,793	305	50,325	4,131	
280	0,28	0,977	12,16				269	44,385	3,650	308	50,820	4,179	
300	0,30	0,976	12,14							312	51,480	4,240	
320	0,32	0,974	12,12							317	52,305	4,315	
340	0,34	0,973	12,10							324	53,460	4,416	
360	0,36	0,971	12,08							328	54,120	4,480	
380	0,38	0,969	12,06							332	54,780	4,542	
400	0,40	0,968	12,04							335	55,275	4,591	
420	0,42	0,966	12,02							338	55,770	4,639	
440	0,44	0,965	12,00							340	56,100	4,675	
460	0,46	0,963	11,98							341	56,265	4,696	
480	0,48	0,961	11,96							343	56,595	4,732	
500	0,50	0,960	11,94							345	56,925	4,767	
520	0,52	0,958	11,92							347	57,255	4,803	
540	0,54	0,957	11,90							349	57,585	4,839	
560	0,56	0,955	11,88							351	57,915	4,875	
580	0,58	0,953	11,86							353	58,245	4,911	
600	0,60	0,952	11,84							355	58,245	4,919	
620	0,62	0,950	11,82							352	58,080	4,915	
640	0,64	0,949	11,80							354	58,410	4,950	
660	0,66	0,947	11,78							358	59,070	5,014	
680	0,68	0,945	11,76							360	59,400	5,051	
700	0,70	0,944	11,74							361	59,565	5,073	
720	0,72	0,942	11,72							359	59,235	5,052	



LABORATORIUM MEKANIKA TANAH

FAKULTAS TEKNIK SIPIL DAN PERENCANAAN

UNIVERSITAS ISLAM INDONESIA

Jl. Kaliurang KM 14,5 Telp. (0274) 895042, 895707, fax 895330 Yogyakarta 55584

TRIAXIAL TEST

Project : Final Assignment
 Location : Cepagan, Pekalongan, Jawa Tengah
 Description of soil : Silty Clay 7.5% 3hari(1)

Depth : 1,20 meter
 Date : September 1, 2006
 Tested by : Purwadi

Grafik Tegangan-Regangan

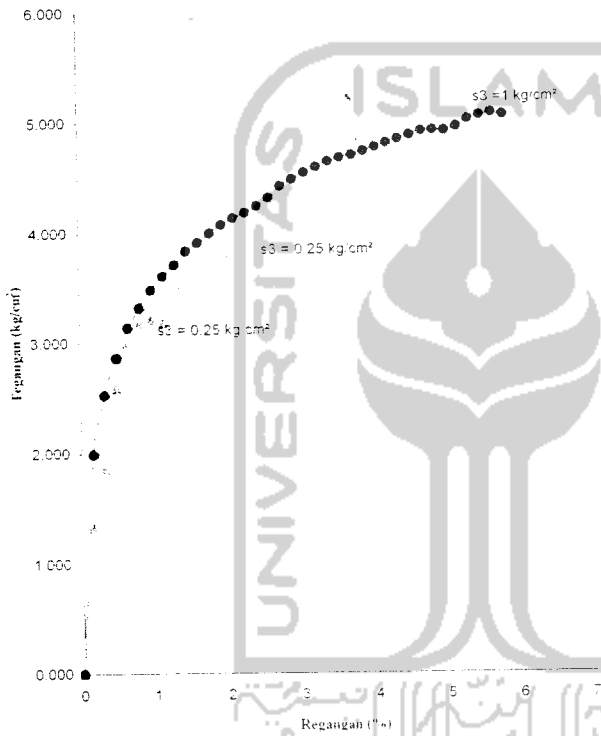

Kadar air

No. Pengujian	1	2
Berat container, gr	0	0
Berat cont. + tanah basah, gr	0	0
Berat cont. + tanah kering, gr	0	0
Kadar air	0.00	0.00
Kadar air rata-rata	27.71	

No. Pengujian	1	2	3
Diameter benda uji, cm	3.98	3.83	3.79
Tinggi benda uji, cm	7.60	7.70	7.64
Luas mula-mula, cm ²	12.44	11.52	11.28
Volume benda uji, cm ³	94.55	88.71	86.19
Berat benda uji, gr	145.49	145.65	147.14
Berat vol. tanah, gr/cm ³	1.539	1.642	1.707
Kalibrasi	0.165		

Brt vol. basah, gr/cm ³	1.539	1.642	1.707
Brt vol. kering, gr/cm ³	1.205	1.286	1.337

σ_3	0.25	0.5	1.0
P/A	3.214	3.793	5.073
$\sigma_1 = \sigma_3 + P$	3.464	4.293	6.073
$(\sigma_1 - \sigma_3)/2$	1.857	2.396	3.537
$(\sigma_1 + \sigma_3)/2$	1.607	1.896	2.537

Sudut gesek dalam (°)	32.87
Nilai kohesi (kg/cm ²)	0.68

Diagram Mohr

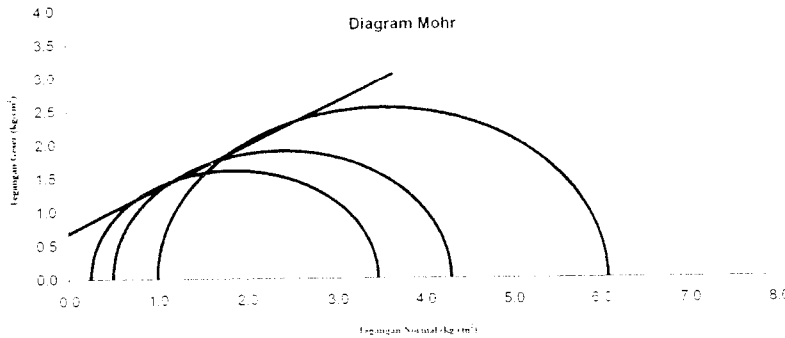

Diperiksa Oleh:

 Dr. Ir. Eddy Purwanto, CES, DEA



LABORATORIUM MEKANIKA TANAH

FAKULTAS TEKNIK SIPIL DAN PERENCANAAN

UNIVERSITAS ISLAM INDONESIA

Jl. Kaliurang KM 14,5 Telp. (0274) 895042, 895707, fax 895330 Yogyakarta 55584

TRIAxIAL TEST

Project : Final Assignment
 Location : Cepagan, Pekalongan, Jawa Tengah
 Description of soil : Silty Clay+karbid 7.5% 3hari(2)

Depth : 1,20 meter
 Date : September 1, 2006
 Tested by : Purwadi

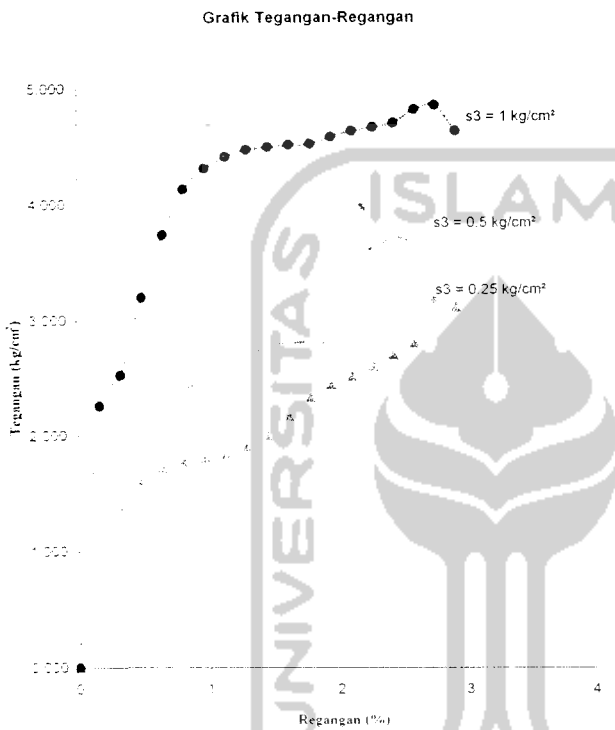

Kadar air

No. Pengujian	1	2
Berat container, gr	0	0
Berat cont. + tanah basah, gr	0	0
Berat cont. + tanah kering, gr	0	0
Kadar air	0.00	0.00
Kadar air rata-rata	27.71	

No. Pengujian	1	2	3
Diameter benda uji, cm	3.98	3.83	3.79
Tinggi benda uji, cm	7.60	7.70	7.64
Luas mula-mula, cm ²	12.44	11.52	11.28
Volume benda uji, cm ³	94.55	88.71	86.19
Berat benda uji, gr	145.62	146.98	148.21
Berat vol. tanah, gr/cm ³	1.540	1.657	1.720
Kalibrasi	0.165		

Brt vol. basah, gr/cm ³	1.540	1.657	1.720
Brt vol. kering, gr/cm ³	1.206	1.297	1.346

σ_3	0.25	0.5	1.0
$\sigma_1 - \sigma_3$	3.197	3.710	4.854
$\sigma_1 - \sigma_3$	3.441	4.210	5.854
$(\sigma_1 - \sigma_3)/2$	1.845	2.355	3.427
$(\sigma_1 + \sigma_3)/2$	1.395	1.835	2.427

Sudut gesek dalam (°)	32.75
Nilai kohesi (kg/cm ²)	0.65

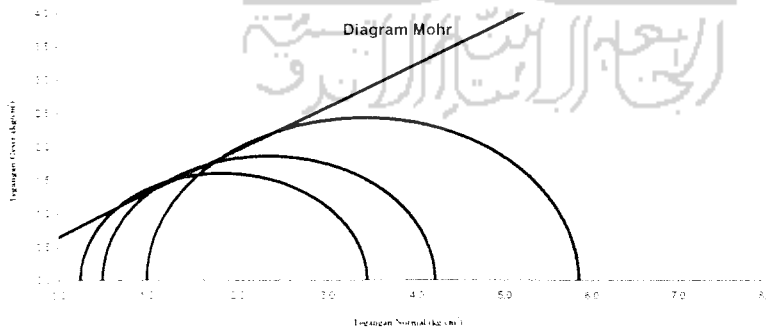

Diperiksa Oleh :

Dr. Ir. Eddy Purwanto.CES.DEA



LABORATORIUM MEKANIKA TANAH

FAKULTAS TEKNIK SIPIL DAN PERENCANAAN

UNIVERSITAS ISLAM INDONESIA

Jl. Kaliurang KM 14,5 Telp. (0274) 895042, 895707, fax 895330 Yogyakarta 55584

TRIAXIAL TEST

Project : Final Assignment
 Location : Cepagan, Pekalongan, Jawa Tengah
 Description of soil : Silty Clay +karbid 7,5%(1)

Depth : 1,20 meter
 Date : September 1, 2006
 Tested by : Purwadi

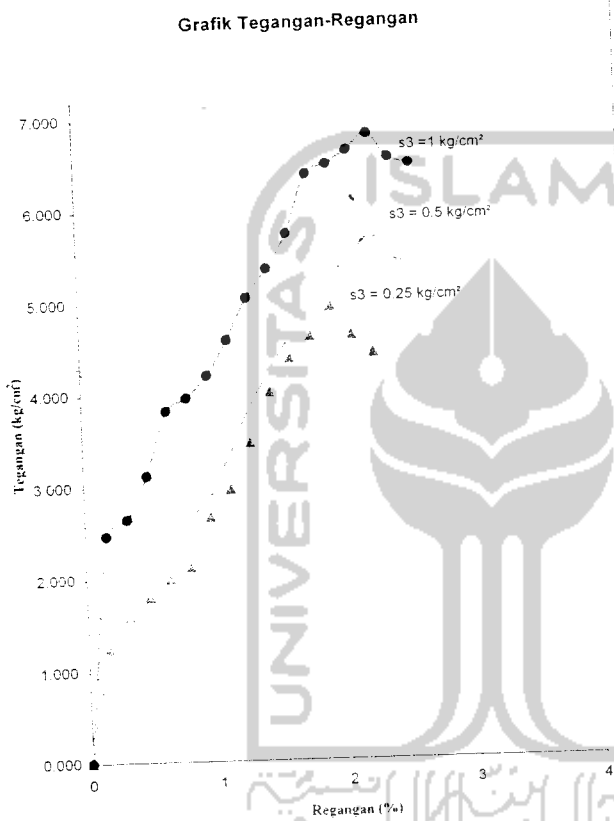

Kadar air

No. Pengujian	1	2
Berat container, gr	0	0
Berat cont. + tanah basah, gr	0	0
Berat cont. + tanah kering, gr	0	0
Kadar air	0.00	0.00
Kadar air rata-rata	27.71	

No. Pengujian	1	2	3
Diameter benda uji, cm	3.98	3.83	3.79
Tinggi benda uji, cm	7.60	7.54	7.42
Luas mula-mula, cm ²	12.44	11.52	11.28
Volume benda uji, cm ³	94.55	86.87	83.71
Berat benda uji, gr	141.55	141.61	142.59
Berat vol. tanah, gr/cm ³	1.497	1.630	1.703
Kalibrasi	0.165		

Brt vol. basah, gr/cm ³	1.497	1.630	1.703
Brt vol. kering, gr/cm ³	1.172	1.276	1.334

s_3	0.25	0.5	1.0
$\sigma_1 = \sigma_2 = \sigma_3$	4.936	5.699	6.798
$\sigma_1 = \sigma_2 + \sigma_3$	5.186	6.199	7.798
$(\sigma_1 + \sigma_3)/2$	2.718	3.349	4.399
$(\sigma_1 - \sigma_3)/2$	2.468	2.849	3.399

Sudut gesek dalam (°)	34.65
Nilai kohesi (kg/cm ²)	1.11

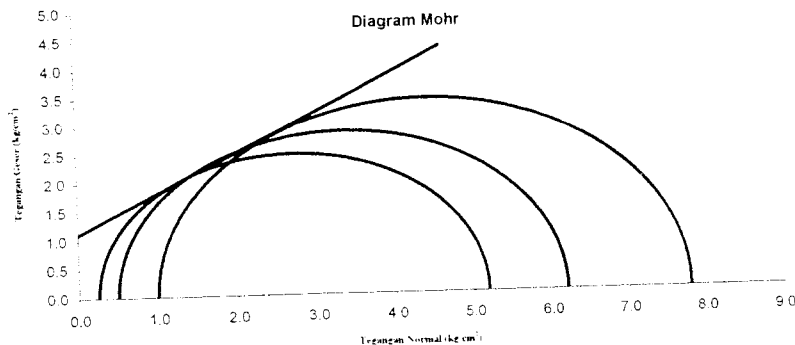

Diperiksa Oleh :

Dr. Ir. Eddy Purwanto, CES, DEA



LABORATORIUM MEKANIKA TANAH

FAKULTAS TEKNIK SIPIL DAN PERENCANAAN

UNIVERSITAS ISLAM INDONESIA

Jl. Kaliurang KM 14,5 Telp. (0274) 895042, 895707, fax 895330 Yogyakarta 55584

TRIAXIAL TEST

Project : Final Assignment
 Location : Cepagan, Pekalongan, Jawa Tengah
 Description of soil : Silty Clay+karbid 7.5% 7hari(2)

Depth : 1,20 meter
 Date : September 1, 2006
 Tested by : Purwadi

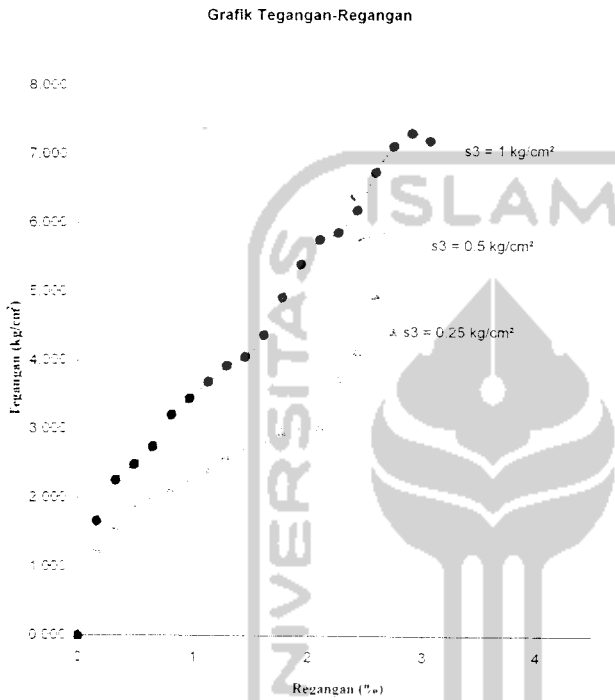

Kadar air

No. Pengujian	1	2
Berat container, gr	0	0
Berat cont. - tanah basah, gr	0	0
Berat cont. - tanah kering, gr	0	0
Kadar air	0.00	0.00
Kadar air rata-rata	27.71	

No. Pengujian	1	2	3
Diameter benda uji, cm	3.98	3.83	3.79
Tinggi benda uji, cm	7.60	7.70	7.64
Luas mula-mula, cm ²	12.44	11.52	11.28
Volume benda uji, cm ³	94.55	88.71	86.19
Berat benda uji, gr	145.62	146.98	148.21
Berat vol tanah, gr/cm ³	1.540	1.657	1.720
Kalibrasi	0.165		

Brt vol. basah, gr/cm ³	1.540	1.657	1.720
Brt vol. kering, gr/cm ³	1.206	1.297	1.346

σ_3	0.25	0.5	1.0
σ_1	4.969	5.918	7.307
σ_2	3.219	6.418	8.307
σ_3	1.734	3.439	4.633
σ_1	2.484	2.939	3.633

Sudut gesek dalam (°)	35.59
Nilai kohesi (kg/cm ²)	1.13

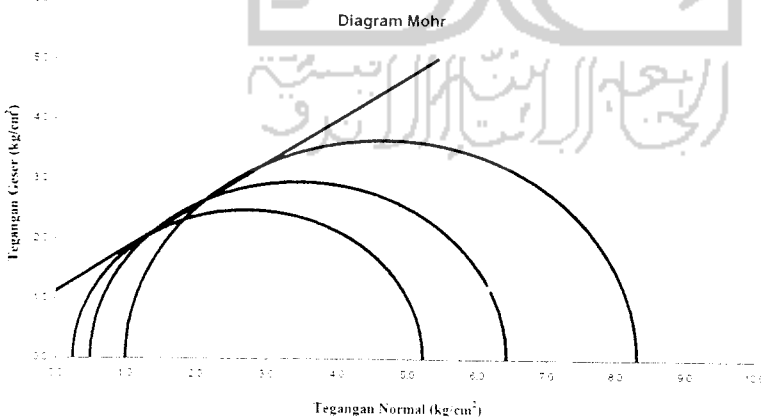

Diperiksa Oleh :

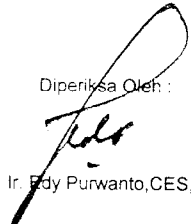
 Dr. Ir. Eddy Purwanto, CES, DEA



LABORATORIUM MEKANIKA TANAH
FAKULTAS TEKNIK SIPIL DAN PERENCANAAN
UNIVERSITAS ISLAM INDONESIA

Jl. Kaliurang KM 14,5 Telp. (0274) 895042, 895707, fax 895330 Yogyakarta 55584

TRIAXIAL TEST

Project : Tugas Akhir
Location : Cepagan, Pekalongan, Jawa Tengah
Description of soil : Campuran Kapur Karbid 7,5% (Pemeraman 14 hari)

Depth : 1,20 meter
Date : September 18, 2006
Tested by : Purwadi

Diameter benda uji	3,98 cm
Tinggi benda uji	7,50 cm
Luas mula-mula	12,44 cm ²
Volume benda uji	93,31 cm ³
Berat benda uji	gram
Berat volume tanah	1,607 gr/cm ³
Kalibrasi	0,165

Kadar air	27,71
-----------	-------

Pembacaan beban

Reaganan		Luas benda uji			Tekanan sel = 0,25 kg/cm ²			Tekanan sel = 0,5 kg/cm ²			Tekanan sel = 1,00 kg/cm ²		
Pemb. dial	L = a ² 10 ⁻³	L L koreksi	A=luas	Pemb dial	Beban P	= P A	Pemb dial	Beban P	= P A	Pemb dial	Beban P	= P A	
(a)	(cm)	(%)	1-e	(kg)	(kg/cm ²)	(kg/cm ²)	(kg)	(kg/cm ²)	(kg/cm ²)	(kg)	(kg/cm ²)	(kg/cm ²)	
0	0	0,00	1,000	12,44	0	0,000	0,000	0	0,000	0,000	0	0,000	
20	0,02	0,16	0,998	12,42	95	15,675	1,262	200	16,500	1,328	130	21,450	
40	0,04	0,32	0,997	12,40	105	17,325	1,397	110	18,150	1,464	185	30,525	
60	0,06	0,48	0,995	12,38	126	20,790	1,679	150	24,750	1,999	225	37,125	
80	0,08	0,64	0,994	12,36	135	22,275	1,802	195	32,175	2,605	250	41,250	
100	0,10	0,80	0,992	12,34	155	25,575	2,072	220	36,300	2,941	280	46,200	
120	0,12	0,96	0,990	12,32	178	29,370	2,384	248	40,920	3,321	305	50,325	
140	0,14	1,13	0,989	12,30	200	33,000	2,683	264	43,560	3,541	325	53,625	
160	0,16	1,29	0,987	12,28	225	37,125	3,023	255	42,075	3,426	335	55,275	
180	0,18	1,45	0,986	12,26	205	33,825	2,759				340	56,100	
200	0,20	1,61	0,984	12,24							346	57,090	
220	0,22	1,77	0,982	12,22							346	57,090	
240	0,24	1,93	0,981	12,20							351	57,915	
260	0,26	2,09	0,979	12,18							352	58,080	
280	0,28	2,25	0,977	12,16							350	57,750	



LABORATORIUM MEKANIKA TANAH

FAKULTAS TEKNIK SIPIL DAN PERENCANAAN

UNIVERSITAS ISLAM INDONESIA

Jl. Kaliurang KM 14,5 Telp. (0274) 895042, 895707, fax 895330 Yogyakarta 55584

TRIAxIAL TEST

Project : Final Assignment
 Location : Cepagan, Pekalongan, Jawa Tengah
 Description of soil : Silty Clay +karbid 7,5% 14hr(1)

Depth : 1,20 meter
 Date : September 18, 2006
 Tested by : Purwadi

Grafik Tegangan-Regangan

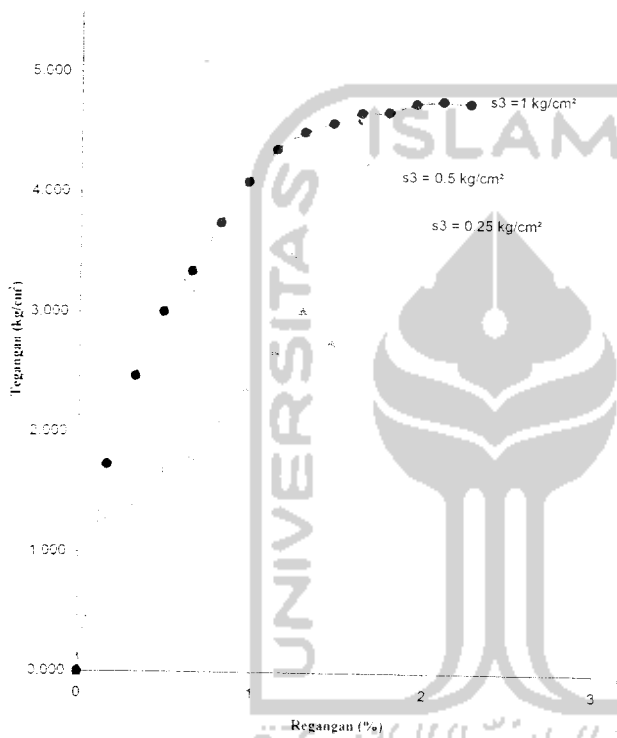

Kadar air

No. Pengujian	1	2
Berat container, gr	0	0
Berat cont. + tanah basah, gr	0	0
Berat cont. + tanah kering, gr	0	0
Kadar air	0.00	0.00
Kadar air rata-rata	27.71	

No. Pengujian	1	2	3
Diameter benda uji, cm	3.98	3.83	3.79
Tinggi benda uji, cm	7.60	7.54	7.42
Luas mula-mula, cm ²	12.44	11.52	11.28
Volume benda uji, cm ³	94.55	86.87	83.71
Berat benda uji, gr	145.02	145.22	149.92
Berat vol tanah, gr/cm ³	1.534	1.672	1.791
Kalibrasi	0.165		

Brk vol. basah, gr/cm ³	1.534	1.672	1.791
Brk vol. kering, gr/cm ³	1.201	1.309	1.402

σ_3	0.25	0.5	1.0
$\sigma_1 - \sigma_3$	3.023	3.541	4.768
$\sigma_1 + \sigma_3$	3.273	4.041	5.768
$(\sigma_1 + \sigma_3)/2$	1.761	2.271	3.384
$(\sigma_1 - \sigma_3)/2$	1.511	1.771	2.384

Sudut gesek dalam (°)	32.47
Nilai kohesi (kg/cm ²)	0.65

Diagram Mohr

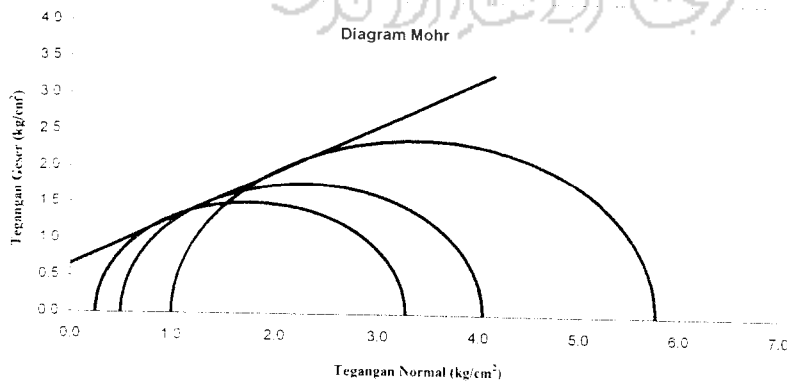

Diperiksa Oleh :

Dr. Ir. Edy Purwanto, CES, DEA



LABORATORIUM MEKANIKA TANAH FAKULTAS TEKNIK SIPIL DAN PERENCANAAN UNIVERSITAS ISLAM INDONESIA

Jl. Kaliurang KM 14,5 Telp. (0274) 895042, 895707, fax 895330 Yogyakarta 55584

TRIAXIAL TEST

Project : Final Assignment
 Location : Cepagan, Pekalongan, Jawa Tengah
 Description of soil : Silty Clay + Karbid 7,5% 14hr(2)

Depth : 1,20 meter
 Date : September 8, 2006
 Tested by : Purwadi

Kadar air

No. Pengujian	1	2
Berat container, gr	0	0
Berat cont. + tanah basah, gr	0	0
Berat cont. + tanah kering, gr	0	0
Kadar air	0,00	0,00
Kadar air rata-rata	27,71	

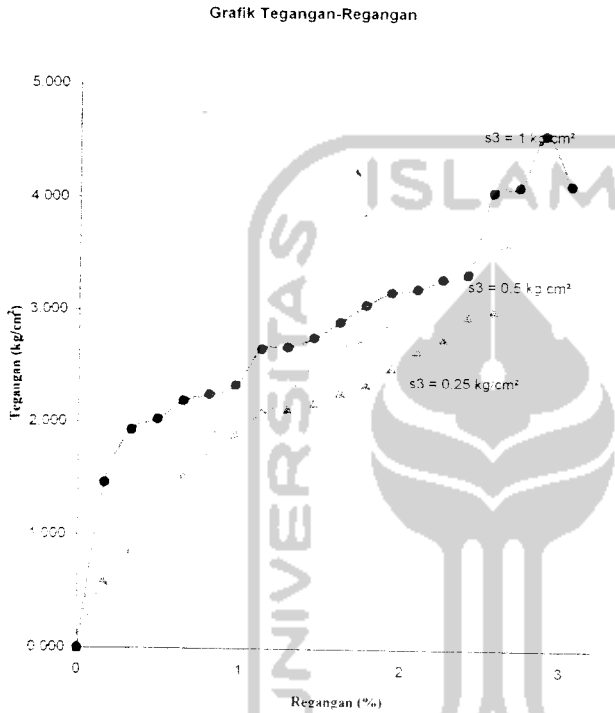

No. Pengujian	1	2	3
Diameter benda uji, cm	3,98	3,83	3,79
Tinggi benda uji, cm	7,60	7,70	7,64
Luas mula-mula, cm ²	12,44	11,52	11,28
Volume benda uji, cm ³	94,55	88,71	86,19
Berat benda uji, gr	147,15	148,64	150,84
Berat vol. tanah, gr/cm ³	1,556	1,676	1,750
Kalibrasi	0,165		

Brt vol. basah, gr/cm	1,556	1,676	1,750
Brt vol. kering, gr/cm ³	1,219	1,312	1,370

σ_3	0,25	0,5	1,0
$\sigma_1 - \sigma_3$	3,008	3,600	4,562
$\sigma_1 + \sigma_3$	3,258	4,100	5,562
$(\sigma_1 - \sigma_3)/2$	1,754	2,300	3,281
$(\sigma_1 + \sigma_3)/2$	1,504	1,800	2,281

Sudut gesek dalam (ϕ)	32,85
Nilai kohesi (c kg/cm ²)	0,61

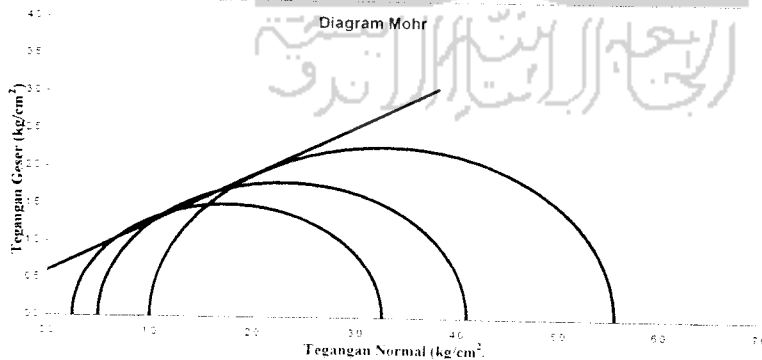

Diperiksa Oleh :

Dr. Ir. Ecy Purwanto, CES, DEA



LAMPIRAN 20
Pengujian Triaxial Tanah + Karbid 10%



LABORATORIUM MEKANIKA TANAH
FAKULTAS TEKNIK SIPIL DAN PERENCANAAN
UNIVERSITAS ISLAM INDONESIA

Jl. Kaliurang KM 14,5 Telp. (0274) 895042, 895707, fax 895330 Yogyakarta 55584

TRIAXIAL

TRIAXIAL TEST

Project : Final Assignment
 Location : Cepagan, Pekalongan, Jawa Tengah
 Description of soil : Silty Clay 10% 3hari(1)

Depth : 1,20 meter
 Date : September 1, 2006
 Tested by : Purwadi

afi
 % (Pemeraman 3 ha

Grafik Tegangan-Regangan

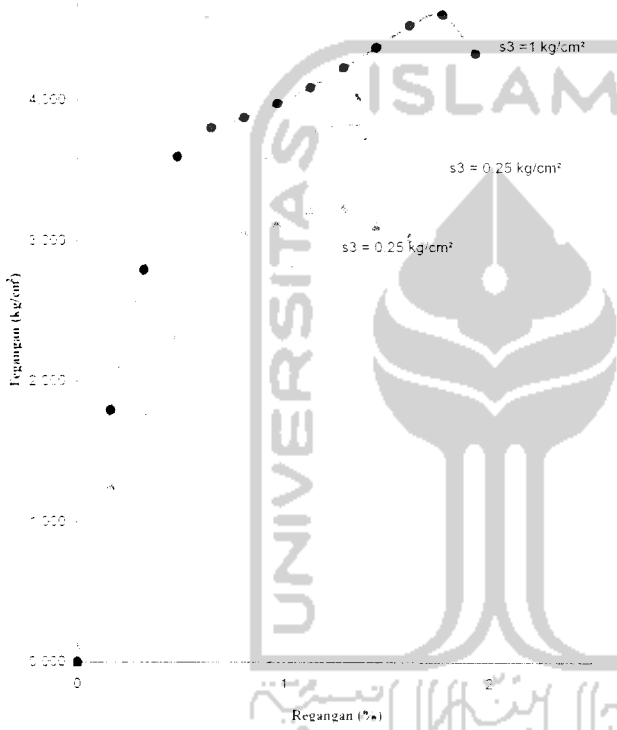

s ₃ = 0,25 kg/cm ²		s ₃ = 0,25 kg/cm ²	
Beban P (kg)	σ ₁ (kg/cm ²)	Beban P (kg)	σ ₁ (kg/cm ²)
7	8	7	8
0.000	0.000	0.000	0.000
1.450	1.727	1.450	1.727
0.325	2.461	0.325	2.461
1.350	2.532	1.350	2.532
2.175	2.603	2.175	2.603
3.165	2.687	3.165	2.687
5.475	2.879	5.475	2.879
7.785	3.072	7.785	3.072
9.435	3.211	9.435	3.211
9.765	3.243	9.765	3.243
8.775	3.168	8.775	3.168

Kadar air

No. Pengujian	1	2
Berat container, gr	0	0
Berat cont. + tanah basah, gr	0	0
Berat cont. + tanah kering, gr	0	0
Kadar air	0.00	0.00
Kadar air rata-rata	27.71	

No. Pengujian	1	2	3
Diameter benda uji, cm	3.98	3.83	3.79
Tinggi benda uji, cm	7.60	7.70	7.64
Luas mula-mula, cm ²	12.44	11.52	11.28
Volume benda uji, cm ³	94.55	88.71	86.19
Berat benda uji, gr	146.85	146.32	146.87
Berat vol. tanah, gr/cm ³	1.553	1.649	1.704
Kalibrasi	0.165		

Brt vol. basah, gr/cm ³	1.553	1.649	1.704
Brt vol. kering, gr/cm ³	1.216	1.292	1.334

	0.25	0.5	1.0
σ ₁ - σ ₃	3.238	3.829	4.604
(σ ₁ + σ ₃)/2	3.488	4.329	5.604
(σ ₁ - σ ₃)/2	1.869	2.415	3.302
(σ ₁ + σ ₃)/2	1.619	1.915	2.302

Sudut gesek dalam (°)	28.39
Nilai kohesi (kg/cm ²)	0.83

Diagram Mohr

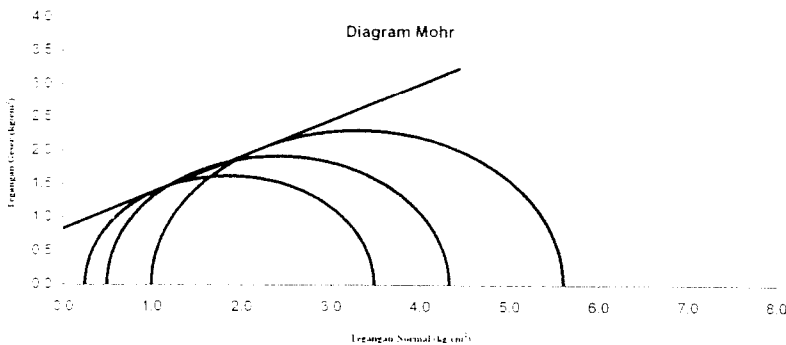

Diperiksa Oleh:

Dr. Ir. Edy Purwanto, CES, DEA



LABORATORIUM MEKANIKA TANAH

FAKULTAS TEKNIK SIPIL DAN PERENCANAAN

UNIVERSITAS ISLAM INDONESIA

Jl. Kaliurang KM 14,5 Telp. (0274) 895042, 895707, fax 895330 Yogyakarta 55584

TRIAXIAL TEST

Project : Final Assignment
 Location : Cepagan, Pekalongan, Jawa Tengah
 Description of soil : Silty Clay+ karbid 10% 3 hari(2)

Depth : 1,20 meter
 Date : September 1, 2006
 Tested by : Purwadi

Grafik Tegangan-Regangan

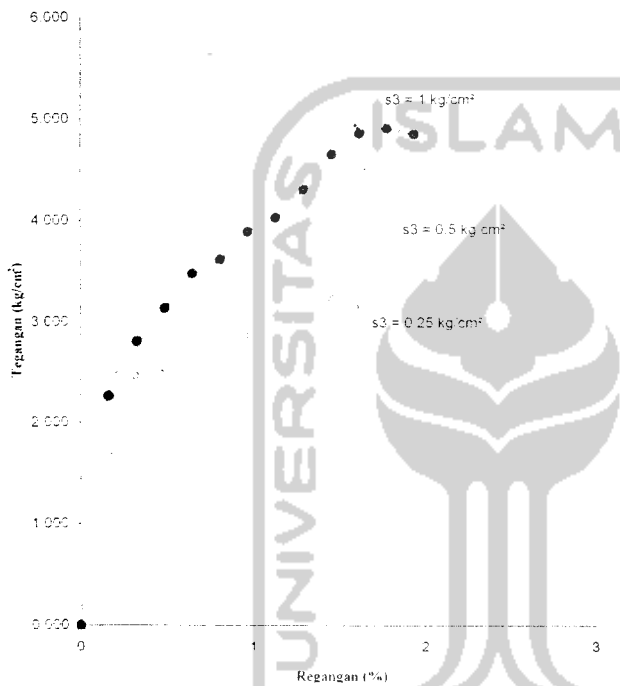

Kadar air

No. Pengujian	1	2
Berat container, gr	0	0
Berat cont. + tanah basah, gr	0	0
Berat cont. + tanah kering, gr	0	0
Kadar air	0.00	0.00
Kadar air rata-rata	27.71	

No. Pengujian	1	2	3
Diameter benda uji, cm	3.98	3.83	3.79
Tinggi benda uji, cm	7.60	7.70	7.64
Luas mula-mula, cm ²	12.44	11.52	11.28
Volume benda uji, cm ³	94.55	88.71	86.19
Berat benda uji, gr	145.62	146.98	148.21
Berat vol tanah, gr/cm ³	1.540	1.657	1.720
Kalibrasi	0.165		

Brt vol. basah, gr/cm	1.540	1.657	1.720
Brt vol. kering, gr/cm ³	1.206	1.297	1.346

	0.25	0.5	1.0
P.A	3.243	3.976	4.901
$(\sigma_1 - \sigma_3) / 2$	3.493	4.476	5.901
$(\sigma_1 + \sigma_3) / 2$	1.872	2.488	3.450
$(\sigma_1 - \sigma_3) / 2$	1.622	1.988	2.350

Sudut gesek dalam (°)	30.65
Nilai kohesi (kg/cm ²)	0.76

Diagram Mohr

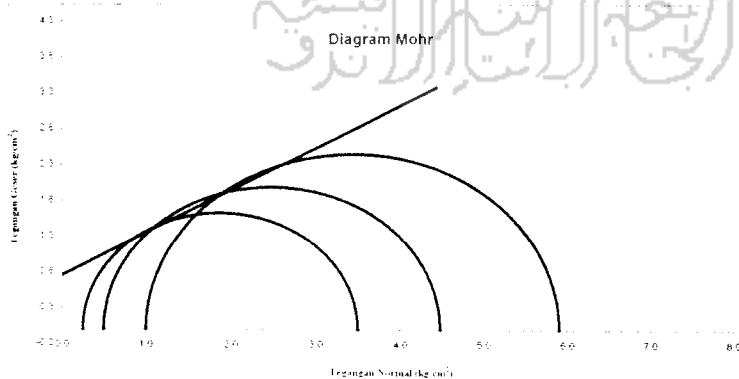

Diperiksa Oleh :

Dr. Ir. Eby Purwanto, CES, DEA



LABORATORIUM MEKANIKA TANAH
FAKULTAS TEKNIK SIPIL DAN PERENCANAAN
UNIVERSITAS ISLAM INDONESIA

Jl. Kaliurang KM 14,5 Telp. (0274) 895042, 895707, fax 895330 Yogyakarta 55584

TRIAXIAL TEST

Project : Tugas Akhir
Location : Cepagan, Pekalongan, Jawa Tengah
Description of soil : Campuran Kapur Karbid 10% (Pemeraman 7 hari)

Depth : 1,20 meter
Date : September 1, 2006
Tested by : Purwadi

Diameter benda uji	3,98 cm
Tinggi benda uji	7,50 cm
Luas mula-mula	12,44 cm ²
Volume benda uji	93,31 cm ³
Berat benda uji	gram
Berat volume tanah	1,556 gr cm ³
Kalibrasi	0,165

Kadar air	27,71
-----------	-------

Pembacaan beban

Regangan					Tekanan sel = 0,25 kg/cm ²			Tekanan sel = 0,5 kg/cm ²			Tekanan sel = 1,00 kg/cm ²		
Pemb. dial	$\frac{l}{a} \cdot 10^3$	koreksi	Luas	A=luas	Pemb. dial	Beban P (kg)	= P/A (kg/cm ²)	Pemb. dial	Beban P (kg)	= P/A (kg/cm ²)	Pemb. dial	Beban P (kg)	= P/A (kg/cm ²)
(a)	(cm)	(%)	1-c	(Ac(1-c))	6	7	8	9	10	11	12	13	14
0	0	0,00	1,000	12,44	0	0,000	0,000	0	0,000	0,000	0	0,000	0,000
20	0,02	0,16	0,998	12,42	95	15,675	1,262	85	14,025	1,129	90	14,850	1,196
40	0,04	0,32	0,997	12,40	120	19,800	1,597	120	19,800	1,597	121	19,965	1,610
60	0,06	0,48	0,995	12,38	135	22,275	1,799	140	23,100	1,866	149	24,555	1,986
80	0,08	0,64	0,994	12,36	150	24,750	2,002	157	25,905	2,096	195	32,175	2,603
100	0,10	0,80	0,992	12,34	159	26,235	2,126	168	27,720	2,246	201	33,165	2,687
120	0,12	0,96	0,990	12,32	144	23,760	1,928	174	28,710	2,330	240	39,600	3,214
140	0,14	1,12	0,989	12,30	145	23,925	1,945	175	28,875	2,347	275	43,375	3,689
160	0,16	1,28	0,987	12,28	145	23,925	1,948	189	31,185	2,539	295	48,675	3,963
180	0,18	1,44	0,986	12,26	146	24,090	1,965	195	32,175	2,624	310	51,150	4,172
200	0,20	1,60	0,984	12,24	151	24,915	2,035	204	33,660	2,750	312	51,480	4,206
220	0,22	1,76	0,982	12,22	150	24,750	2,025	209	34,485	2,822	315	51,975	4,253
240	0,24	1,92	0,981	12,20				211	34,815	2,853	315	51,975	4,260
260	0,26	2,08	0,979	12,18				210	34,650	2,845	311	51,315	4,213



LABORATORIUM MEKANIKA TANAH

FAKULTAS TEKNIK SIPIL DAN PERENCANAAN

UNIVERSITAS ISLAM INDONESIA

Jl. Kaliurang KM 14,5 Telp. (0274) 895042, 895707, fax 895330 Yogyakarta 55584

TRIAXIAL TEST

Project : Final Assignment
 Location : Cepagan, Pekalongan, Jawa Tengah
 Description of soil : Silty Clay +karbid 10% 7hr(1)

Depth : 1,20 meter
 Date : September 1, 2006
 Tested by : Purwadi

Grafik Tegangan-Regangan

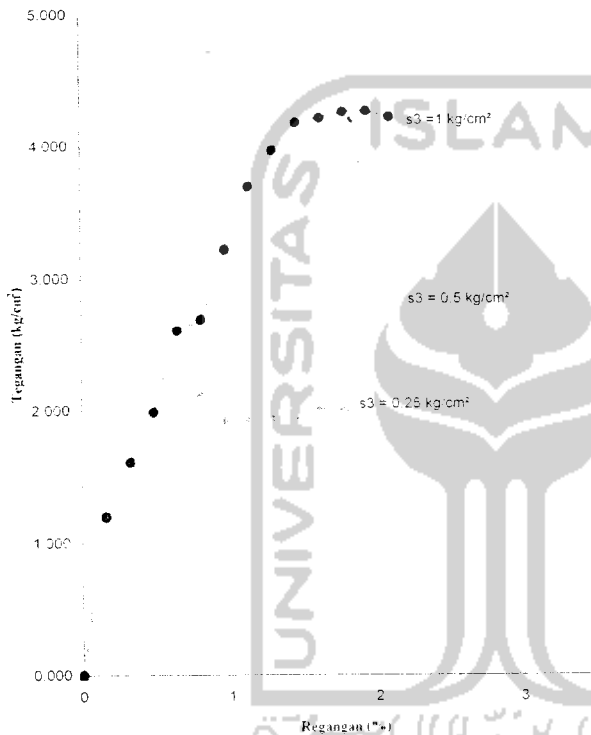

Kadar air

No. Pengujian	1	2
Berat container, gr	0	0
Berat cont. + tanah basah, gr	0	0
Berat cont. + tanah kering, gr	0	0
Kadar air	0.00	0.00
Kadar air rata-rata	27.71	

No. Pengujian	1	2	3
Diameter benda uji, cm	3.98	3.83	3.79
Tinggi benda uji, cm	7.60	7.54	7.42
Luas mula-mula, cm ²	12.44	11.52	11.28
Volume benda uji, cm ³	94.55	86.87	83.71
Berat benda uji, gr	142.38	143.00	145.19
Berat vol.tanah, gr/cm ³	1.506	1.646	1.734
Kalibrasi	0.165		

Brt vol. basah, gr/cm ³	1.506	1.646	1.734
Brt vol. kering, gr/cm ³	1.179	1.289	1.358

σ_1	0.25	0.5	1.0
P/A	2.126	2.853	4.260
$\sigma_1 + \sigma_3$	2.376	3.353	5.260
$(\sigma_1 + \sigma_3)/2$	1.515	1.927	3.130
$(\sigma_1 - \sigma_3)/2$	1.063	1.427	2.130

Sudut gesek dalam (°)	35.48
Nilai kohesi (kg/cm ²)	0.37

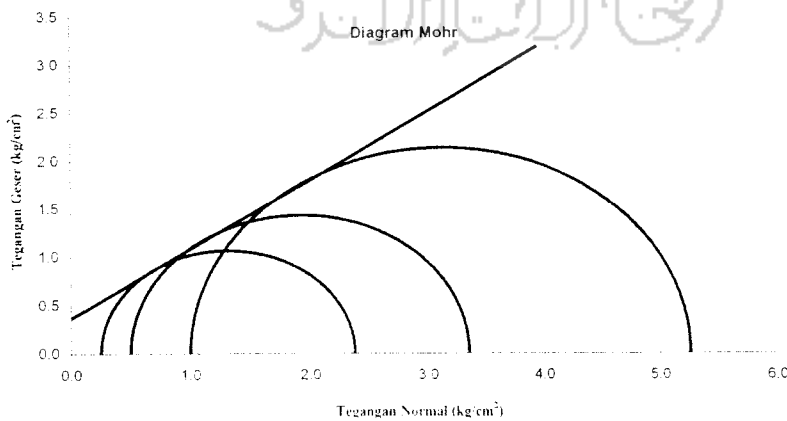

Diperiksa Oleh :

Dr. Ir. Eby Purwanto, CES, DEA



LABORATORIUM MEKANIKA TANAH
FAKULTAS TEKNIK SIPIL DAN PERENCANAAN
UNIVERSITAS ISLAM INDONESIA

Jl. Kaliurang KM 14,5 Telp. (0274) 895042, 895707, fax 895330 Yogyakarta 55584

TRIAXIAL TEST

Project : Tugas Akhir

Location : Cepagan, Pekalongan, Jawa Tengah

Description of soil : Campuran Kapur Karbid 10% (Pemeraman 7 hari)2

Depth : 1,20 meter

Date : September 1, 2006

Tested by : Purwadi

Diameter benda uji	3.98 cm
Tinggi benda uji	7.50 cm
Luas mula-mula	12.44 cm ²
Volume benda uji	93.31 cm ³
Berat benda uji	gram
Berat volume tanah	1.606 gr/cm ³
Kalibrasi	0.165

Kadar air	27.71
-----------	-------

Pembacaan beban

Regangan		Luas benda uji			Tekanan sel = 0,25 kg/cm ²			Tekanan sel = 0,5 kg/cm ²			Tekanan sel = 1,00 kg/cm ²		
Pemb dial	L = a 10 ⁻³	L L	koreksi luas	A- luas	Pemb dial	Beban P	= P/A	Pemb dial	Beban P	= P/A	Pemb dial	Beban P	= P/A
(a)	(cm)	(%)	1-e	[Aof(4)]		(kg)	(kg/cm ²)		(kg)	(kg/cm ²)		(kg)	(kg/cm ²)
1	2	3	4	5	6	7	8	9	10	11	12	13	14
0	0.00	0.00	1.000	12.44	0	0.000	0.000	0	0.000	0.000	0	0.000	0.000
20	0.02	0.16	0.995	12.42	90	24.850	1.996	95	15.675	1.262	110	18.150	1.461
40	0.04	0.32	0.995	12.40	130	27.450	2.210	135	22.275	1.796	155	25.575	2.062
60	0.06	0.48	0.995	12.38	139	22.935	1.852	142	23.450	1.892	225	37.125	2.999
80	0.08	0.64	0.994	12.36	152	25.080	2.029	155	30.525	2.488	235	38.775	3.137
100	0.10	0.80	0.992	12.34	164	27.060	2.193	205	33.825	2.742	247	40.755	3.302
120	0.12	0.96	0.990	12.32	181	29.865	2.424	210	34.650	2.852	258	42.570	3.455
140	0.14	1.12	0.989	12.30	187	30.855	2.508	215	35.475	2.884	261	43.065	3.501
160	0.16	1.28	0.987	12.28	185	30.525	2.486	218	35.970	2.929	265	43.725	3.560
180	0.18	1.44	0.986	12.26				221	36.465	2.974	271	44.715	3.647
200	0.20	1.60	0.984	12.24				234	38.610	3.154	276	45.540	3.720
220	0.22	1.76	0.982	12.22				204	33.660	2.754	281	46.365	3.794
240	0.24	1.92	0.981	12.20				203	33.495	2.745	290	47.850	3.922
260	0.26	2.09	0.979	12.18							298	49.170	4.037
280	0.28	2.25	0.977	12.16							302	49.830	4.098
300	0.30	2.41	0.976	12.14							308	50.820	4.186
320	0.32	2.57	0.974	12.12							314	51.810	4.274
340	0.34	2.73	0.973	12.10							325	53.625	4.431
360	0.36	2.89	0.971	12.08							310	51.150	4.234



LABORATORIUM MEKANIKA TANAH
FAKULTAS TEKNIK SIPIL DAN PERENCANAAN
UNIVERSITAS ISLAM INDONESIA

Jl. Kaliurang KM 14,5 Telp. (0274) 895042, 895707, fax 895330 Yogyakarta 55584

TRIAXIAL TEST

Project : Final Assignment
Location : Cepagan, Pekalongan, Jawa Tengah
Description of soil : Silty Clay + Karbid 10% 7hari(2)

Depth : 1,20 meter
Date : September 1, 2006
Tested by : Purwadi

Kadar air

No. Pengujian	1	2
Berat container, gr	0	0
Berat cont. + tanah basah, gr	0	0
Berat cont. + tanah kering, gr	0	0
Kadar air	0.00	0.00
Kadar air rata-rata	27.71	

Grafik Tegangan-Regangan

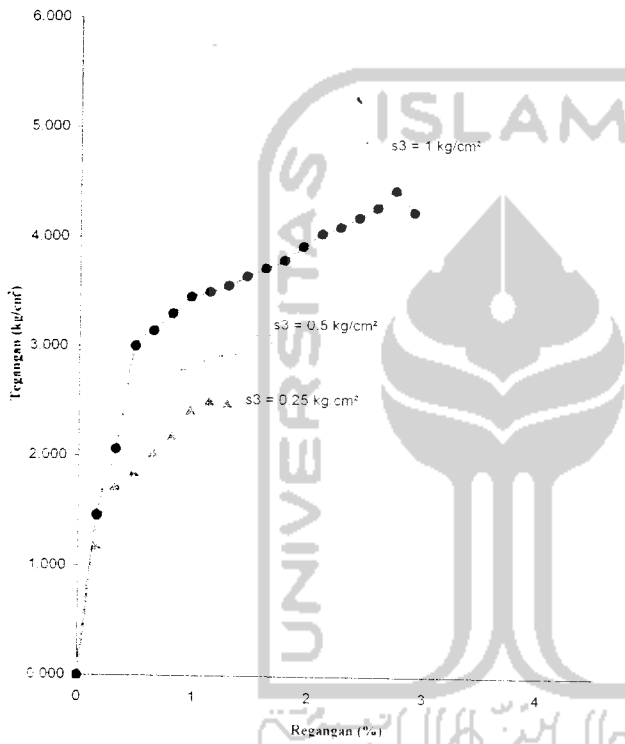

No. Pengujian	1	2	3
Diameter benda uji, cm	3.98	3.83	3.79
Tinggi benda uji, cm	7.60	7.70	7.64
Luas mula-mula, cm ²	12.44	11.52	11.28
Volume benda uji, cm ³	94.55	88.71	86.19
Berat benda uji, gr	144.85	145.19	149.85
Berat vol. tanah, gr cm ³	1.532	1.637	1.739
Kalibrasi	0.165		

Brt vol. basah, gr/cm ³	1.532	1.637	1.739
Brt vol. kering, gr/cm ³	1.200	1.282	1.361

σ_3	0.25	0.5	1.0
P/A	2.508	3.154	4.431
$(\sigma_1 + \sigma_3)$	2.758	3.654	5.431
$(\sigma_1 + \sigma_3)/2$	1.504	2.077	3.216
$(\sigma_1 - \sigma_3)/2$	1.254	1.577	2.216

Sudut gesek dalam ($^\circ$)	33.67
Nilai kohesi (kg/cm^2)	0.50

Diagram Mohr

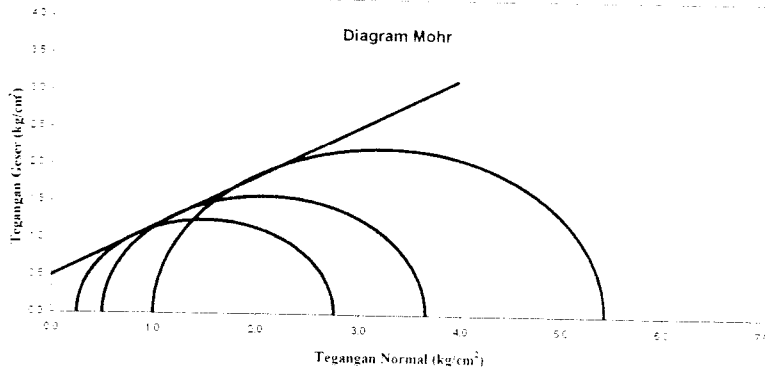

Diperiksa Oleh:

Dr. Ir. Epy Purwanto, CES, DEA



LABORATORIUM MEKANIKA TANAH
FAKULTAS TEKNIK SIPIL DAN PERENCANAAN
UNIVERSITAS ISLAM INDONESIA

Jl. Kaliurang KM 14,5 Telp. (0274) 895042, 895707, fax 895330 Yogyakarta 55584

TRIAxIAL TEST

Project : Tugas Akhir
Location : Cepagan, Pekalongan, Jawa Tengah
Description of soil : Campuran Kapur Karbid 10% (Pemeraman 14 hari)

Depth : 1,20 meter
Date : September 18, 2006
Tested by : Purwadi

Diameter benda uji	3.98 cm
Tinggi benda uji	7.50 cm
Luas mula-mula	12.44 cm ²
Volume benda uji	93.31 cm ³
Berat benda uji	- gram
Berat volume tanah	1.607 gr/cm ³
Kalibrasi	0.165

Kadar air : 27.71

Pembacaan beban

Regangan		Luas benda uji			Tekanan sel = 0.25 kg/cm ²			Tekanan sel = 0.5 kg/cm ²			Tekanan sel = 1.00 kg/cm ²		
Pemb. dial	L = a/10 ⁻³	L/L	koreksi luas	A=luas terkoreksi [Aof(4)]	Pemb. dial	Beban P (kg)	= P/A (kg/cm ²)	Pemb. dial	Beban P (kg)	= P/A (kg/cm ²)	Pemb. dial	Beban P (kg)	= P/A (kg/cm ²)
(a)	(cm)	(%)	1-c	[Aof(4)]	6	7	8	9	10	11	12	13	14
0	0	0.00	1.000	12.44	0	0.000	0.000	0	0.000	0.000	0	0.000	0.000
20	0.02	0.16	0.998	12.42	40	6.600	0.531	45	7.425	0.598	50	8.250	0.664
40	0.04	0.32	0.997	12.40	65	10.725	0.865	70	11.550	0.931	105	17.325	1.397
60	0.06	0.48	0.995	12.38	85	14.025	1.133	125	20.625	1.666	130	29.700	2.399
80	0.08	0.64	0.994	12.36	145	23.925	1.936	185	30.525	2.469	260	42.900	3.471
100	0.10	0.80	0.992	12.34	200	33.000	2.674	254	38.610	3.129	310	51.150	4.145
120	0.12	0.96	0.990	12.32	245	40.425	3.281	272	43.880	3.643	360	59.400	4.821
140	0.14	1.12	0.989	12.30	264	43.560	3.541	297	49.005	3.984	395	65.175	5.298
160	0.16	1.29	0.987	12.28	275	45.375	3.695	311	51.315	4.178	414	68.310	5.562
180	0.18	1.45	0.986	12.26	288	47.520	3.876	320	52.800	4.306	425	70.125	5.719
200	0.20	1.61	0.984	12.24	289	47.685	3.896	325	53.625	4.381	430	70.950	5.796
220	0.22	1.77	0.982	12.22	290	47.850	3.915	345	56.925	4.658	435	71.775	5.873
240	0.24	1.93	0.981	12.20	287	47.355	3.881	341	56.265	4.611	438	72.270	5.923
260	0.26	2.09	0.979	12.18							440	72.600	5.960
280	0.28	2.25	0.977	12.16							442	72.930	5.997
300	0.30	2.41	0.976	12.14							445	73.095	6.020
320	0.32	2.57	0.974	12.12							445	73.095	6.030
340	0.34	2.73	0.973	12.10							444	73.260	6.054
360	0.36	2.89	0.971	12.08							443	73.095	6.050



LABORATORIUM MEKANIKA TANAH FAKULTAS TEKNIK SIPIL DAN PERENCANAAN UNIVERSITAS ISLAM INDONESIA

Jl. Kaliurang KM 14,5 Telp. (0274) 895042, 895707, fax 895330 Yogyakarta 55584

TRIAXIAL TEST

Project : Final Assignment
 Location : Cepagan, Pekalongan, Jawa Tengah
 Description of soil : Silty Clay +karbid 10% 14hr(1)

Depth : 1,20 meter
 Date : September 18, 2006
 Tested by : Purwadi

Grafik Tegangan-Regangan

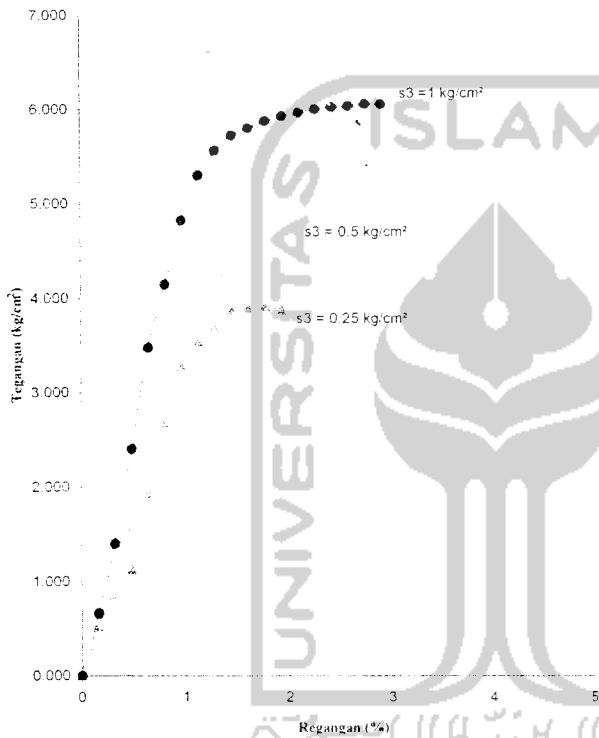

Kadar air

No. Pengujian	1	2
Berat container, gr	0	0
Berat cont. + tanah basah, gr	0	0
Berat cont. + tanah kering, gr	0	0
Kadar air	0.00	0.00
Kadar air rata-rata	27.71	

No. Pengujian	1	2	3
Diameter benda uji, cm	3.98	3.83	3.79
Tinggi benda uji, cm	7.60	7.54	7.42
Luas mula-mula, cm ²	12.44	11.52	11.28
Volume benda uji, cm ³	94.55	86.87	83.71
Berat benda uji, gr	144.75	145.67	149.92
Berat vol tanah, gr/cm ³	1.531	1.677	1.791
Kalibrasi	0.165		

Brt vol. basah, gr/cm ³	1.531	1.677	1.791
Brt vol. kering, gr/cm ³	1.190	1.313	1.402

	0.25	0.5	1.0
P/A	3.915	4.658	6.054
(σ ₁ - σ ₃)/2	4.165	5.158	7.054
(σ ₁ + σ ₃)/2	2.208	2.829	4.027
(σ ₁ - σ ₃)/2	1.958	2.329	3.027

Sudut gesek dalam (°)	36.63
Nilai kohesi (kg/cm ²)	0.78

Diagram Mohr

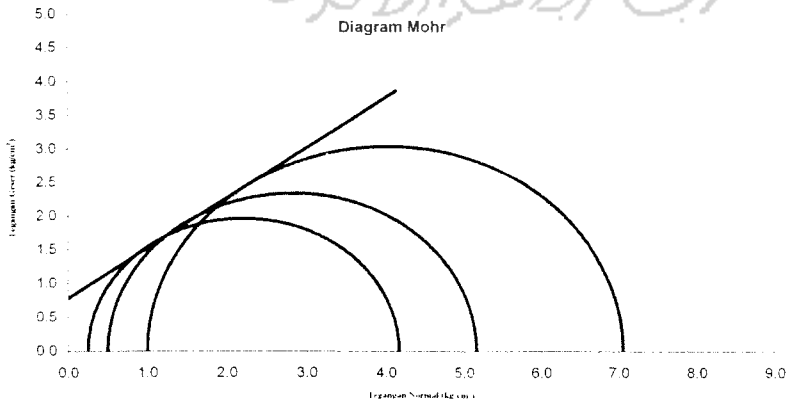

Diperiksa Oleh:

[Signature]
 Dr. Ir. Ety Purwanto, CES, DEA



LABORATORIUM MEKANIKA TANAH
FAKULTAS TEKNIK SIPIL DAN PERENCANAAN
UNIVERSITAS ISLAM INDONESIA

Jl. Kaliurang KM 14,5 Telp. (0274) 895042, 895707, fax 895330 Yogyakarta 55584

TRIAXIAL TEST

Project : Tugas Akhir
Location : Cepagan, Pekalongan, Jawa Tengah
Description of soil : Campuran Kapur Karbid 10% (Pemeraman 14 hari)²

Depth : 1,20 meter
Date : September 8, 2006
Tested by : Purwadi

Diameter benda uji	3.98 cm
Tinggi benda uji	7.50 cm
Luas mula-mula	12.44 cm ²
Volume benda uji	93.31 cm ³
Berat benda uji	gram
Berat volume tanah	1.668 gr/cm ³
Kalibrasi	0.165

Kadar air	27.71
-----------	-------

Pembacaan beban

Regangan		Luas benda uji			Tekanan sel = 0,25 kg/cm ²			Tekanan sel = 0,5 kg/cm ²			Tekanan sel = 1,00 kg/cm ²		
Pemb. dial	L = a/10 ⁻³	koreksi L/L	A=luas	Pemb. dial	Beban P	= P/A	Pemb. dial	Beban P	= P/A	Pemb. dial	Beban P	= P/A	
(a)	(cm)	(%)	terkoreksi	(kg)	(kg/cm ²)	(kg/cm ²)	(kg)	(kg/cm ²)	(kg/cm ²)	(kg)	(kg/cm ²)	(kg/cm ²)	
1	2	3	4	5	6	7	8	9	10	11	12	13	14
0	0	0.00	1.000	12.44	0	0.000	0.000	0	0.000	0.000	0	0.000	0.000
20	0.02	0.16	0.998	12.42	85	14.025	1.129	95	15.675	1.262	110	18.150	1.461
40	0.04	0.32	0.997	12.40	110	18.150	1.464	140	23.100	1.863	145	23.925	1.929
60	0.06	0.48	0.995	12.38	116	19.140	1.546	190	31.350	2.532	198	32.670	2.639
80	0.08	0.64	0.994	12.36	210	34.650	2.803	245	40.425	3.270	255	38.775	3.137
100	0.10	0.80	0.992	12.34	242	39.930	3.236	250	41.250	3.343	251	41.415	3.356
120	0.12	0.96	0.990	12.32	268	44.220	3.589	295	48.675	3.951	295	48.675	3.951
140	0.14	1.12	0.989	12.30	285	47.025	3.823	305	50.325	4.091	305	50.325	4.091
160	0.16	1.28	0.987	12.28	295	48.675	3.963	328	54.120	4.407	344	56.760	4.622
180	0.18	1.44	0.986	12.26	290	47.850	3.903	340	56.100	4.575	345	56.925	4.643
200	0.20	1.60	0.984	12.24				343	56.595	4.623	385	63.525	5.190
220	0.22	1.76	0.982	12.22				350	57.450	4.635	400	66.000	5.401
240	0.24	1.92	0.981	12.20							415	68.475	5.612
260	0.26	2.08	0.979	12.18							425	70.125	5.755
280	0.28	2.24	0.977	12.16							430	70.950	5.834
300	0.30	2.40	0.976	12.14							428	70.620	5.817



LABORATORIUM MEKANIKA TANAH

FAKULTAS TEKNIK SIPIL DAN PERENCANAAN

UNIVERSITAS ISLAM INDONESIA

Jl. Kaliurang KM 14,5 Telp. (0274) 895042, 895707, fax 895330 Yogyakarta 55584

TRIAXIAL TEST

Project : Final Assignment
 Location : Cepagan, Pekalongan, Jawa Tengah
 Description of soil : Silty Clay + Karbid 10% 14hr(2)

Depth : 1,20 meter
 Date : September 8, 2006
 Tested by : Purwadi

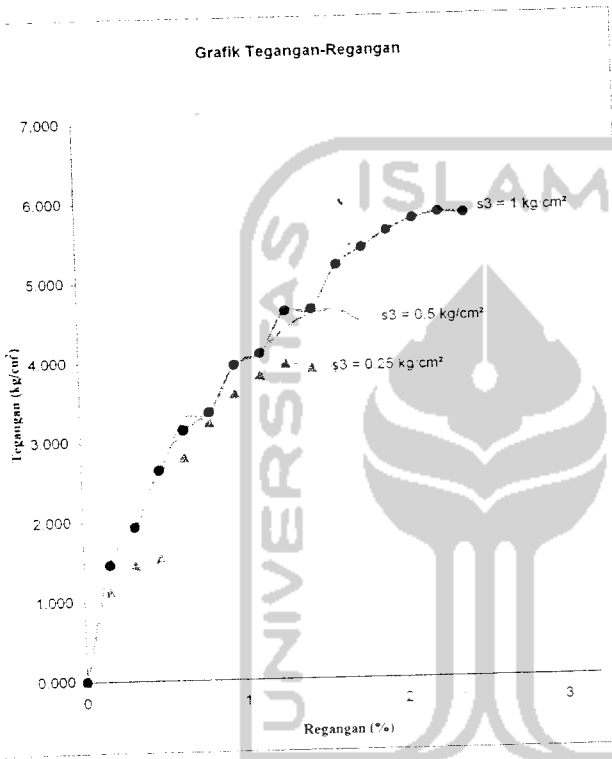

No. Pengujian	1	2
Berat container, gr	0	0
Berat cont. + tanah basah, gr	0	0
Berat cont. + tanah kering, gr	0	0
Kadar air	0.00	0.00
Kadar air rata-rata	27.71	

No. Pengujian	1	2	3
Diameter benda uji, cm	3.98	3.83	3.79
Tinggi benda uji, cm	7.60	7.70	7.64
Luas mula-mula, cm ²	12.44	11.52	11.28
Volume benda uji, cm ³	94.55	88.71	86.19
Berat benda uji, gr	148.98	152.05	155.60
Berat vol. tanah, gr/cm ³	1.576	1.714	1.805
Kalibrasi	0.163		

Brt vol. basah, gr/cm ³	1.576	1.714	1.805
Brt vol. kering, gr/cm ³	1.234	1.342	1.414

σ_3	0.25	0.5	1.0
$\sigma_1 = P/A$	3.963	4.623	5.834
$\sigma_1 = 2\sigma_3 + \sigma_3$	4.213	5.123	6.834
$(\sigma_1 + \sigma_3)/2$	2.232	2.812	3.917
$(\sigma_1 - \sigma_3)/2$	1.982	2.312	2.917

Sudut gesek dalam (°)	33.17
Nilai kohesi (kg/cm ²)	0.91

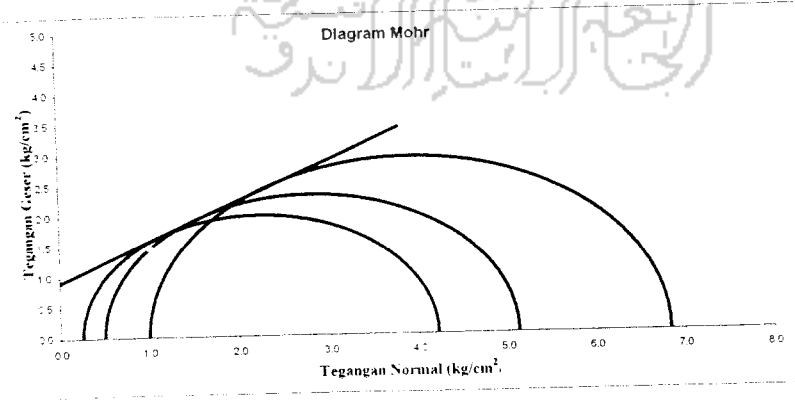

Diperiksa Oleh:

 Dr. Ir. Eddy Purwanto, CES, DEA



LAMPPIRAN 21

Analisis Kuat Dukung Tanah dengan Metode Vesic

Analisis Kuat Dukung Tanah dengan metode Vesic
Triaxial Pemeraman 7 hari

	Undisturb	karbid 1.5%	karbid 3%	karbid 4.5%	karbid 6%	karbid 7.5%	karbid 10%
P	25	25	25	25	25	25	25
Asu	2	2	2	2	2	2	2
SF	2.5	2.5	2.5	2.5	2.5	2.5	2
Df	1.2	1.2	1.2	1.2	1.2	1.2	2.5
t	0.3	0.3	0.3	0.3	0.3	0.3	1.2
Y	1.737	1.643	1.627	1.661	1.64	1.623	0.3
Po	2.3133	2.2287	2.2143	2.2449	2.226	2.2107	1.632
koh	1.3	8.7	8.5	3.9	7.2	11.2	2.2188
sud	12.08	26.42	33.53	38.37	28.03	35.12	4.4
Nc	9.38	22.98	40.5	63.87	26.01	46.99	34.58
Nq	3.09	12.36	27.98	51.68	14.89	33.85	44.65
NY	1.75	13.35	38.69	84.87	16.98	48.96	31.96
Sc	1.3294	1.5379	1.6892	1.8091	1.5725	1.7204	44.62
Sq	1.2140	1.4968	1.6626	1.7917	1.5324	1.7033	1.7158
Sy	0.6	0.6	0.6	0.6	0.6	0.6	1.6893
dc	1.24	1.24	1.24	1.24	1.24	1.24	0.6
dq	1.161	1.184	1.159	1.137	1.179	1.152	1.24
dy	1	1	1	1	1	1	1.155
ic =	1	1	1	1	1	1	1
bc =	1	1	1	1	1	1	1
gc =	1	1	1	1	1	1	1
qu	31.997	13.215	880.025	879.660	441.771	1317.252	600.004
qa	12.799	77.286	352.010	351.864	176.709	526.901	240.001
qn	10.485	75.057	349.796	349.619	174.483	524.690	237.783
Cek							
qn =							
B	1.743	0.427	0.302	0.302	0.427	0.246	0.366
B baru	2.00	0.5	0.4	0.4	0.5	0.3	0.4
qu	31.997	433.345	849.010	811.995	429.240	1276.727	565.050
qa	12.80	173.34	339.92	324.80	171.70	510.69	226.02
Ce							
q te							
P i							
q t							
amb							
P t							
q t							
Pc							

